

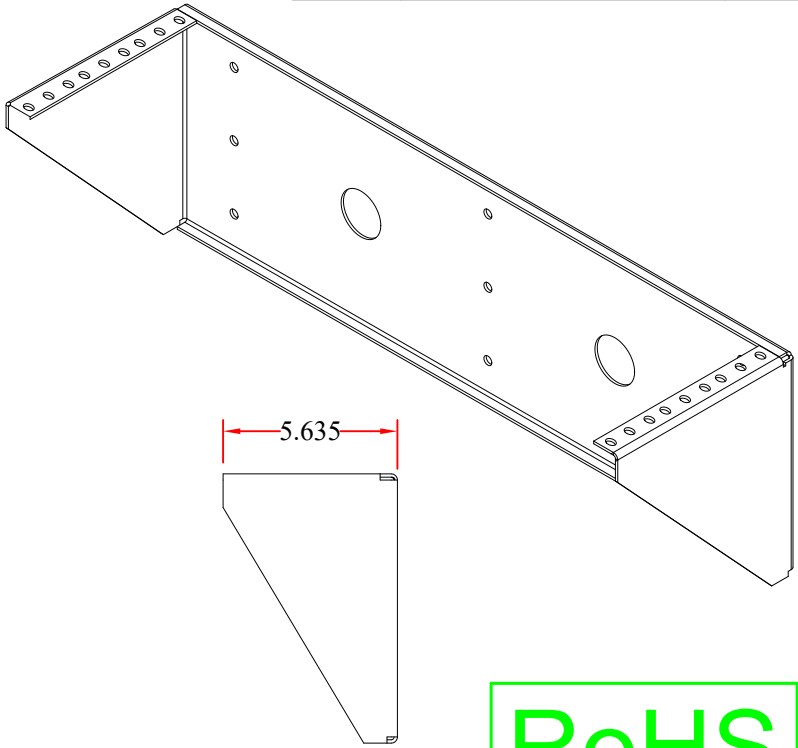

REV.	DESCRIPTION	DATE
A		12-2013
B		02-2016

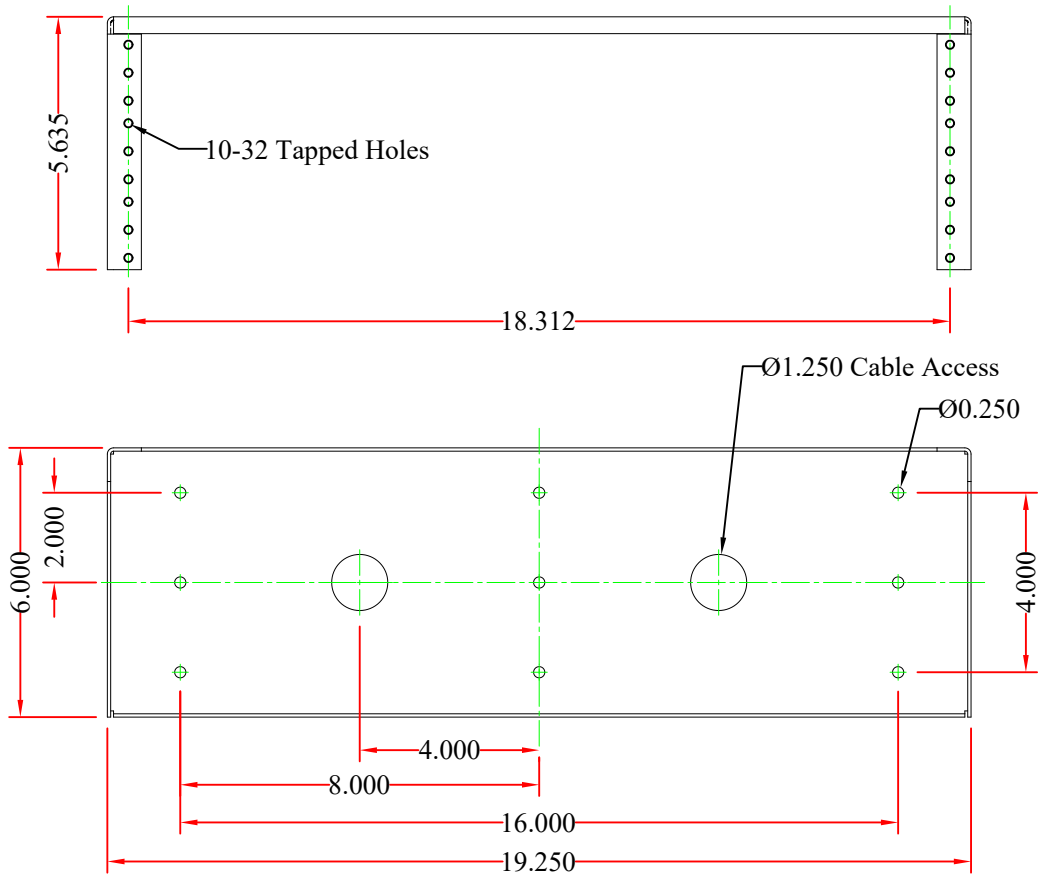

RoHS

NOTE:  
 1. 19" EIA RACK MOUNT COMPLIANT  
 2. RAILS TAKE 10-32 SCREWS  
 3. BLACK POWDER COAT

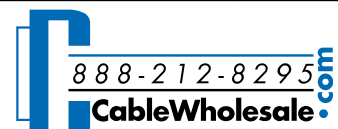
ITEM NUMBER	61R2-24203		DRAWER	JL
TITLE	3U Rackmount, V-Rack Mount		CHECKED	
			APPROVED	
MATERIAL	SCALE		 	
REV.	A	UNIT		INCH
DRAWING NO:				
ID(NO.)	196			