

PARTS LIST DRAWINGS

C-SM150 (1) 150pF capacitor

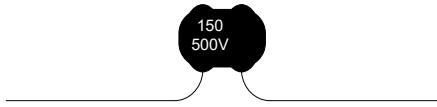

C-SM250 (1) 250pF capacitor

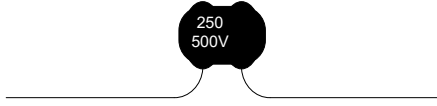

C-TD1-400 (1) 0.1μF capacitor

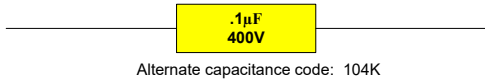

Alternate capacitance code: 104K

C-TD047-400 (2) 0.047μF capacitor



Alternate capacitance code: 473K

C-TD022-400 (1) 0.022μF capacitor



Alternate capacitance code: 223K

C-ET22-50 (2) 22μF polarized capacitor



C-ET47-350 (3) 47μF polarized capacitor

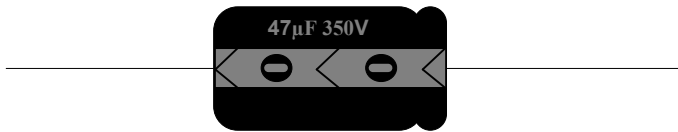

C-ET100-100-IL (1) 100μF polarized capacitor

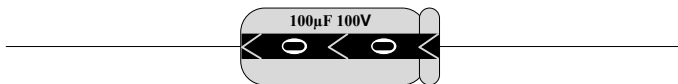

F-ZF010 (1) fuse (1A Fast Blow)



P-K392 (3) knob, black w/ silver top

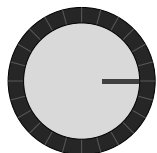

K-P1427N2 (2) handle

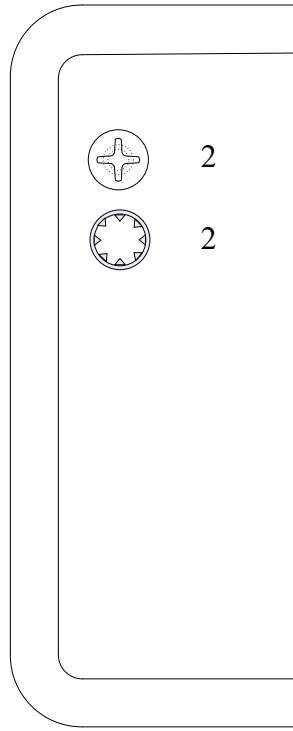

2

#8 screw



2

#8 lock washer

P-ST9-511 (2) 9 pin miniature tube socket

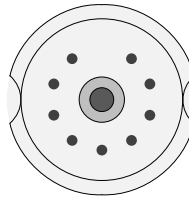

S-H144 (1) Tube Retainer (for EL84)

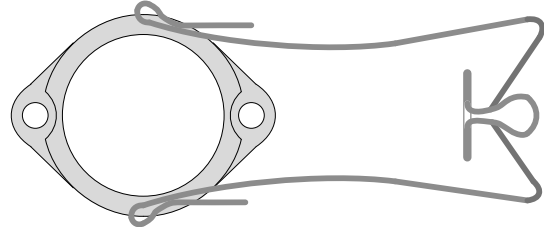

P-SS9-325-BK (1) 9 pin miniature tube shield, black

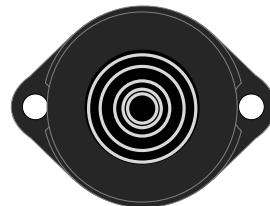

S-H201 (1) fuse holder

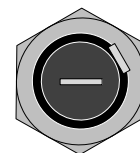
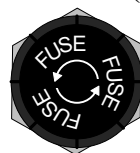

P-H520 (1) power/standby switch

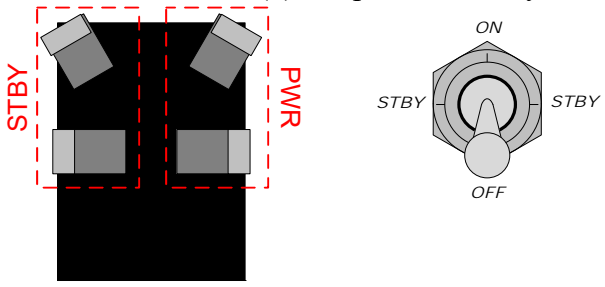

P-T31 (1) output transformer

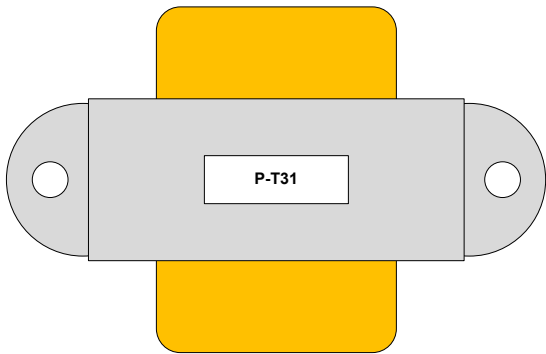

P-T269EX (1) power transformer

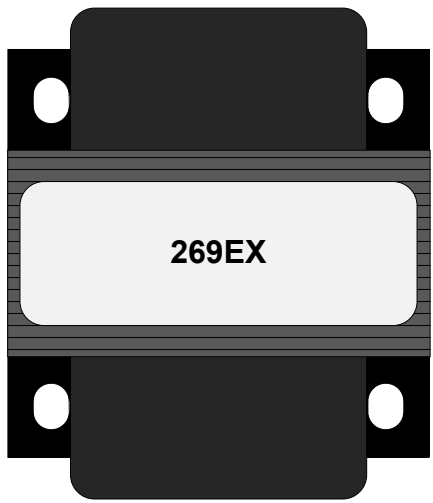

K-P102-CHASSIS (1) steel chassis box & cover

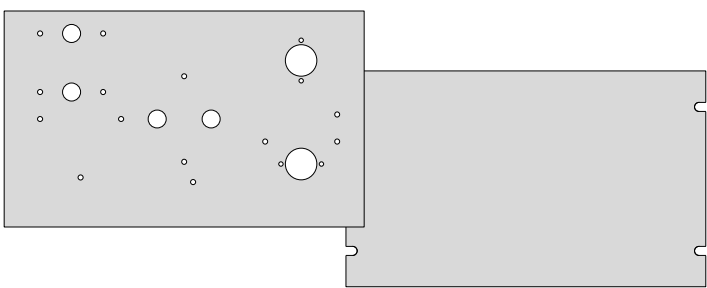

P-L124-P (1) lamp holder

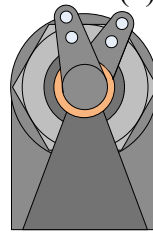

P-L115 (1) red jewel

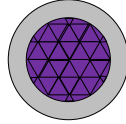

P-47 (1) bulb/lamp (bayonet base)

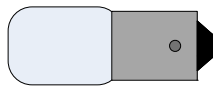

P-G038 (1) rubber grommet, 1/4" center



P-G005 (4) rubber grommet, 3/8" center



P-0501H01 (3) 5 lug terminal strip (1st lug com)

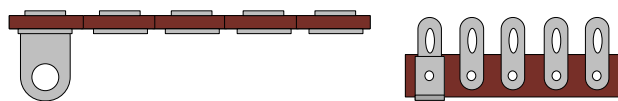

P-0501H (1) 5 lug terminal strip (3rd lug com)

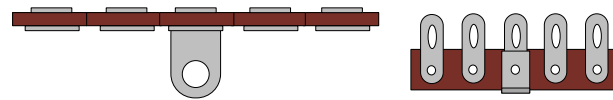

P-0702H (1) 7 lug terminal strip (1st & 7th lug com)

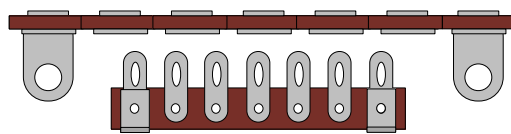

P-0201H (1) 2 lug terminal strip (2nd lug com)



W-SC-11 (1) 1/4" mono jack

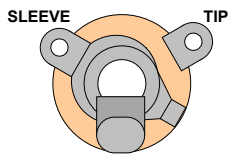

W-SC-12A (1) 1/4" mono jack, switched

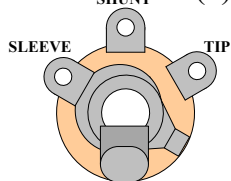

S-HLW38 (5) 3/8" lock washer

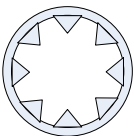

S-HLW6 (6) #6 lock washer



S-HS632-38 (13) #6 screw



S-HHN632 (13) #6 hex nut



S-HS440-14 (4) #4 screw



S-HHN440 (4) #4 hex nut



S-HST8-38 (4) #8 self-tap screws



R-VC1MA-PP (1) 1MΩ push-pull pot (SPST)

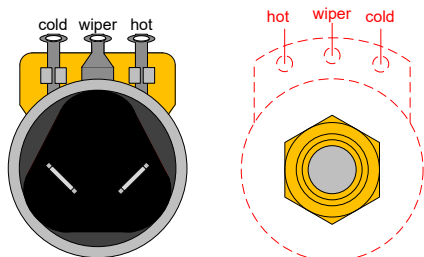

R-VB2-250KAPPSS (2) 250kΩ push-pull pot (DPDT)

Symbol used in the layout drawings to show the switch and potentiometer terminal connections simultaneously.

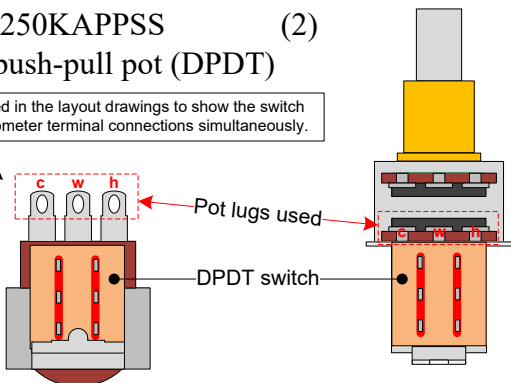

R-B100 (3) 100Ω, 1W resistor

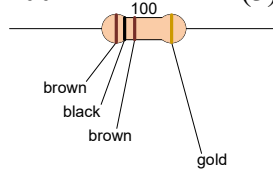

R-Q150 (1) 150Ω, 5W resistor

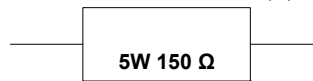

R-B470 (1) 470Ω, 1W resistor

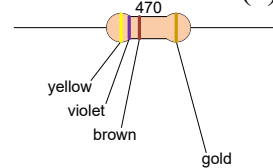

R-A1D5K (2) 1.5kΩ, 1/2W resistor

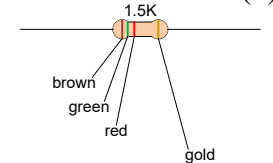

R-A5D6K (1) 5.6kΩ, 1/2W resistor

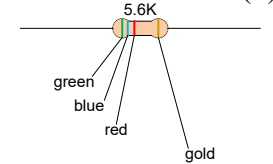

R-A6D8K (1) 6.8kΩ, 1/2W resistor

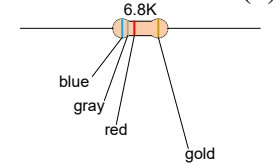

R-A10K (1) 10kΩ, 1/2W resistor

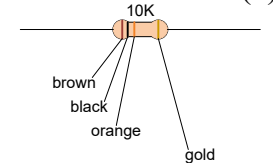

R-B10K (1) 10kΩ, 1W resistor

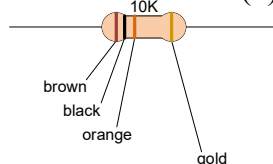

R-A33K (1) 33kΩ, 1/2W resistor

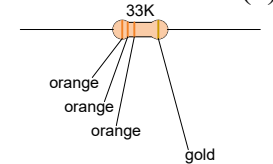

R-A100K (3) 100kΩ, ½W resistor

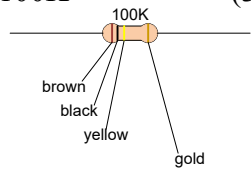

R-A220K (1) 220kΩ, ½W resistor

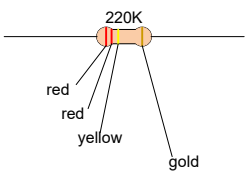

R-B220K (1) 220kΩ, 1W resistor

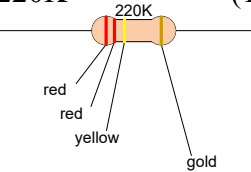

R-A470K (1) 470kΩ, ½W resistor

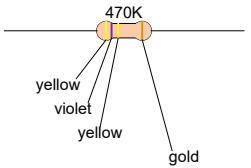

R-A1M (1) 1MΩ, ½W resistor

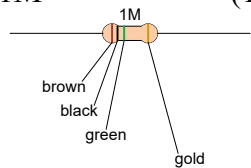

P-Q1N4007 (2) solid state diode



T-EL84-JJ (1) EL84 power tube

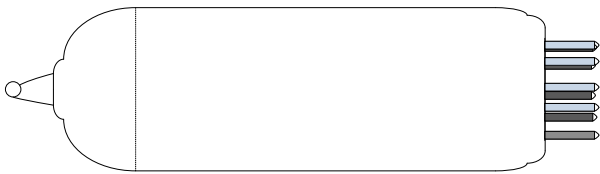

T-ECC803-S-JJ (1) 12AX7/ECC803 preamp tube

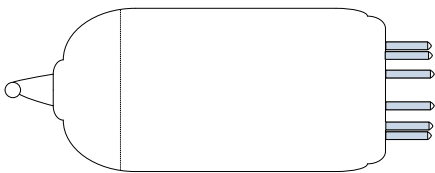

P-H16-150 (4) rubber bumpers, self adhesive

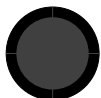

LABELS (1) set of labels

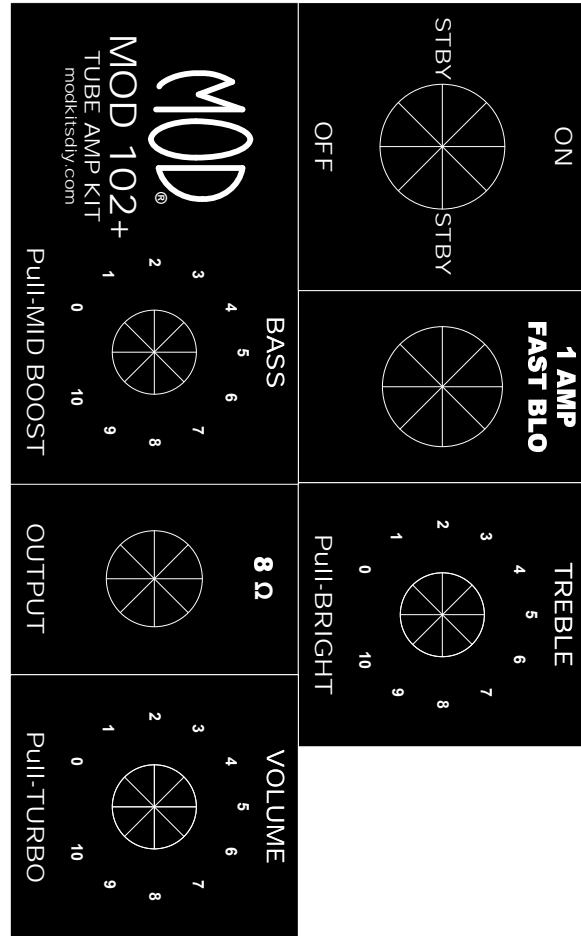

S-W123 (1) power cord



S-W807L	(4 ft)	20 AWG wire (green)
S-W809L	(6 ft)	20 AWG wire (white)
K-P01-0006-BLK	(1 ft)	22 AWG wire (black)