



SENNHEISER



# RS 195

## Digital wireless TV listening system



Instruction manual



## Important safety information

- ▶ Read this instruction manual carefully and completely before using the product.
- ▶ Always include this instruction manual when passing the product on to third parties.
- ▶ Do not use an obviously defective product.

### Preventing damage to health and accidents

- ▶ Protect your hearing from high volume levels. Permanent hearing damage may occur when headphones are used at high volume levels for long periods of time. Sennheiser headphones sound exceptionally good at low and medium volume levels. 
- ▶ Note that these headphones allow you to adjust a higher volume than conventional headphones. This can cause hearing damage in persons with healthy hearing and especially in children.
- ▶ Do not use the product in an environment that requires your special attention (e.g. in traffic or when performing skilled jobs).
- ▶ The product generates stronger permanent magnetic fields that could cause interference with cardiac pacemakers, implanted defibrillators (ICDs) and other implants. Always maintain a distance of at least 3.94"/10 cm between the product component containing the magnet and the cardiac pacemaker, implanted defibrillator, or other implant. 
- ▶ Do not use the product near water. To reduce the risk of fire or electric shock, do not expose the product to rain or moisture.
- ▶ Keep the product, accessories and packaging parts out of reach of children and pets to prevent accidents. Swallowing and choking hazard.
- ▶ Only use the power supply units supplied by Sennheiser.

### Preventing damage to the product and malfunctions

- ▶ Always keep the product dry and do not expose it to extreme temperatures to avoid corrosion or deformation. The normal operating temperature is from 0 to 40 °C/41 to 104 °F.
- ▶ Use the product with care and store it in a clean, dust-free environment.
- ▶ Do not use the product if it is obviously defective, if it has been dropped or if liquids or objects have gotten inside the product. In this case, contact a qualified specialist workshop or your Sennheiser service partner to have the product checked.
- ▶ Switch off the product after use to conserve battery power. When not using the product for extended periods of time, remove the rechargeable batteries.
- ▶ Unplug the power supply unit from the wall socket
  - to completely disconnect the product from the power source,
  - during lightning storms or
  - when not using the product for long periods of time.
- ▶ Always ensure that the power supply unit is
  - in a safe operating condition and easily accessible,

- properly plugged into the wall socket,
  - only operated within the permissible temperature range,
  - not exposed to direct sunlight for longer periods of time in order to prevent heat accumulation.
- ▶ Do not place your headphones on a glass dummy head, chair armrest or similar objects for long periods as this can widen the headband and reduce the contact pressure of the headphones.
  - ▶ Varnish or furniture polish may degrade the feet of the transmitter, which could stain your furniture. You should therefore place the transmitter on a non-slip pad to avoid potential staining of furniture.
  - ▶ Do not operate the product near heat sources.
  - ▶ Clean the product only with a soft, dry cloth.
  - ▶ Use only attachments/accessories/spare parts supplied or recommended by Sennheiser.

#### Intended use/Liability

This wireless headphone system is suitable for use with hi-fi systems, TV sets, and home cinema systems and supports both analog and digital signals simultaneously.

This product is intended for private domestic use only. It is not suitable for commercial use. This product is also not intended to be used with portable audio devices.

It is considered improper use when this product is used for any application not named in this instruction manual and the associated product guides.

Sennheiser does not accept liability for damage arising from abuse or misuse of this product and its attachments/accessories.

Before putting into operation, please observe the respective country-specific regulations.

Safety instructions for standard/rechargeable batteries



**WARNING**

If abused or misused, the standard/rechargeable batteries may leak. In extreme cases, they may even present a risk of

- explosion,
- fire development,
- heat generation,
- smoke or gas development.

	Keep away from children.		Do not heat above 70 °C/ 158 °F, e.g. do not expose to sunlight or throw into a fire.
	Do not expose to moisture.		When not using rechargeable batteries for extended periods of time, charge them regularly (about every three months).
	Do not mutilate or dismantle.		When not using the product for extended periods of time, remove the standard/rechargeable batteries.
	Observe correct polarity.		Only use rechargeable batteries and chargers recommended by Sennheiser.
	Pack/store standard/charged rechargeable batteries so that the terminals cannot contact each other – danger of shorting out/ fire hazard.		Do not continue using defective standard/rechargeable batteries and dispose of them immediately.
	Switch rechargeable battery-powered products off after use.		Immediately remove standard/rechargeable batteries from an obviously defective product.
	Only charge rechargeable batteries at ambient temperatures between 10 to 40 °C/ 50 to 104 °F.		Dispose of batteries/rechargeable batteries at special collection points or return them to your specialist dealer.
	Do not charge standard batteries.		Do not mix standard and rechargeable batteries in the battery compartments.

## The RS 195 digital wireless headphone system

The RS 195 is your personal hearing and ultimate audio companion, providing you with all of the unparalleled sound quality, ease of use and wearing comfort that you expect from a Sennheiser product.

Whether you are watching television or listening to music, the RS 195 ensures that you won't miss a thing: Highly innovative digital wireless technology guarantees crystal clear signal transmission with low latency even while you move from room to room, and the various listening modes allow you to adapt the sound according to your individual needs and preferences. With the RS 195 you'll be able to hear the subtle nuances of dialogs and the slight details of your favorite music like never before.

And although these headphones deliver state-of-the-art performance, their user-friendly design keeps things simple. The convenient controls make it easy to take advantage of the host of features, and the ergonomic design provides a comfortable fit, even after hours of listening.

Sennheiser's RS 195: Personal and adaptable to your listening needs!

### Features

- Closed, circumaural headphones with excellent digital wireless audio transmission
- Exceptional digital audio clarity and transmission range of up to 100 m/328 ft (line of sight)
- Selectable hearing boost presets and an additional noise suppression mode for clearer dialogs and superior speech intelligibility
- The music listening mode reproduces music with an increased dynamic range to preserve the sound image in the best possible way
- Two adjustable levels for the maximum possible volume when using the hearing profiles (from product version 06/2017)
- Supports analog and digital audio inputs and allows toggling between the inputs
- Multi-purpose transmitter – also functions as “easy-charge” cradle and docking station
- Balance control for right/left volume adjustment
- Ergonomic design for enhanced wearing comfort
- 2-year warranty

## Package contents



HDR 195 headphones

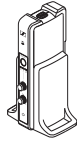

TR 195 transmitter

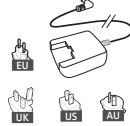

Power supply unit with multi-country adapters  
(EU, UK, US, AU)

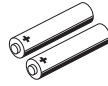

Low self-discharge NiMH rechargeable batteries, AAA size



Optical digital cable, 1.5 m



Stereo audio cable with 3.5 mm jack plugs, 2 m



Quick guide



Safety guide



Brief instruction manual in English, German, French  
The instruction manual in other languages can be  
downloaded as a PDF file at  
[www.sennheiser.com/download](http://www.sennheiser.com/download).

# Product overview

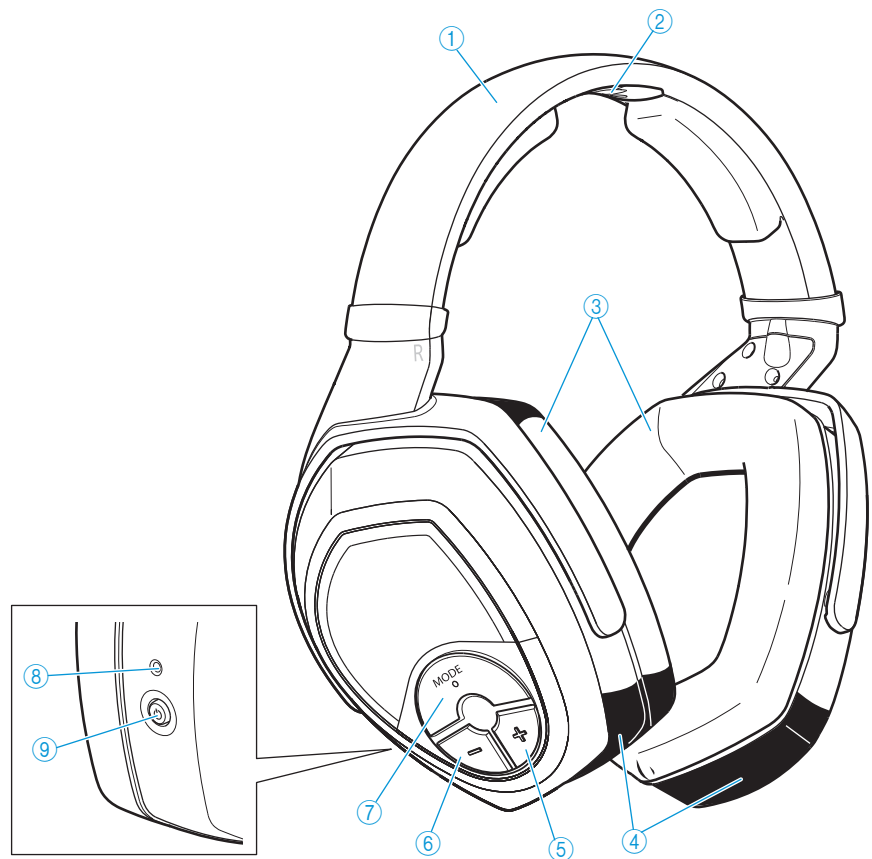

## Overview of the HDR 195 headphones

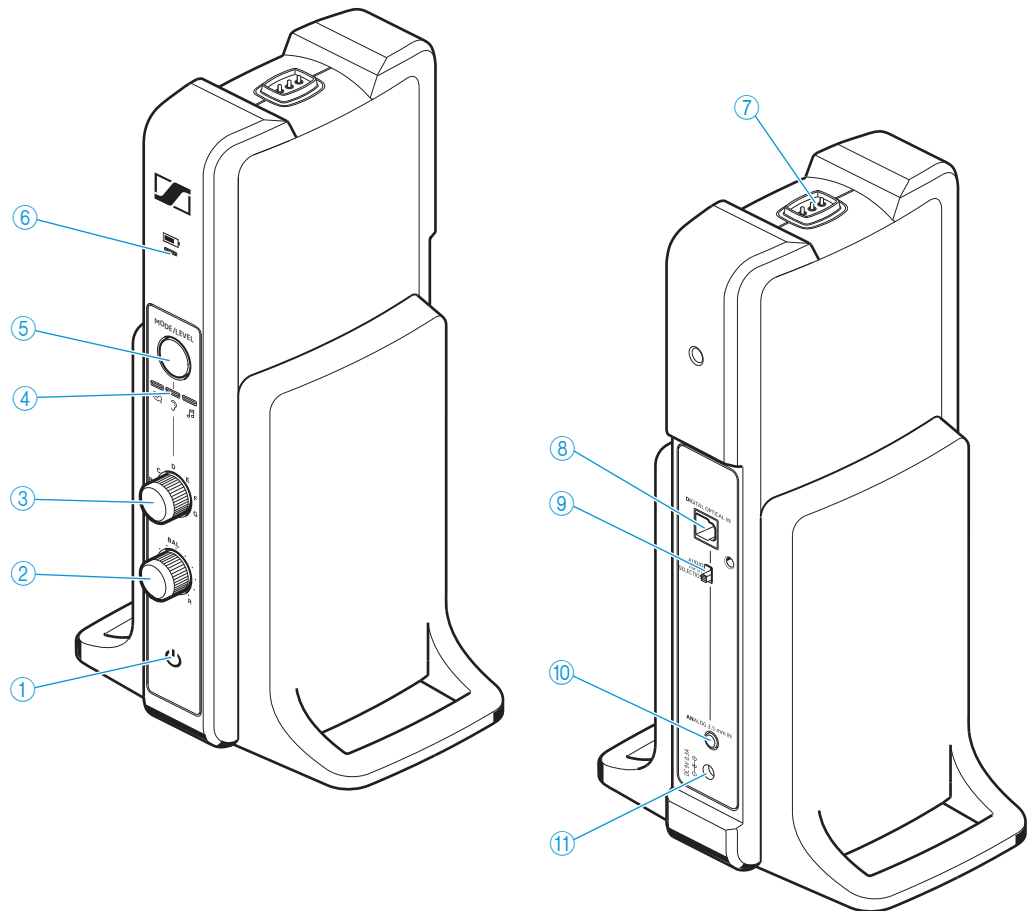

- ① Headband
- ② Charging contacts
- ③ Ear pads
- ④ Ear cups/Battery compartments
- ⑤ Volume + button
- ⑥ Volume – button
- ⑦ **MODE** button  
for *personal hearing* (activating/  
deactivating a hearing profile  
and activating the sound  
optimization options)
- ⑧ HDR status LED
- ⑨ Power HDR button 

## Overview of the TR 195 transmitter



- ① TR status LED 
- ② BAL control  
for adjusting the balance
- ③ A-G rotary switch  
for selecting the hearing profile
- ④ *Personal hearing* LEDs,  
indicating the selected sound  
optimization option
- ⑤ MODE/LEVEL button  
for *personal hearing*  
(activating/deactivating a  
hearing profile, selecting a  
volume level\*, activating the  
sound optimization options)
- ⑥ Charge status LED 
- ⑦ Charging contacts
- ⑧ Digital optical audio input  
**DIGITAL OPTICAL IN**
- ⑨ Audio input switch  
**AUDIO INPUT SELECTION**
- ⑩ Analog audio input  
**ANALOG 3.5 mm IN**  
(3.5 mm jack socket)
- ⑪ DC 9V 0.3A socket  
for the power supply unit

\*from product version 06/2017



## Overview of the LEDs

The LEDs on the headphones and on the transmitter indicate the current operating state. If you are not using the headphones, the LEDs automatically dim after approx. 30 seconds to not disturb you.

### Overview of the LEDs on the headphones

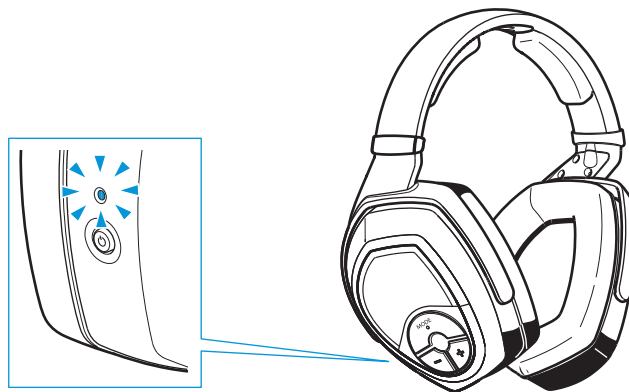

HDR status LED	Meaning
	The headphones are switched off.
	The headphones and the transmitter are connected.
	The headphones and the transmitter are connected and the rechargeable batteries are almost empty.
	The headphones are not connected or cannot connect to the transmitter.
	The headphones are not connected or cannot connect to the transmitter and the rechargeable batteries are almost empty.

Overview of the LEDs on the transmitter

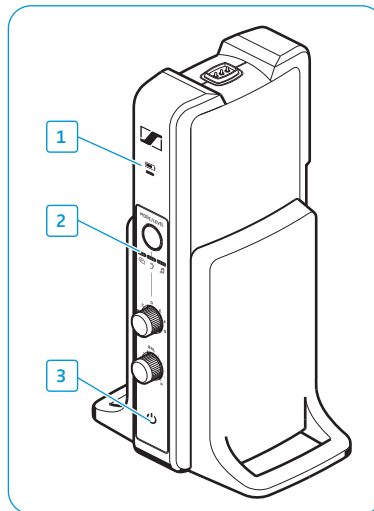

1

Charge status LED	Meaning
	The transmitter is not charging.
	The rechargeable batteries are being charged.
	The rechargeable batteries are fully charged.
	A charging error/battery error has been detected.

When you remove the headphones from the transmitter's headphone holder, the Charge status LED on the transmitter indicates the approximate operating time of the headphones:

Charge status LED	Operating time	Battery capacity
	up to 4 hours	0–25 %
	approx. 4 to 9 hours	25–50 %
	approx. 9 to 14 hours	50–75 %
	approx. 14 to 18 hours	75–100 %

2

Personal hearing LEDs	Hearing profile A-G	Meaning
	deactivated	<p><i>Personal hearing</i> is deactivated and the selected hearing profile is deactivated.</p> <p>The sound from the audio source is reproduced unchanged (<i>normal hearing</i>).</p>

Personal hearing LEDs	Hearing profile A-G	Meaning
	activated	One of the hearing profiles A-G for hearing enhancement is selected.
		In addition to the selected hearing profile, speech intelligibility is improved and annoying background noise is reduced.
		The selected hearing profile reproduces music with an increased dynamic to preserve the sound image in the best possible way.

**i** If you are using *personal hearing*, you can choose between two levels for the maximum possible volume. Information on how to switch between the volume levels can be found on page 26 (from product version 06/2017).

If you connect a second pair of headphones to the transmitter, you cannot make use of the *personal hearing* settings.

Personal hearing LEDs	Meaning
	If all three LEDs flash rapidly 3 times, a second pair of headphones is connected to the transmitter. Switch off the second pair of headphones in order to activate <i>personal hearing</i> .

**3**

TR status LED	Meaning
	The transmitter is connected to the power supply system.
	The transmitter is in standby mode.
	The transmitter and the headphones are connected.
	The transmitter has detected an incompatible digital audio signal (see page 30).

## Putting the RS 195 into operation

### Setting up the transmitter



- ▶ Choose a suitable place near your sound source.
- ▶ Separate the transmitter from other wireless devices in the room by at least 50 cm/20" to avoid interference.
- ▶ Do not place the transmitter close to metal objects such as shelf bars, reinforced concrete walls, etc. as this can decrease the transmitter's range.

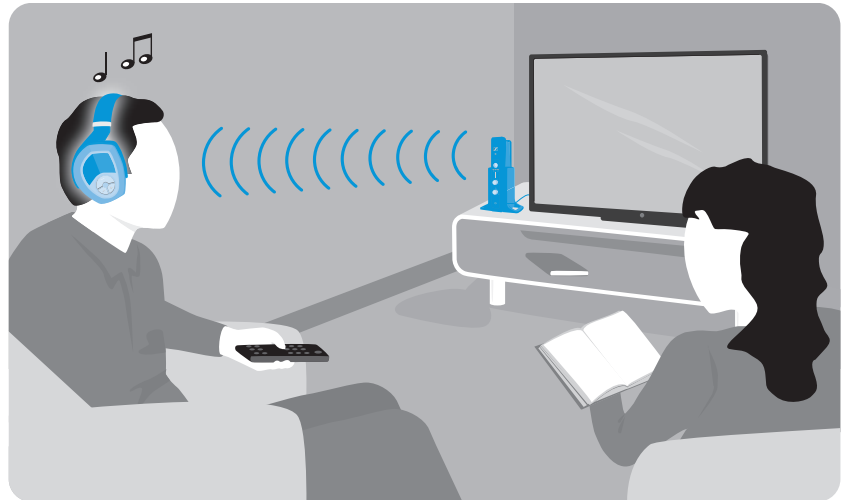

## Connecting the transmitter to audio sources

You can simultaneously connect two audio sources (e.g. a TV and a stereo hi-fi system) to the transmitter. The transmitter features a digital as well as an analog audio input. If you connect two audio sources, you can toggle between them using the **AUDIO INPUT SELECTION** switch (see page 22).

**i** You can also refer to the beginner’s video guides on how to connect your digital wireless headphone system to a TV. The video guides are available at [www.sennheiser.com/how-to-videos](http://www.sennheiser.com/how-to-videos).

- ▶ Switch your audio source off before connecting the transmitter.
- ▶ Check the connection possibilities of your audio source (audio output, usually marked “OUT”).
- ▶ Select the corresponding connection cable and, if necessary, a suitable adapter.
- ▶ Depending on the connection possibility selected, go to the respective chapter and follow the instructions on how to connect the transmitter to an audio source.

Connection possibilities of the audio source		Connection cable	Page
<b>A</b>	Optical (digital)	Optical digital cable	14
<b>B</b>	3.5 mm or 6.3 mm/1/4" jack socket (analog)	Stereo audio cable; in case of a 6.3 mm/1/4" jack socket: with adapter 3.5 mm jack socket to 6.3 mm/1/4" jack plug (to be ordered separately)	15
<b>C</b>	RCA (analog)	Stereo audio cable with adapter 3.5 mm jack socket to 2 RCA plugs (to be ordered separately)	16

**i** Accessories and adapters are available from your Sennheiser partner.

**A**

**Connection possibility A: optical (digital)**

To achieve the best possible listening experience, connect the transmitter to your home cinema or hi-fi system using the supplied optical digital cable.

Your wireless headphone system is able to decode digital audio signals from a device connected to the **DIGITAL OPTICAL IN** input. Note that your RS 195 headphone system only supports digital **PCM** signals. Information on how to set the audio format of the connected audio source to **PCM** can be found in the Sound menu or in the instruction manual of your device.

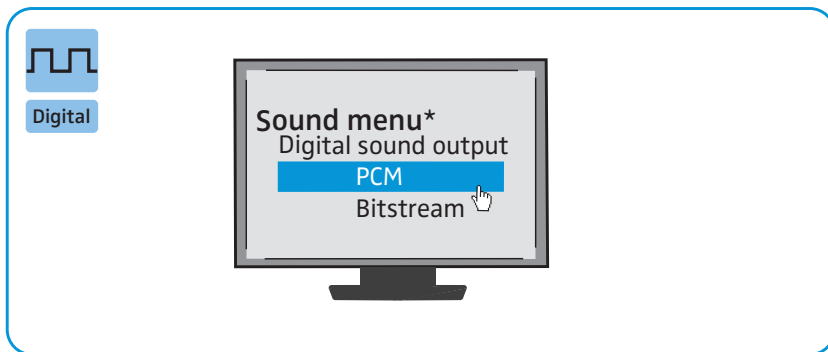

\* The appearance of the Sound menu can vary depending on the device you are using.

- ▶ Pull off the clear protective caps from both plugs before connecting the cable.
- ▶ Connect one end of the optical digital cable to the **DIGITAL OPTICAL IN** input of the transmitter and the other end to the optical output of your audio source.

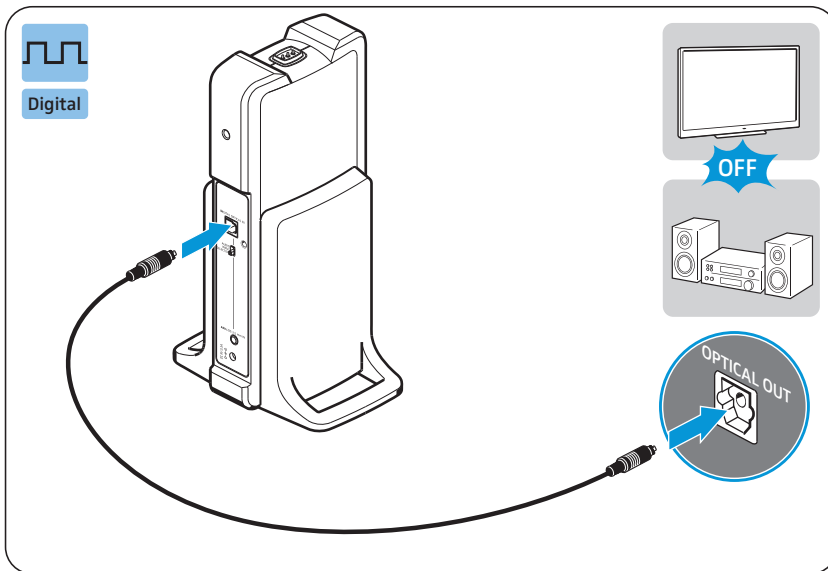
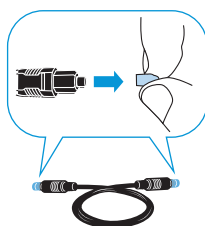

**B** Connection possibility B: 3.5 mm or 6.3 mm/¼" jack socket (analog)

- ▶ If necessary, plug the adapter 6.3 mm/¼" jack plug onto the stereo audio cable.
- ▶ Connect the stereo audio cable to the 3.5 mm jack socket of the transmitter and to the headphone socket of your audio source.

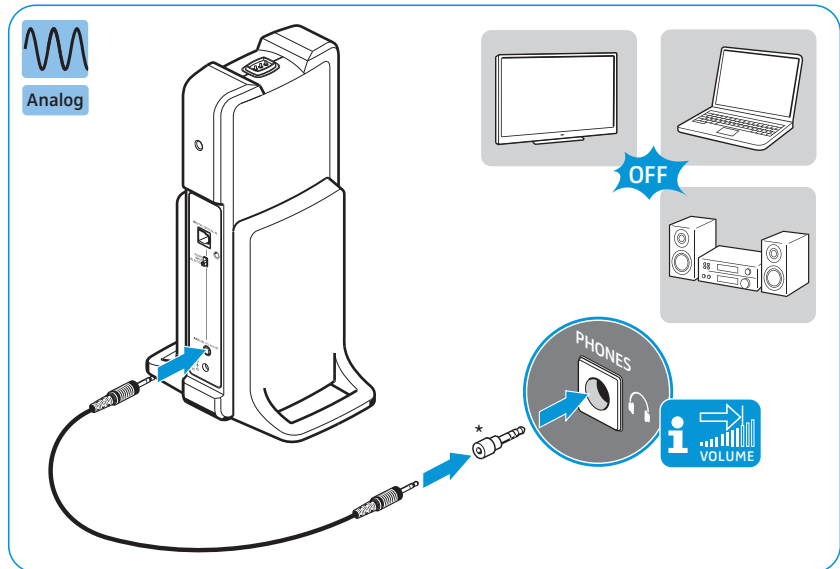

\* optional accessory

**i** Adjust the volume of the headphone socket on your TV/audio source **to at least a medium level.**

This improves the quality of wireless audio transmission. For detailed information, please refer to the instruction manual of your TV/audio source.

If the headphones socket on your audio source is a 6.3 mm/¼" jack socket, you require an adapter (3.5 mm jack plug to 6.3 mm/¼" jack plug, optional accessory) for the supplied 3.5 mm stereo audio cable.

Some TV models mute the loudspeakers when you connect the transmitter to the 3.5 mm headphone socket. Other TV models have their own menu for adjusting the volume of the headphone socket. Check the menu of your TV for information on how to deactivate the muting function or adjust the volume. Alternatively, connect the TV and the transmitter using a different connection possibility (A or C).

C

Connection possibility C: RCA sockets (analog)

- ▶ Plug the RCA adapter onto the stereo audio cable.
- ▶ Connect the stereo audio cable to the 3.5 mm jack socket of the transmitter.
- ▶ Connect the RCA plugs to the RCA outputs of your audio source (usually marked "AUDIO OUT"). Connect the red plug to the red RCA socket and the white plug to the white or black RCA socket.

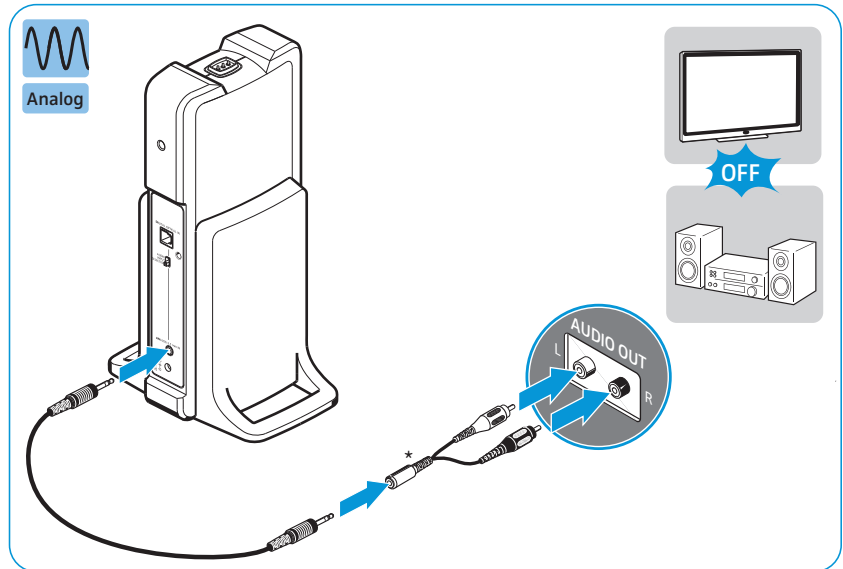

\* optional accessory



## Connecting the transmitter to the power supply system

- 1 Select a suitable country adapter and slide it onto the power supply unit until it clicks audibly into place.
- 2 Connect the connector of the power supply unit to the connection socket of the transmitter.
- 3 Plug the power supply unit into the wall socket.  
The TR status LED  on the transmitter lights up briefly. The transmitter is in standby mode.

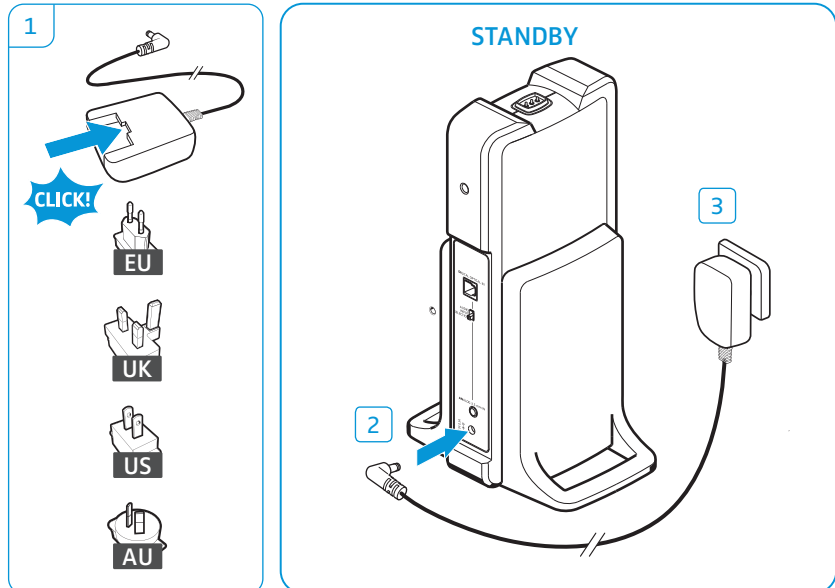

## Inserting or replacing the rechargeable batteries

- 1 Lightly twist the ear pads counterclockwise until you overcome a slight resistance.
- 2 Lift the ear pads off the ear cups to reveal the battery compartments.
- 3 Insert the rechargeable batteries into the compartments. To replace the batteries, pull the batteries out of the compartments and insert the new ones. Observe correct polarity when inserting the batteries. Dispose of old batteries as special waste or return them to your specialist dealer.
- 4 Hook the ear pads onto the ear cups. Observe the **L** (left) and **R** (right) markings on the rear of the ear pads.
- 5 Twist the ear pads clockwise until you hear a click sound.

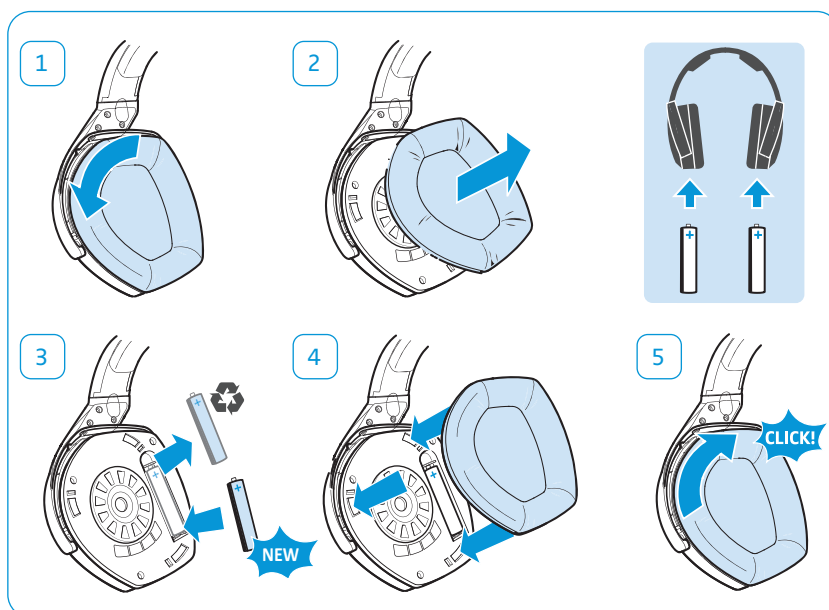

**i** You can also power the headphones using standard batteries (AAA size, 1.5 V). Note however, that standard batteries are not rechargeable, and if you are using standard batteries, do not place the headphones on the transmitter's headphone holder.

## Charging the rechargeable batteries in the headphones

### CAUTION Danger of damage to the headphones!

If you insert non-rechargeable batteries into the battery compartments, the batteries may leak during charging and can damage your headphones.

- ▶ Do not place the headphones on the headphone holder if you are using non-rechargeable batteries.



A complete charging cycle takes about 8.5 hours. However, before using the headphones for the first time, charge the rechargeable batteries for at least 16 hours without interruption to optimize the performance of the batteries.

When the rechargeable batteries are almost empty, the HDR status LED lights up red and you hear beeps in the headphones. The headphones switch off after a few minutes.

- ▶ Place the headphones on the headphone holder of the transmitter. You may place the headphones on either side provided that the charging contacts of the headphones and the transmitter connect. The headphones automatically switch off and the Charge status LED on the transmitter lights up red. When the rechargeable batteries are fully charged, the Charge status LED lights up green.

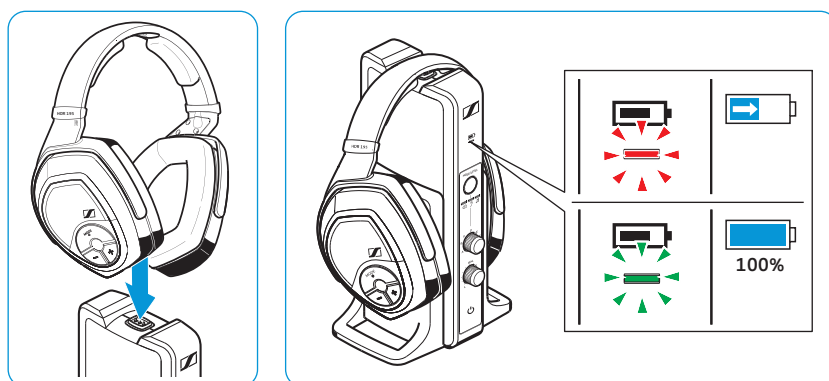

- i** When not in use, place the headphones on the headphone holder to ensure that the rechargeable batteries are fully charged when needed. The intelligent battery charging technology prevents overcharging.

When you remove the headphones from the headphone holder, the Charge status LED on the transmitter indicates the approximate operating time of the headphones (see page 10).

## Adjusting the headband

For good sound quality and best possible wearing comfort, the headband has to be adjusted to properly fit your head. The headphones feature an adjustable headband with a snap-in locking mechanism for easy adjustment.

- ▶ Wear the headphones so that the headband runs over the top of your head. Observe the **L** (left) and **R** (right) markings on the outer headband when putting the headphones on.
- ▶ Adjust the length of the headband so that
  - your ears are comfortably covered by the ear pads,
  - you feel even, gentle pressure around your ears,
  - a snug fit of the headband on the head is ensured.

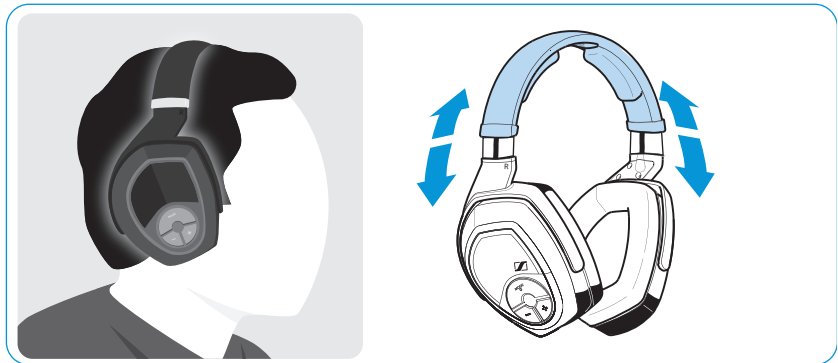

# Using the RS 195

## Switching the wireless headphone system on



### WARNING

#### Danger of hearing damage due to high volumes!

Listening at high volume levels for long periods of time can lead to permanent hearing defects.

- ▶ Before putting the headphones on and before toggling between your audio inputs, adjust the volume on the headphones to a low level. Toggling between the audio inputs may cause enormous volume jumps that can damage your hearing.
- ▶ Do not expose yourself to high volume levels for extended periods of time.



- 1 Switch your audio source on.

If the transmitter is connected to the headphone socket (see page 15) of your audio source, adjust the volume of the headphone socket on your audio source (e.g. TV) to at least a medium level.

- 2 Push the **AUDIO INPUT SELECTION** switch on the transmitter up or down to select your audio source (see page 22).  
The transmitter is in standby mode and the TR status LED  on the transmitter lights up green.

- 3 Remove the headphones from the transmitter's headphone holder (from product version 06/2017).

Or:

Press and hold the Power HDR button  on the headphones for approx. 2 seconds to switch the headphones on.

The transmitter recognizes the paired headphones and automatically transmits a signal. The TR status LED on the transmitter and the HDR status LED on the headphones light up green.

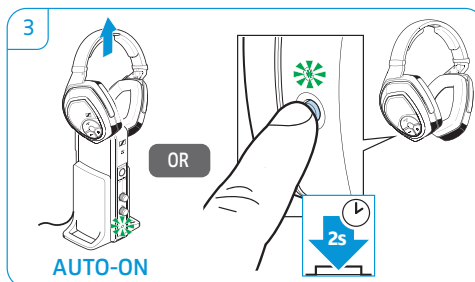
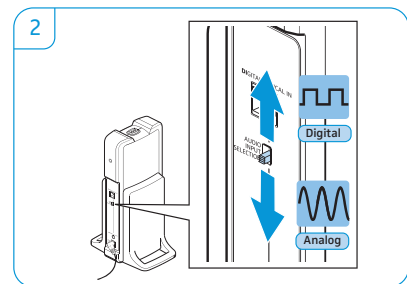
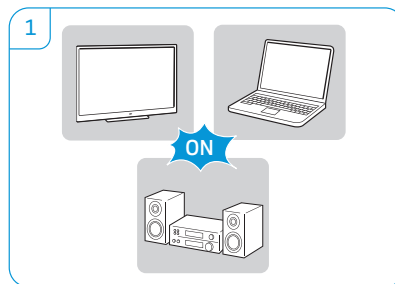

If the headphones are outside the transmission range or if there is no audio signal received from the transmitter for more than 5 minutes, the headphones switch off automatically.

## Selecting an audio input

If both the analog and the digital audio input are connected to an audio source, you can toggle between the two audio inputs.

- ▶ Push the **AUDIO INPUT SELECTION** switch up to select the digital optical audio input (see page 14).
- ▶ Push the **AUDIO INPUT SELECTION** switch down to select the analog audio input (see page 15 and 16).

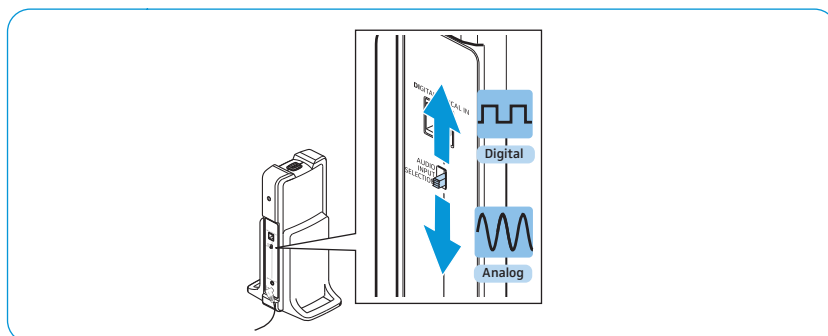

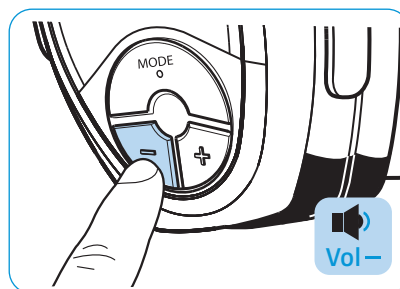
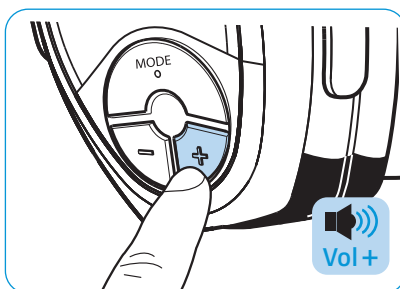

## Adjusting the volume

- ▶ Press the Volume + button or the Volume – button repeatedly until the volume is adjusted to the desired level. When the minimum or maximum volume is reached, you hear a beep in the headphones.



- i** If you are using *personal hearing* and the maximum possible volume is not sufficient, you can further increase the volume level (see page 26, from product version 06/2017).

## Muting/unmuting the headphones

- ▶ Briefly press the Power HDR button  to mute the headphones.
- ▶ Press the Power HDR button  or one of the Volume +/- buttons to cancel the muting.



- i** If the headphones are muted for more than 15 minutes, they switch off automatically.

## Adjusting the balance

The balance control (**BAL**) allows for left/right volume adjustment. Adjust the balance so that you hear equally well with both ears.

- ▶ Turn the **BAL** control on the transmitter to the right **R** or to the left **L** to increase or reduce the volume for your right or left ear.

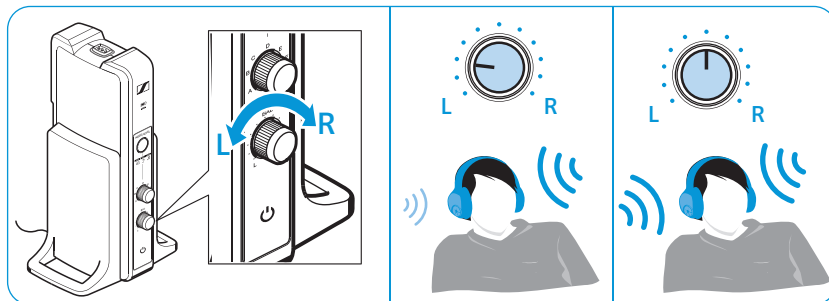

To reset the balance setting:

- ▶ Turn the **BAL** control to the middle position so that its position marker points vertically upwards.

## Activating/deactivating *personal hearing*

You can use your RS 195 in two different ways:

- as a hearing-enhancing headphone system (*personal hearing*)
- as a conventional headphone system (*normal hearing*)

With *personal hearing* activated, you can use the headphone system to enhance your hearing. Different hearing profiles and additional sound optimization options offer you a tailored hearing experience – perfectly matching your personal preferences and hearing ability and allowing you to not only improve speech intelligibility but also to enhance music enjoyment.

*Personal hearing* allows you to choose between two levels for the maximum possible volume (from product version 06/2017).

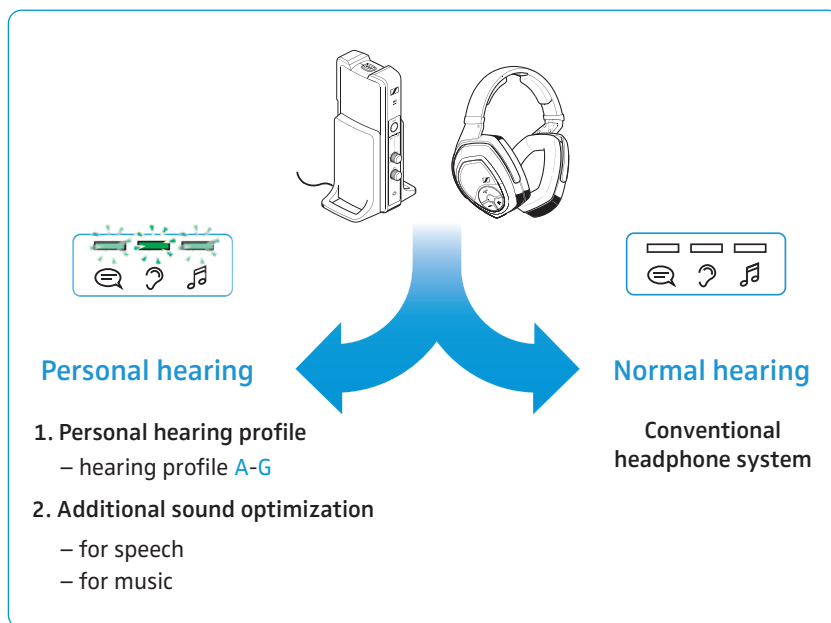

To activate/deactivate *personal hearing*:

- ▶ Press the **MODE/LEVEL** button on the transmitter or the **MODE** button on the headphones for 2 seconds.

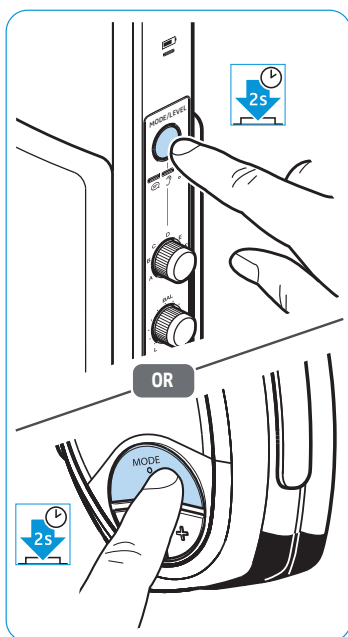

<i>Personal hearing</i>	Display	Explanation
activated		One of the hearing profiles A-G for hearing enhancement is selected (see next chapter). It might also be that one of the LEDs indicating sound optimization for speech or music listening lights up (see page 26).
deactivated		No LED lights up: <i>normal hearing</i> is activated

**i** Additional technical information on the hearing profiles can be found on page 34.



## Personal hearing – Selecting a hearing profile for hearing enhancement

To select the hearing profile that best suits you, proceed as follows:

- 1 Switch your audio source on and select a program where speech is foregrounded. This will facilitate the accurate adjustment of the hearing profile.

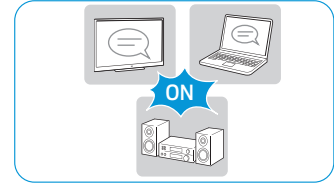

- 2 Use the BAL control to adjust the balance (see page 23). This ensures that each subsequently selected hearing profile is perfectly matched to your left/right balance setting.

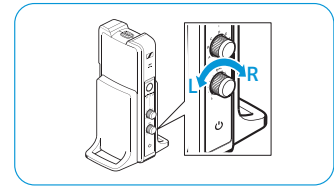

- 3 Press the MODE/LEVEL button on the transmitter for 2 seconds to activate *personal hearing*.

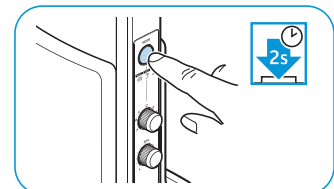

- 4 Press the MODE/LEVEL button on the transmitter repeatedly until only the LED  lights up.

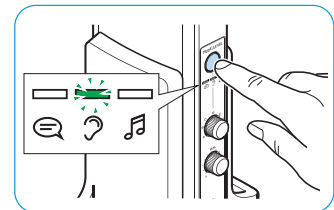

- 5 Use the rotary switch to select a hearing profile A-G and test which of the hearing profiles gives you the best sound quality and helps you to hear best.

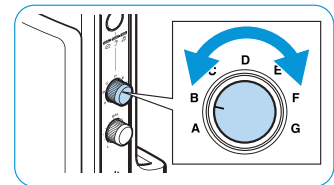

- 6 If the maximum possible volume is not sufficient, press the MODE/LEVEL button on the transmitter for 2 seconds until the LED  flashes 3 times. The volume level "high volume" is activated.\*

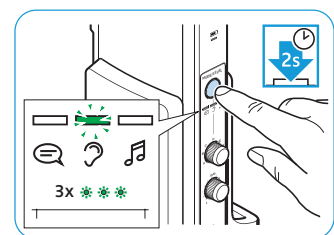

Your personal hearing profile is adjusted.

 We recommend that you repeat the selection of your personal hearing profile from time to time.

 A graphic representation of the hearing profiles and additional technical information can be found on page 34.

\*from product version 06/2017

### Personal hearing – Selecting additional sound optimization options for speech or music listening

Besides the hearing profiles A-G, you can select additional sound optimization options for speech or music listening.

- ▶ Press the **MODE/LEVEL** button on the transmitter or the **MODE** button on the headphones repeatedly until the additional sound optimization option is activated.

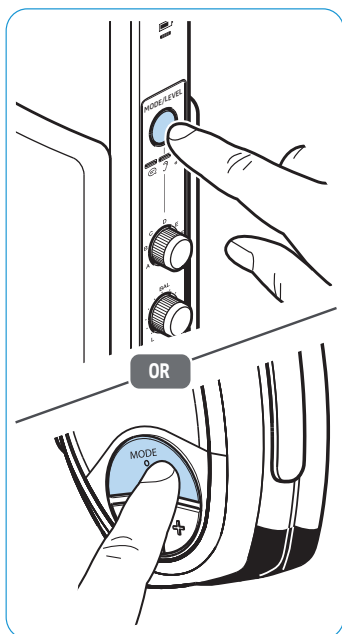

Additional sound optimization	Display	Explanation
none		One of the hearing profiles A-G for hearing enhancement is selected.
for speech reproduction		In addition to the selected hearing profile, speech intelligibility is improved as annoying noise is reduced.
for music reproduction		The dynamic range of the hearing profile is increased to preserve the sound image in the best possible way.

### Personal hearing – Adjusting the maximum possible volume\*

Personal hearing allows you to choose between two levels for the maximum possible volume: “standard” and “high volume”.

The levels for the maximum possible volume can only be adjusted on the transmitter.

- ▶ Press the **MODE/LEVEL** button on the transmitter for 2 seconds until the *Personal hearing* LEDs indicate the desired function.

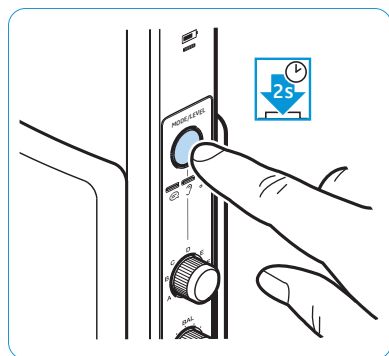

Personal hearing LEDs	Setting
 LED lights up	Standard volume The maximum possible volume is optimally adapted to the hearing profiles A-G. Compared to <i>normal hearing</i> , however, the volume is reduced in order to protect your hearing.
 3x LED flashes 3 times and then lights up	High volume The maximum possible volume is increased if you are using one of the hearing profiles A-G. Only use this setting if the standard setting is not sufficient.
 No LED lights up	<i>Normal hearing</i> is activated, the maximum possible volume is not limited.

**i** It might also be that one of the LEDs indicating sound optimization for speech or music listening lights up (see page 26).

\*from product version 06/2017

## Pairing one or two pairs of headphones to the transmitter

The headphones and the transmitter of your RS 195 headphone system are factory pre-paired. The following procedure is only necessary if you have cleared all pairing settings from your wireless headphone system and want to re-establish the pairing, or if you want to pair another pair of headphones to the transmitter.

You can simultaneously connect up to 2 paired headphones to your TR 195 transmitter. However, if a second pair of HDR 195 headphones is connected to the transmitter, you cannot make use of the hearing profiles in order to improve the listening situation. The hearing profiles can only be used with one pair of HDR 195 headphones.

- ▶ Place the headphones on the headphone holder of the transmitter for one second.  
The Charge status LED  on the transmitter lights up red. The headphones are paired to the transmitter.

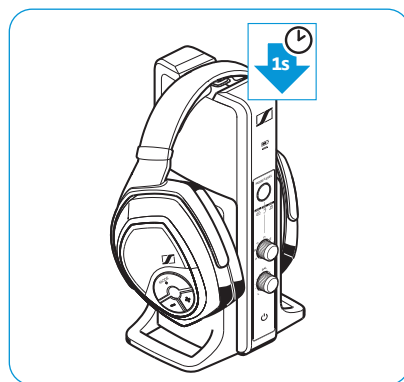

## Switching the wireless headphone system off

There are two ways to switch your wireless headphone system off:

**A**

- ▶ Press and hold the Power HDR button  on the headphones for approx. 2 seconds.

The headphones switch off. If no other pair of headphones is connected to the transmitter, the transmitter switches to standby mode. All LEDs go off.

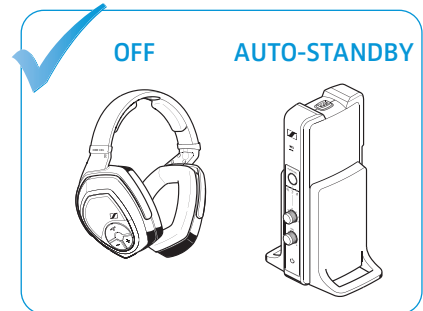
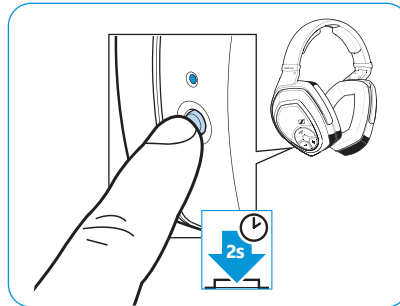

**B**

- ▶ Place the headphones on the headphone holder of the transmitter. The headphones switch off and the charging process starts (see page 19). If no other pair of headphones is connected to the transmitter, the transmitter switches to standby mode.

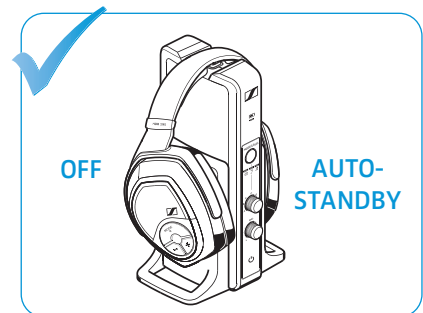
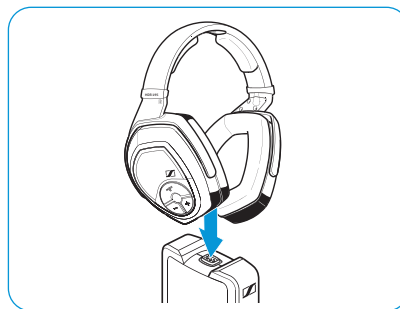

To disconnect the transmitter from the power supply system, unplug the power supply unit from the wall socket.

## Cleaning and maintaining the RS 195

### CAUTION

**Liquids can damage the electronics of the product!**

Liquids entering the housing of the product can cause a short-circuit and damage the electronics.

- ▶ Keep all liquids far away from the product.
- ▶ Do not use any solvents or cleansing agents.

To clean the wireless headphone system:

- ▶ Switch your wireless headphone system off and disconnect the transmitter from the wall socket before cleaning.
- ▶ Clean the product only with a soft, dry cloth.

### Replacing the ear pads

For reasons of hygiene, you should replace your ear pads from time to time. Spare ear pads are available from your Sennheiser partner.

- 1 Lightly twist the ear pads counterclockwise until you overcome a slight resistance.
- 2 Lift the ear pads off the ear cups and dispose of them properly.
- 3 Hook the new ear pads onto the ear cups. Observe the **L** (left) and **R** (right) markings on the rear of the ear pads.
- 4 Twist the ear pads clockwise until you hear a click sound.

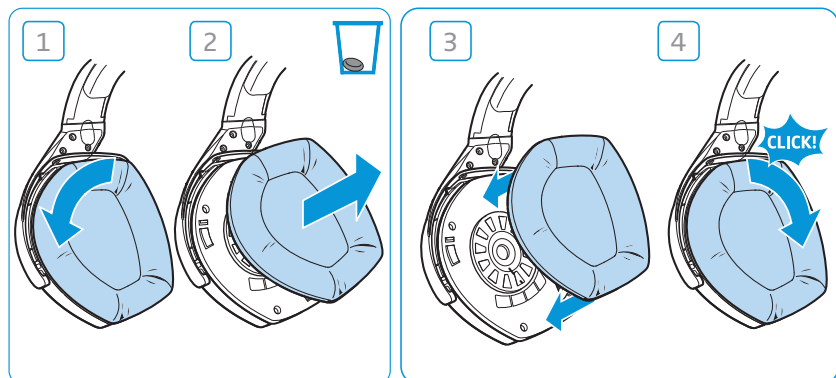

**i** The headband padding can be replaced by the Sennheiser repair service. Please contact your Sennheiser partner.

## If a problem occurs ...

### Sound problems

Problem	Possible cause	Possible solution	Page
No sound	The headphones are switched off.	Switch the headphones on.	21
	No power connection.	Check the connections of the power supply unit.	17
	Headphones are muted.	Deactivate the muting function.	22
	Audio plug is not properly connected.	Check the audio plug connection.	13
	Audio source is switched off.	Switch the audio source on.	–
	Volume of the analog audio source is either set to the minimum or is on mute.	Increase the volume on the audio source to at least a medium level/deactivate the muting function on the audio source.	–
	Audio cable is defective.	Replace the audio cable.	–
	Headphones are not correctly paired with the transmitter (e.g. additional headphones).	Pair the headphones with the transmitter again.	27
	Wrong audio input is selected.	Select the other audio input.	22
	Digital audio connection uses incompatible data transmission settings.	Set the audio format of your audio source to "PCM", with a sampling rate of max. 96 kHz (see the instruction manual of the audio source).	–
Occasional sound dropouts	Headphones are out of the transmitter's range.	Reduce the distance between the headphones and the transmitter.	–
	The signal is shielded.	Remove obstacles between the transmitter and the headphones.	–
	There are interfering devices (e.g. WLAN routers, Bluetooth devices or microwaves) in the vicinity.	Change the position of the transmitter or of the headphones.	12
		Ensure that the transmitter is separated from other wireless devices by at least 50 cm/20".	–
Sound too low	Headphone volume is adjusted too low.	Increase the volume on the headphones.	22
	You are using <i>personal hearing</i> and the "standard" setting for the maximum possible volume is activated.	Activate the "high volume" setting in order to be able to increase the maximum possible volume (from product version 06/2017).	26
	The volume of the analog audio source is adjusted too low.	Increase the volume of the analog audio source to at least a medium level.	–
You hear echoes when using the headphones with a TV	Some TVs can adjust a delay or latency of the audio signal for the digital audio output.	Check the audio output settings of your TV and set the latency to "0".	–
Sound only on one ear	The balance is misadjusted.	Adjust the balance.	23
	The audio cable is not properly connected.	Check the audio plug connection.	13
	The audio cable is defective.	Replace the audio cable.	–

Problem	Possible cause	Possible solution	Page
Sound is distorted	The signal of the audio source is distorted.	Reduce the volume of the audio source.	–
	The volume on the headphones is adjusted too high.	Reduce the volume on the headphones.	22
	The volume of the analog audio source is adjusted too high.	Reduce the volume of the analog audio source to a medium level.	–
Hearing profile cannot be activated. <i>Personal hearing</i> LEDs are flashing	Two pairs of headphones are connected to the transmitter.	Switch off the second pair of headphones. The hearing profiles can only be used with one pair of HDR 195 headphones.	–

## Other problems

Problem	Possible cause	Possible solution	Page
Transmitter does not switch on	No power connection.	Check the connections of the power supply unit.	17
Headphones do not switch on	The rechargeable batteries are empty.	Recharge the rechargeable battery.	19
	No batteries inside the battery compartments.	Insert the rechargeable batteries.	18
	The rechargeable batteries are inserted the wrong way round.	Remove the rechargeable batteries from the headphones and reinsert them again. Observe correct polarity.	18
Operating time decreases	The rechargeable batteries are exhausted.	Replace the rechargeable batteries with new ones.	18
Hearing profile cannot be activated	A second pair of headphones is connected to the transmitter (when pressing the MODE button, the <i>Personal hearing</i> LEDs flash 3 times).	Switch off all other connected headphones.	28
You hear beeps in the headphones	The rechargeable batteries are almost empty.	Recharge the rechargeable battery.	19
Headphones cannot be connected to the transmitter	Distance to the transmitter is too large.	Reduce the distance to the transmitter.	–
	Headphones are not paired with the transmitter.	Pair the headphones with the transmitter.	27
	One pair of headphones is being charged so that you cannot pair a second pair of headphones.	Perform a proximity pairing: 1. Place the headphones as close as possible to the transmitter. 2. Switch the headphones on. 3. Press the Volume +/- buttons simultaneously for about 7 seconds.	–
	Headphones are not compatible.	Only use Sennheiser HDR 165, 175, 185, or 195 wireless headphones.	–

If a problem occurs that is not listed in the above table or if the problem cannot be solved with the proposed solutions, visit the RS 195 product page at [www.sennheiser.com](http://www.sennheiser.com) for the most up-to-date list of frequently asked questions.

You may also contact your local Sennheiser partner for assistance. To find a Sennheiser partner in your country, search at [www.sennheiser.com](http://www.sennheiser.com).

## Leaving the range of the transmitter

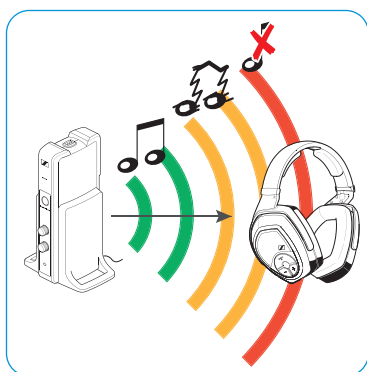

The range of the transmitter largely depends on environmental conditions such as wall thickness, wall composition etc. If the headphones leave the range of the transmitter, the audio first cuts out occasionally until it finally cuts out completely.

If you re-enter the transmission range within 5 minutes, the connection is automatically re-established.

If you spend more than 5 minutes outside the transmission range, the headphones switch off automatically.

## Clearing the pairing settings from the headphones

- 1 Press the Volume +/- buttons simultaneously and hold for 2 seconds. The HDR status LED blinks red rapidly.
- 2 Press the HDR power button  while holding the Volume +/- buttons pressed. Release all 3 buttons. The HDR status LED lights up green or red, depending on the battery condition, and starts blinking slowly. The pairing settings are cleared from the headphones.

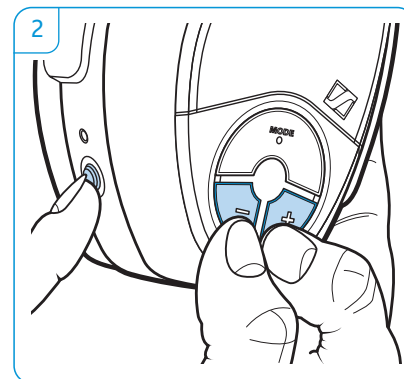
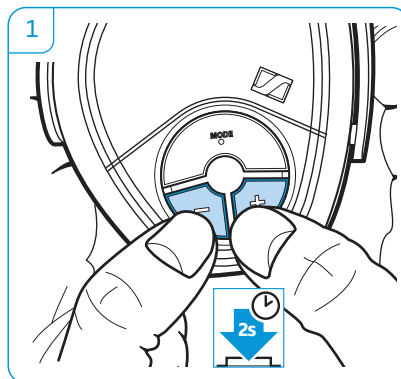



# Specifications

## RS 195 system

Carrier frequency	2.40 to 2.48 GHz
Modulation	8-FSK Digital
Signal-to-noise ratio	analog input: typ. 85 dBA at 1 V <sub>rms</sub> digital input: > 90 dBA
RF output power	max. 10 dBm Class 1
Range	up to 100 m (line of sight)
Max. number of simultaneously connected headphones	2 (with <i>personal hearing</i> deactivated)
Temperature range	operation: 0 °C to +40 °C/32 °F to +104 °F storage: -25 °C to +70 °C/-13 °F to +158 °F
Relative humidity	operation: 10 to 80 %, non condensing storage: 10 to 90 %

## HDR 195 headphones

Type	circumaural, closed
Transducer principle	dynamic, neodymium magnets
Frequency response	17 Hz to 22 kHz
Max. SPL	max. 117 dB at 1 kHz, 3 % THD
THD	< 0.5 % at 1 kHz, 100 dB SPL
Operating time	up to 18 hours
Charging time of rechargeable batteries	up to 8.5 hours
Power supply	2 AAA size low self-discharge NiMH rechargeable batteries, 1.2 V, 820 mAh
Magnetic field strength	2.7 mT
Weight (incl. batteries)	approx. 340 g
Dimensions (W x H x D)	approx. 17 cm x 20 cm x 9.5 cm

## TR 195 transmitter

Connections	digital input: optical analog input: 3.5 mm jack socket
Power supply	9 V $\text{---}$ , 300 mA
Power consumption	operation: typ. 4 W standby: $\leq$ 0.3 W (without charging)
Dimensions (W x H x D)	approx. 12.7 cm x 23.4 cm x 10.9 cm

## Sennheiser NT 9-3AW power supply unit

Nominal input voltage/current	100–240 V~/100 mA
Power frequency	50–60 Hz
Nominal output voltage	9 V $\text{---}$
Nominal output current	300 mA
Temperature range	operation: 0 °C to +40 °C/32 °F to +104 °F storage: -40 °C to +85 °C/-40 °F to +185 °F
Relative humidity	operation: 0 to 90 %, non condensing storage: 0 to 90 %

# Additional technical information

## Hearing profiles A-G

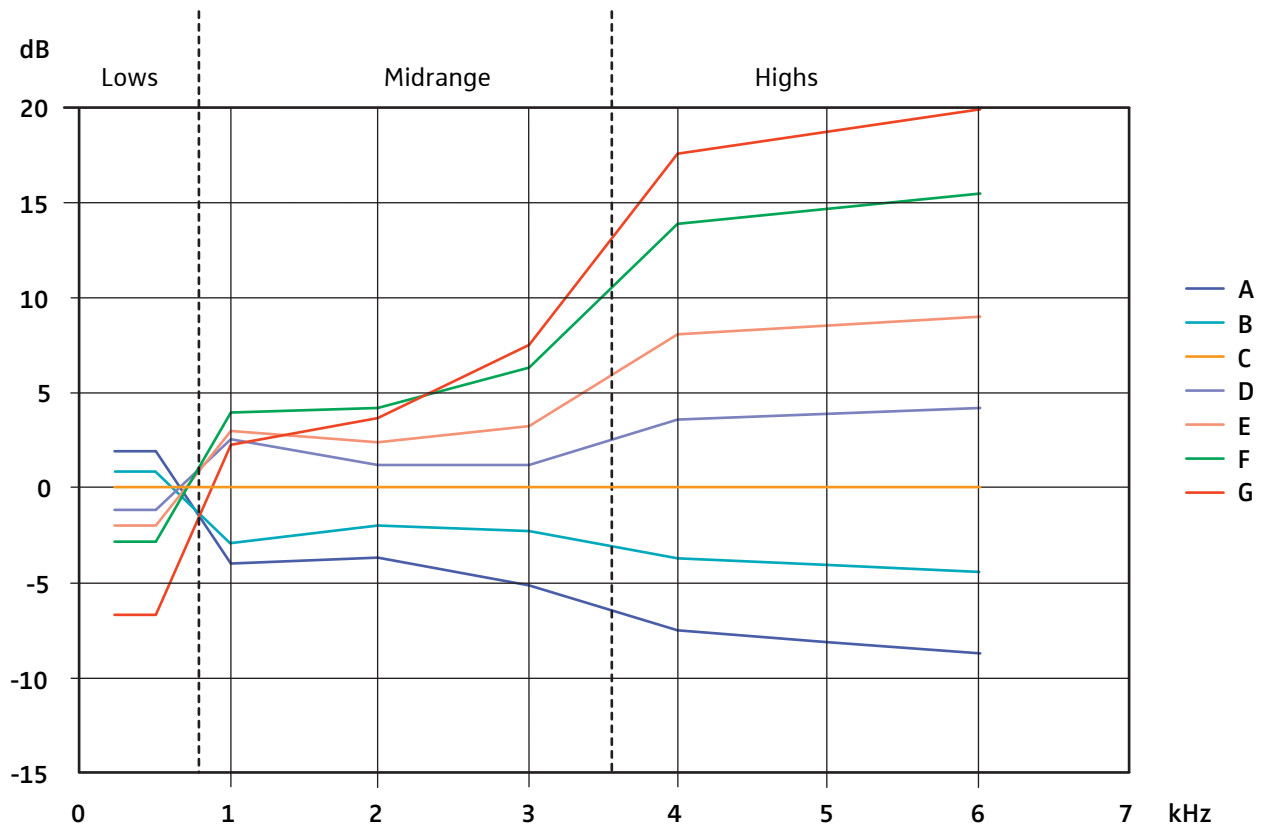

## Technical parameters of the hearing profiles A-G

Display	Additional sound optimization	Compression <sup>1</sup>	Dynamic range <sup>2</sup>	Noise suppression <sup>3</sup>	Max. SPL Standard/High volume setting <sup>4</sup>
	–	–	as audio source	–	110 dB
	–	yes	strongly reduced	–	85 dB/100 dB
	Speech	yes	strongly reduced	activated	85 dB/100 dB
	Music	yes	slightly reduced	–	90 dB/105 dB

### <sup>1</sup> Compression

All hearing profiles feature a compression function which compensates for volume differences by boosting the volume of quiet passages and reducing the volume of loud passages if necessary.

Compression seems to put the speech in the foreground, making it easier to understand.

## <sup>2</sup> Dynamic range

Dynamic range is the ratio between the loudest and the quietest parts of an audio signal. These two values limit the complete dynamic range.

If the dynamic range is reduced, the sound pressure levels of the loudest and the quietest sounds are close to one another. Volume differences between loud and quiet sounds are therefore less audible.

If the dynamic range is increased, volume differences can be heard more clearly. The sound image of music is therefore perceived as especially rich since high and low frequencies are easier to be distinguished at higher volumes.

## <sup>3</sup> Noise suppression

When speech is mixed with annoying background noise, speech may be difficult to understand.

The speech intelligibility function automatically detects and reduces annoying background noise. The audio signal is permanently analyzed and adjusted accordingly so speech is foregrounded and easier to understand.

## <sup>4</sup> Max. SPL

measured with white noise

The volume level "high volume" is only available from product version 06/2017.

# Manufacturer declarations

## Warranty

Sennheiser electronic GmbH & Co. KG gives a warranty of 24 months on this product.

For the current warranty conditions, please visit our website at [www.sennheiser.com](http://www.sennheiser.com) or contact your Sennheiser partner.

### FOR AUSTRALIA ONLY

Sennheiser goods come with guarantees that cannot be excluded under the Australian Consumer Law. You are entitled to a replacement or refund for a major failure and compensation for any other reasonably foreseeable loss or damage. You are also entitled to have the goods repaired or replaced if the goods fail to be of acceptable quality and the failure does not amount to a major failure.

This warranty is in addition to other rights or remedies under law. Nothing in this warranty excludes, limits or modifies any liability of Sennheiser which is imposed by law, or limits or modifies any remedy available to the consumer which is granted by law.

To make a claim under this warranty, contact: Sennheiser Technical Services and Spare Parts Sales, c/o Linfox, Gate 3, 1 Fox Lane, Erskine Park, 2759, NSW Australia, phone: +61 2 9910 6700  
email: [au-service@sennheiser.com](mailto:au-service@sennheiser.com)

All expenses of claiming the warranty will be borne by the person making the claim.

The Sennheiser International Warranty is provided by Sennheiser Australia Pty Ltd (ABN 68 165 388 312), The Zenith, Tower A, L14, 821 Pacific Highway Chatswood NSW 2067, Australia.

## In compliance with the following requirements

### EU declaration of conformity



- ErP Directive (2009/125/EC)
- RoHS Directive (2011/65/EU)

Hereby, Sennheiser electronic GmbH & Co. KG declares that the radio equipment type RS 195 (TR 195, HDR 195) is in compliance with the Radio Equipment Directive 2014/53/EU.

The full text of the EU declaration of conformity is available at the following internet address: [www.sennheiser.com/download](http://www.sennheiser.com/download).

### Notes on disposal

- WEEE Directive (2012/19/EU)
- Battery Directive (2006/66/EC & 2013/56/EU)



The symbol of the crossed-out wheeled bin on the product, the battery/rechargeable battery (if applicable) and/or the packaging indicates that these products must not be disposed of with normal household waste, but must be disposed of separately at the end of their operational lifetime. For packaging disposal, please observe the legal regulations on waste segregation applicable in your country.

Further information on the recycling of these products can be obtained from your municipal administration, from the municipal collection points, or from your Sennheiser partner.

The separate collection of waste electrical and electronic equipment, batteries/rechargeable batteries (if applicable) and packagings is used to promote the reuse and recycling and to prevent negative effects caused by

e.g. potentially hazardous substances contained in these products. Here-with you make an important contribution to the protection of the environment and public health.

Statements regarding FCC and Industry Canada

<b>FCC Supplier's Declaration of Conformity (SDoC)</b>	
We,	 <b>SENNHEISER</b> Model No: TR 195, HDR 195
	Sennheiser electronic Corporation One Enterprise Drive • Old Lyme • CT 06371 • USA Tel: +1 (860) 434 9190 Fax: +1 (860) 434 1759
declare the above device comply with the requirements of Federal Communications Commission.	
This device complies with Part 15 of the FCC rules. Operation is subjected to the following two conditions: 1) This device may not cause harmful interference, and 2) This device must accept any interference received, including interference that may cause undesired operation.	
Responsible Party: Michael Lieske	

This device complies with Part 15 of the FCC rules and RSS-210 of Industry Canada. Operation is subject to the following two conditions: 1) This device may not cause harmful interference, and 2) This device must accept any interference received, including interference that may cause undesired operation.

This equipment has been tested and found to comply with the limits for a Class B digital device, pursuant to part 15 of the FCC rules and RSS-210 of Industry Canada. These limits are designed to provide reasonable protection against harmful interference in a residential installation. This equipment generates, uses and can radiate radio frequency energy and, if not installed and used in accordance with the instructions, may cause harmful interference to radio communications. However, there is no guarantee that interference will not occur in a particular installation. If this equipment does cause harmful interference to radio or television reception, which can be determined by turning the equipment off and on, the user is encouraged to try to correct the interference by one or more of the following measures:

- Reorient or relocate the receiving antenna.
- Increase the separation between the equipment and receiver.
- Connect the equipment into an outlet on a circuit different from that to which the receiver is connected.
- Consult the dealer or an experienced radio/TV technician for help.

Changes or modifications made to this equipment not expressly approved by Sennheiser electronic Corp. may void FCC authorization to operate this equipment.

CAN ICES-3(B)/NMB-3(B)

### RF Radiation Exposure Information

Since the radiated output power of this device is far below the FCC / IC radio frequency exposure limits, it is not subjected to routine RF exposure evaluation as per Section 2.1093 of the FCC rules and RSS-102 of Industry Canada.

This device meets FCC/ IC RF exposure guidelines for an uncontrolled environment. The transmitter of this device should be installed and operated at least 20 cm away from the user's body. Use of other accessories not verified by the manufacturer may not ensure compliance with FCC / IC RF exposure guidelines.

This transmitter must not be co-located or operated in conjunction with any other antenna or transmitter.

### Trademarks

Sennheiser is a registered trademark of Sennheiser electronic GmbH & Co. KG.

Other product and company names mentioned in this instruction manual may be the trademarks or registered trademarks of their respective holders.



**Sennheiser electronic GmbH & Co. KG**  
Am Labor 1, 30900 Wedemark, Germany  
[www.sennheiser.com](http://www.sennheiser.com)

Publ. 09/19, A06