

FLG4 GRAVITY FEED GUNS



HVLP Solvent-based Value Kit Includes:

- 1.3mm, 1.5mm & 1.8mm fluid tips
- 900cc aluminum cup, air adjusting valve with gauge

HVLP Waterborne Value Kit Includes:

- 1.3mm, 1.5mm & 1.8mm fluid tips
- 20 oz. Acetal cup, air adjusting valve with gauge

HVLP Gun Value Kit Includes:

- 1.8mm & 2.2mm fluid tips
- 900cc aluminum cup

Waterborne compatible when using a plastic or disposable cup system.



Order No.	Model No.	Fluid Tip	Air Cap	Cup	Application
803558	FLG-670	1.3, 1.5, 1.8	HVLP #3	900cc Aluminum	Top coats, light primers
803559	FLG-671	1.3, 1.5, 1.8	HVLP #3	20 oz. Acetal	Waterborne top coats, light primers, primers
803560	FLG-678	1.8, 2.2	HVLP #3	900cc Aluminum	Primers, liquid masking, chip guards, other specialty materials

FinishLine® Gravity Feed Air Caps

#3 air cap (HVLP)	Primers, basecoats, clearcoats, single stage and low VOC Air Cap Order No. 690001 Air Cap Model No. FLG-1-3 13 CFM @ 23 PSI inlet	Air Cap Pattern 10½"
Fluid Tips	1.3mm, 1.5mm, 1.8mm, 2.2mm	



Refer to Service Bulletin: SB-2-775

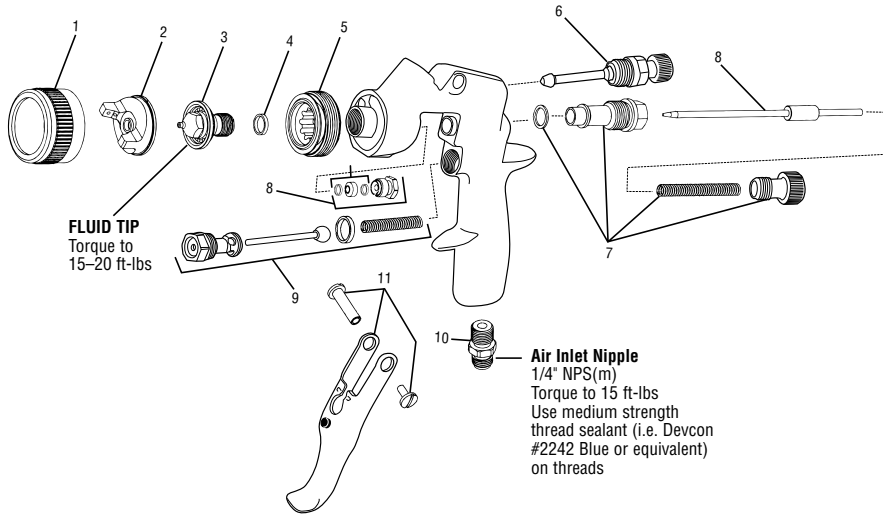

Ref. No.	Order No.	Model No.	Description	Ind. Parts Req.
1	690017	FLG-333	Retaining Ring	1
2	See Air Caps chart, above		Air Cap	1
3	See Chart 1		Fluid Tip & Seal Kit	1
4	690020	FLG-304-K5	Fluid Tip Seal (Kit of 5)	1
5	690021	FLG-305	Baffle	1
6	803528	FLG-465	Spreader Air Adjustment Valve	1
7	803525	FLG4-364-K	Needle Knob, Spring, Bushing & Gasket Kit	1
8	803526	FLG4-366-K	FLG4 Needle, Needle Packing & Nut Kit	1
9	190780	JGS-449-1	Air Valve & Gasket Kit	1
10	190287	P-MB-51	Air Inlet Nipple	1
11	191943	JGS-477-1	Trigger, Trigger Stud & Screw	1
12	192151	KGP-13-K5	Cup Gasket Kit (Kit of 5)	1
13	702576	702576	Metal Gravity Feed Cup	1
	190252	GFC-501	Acetal Gravity Feed Cup	1
14	190944	GFC-404-K2	Disposable Lid Kit (Kit of 2)	1
15	190181	KGP-5-K5	Filter Kit (Kit of 5)	1
	803527	FLG4-488-K	FLG4 Gun Repair Kit (Contains 1 each: Fluid Tip Seal, Needle Packing, Trigger Stud, Trigger Screw, and Gasket for Air Valve & Needle Bushing.)	1
	519210	FLG-463	Air Cap #3 HVLP Test Cap	1

CHART 1

Fluid Tip Order No.	Part No.	Tip Size (mm)	Application
803051	FLG-332-13K	1.3	Stains, lacquers, basecoats, clears
803052	FLG-332-15K	1.5	General purpose, light to medium viscosity materials
803053	FLG-332-18K	1.8	Primers, medium viscosity materials
803054	FLG-332-12K	2.2	Heavy materials

Cup Drawing

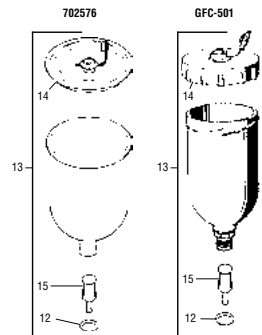
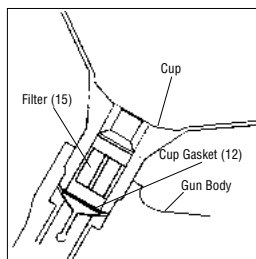

Gravity Cups PARTS & ASSEMBLY

Refer to Service Bulletins: SB-4-261 (GFC-501), TB-1003 (702576)
Refer to Part Sheets: 77-2739 (81-381) and 77-2719 (54-4458)

702576 TEKNA Gravity Feed Cup/Aluminum

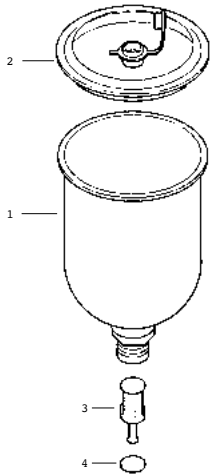

Ref. No.	Replacement Part No.	Description	Ind. Parts Req.
1	702576	Metal Gravity Feed Cup (900cc)	1
2	GFC-404-K2	Disposable Lid Kit (Kit of 2)	1
3	KGP-5-K5	Filter Kit (Kit of 5)	1
4	KGP-13-K5	Cup Gasket (Blue) (Kit of 5)	1

900875 (54-4458) 4 oz. Aluminum Cup

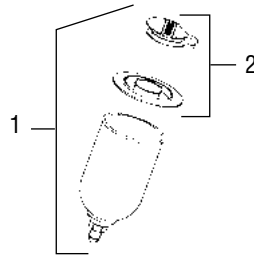

Ref. No.	Order No.	Model No.	Description	Ind. Parts Req.
1	900875	54-4458	Gravity Feed Cup Assembly (4 oz.)	1
2	900902	54-4539	4 oz. Cup Lid Assembly (Kit of 3)	1

190252 (GFC-501) Gravity Feed Cup/Acetal

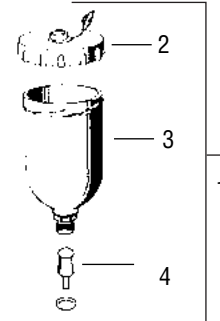

Ref. No.	Order No. Model No.	Description	Ind. Parts Req.
1	190252 GFC-501	Cup Assembly, 20 oz. Acetal	1
2	190225 GFC-402	Cup Lid Assembly	1
3	190181 KGP-5-K5	Filter (Kit of 5)	1
4	192151 KGP-13-K5	Cup Gasket (Blue) (Kit of 5)	1

● For GTI, FLG, M1-G, PRI and GFG Plus (Blue)

901430 (81-381) 8 oz. Aluminum Cup

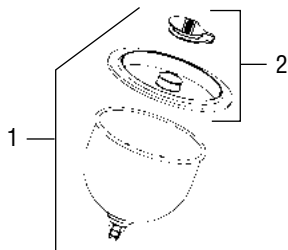

Ref. No.	Order No.	Model No.	Description	Ind. Parts Req.
1	901430	81-381	Gravity Feed Cup Assembly (8 oz.)	1
2	900787	54-4251	Cup Cover Kit (Kit of 3)	1

192191 (SRI-478-K12) 4 oz. Disposable Nylon Cup & Lid Kit

Contains 12 Cups and 12 Lids
(4 ea. Red, Yellow & Green)



803510 (DPC-503-K24) 3 oz. Plastic Cups and Lids Kit of 24

