

80i-110s

AC/DC Current Probe

Instructions

Introduction

The Fluke 80i-110s (the Probe or Product) is a clamp-on AC/DC Current Probe that reproduces current waveforms found in commercial and industrial power distribution systems. The Probe performance is optimized for accurate reproduction of currents at line frequency and up to the 50th harmonic waveform. The 80i-110s is also compatible with any instrument capable of millivolt measurements.

The Probe provides these benefits:

- Accurate AC, DC, and AC+DC current measurements for Electrical, Electronic, and Automotive applications.
- Shielded for high-noise immunity around electronic motor drives and ignition systems.
- Wide measurement range from 50 mA to 100 A, useful to 10 mA.
- Jaw shaped for easy access to cramped spaces.
- Tactile barrier (see Figure 1, item 1).
- Safety-designed 600 V insulated BNC - compatible with Fluke ScopeMeter® test tools, Power Harmonic analyzers, and oscilloscopes.
- Selectable output of 10 millivolts/1 amp for the 100 A range, and 100 mV/1 A for the 10 A range.

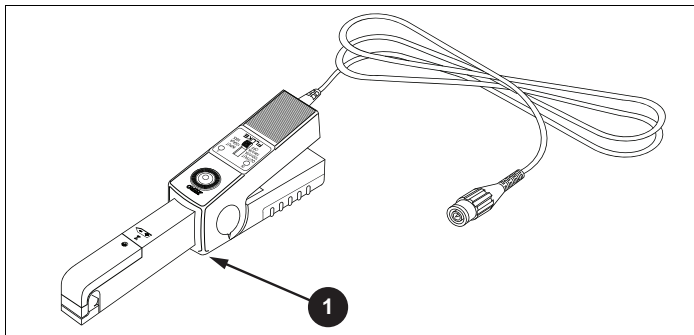

Figure 1. 80i-110s AC/DC Current Probe



How to Contact Fluke

To contact Fluke, call one of the following telephone numbers:

- Technical Support USA: 1-800-44-FLUKE (1-800-443-5853)
- Calibration/Repair USA: 1-888-99-FLUKE (1-888-993-5853)
- Canada: 1-800-36-FLUKE (1-800-363-5853)
- Europe: +31 402-675-200
- Japan: +81-3-6714-3114
- Singapore: +65-6799-5566
- Anywhere in the world: +1-425-446-5500

To view, print, or download the latest manual supplement, visit

<http://us.fluke.com/usen/support/manuals>.

Go to www.fluke.com to register your product and find more information.

Safety











A **Warning** identifies conditions and procedures that are dangerous to the user.

Warning

To prevent personal injury and for safe operation of the Product:

- Read all safety information before you use the Product.
- Carefully read all instructions.
- Do not use the Product if it is altered or damaged.
- Do not alter the Product and use only as specified, or the protection supplied by the Product can be compromised.
- Comply with local and national safety codes. Use personal protective equipment (approved rubber gloves, face protection, and flame-resistant clothes) to prevent shock and arc blast injury where hazardous live conductors are exposed.
- Hold the Product behind the tactile barrier.
- Before each use, examine the Product. Look for cracks or missing pieces of the clamp housing or output cable insulation. Also look for loose or weakened components. Carefully examine the insulation around the jaws.
- Do not touch voltages >30 V ac rms, 42 V ac peak, or 60 V dc.
- Use the Clamp only on insulated conductors. Use caution around bare conductors or bus bars. To prevent electrical shock, do not touch the conductor.

Symbols

Symbol	Definition
	WARNING - RISK OF DANGER.
	WARNING. HAZARDOUS VOLTAGE. Risk of electric shock.
	Consult user documentation.
	Double Insulated
	Earth
	Battery
	Application around and removal from uninsulated hazardous live conductors is permitted.
	Conforms to European Union directives.
	Conforms to relevant Australian Safety and EMC standards.
CAT III	Measurement Category III is applicable to test and measuring circuits connected to the distribution part of the building's low-voltage MAINS installation.
	This product complies with the WEEE Directive marking requirements. The affixed label indicates that you must not discard this electrical/electronic product in domestic household waste. Product Category: With reference to the equipment types in the WEEE Directive Annex I, this product is classed as category 9 "Monitoring and Control Instrumentation" product. Do not dispose of this product as unsorted municipal waste.

Before You Start

These items are included in the shipment box:

- AC/DC Current Probe, 80i-110s
- Instructions (this document)
- 9 volt Battery, type IEC 6LR61

Check the contents of the box for completeness. If something in the box is damaged or missing, contact your distributor or the nearest sales or service office.

Battery

⚠⚠ Warning

To prevent electrical shock, unclamp the Probe from any conductor, and disconnect the Scopemeter test tool or any other measurement device before you install or replace the battery.

Before the first use, install the battery. See Figure 2.

To install the battery:

1. Unclamp the Probe from any conductor and disconnect the ScopeMeter test tool or any other measurement device.
2. Make sure that the Probe is in the OFF position.
3. Locate the battery cover on the handle and loosen the screw with a flat-blade screwdriver.
4. Slide the battery cover away from the Probe.
5. Install the battery (IEC 6LR61). Arrange the battery leads so that they are not pinched between the handle bottom and the battery cover.
6. Reinstall the battery cover and secure the screw.

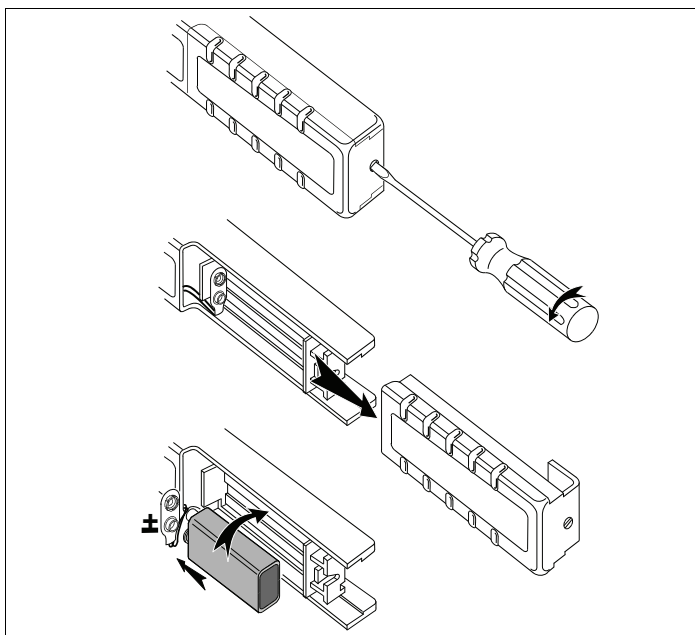

Figure 2. Battery Installation

⚠⚠ Warning

To prevent possible electrical shock, fire, or personal injury, replace the batteries when the low battery indicator shows to prevent incorrect measurements.

Compatibility

The Product is compatible with any Fluke ScopeMeter test tool, Power Harmonics Analyzer, Oscilloscope, Multimeter, or other voltage measurement device with these features:

- BNC input connector (PN PM9081/001 BNC-to-banana adapter) for use with standard inputs on a digital multimeter (DMM).
- Input accuracy of 2 % or better to take full advantage of the accuracy of the Probe.
- Input impedance of $\geq 1 \text{ M}\Omega$ in parallel with a maximum of 100 pF.
- A passband of more than four times the frequency of the waveform to be measured.

Instructions

To use the Probe:

1. Connect the Probe to the input on the measuring instrument. When the ScopeMeter test tool or an oscilloscope is used, it must have DC-coupled input. When you are using a digital multimeter, use the BNC-to- banana adapter (PM9081/001) to connect the Probe to the input.
2. On the Probe, select the least sensitive range (10 mV/A). Make sure that the green ON-indicator lights. See Figure 4 for selector switch and green On indicator locations.
3. On the Probe, rotate the ZERO thumbwheel to adjust the reading to zero. See Figure 4 for the ZERO rotary knob location.
4. Select the appropriate probe sensitivity on your ScopeMeter test tool or oscilloscope.
5. Clamp the Probe around the conductor. Make sure that the arrow mark on the jaw of the Probe points toward the correct orientation. See Figure 3.

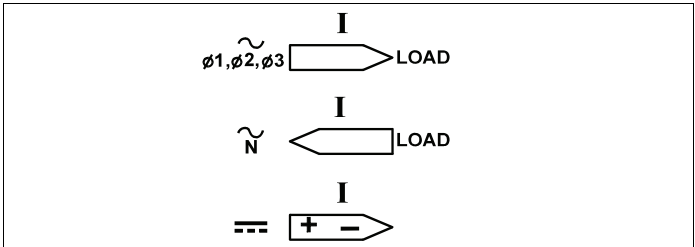

Figure 3. Current Probe Orientation

6. Observe the current value or waveform on your display or the current value readout on the multimeter.
7. On the ScopeMeter test tool, adjust the vertical range knob and time division knob for the best display.
8. If the red OL-indicator lights, the Probe is in overload mode.

9. At completion, set the range selection switch to OFF again. A measurement setup with the Probe and a ScopeMeter test tool is shown in Figure 4.

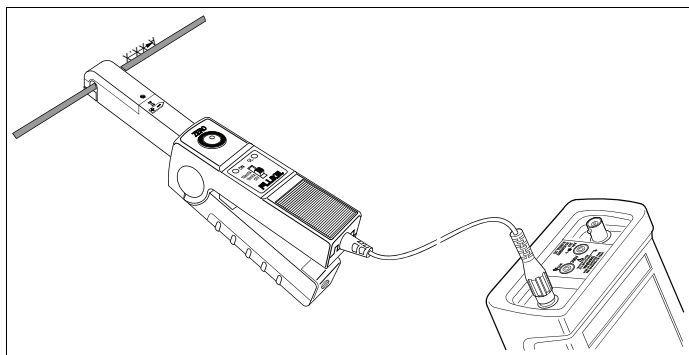



Figure 4. Measurement Setup

Measurement Guidelines

Use these guidelines to position the jaws:

- Center the conductor inside the jaws.
- Position the Probe perpendicular to the conductor.
- Make sure that the arrow marked  on the jaw of the Probe points toward the correct direction.

Use these guidelines to take measurements:

- If possible, avoid measurements close to other current-carrying conductors.
- On the Probe, the 100 mV/A range offers the best accuracy.

Maintenance

Before each use, inspect the Probe. Look for cracks or missing portions of the housing and output cable insulating cover and for loose or weakened components. Pay particular attention to the insulation surrounding the jaws. If a Probe fails this inspection, tape it shut to prevent unintended operation. To check Probe performance, complete the *Performance Verification* procedure.

Warning

To avoid electric shock:

- **Do not perform any service procedures unless you are qualified to do so.**
- **Read the "Safety" information at the beginning of this instruction sheet before proceeding.**

If the Probe does not perform properly, use these steps to help isolate the problem:

1. Test the battery. Be sure that the green ON-indicator lights when you select the 10 mV/A range or the 100 mV/A range.
2. Inspect the jaw mating surface for cleanliness. If any foreign material is present, the jaws will not close properly and errors will result.
3. Verify that the Probe is zeroed properly. For zeroing be sure that the ScopeMeter test tool or oscilloscope is DC-coupled.
4. Verify that the function selection on the ScopeMeter test tool or oscilloscope is correct, for example, the display vertical resolution is not too low or too high.

Repairs or service not covered in this document must be performed only at a Fluke Service Center. A Probe under warranty will be repaired or replaced (at Fluke's discretion) and returned at no charge.

Cleaning and Storage

Periodically wipe the case with a damp cloth and detergent. Do not use abrasives or solvents. Open the jaws and wipe the magnetic pole pieces with a lightly oiled cloth. Do not allow rust or corrosion to form on the magnetic core ends.

If the Probe is not used for long time periods (>60 days) the battery should be removed and stored separately.

Accessories

An adapter accessory is required to use the Probe with a digital multimeter. The BNC-to-Banana Adapter, Fluke Part PM9081/001, is available to order.

Specifications

Maximum Voltage between any Terminal and Earth Ground.....	600 V
Dimensions.....	67 mm x 231 mm x 36 mm (2.6 in x 9.1 in x 1.4 in)
Weight	330 g (11.6 oz), battery included
Output Cable	1.6 m (63 in)
Maximum Conductor Size	11.8 mm (0.46 in)
Maximum Jaw Opening.....	12.5 mm (0.49 in)
Temperature	
Operating.....	0 °C to 50 °C (32 °F to 122 °F)
Storage.....	-30 °C to +70 °C (-22 °F to +158 °F)
Relative Humidity (Operating)	
0 % to 85 %	0 °C to 35 °C (32 °F to 95 °F)
0 % to 45 %	35 °C to 50 °C (95 °F to 122 °F)
Altitude	
Operating.....	<2000 m (<6560 ft)
Storage.....	<12 000 m (<40 000 ft)
Demagnetize Probe.....	Open and close Probe jaws several times

Battery

Type	9 volt, IEC 6LR61
Consumption	8.6 mA typical 12 mA maximum
Service life with Alkaline IEC 6LR61 battery	
Typical.....	55 hours
Minimum.....	40 hours
Battery indicator (ON).....	Green LED dims when battery voltage is <6.5 V

Safety

General.....	IEC 61010-1: Pollution Degree 2
Measurement	IEC 61010-2-032: CAT III 600 V

Electromagnetic Compatibility (EMC)

International.....	IEC 61326-1: Portable Electromagnetic Environment CISPR 11: Group 1, Class A
--------------------	--

Group 1: Equipment has intentionally generated and/or use conductively coupled radio-frequency energy which is necessary for the internal functioning of the equipment itself.

Class A: Equipment is suitable for use in all establishments other than domestic and those directly connected to a low voltage power supply network which supplies buildings used for domestic purposes. There may be potential difficulties in ensuring electromagnetic compatibility in other environments, due to conducted and radiated disturbances.

Caution: This equipment is not intended for use in residential environments and may not provide adequate protection to radio reception in such environments.

Emissions that exceed the levels required by CISPR 11 can occur when the equipment is connected to a test object.

USA (FCC)

47 CFR 15 subpart B. This product is considered an exempt device per clause 15.103.

Electrical Specifications

Valid temperature	23 °C ±3 °C (73 °F ±5 °F).
Current Ranges	0 A dc to 10 A dc or ac peak 0 A dc to 100 A dc or ac peak
Output Signals	10 A range: 100 mV/A 100 A range: 10 mV/A

Basic Accuracy (DC to 1kHz):

Input Current (DC or AC peak)	Error (after zero check)	
	Range 100 mV/A	Range 10 mV/A
0 A to 10 A	<3 % of reading +50 mA	-
0 A to 40 A	-	<4 % of reading +50 mA
40 A to 80 A	-	<12 % of reading +50 mA
80 A to 100 A	-	<15 % of reading

Extended Accuracy:

For other frequencies, refer to the appropriate input current range and add the error listed below to the "Basic Accuracy" error.

Frequency	Additional Error	
	Range 100 mV/A	Range 10 mV/A
1 kHz to 5 kHz	3 %	3 %
5 kHz to 20 kHz	12 %	12 %
>20 kHz	not specified	not specified

Input Load Impedance

(of host instrument) >1 M Ω in parallel with up to 100 pF

Useful Bandwidth (-3 dB) 0 kHz to 100 kHz

Rise or Fall Time <4 μ sec

Output noise level

Range 10 mV/A typical..... 480 μ V pk-pk

Range 100 mV/A typical..... 3 mV pk-pk

Max. nondestructive current 0 kHz to 2 kHz 140 A peak
2 kHz to 10 kHz 110 A peak
10 kHz to 20 kHz 70 A peak
20 kHz to 50 kHz 30 A peak
50 kHz to 100 kHz 20 A peak

Temperature coefficient..... 2000 ppm/ $^{\circ}$ C max. for temperature from 0 $^{\circ}$ C to 50 $^{\circ}$ C (32 $^{\circ}$ F to 132 $^{\circ}$ F)

Performance Verification

Verify Probe accuracy with the test setup shown in Figure 5. Required test equipment is defined in Table 1. Toroid coil construction is illustrated in Table 2.

To verify the Probe accuracy:

1. Set up connection.
2. Make the checks called for in Table 3 (100 mV/A).
3. Make the checks called for in Table 4 (10 mV/A).

Table 1. Required Test Equipment

Required	Recommended
AD/DC Calibrator	Fluke 5520A
Digital Multimeter (DMM)	Fluke 45
Small insulated screwdriver	Spectrol
Banana-to-BNC Adapter	Fluke PM9081/001
10-turn Toroid Coil	See Figure 6

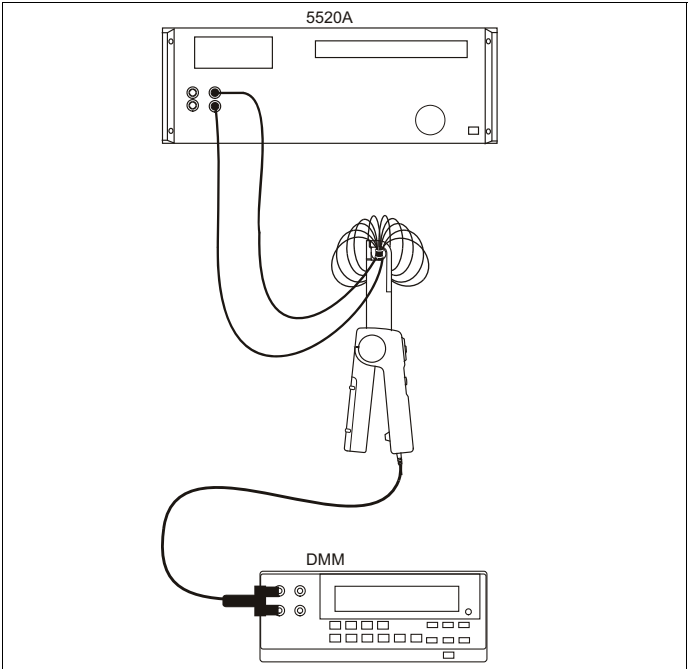
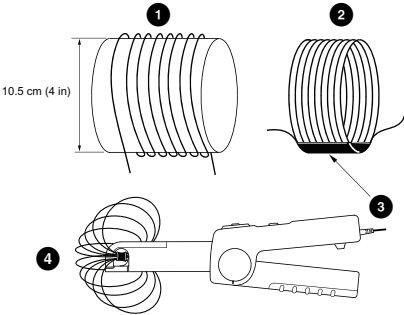

Figure 5. Performance Test and Calibration Setup

Table 2. Toroid Coil Construction

Item	Description
1	10 turns wound on cylindrical form using 10-gauge magnet wire.
2	Remove form and tape coil together making sure 10 wires are taped.
3	Tape
4	Fan out coil to approximately 270° with spacing 5 cm (2 in) using tape to maintain coil shape.



**Table 3. Performance Test Points:
Current Range 0 A to 10 A (100 mV/A)**

DC Measurement:			
5520A Settings	DC Amps Measured	Low Limit Output	High Limit Output
0.1 A	1 A	92 mV	108 mV
0.5 A	5 A	480 mV	520 mV
0.9 A	9 A	868 mV	932 mV
AC Measurement:			
5520A Settings	RMS Amps Measured	Low Limit Output	High Limit Output
0.1 A, 60 Hz	1 A	92 mV	108 mV
0.3 A, 400 Hz	3 A	286 mV	314 mV
0.5 A, 2 kHz	5 A	465 mV	535 mV
0.6 A, 4 kHz	6 A	559 mV	641 mV

**Table 4. Performance Test Points:
Current Range 0 A to 100 A (10 mV/A)**

DC Measurement:			
5520A Settings	DC Amps Measured	Low Limit Output	High Limit Output
1 A	10 A	95.5 mV	104.5 mV
3 A	30 A	287.5 mV	312.5 mV
5 A	50 A	439.5 mV	560.5 mV
7 A	70 A	615.5 mV	784.5 mV
9 A	90 A	765.0 mV	1035.0 mV
AC Measurement:			
5520A Settings	RMS Amps Measured	Low Limit Output	High Limit Output
1 A, 5 kHz	10 A	92.5 mV	107.5 mV
2 A, 1 kHz	20 A	185.5 mV	214.5 mV
3 A, 400 Hz	30 A	287.5 mV	312.5 mV
5 A, 400 Hz	50 A	439.5 mV	560.5 mV
7 A, 60 Hz	70 A	595.0 mV	805.0 mV

LIMITED WARRANTY AND LIMITATION OF LIABILITY

This Fluke product will be free from defects in material and workmanship for one year from the date of purchase. This warranty does not cover fuses, disposable batteries, or damage from accident, neglect, misuse, alteration, contamination, or abnormal conditions of operation or handling. Resellers are not authorized to extend any other warranty on Fluke's behalf. To obtain service during the warranty period, contact your nearest Fluke authorized service center to obtain return authorization information, then send the product to that Service Center with a description of the problem.

THIS WARRANTY IS YOUR ONLY REMEDY. NO OTHER WARRANTIES, SUCH AS FITNESS FOR A PARTICULAR PURPOSE, ARE EXPRESSED OR IMPLIED. FLUKE IS NOT LIABLE FOR ANY SPECIAL, INDIRECT, INCIDENTAL OR CONSEQUENTIAL DAMAGES OR LOSSES, ARISING FROM ANY CAUSE OR THEORY. Since some states or countries do not allow the exclusion or limitation of an implied warranty or of incidental or consequential damages, this limitation of liability may not apply to you.

Fluke Corporation
P.O. Box 9090
Everett, WA 98206-9090
U.S.A.

Fluke Europe B.V.
P.O. Box 1186
5602 BD Eindhoven
The Netherlands

11/99