



SERIES 487 OFFICE PARTITION SYSTEM
SINGLE SLIDING DOOR W/ SINGLE SLIDER SIDELITE, W/ AND W/O TRANSOM
SHOWN WITH OPTIONAL CRL WOOD FLUSH DOOR

Revisions By:

CRL ALUMINUM
 C.R. LAURENCE CO. ARCHITECTURAL PRODUCTS
 2503 E. Vermont Avenue, Los Angeles, CA 90058-1897
 PH: (800)-421-6144 FAX: 800-587-7261 www.crlaluminum.com

Description:
 CRL 487-1.5 OFFICE
 PARTITION SYSTEM SLIDERS
 WOOD DOOR SLIDERS

Drawn By: AAD
 Date: 3/7/17
 Scale: AS NOTED
 File Name:
 CRL 487-Series Office Partition
 System Sliders.dwg
 Sheet

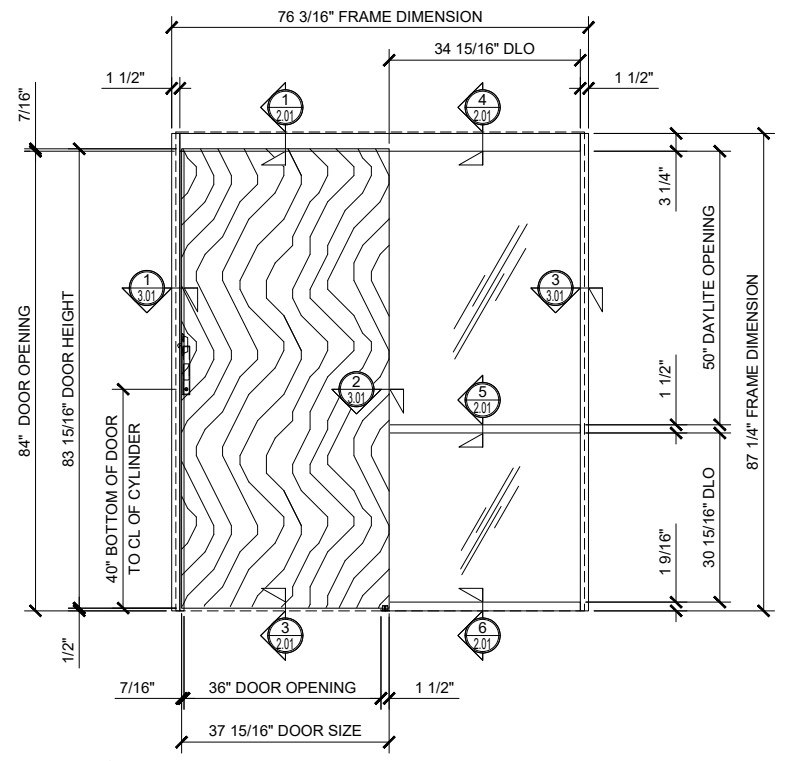

① SINGLE SLIDER WITH SINGLE SIDELITE (CLOSED)
 ARCH REF: NONE 3/4"=1'-0"

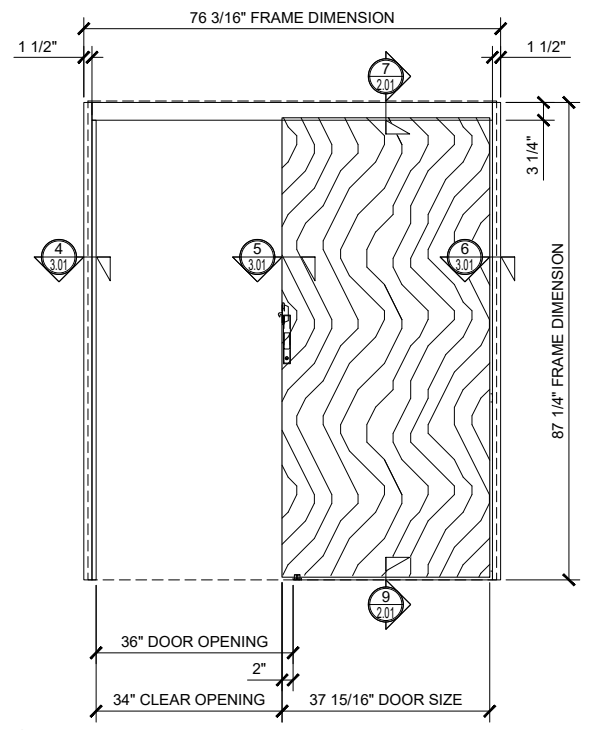

② SINGLE SLIDER WITH SINGLE SIDELITE (OPEN)
 ARCH REF: NONE 3/4"=1'-0"

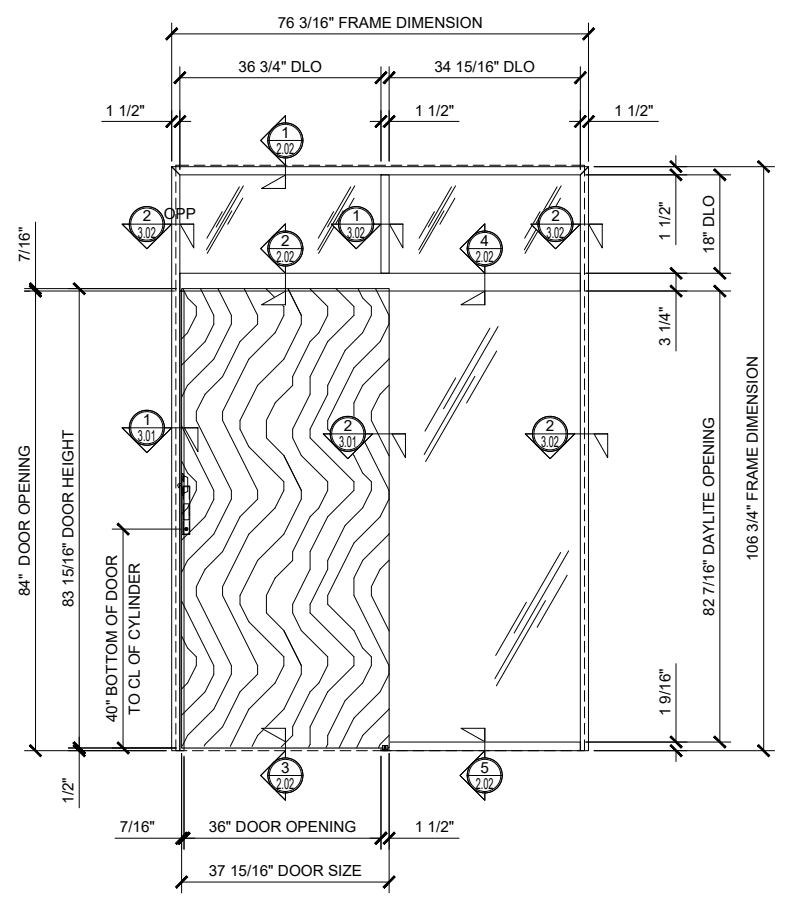

③ SINGLE SLIDER WITH TRANSOM AND SINGLE SIDELITE (CLOSED)
 ARCH REF: NONE 3/4"=1'-0"

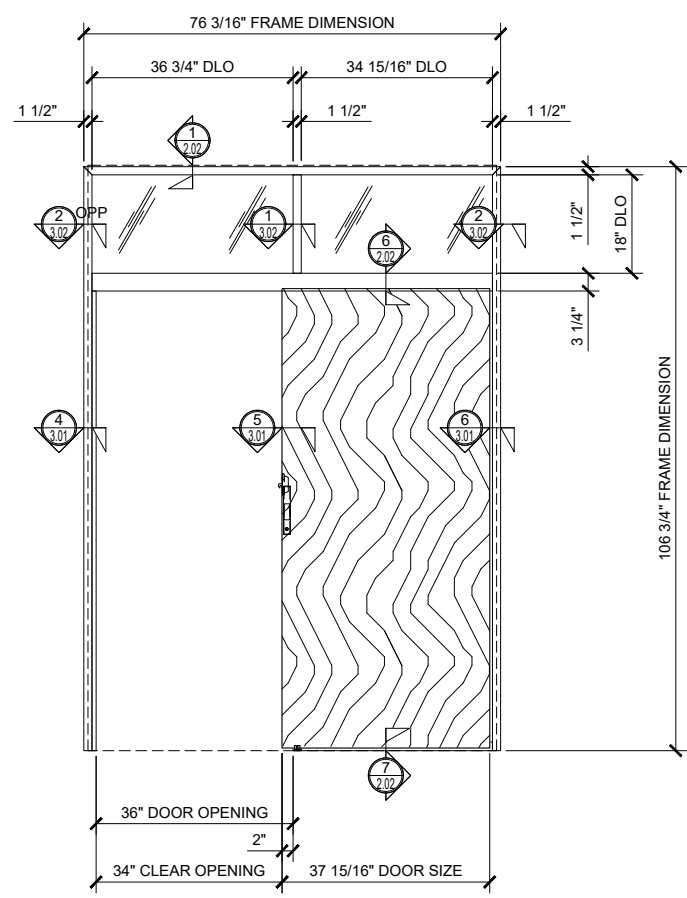

④ SINGLE SLIDER WITH TRANSOM AND SINGLE SIDELITE (OPEN)
 ARCH REF: NONE 3/4"=1'-0"



SERIES 487 OFFICE PARTITION SYSTEM
SINGLE SLIDING DOOR W/ SLIDER SIDELITE-REGULAR SIDELITE, W/ AND W/O TRANSOM
SHOWN WITH OPTIONAL CRL WOOD FLUSH DOOR

Revisions By:

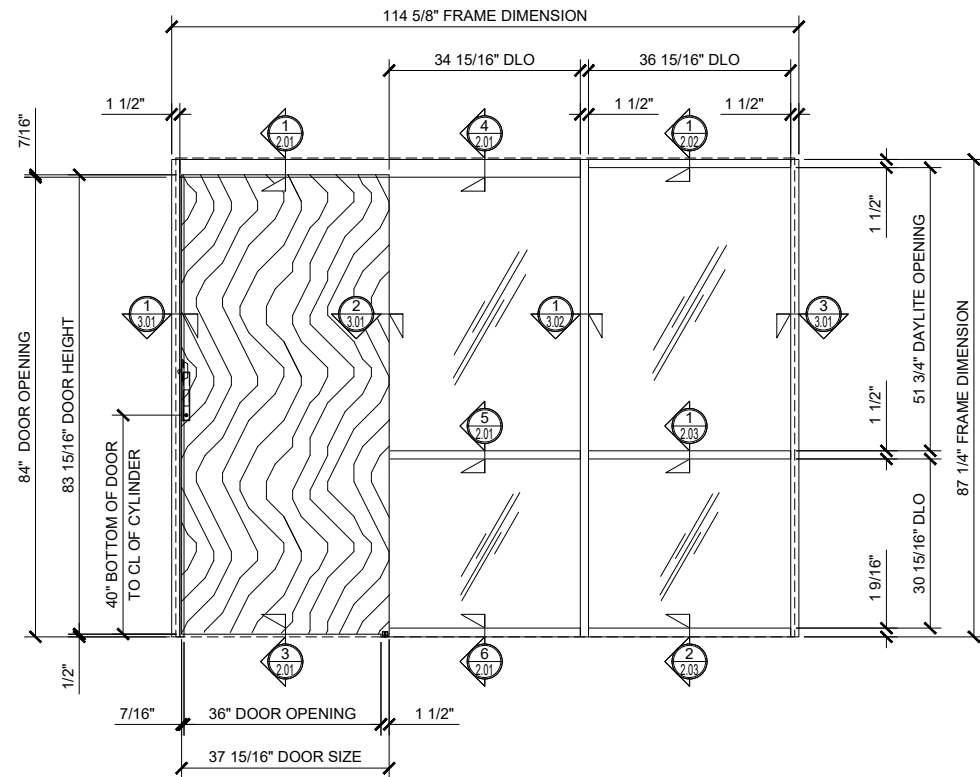

① SINGLE SLIDER WITH DOUBLE SIDELITE (CLOSED)

ARCH REF: NONE 3/4"=1'-0"

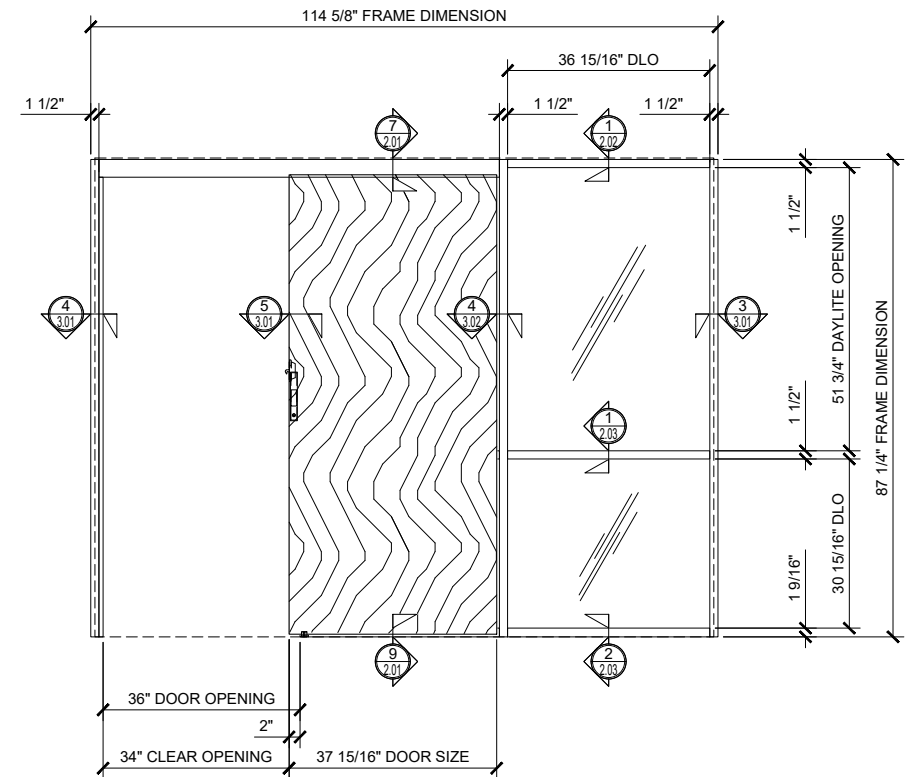

② SINGLE SLIDER WITH DOUBLE SIDELITE (OPEN)

ARCH REF: NONE 3/4"=1'-0"

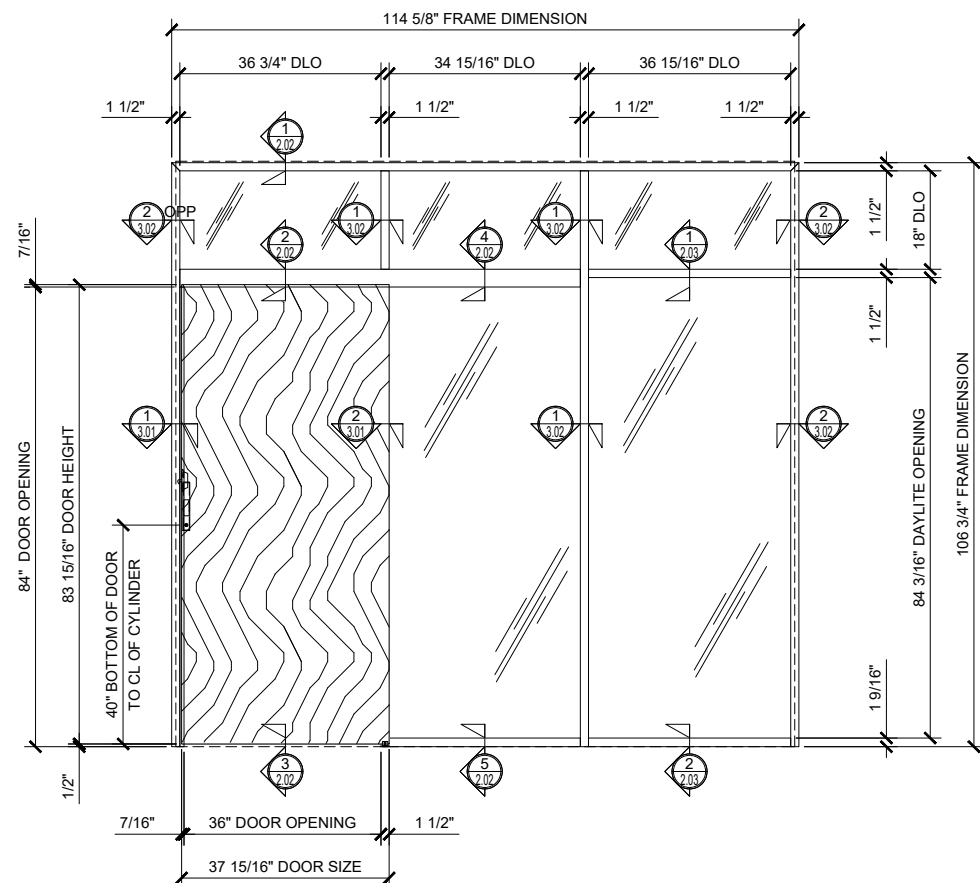

③ SINGLE SLIDER WITH TRANSOM AND DOUBLE SIDELITE (CLOSED)

ARCH REF: NONE 3/4"=1'-0"

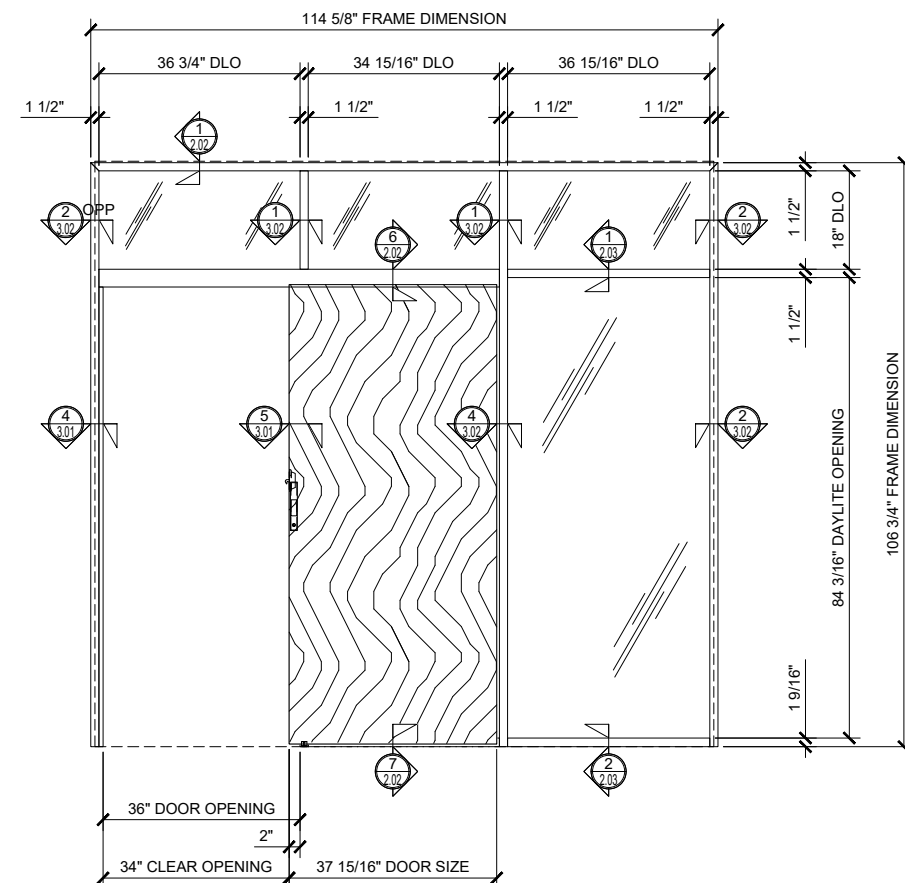

④ SINGLE SLIDER WITH TRANSOM AND DOUBLE SIDELITE (OPEN)

ARCH REF: NONE 3/4"=1'-0"



Discription:
CRL 487-1.5 OFFICE
PARTITION SYSTEM SLIDERS
WOOD DOOR SLIDERS

Drawn By: AAD
 Date: 3/7/17
 Scale: AS NOTED
 File Name: CRL 487-Series Office Partition System Sliders.dwg

Sheet



SERIES 487 OFFICE PARTITION SYSTEM
SINGLE SLIDING DOOR W/ DUAL SLIDER SIDELITES, W/ AND W/O TRANSOM
SHOWN WITH OPTIONAL CRL WOOD FLUSH DOOR

Revisions By:

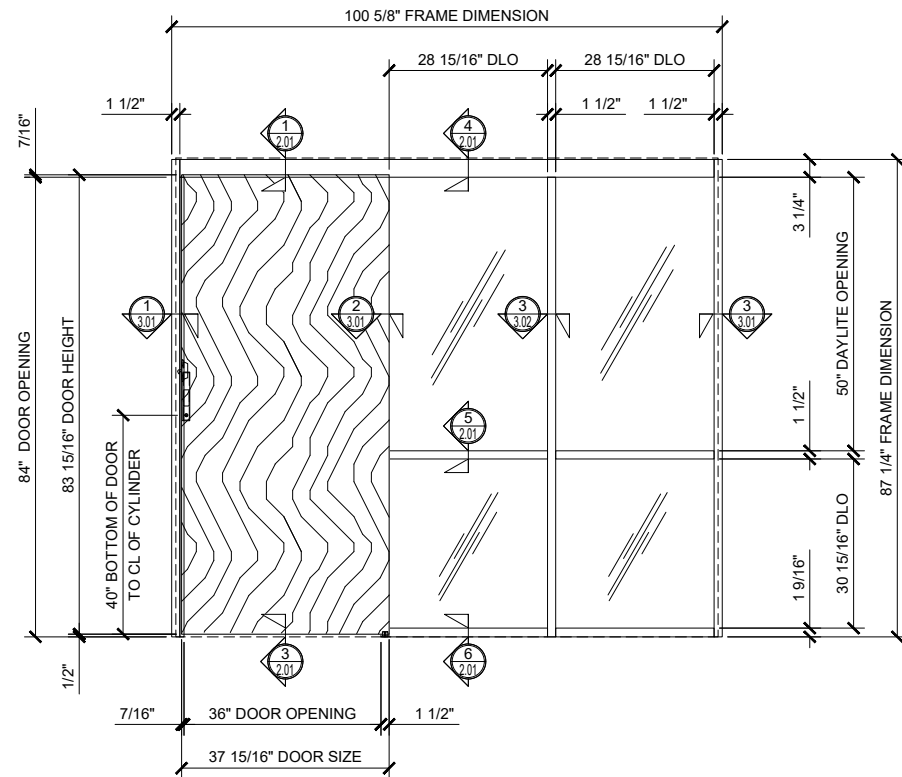

① SINGLE SLIDER WITH DOUBLE SIDELITE (CLOSED)

ARCH REF: NONE 3/4"=1'-0"

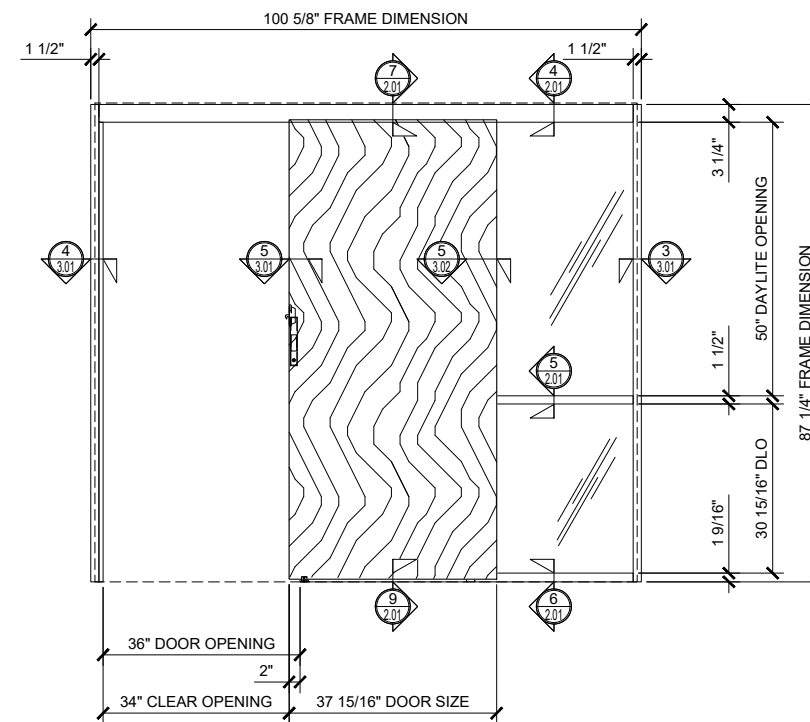

② SINGLE SLIDER WITH DOUBLE SIDELITE (OPEN)

ARCH REF: NONE 3/4"=1'-0"

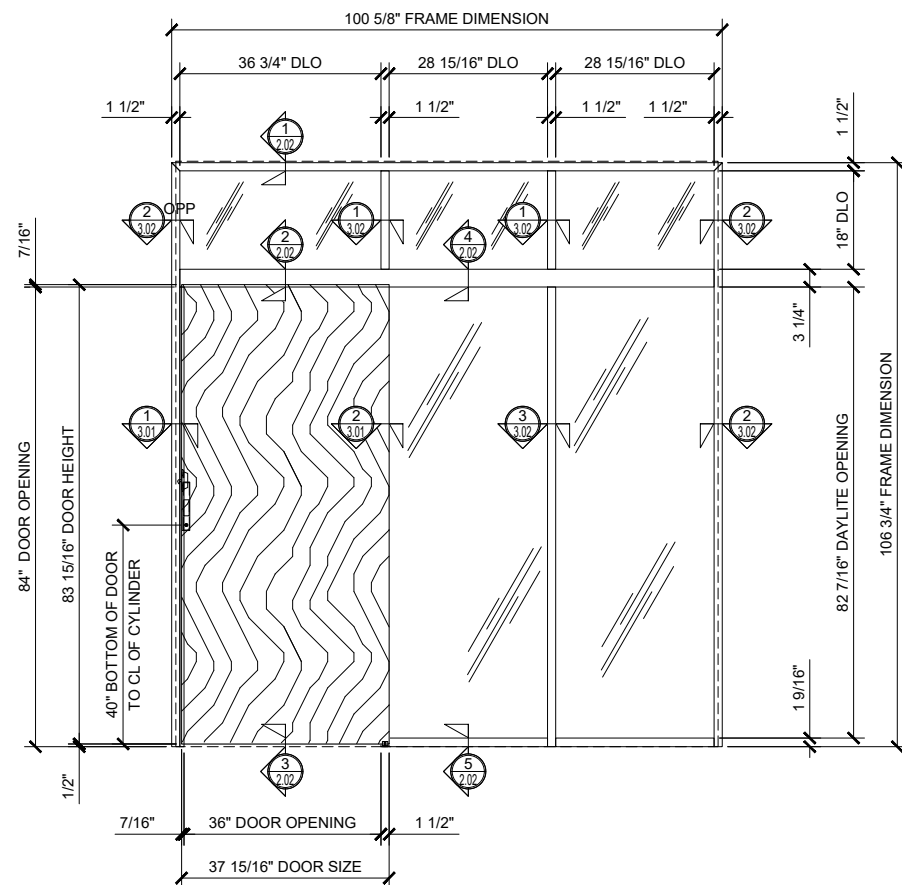

③ SINGLE SLIDER WITH TRANSOM AND DOUBLE SIDELITE (CLOSED)

ARCH REF: NONE 3/4"=1'-0"

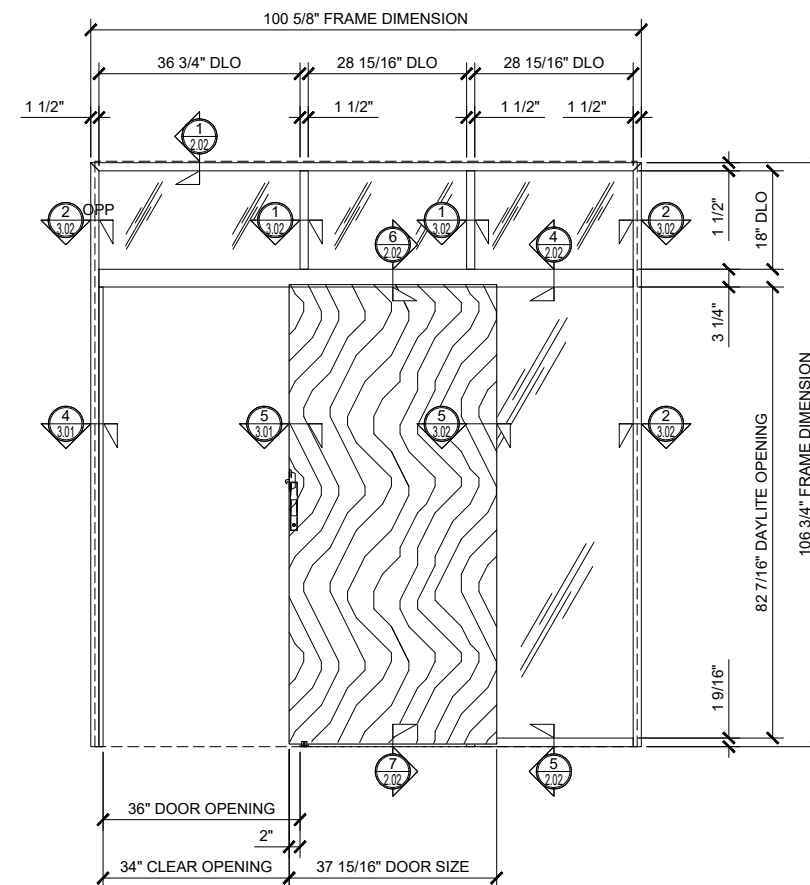

④ SINGLE SLIDER WITH TRANSOM AND DOUBLE SIDELITE (OPEN)

ARCH REF: NONE 3/4"=1'-0"



Description:
CRL 487-1.5 OFFICE
PARTITION SYSTEM SLIDERS
WOOD DOOR SLIDERS

Drawn By: AAD
 Date: 3/7/17
 Scale: AS NOTED
 File Name: CRL 487-Series Office Partition System Sliders.dwg
 Sheet



SERIES 487 OFFICE PARTITION SYSTEM
DOUBLE SLIDING DOOR W/ SINGLE SLIDER SIDELITE AT EACH SIDE, W/ AND W/O TRANSOM
SHOWN WITH OPTIONAL WOOD FLUSH DOOR

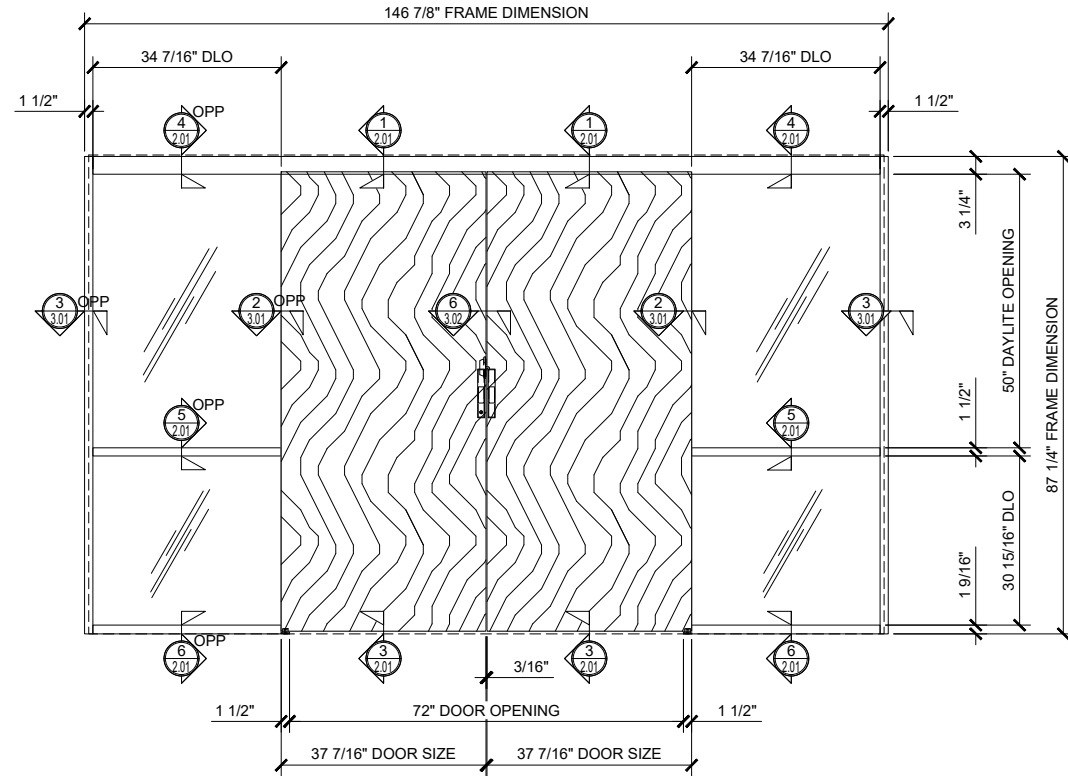

① BI-PART SLIDER WITH SINGLE SIDELITES (CLOSED)
 ARCH REF: NONE 3/4"=1'-0"

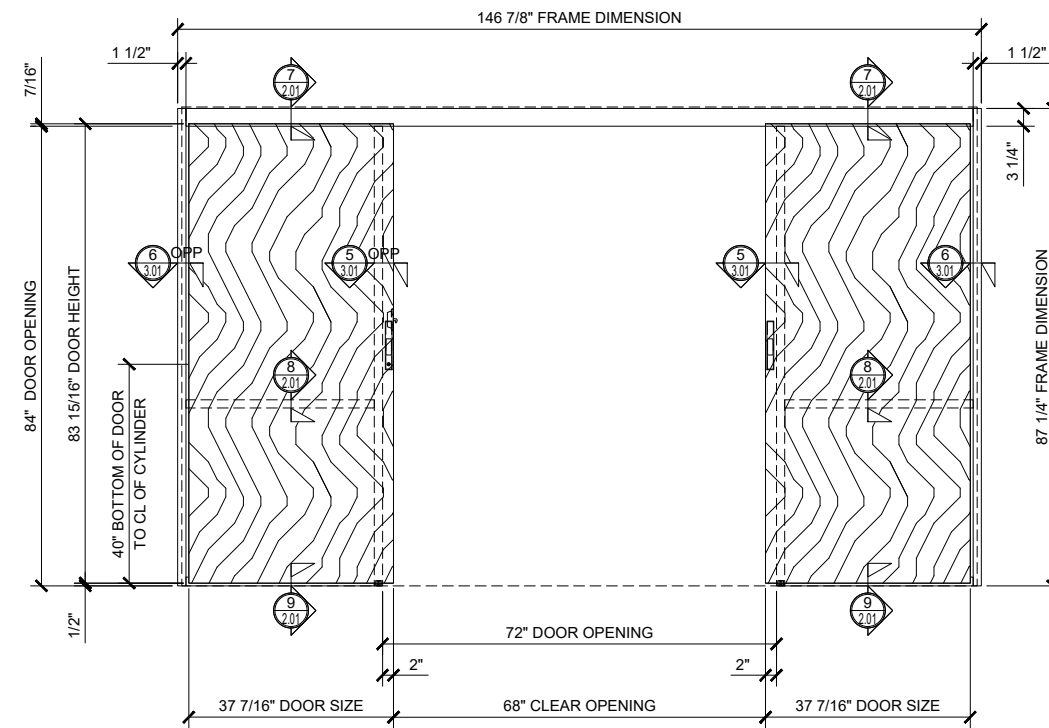

② BI-PART SLIDER WITH SINGLE SIDELITES (OPEN)
 ARCH REF: NONE 3/4"=1'-0"

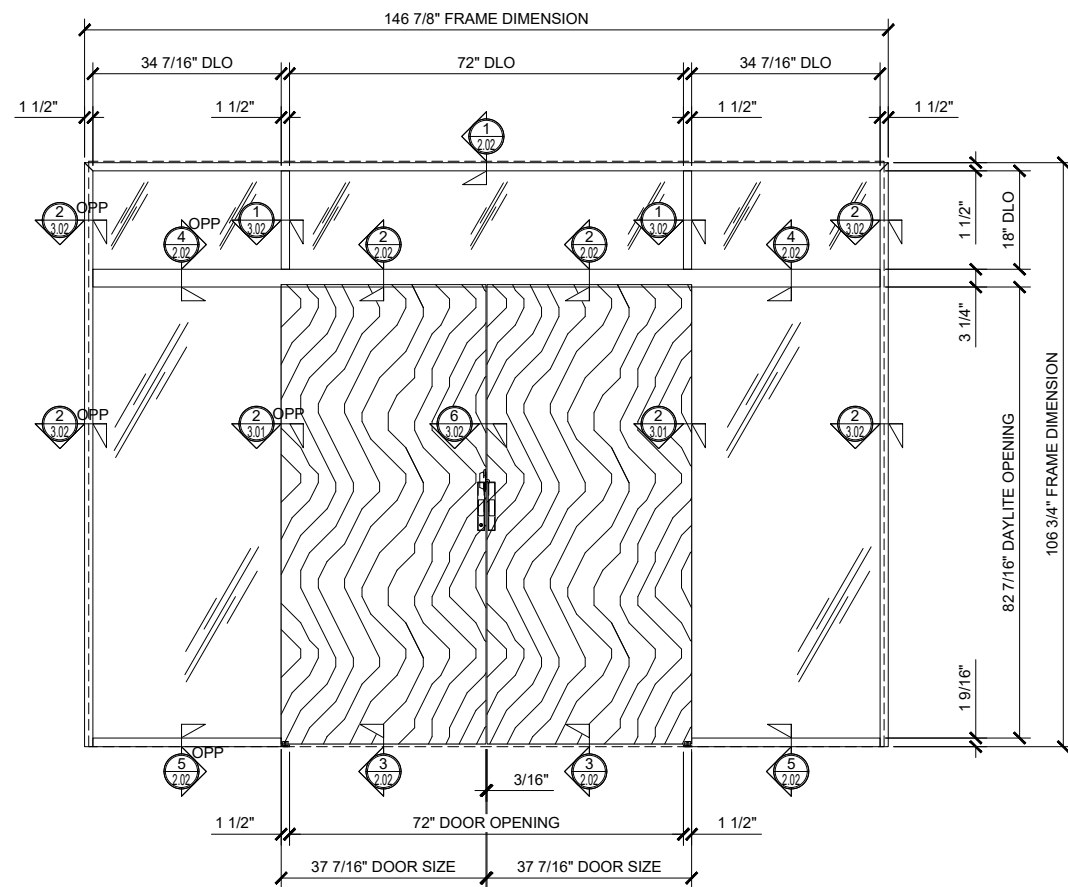

③ BI-PART SLIDER WITH TRANSOM AND SINGLE SIDELITES (CLOSED)
 ARCH REF: NONE 3/4"=1'-0"

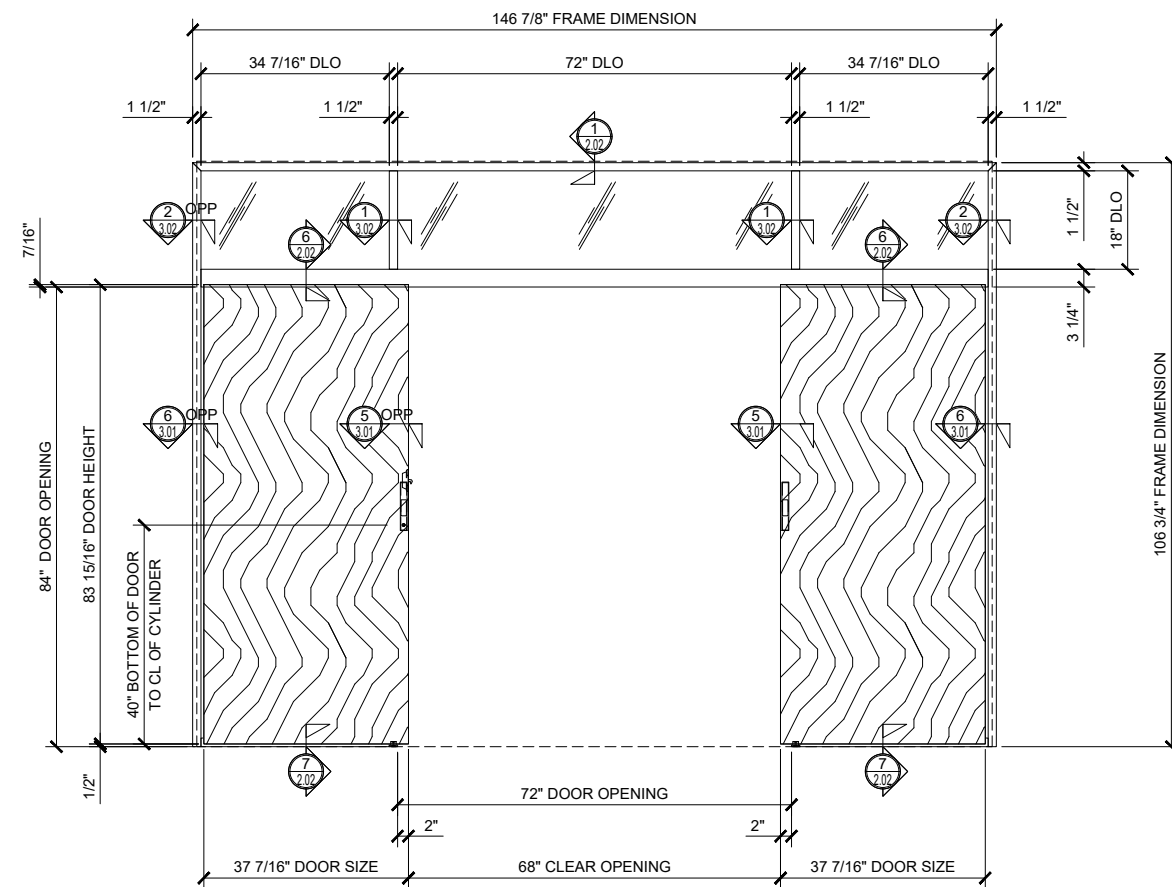

④ BI-PART SLIDER WITH TRANSOM AND SINGLE SIDELITES (OPEN)
 ARCH REF: NONE 3/4"=1'-0"

Revisions By:



C.R. LAURENCE CO. ARCHITECTURAL PRODUCTS
 2503 E. Vernon Avenue, Los Angeles, CA 90058-1897
 PH: (800)-471-6144 FX: (800)-587-7261 www.crlaurence.com

Discussion:

CRL 487-1.5 OFFICE
 PARTITION SYSTEM SLIDERS
 WOOD DOOR SLIDERS

Drawn By: AAD
 Date: 3/7/17
 Scale: AS NOTED
 File Name:
 CRL 487-Series Office Partition
 System Sliders.dwg
 Sheet



SERIES 487 OFFICE PARTITION SYSTEM
DOUBLE SLIDING DOOR W/ SLIDER SIDELITE-REGULAR SIDELITE AT EACH SIDE, W/ AND W/O TRANSOM
SHOWN WITH OPTIONAL CRL WOOD FLUSH DOOR

Revisions By:

C.R. LAURENCE CO. ARCHITECTURAL PRODUCTS
 2503 E. Vernon Avenue, Los Angeles, CA 90058-1897
 PH: (800)-471-6144 FAX: 800-587-7261 www.crlaurence.com

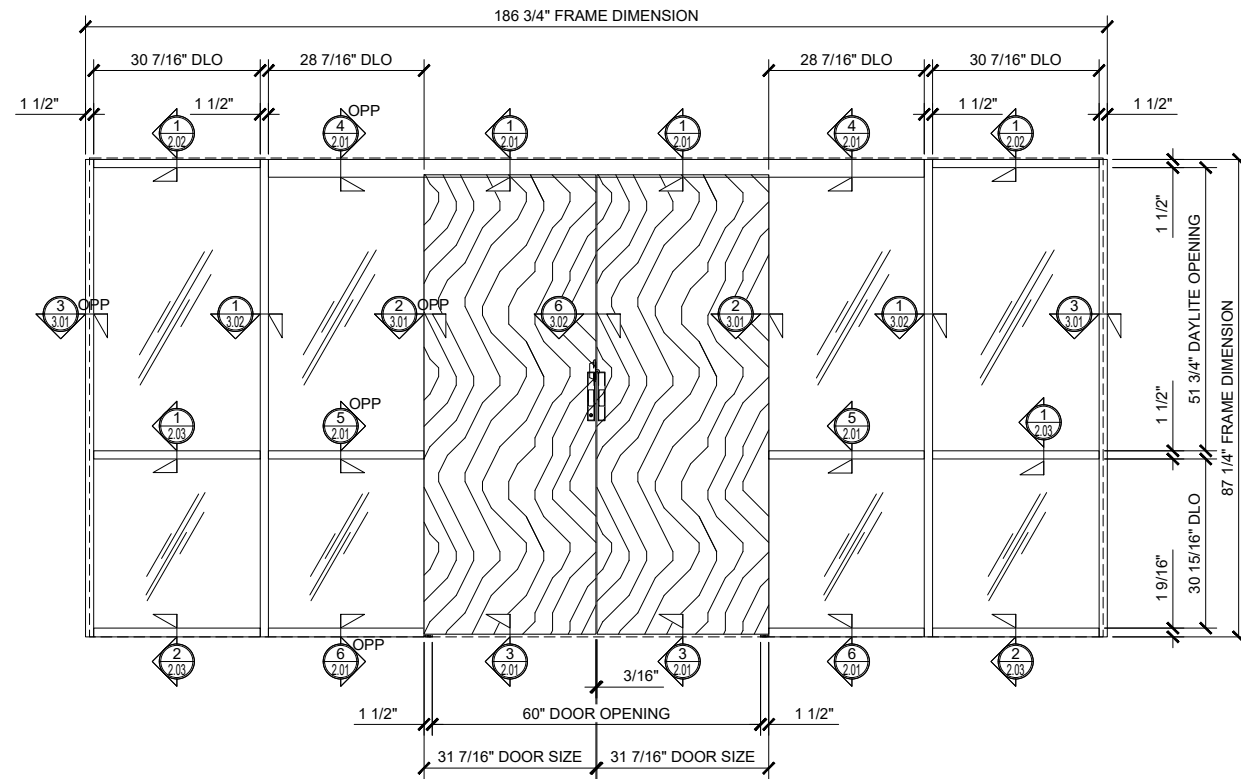

1 BI-PART SLIDER WITH SINGLE SIDELITES (CLOSED)

ARCH REF: NONE

3/4"=1'-0"

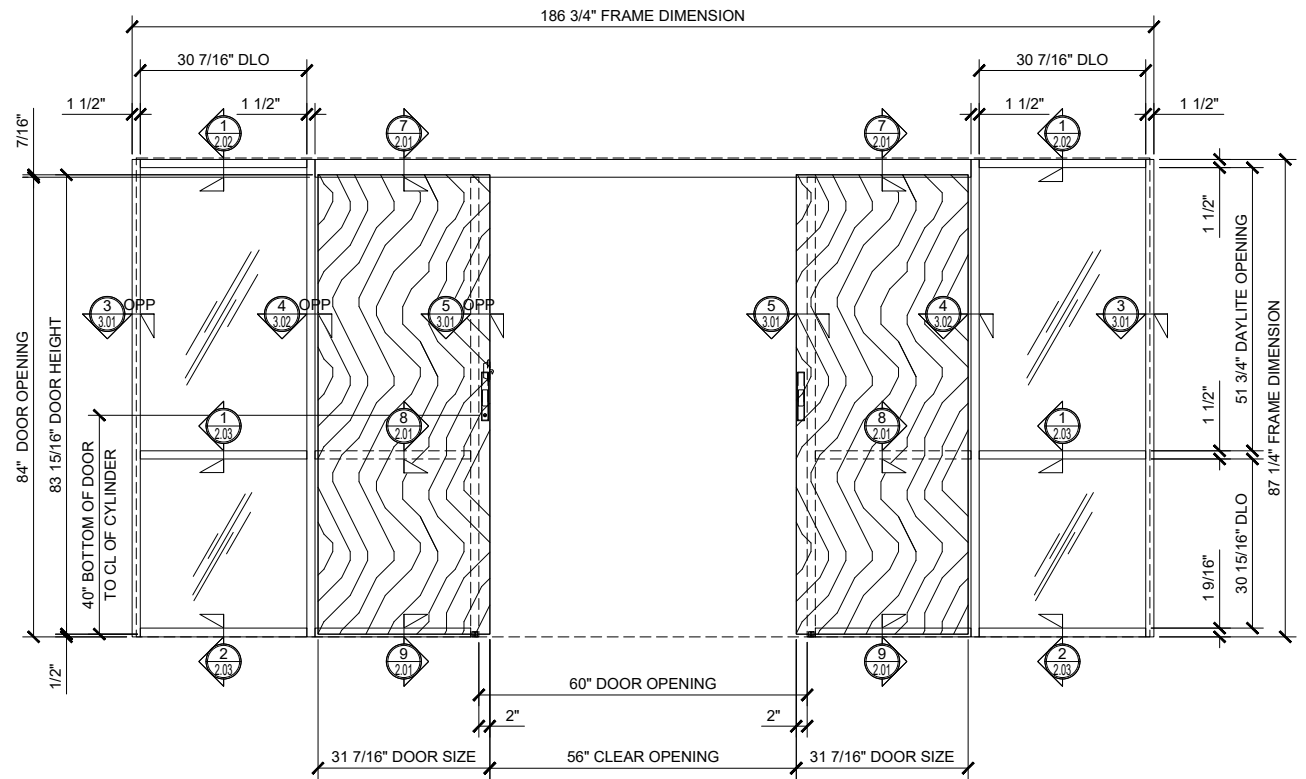

2 BI-PART SLIDER WITH SINGLE SIDELITES (OPEN)

ARCH REF: NONE

3/4"=1'-0"

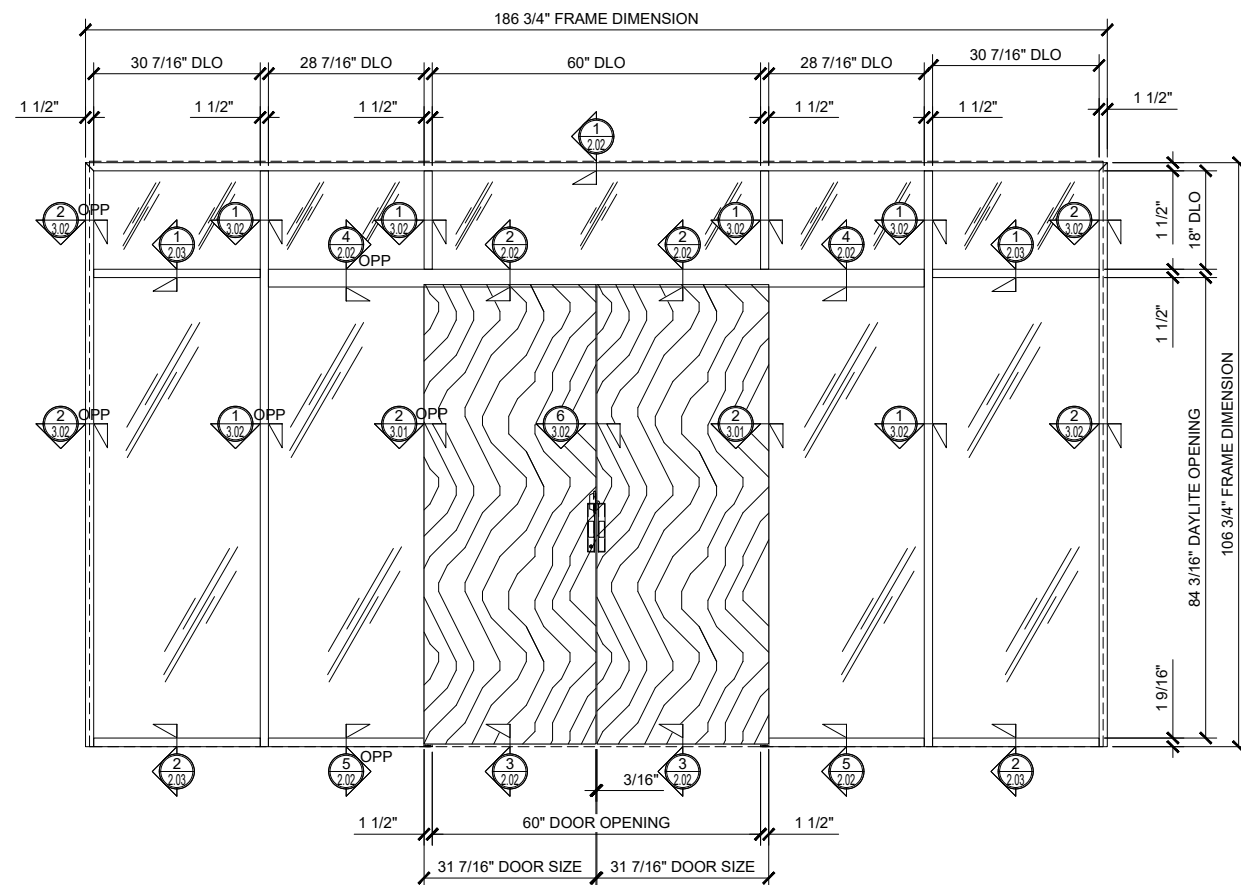

3 BI-PART SLIDER WITH TRANSOM AND SINGLE SIDELITES (CLOSED)

ARCH REF: NONE

3/4"=1'-0"

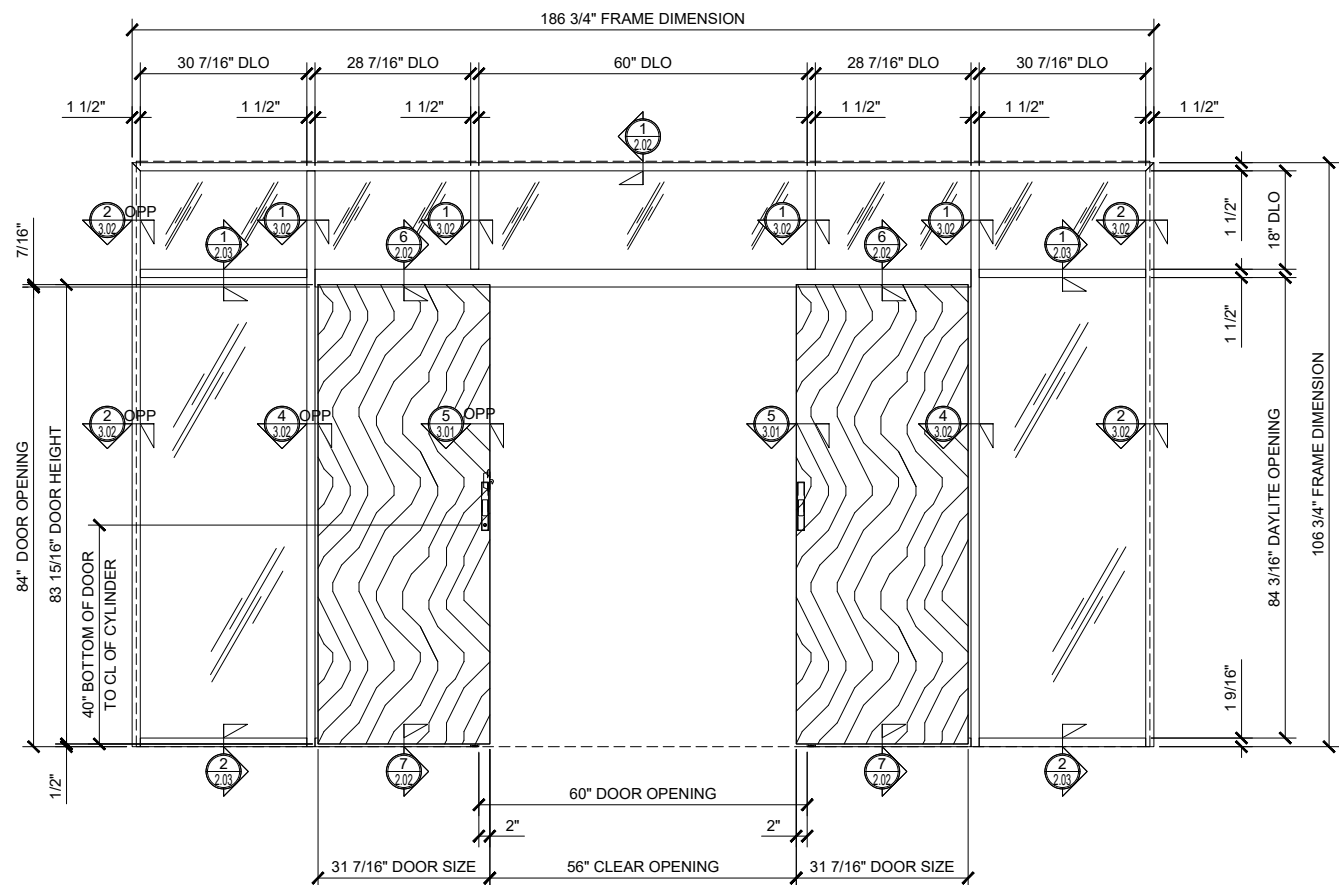

4 BI-PART SLIDER WITH TRANSOM AND SINGLE SIDELITES (OPEN)

ARCH REF: NONE

3/4"=1'-0"

Description:

CRL 487-1.5 OFFICE
 PARTITION SYSTEM SLIDERS
 WOOD DOOR SLIDERS

Drawn By: AAD

Date: 3/7/17

Scale: AS NOTED

File Name:
 CRL 487-Series Office Partition
 System Sliders.dwg

Sheet



SERIES 487 OFFICE PARTITION SYSTEM
DOUBLE SLIDING DOOR W/ DUAL SLIDER SIDELITES AT EACH SIDE, W/ AND W/O TRANSOM
SHOWN WITH OPTIONAL CRL WOOD FLUSH DOOR

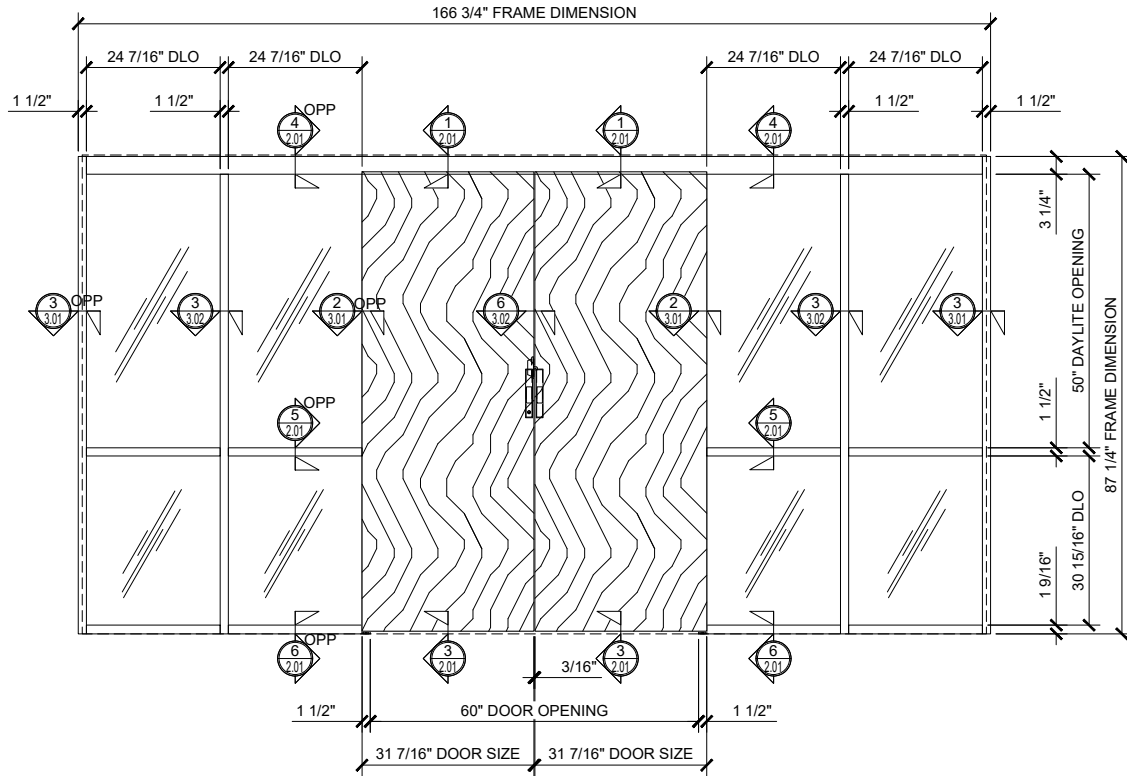

① BI-PART SLIDER WITH SINGLE SIDELITES (CLOSED)

ARCH REF: NONE 3/4"=1'-0"

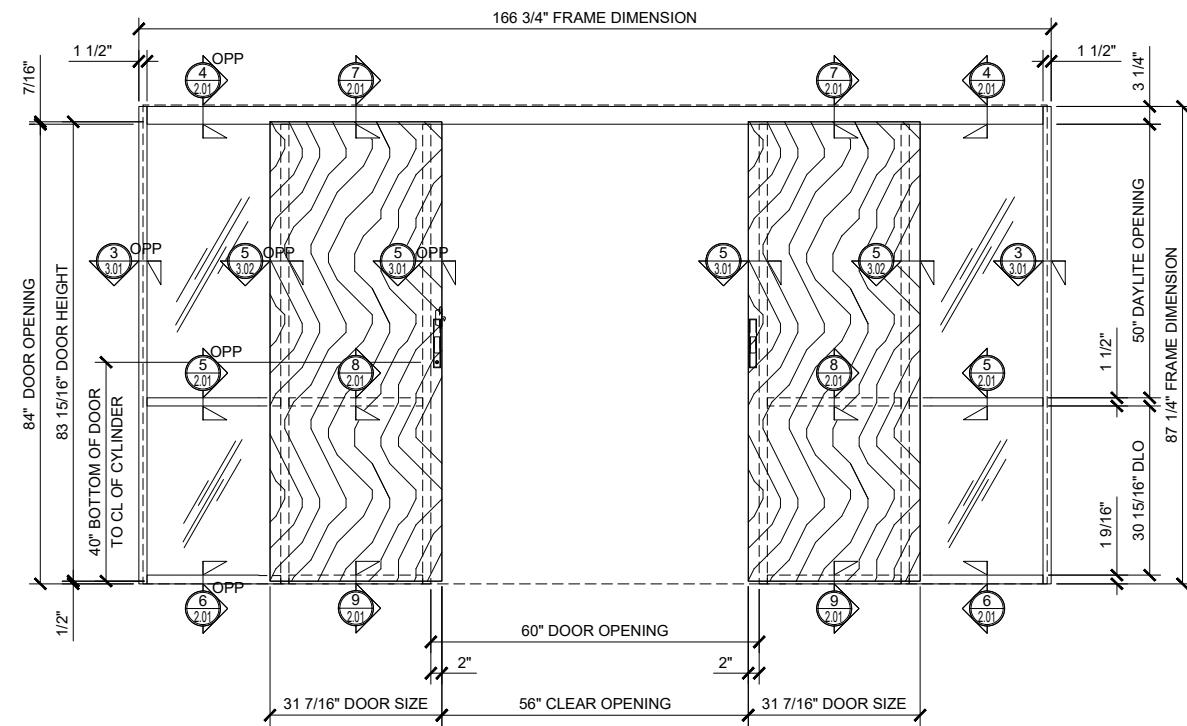

② BI-PART SLIDER WITH SINGLE SIDELITES (OPEN)

ARCH REF: NONE 3/4"=1'-0"

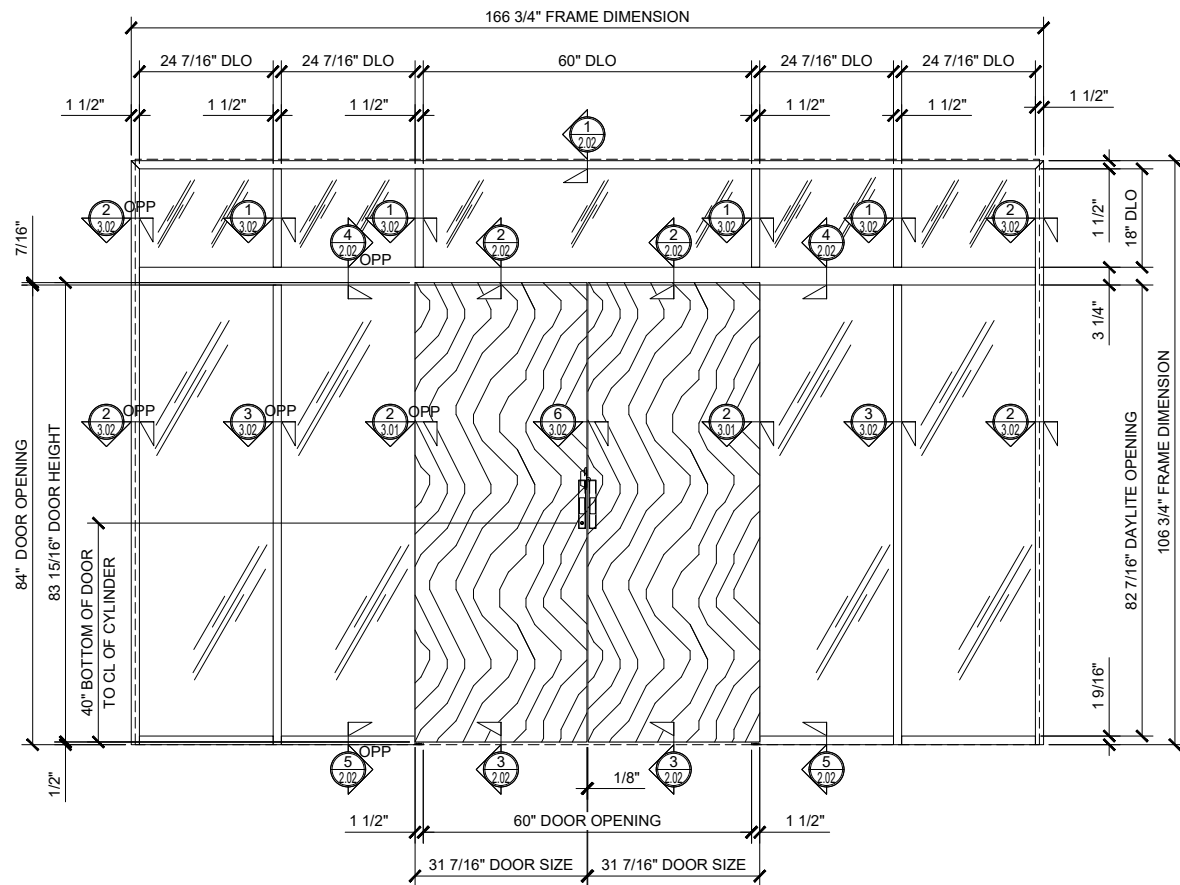

③ BI-PART SLIDER WITH TRANSOM AND SINGLE SIDELITES (CLOSED)

ARCH REF: NONE 3/4"=1'-0"

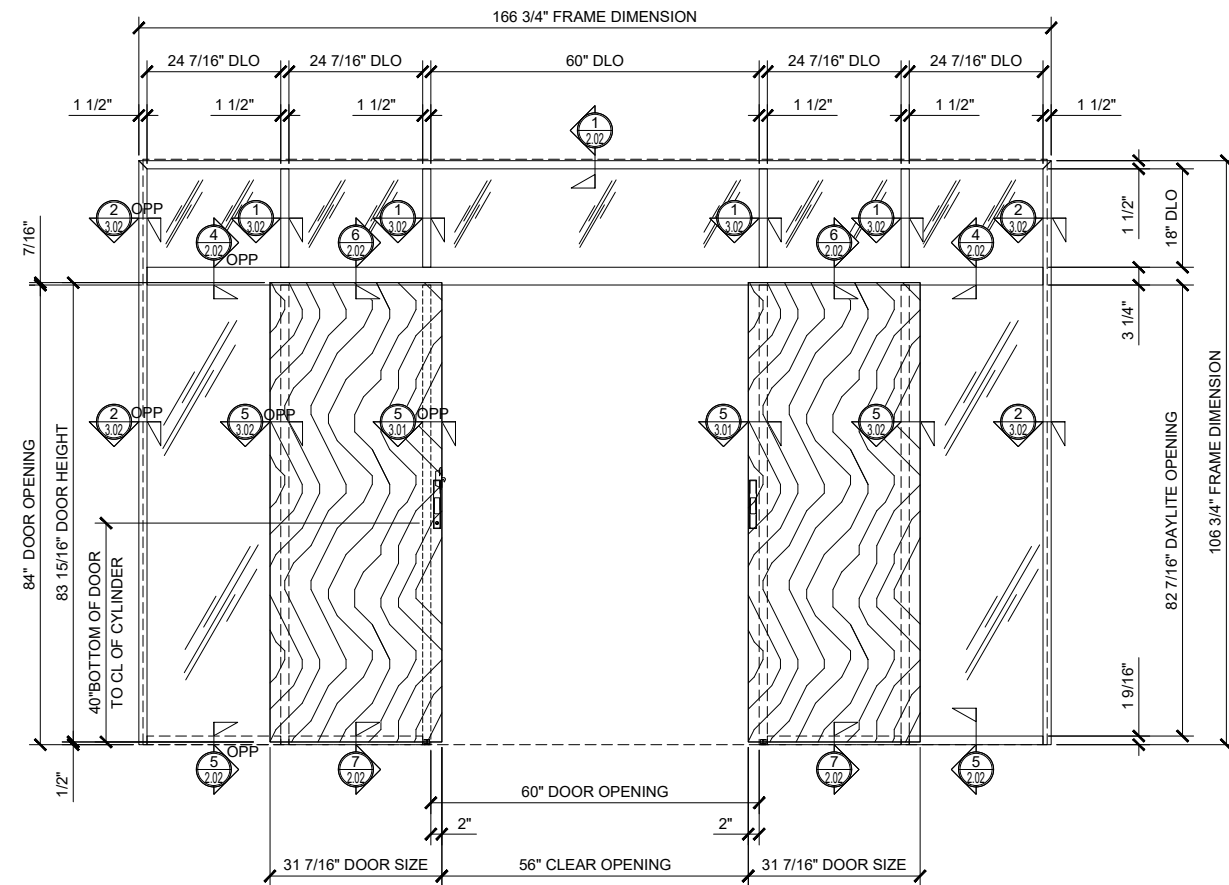

④ BI-PART SLIDER WITH TRANSOM AND SINGLE SIDELITES (OPEN)

ARCH REF: NONE 3/4"=1'-0"

Revisions By:



C.R. LAURENCE CO. ARCHITECTURAL PRODUCTS
 2503 E. Vernon Avenue, Los Angeles, CA 90058-1897
 PH: (800)-471-6144 FX: (800)-587-7261 www.crlurence.com

Description:

CRL 487-1.5 OFFICE
 PARTITION SYSTEM SLIDERS
 WOOD DOOR SLIDERS

Drawn By: AAD

Date: 3/7/17

Scale: AS NOTED

File Name:
 CRL 487-Series Office Partition
 System Sliders.dwg

Sheet



SERIES 487 OFFICE PARTITION SYSTEM
SINGLE SLIDING DOOR W/ REGULAR SIDELITE AND SINGLE SLIDER SIDELITE, W/ AND W/O TRANSOM
SHOWN WITH OPTIONAL CRL WOOD FLUSH DOOR

Revisions By:

C.R. LAURENCE CO. ARCHITECTURAL PRODUCTS
 2503 E. Vernon Avenue, Los Angeles, CA 90058-1897
 PH: (800)-471-6144 FAX: 800-587-7261 www.crlaurence.com



Description:
 CRL 487-1.5 OFFICE
 PARTITION SYSTEM SLIDERS
 WOOD DOOR SLIDERS

Drawn By: AAD
 Date: 3/7/17
 Scale: AS NOTED
 File Name:
 CRL 487-Series Office Partition
 System Sliders.dwg
 Sheet

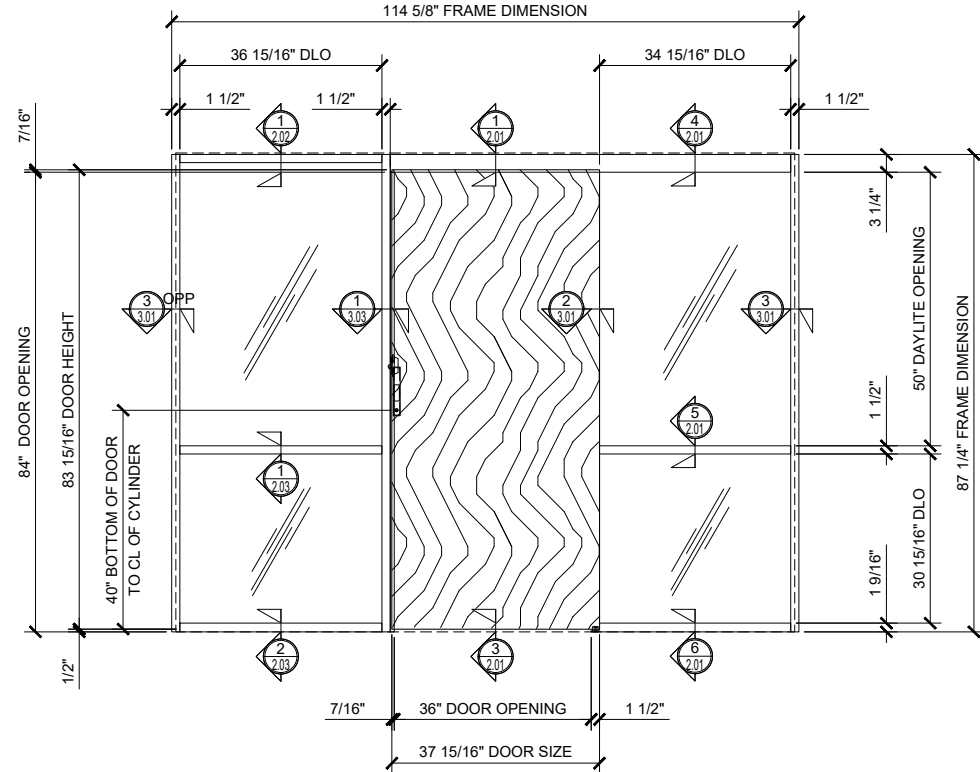

① SINGLE SLIDER WITH SINGLE SIDELITE (CLOSED)

ARCH REF: NONE 3/4"=1'-0"

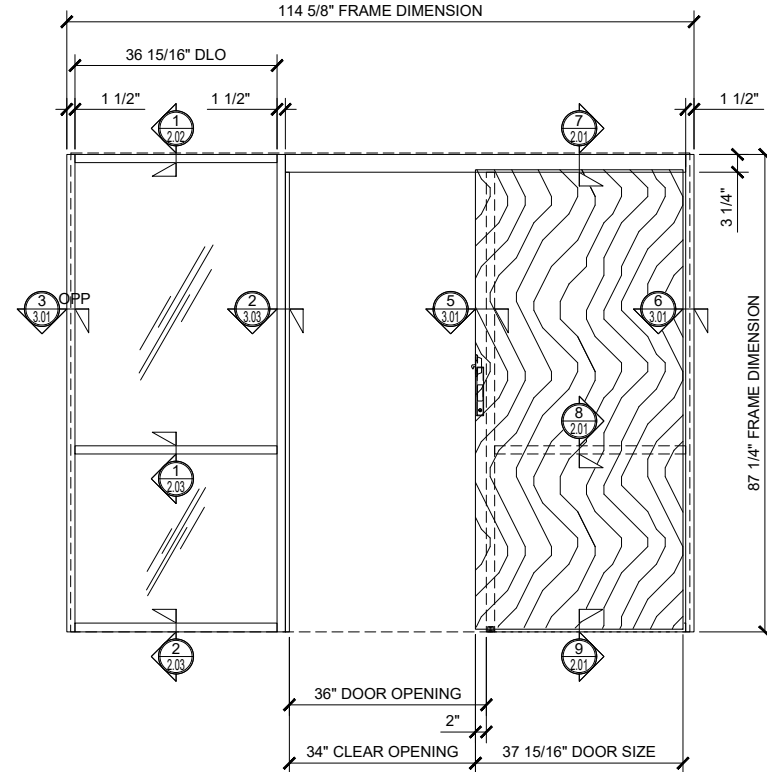

② SINGLE SLIDER WITH SINGLE SIDELITE (OPEN)

ARCH REF: NONE 3/4"=1'-0"

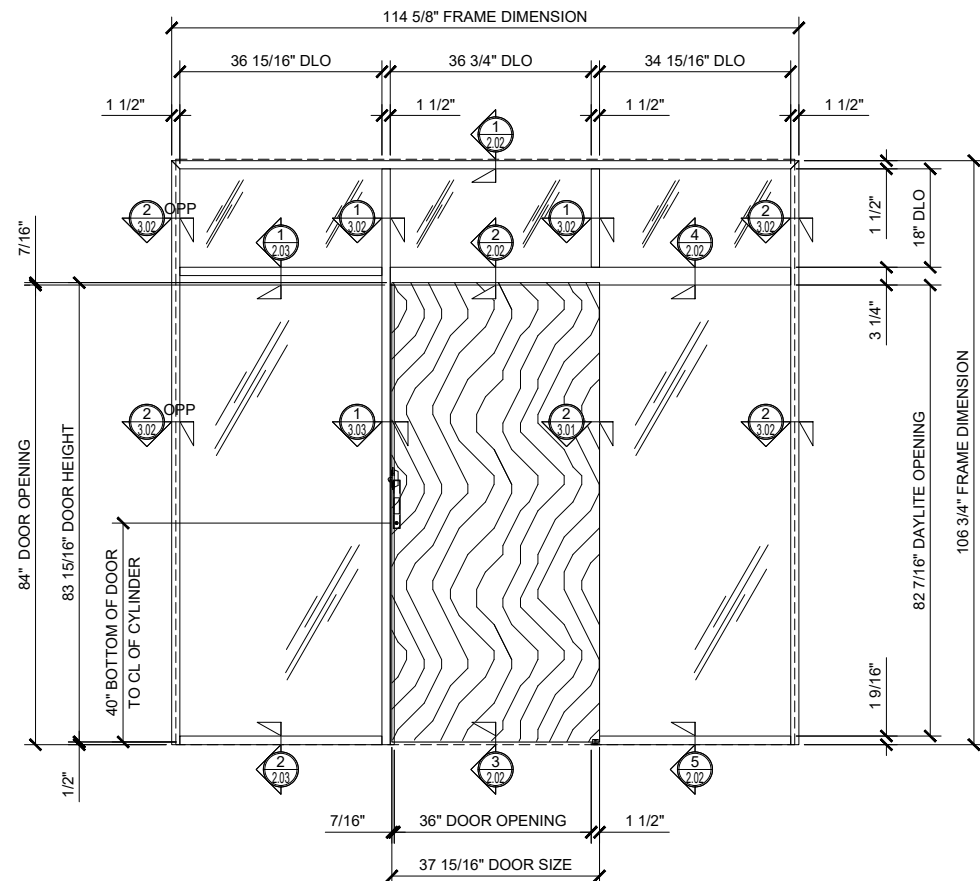

③ SINGLE SLIDER WITH TRANSOM AND SINGLE SIDELITE (CLOSED)

ARCH REF: NONE 3/4"=1'-0"

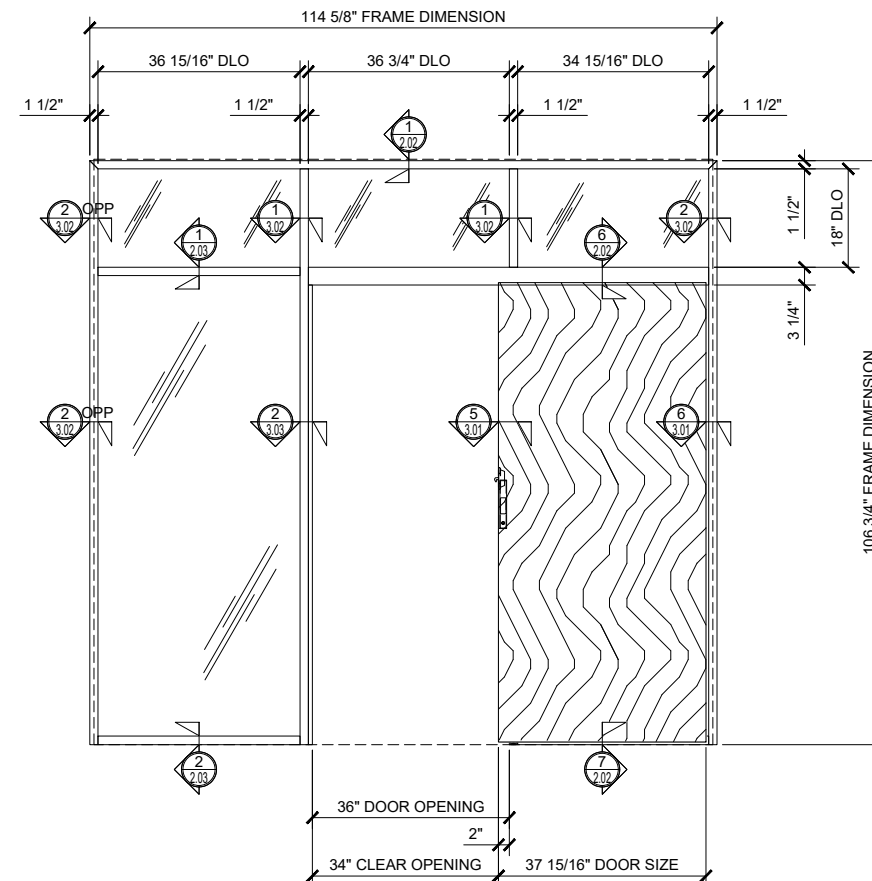

④ SINGLE SLIDER WITH TRANSOM AND SINGLE SIDELITE (OPEN)

ARCH REF: NONE 3/4"=1'-0"



SERIES 487 OFFICE PARTITION SYSTEM
SINGLE SLIDING DOOR W/ REGULAR SIDELITE AND SLIDER SIDELITE-REGULAR SIDELITE, W/ AND W/O TRANSOM
SHOWN WITH OPTIONAL CRL WOOD FLUSH DOOR

Revisions By:

C.R. LAURENCE CO. ARCHITECTURAL PRODUCTS
 2503 E. Vernon Avenue, Los Angeles, CA 90058-1897
 PH: (800)-471-6144 FX: 800-587-7261 www.crlaurence.com



Description:
 CRL 487-1.5 OFFICE
 PARTITION SYSTEM SLIDERS
 WOOD DOOR SLIDERS

Drawn By: AAD
 Date: 3/7/17
 Scale: AS NOTED
 File Name:
 CRL 487-Series Office Partition
 System Sliders.dwg
 Sheet

1.08

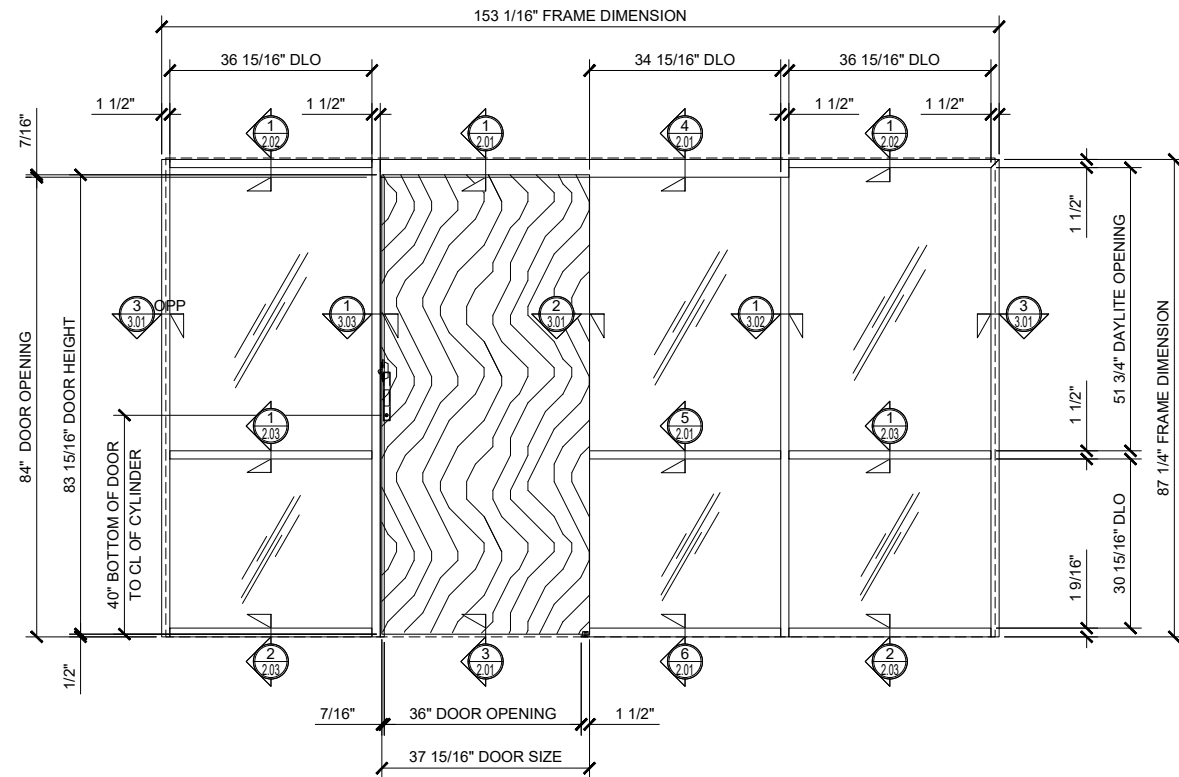

① SINGLE SLIDER WITH DOUBLE SIDELITE (CLOSED)

ARCH REF: NONE 3/4"=1'-0"

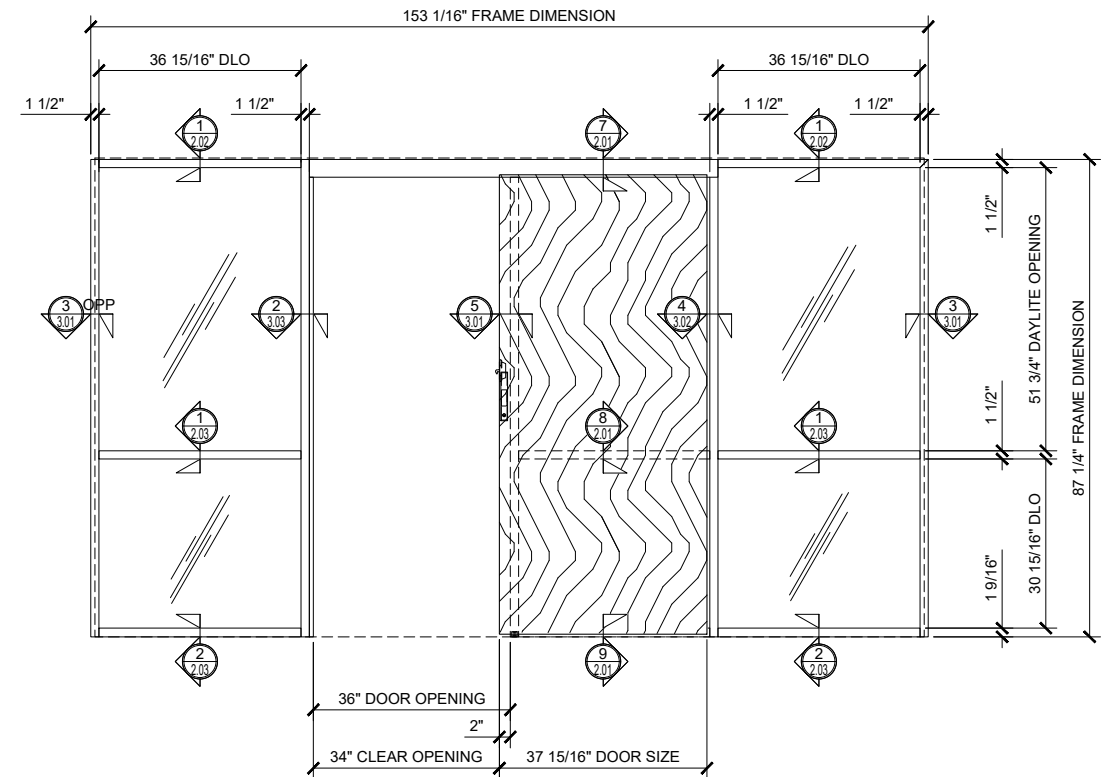

② SINGLE SLIDER WITH DOUBLE SIDELITE (OPEN)

ARCH REF: NONE 3/4"=1'-0"

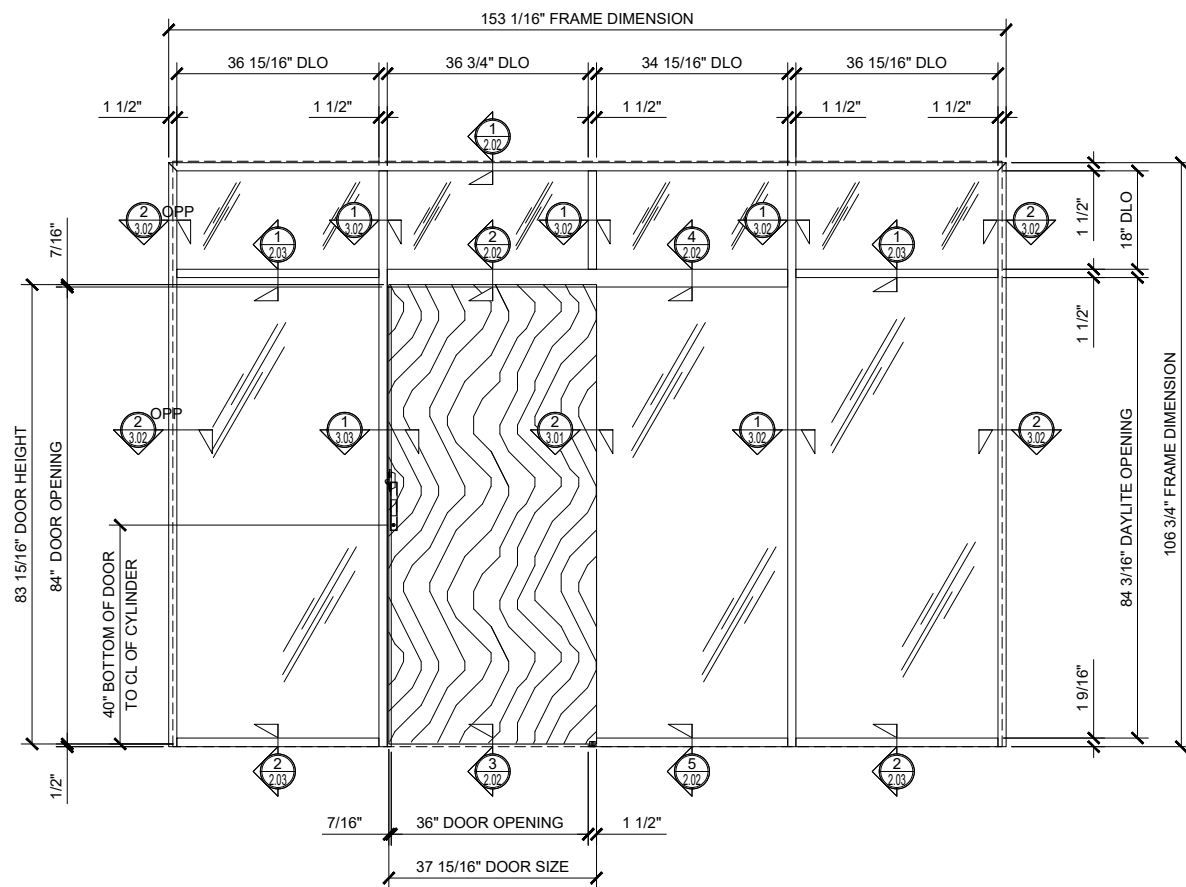

③ SINGLE SLIDER WITH TRANSOM AND DOUBLE SIDELITE (CLOSED)

ARCH REF: NONE 3/4"=1'-0"

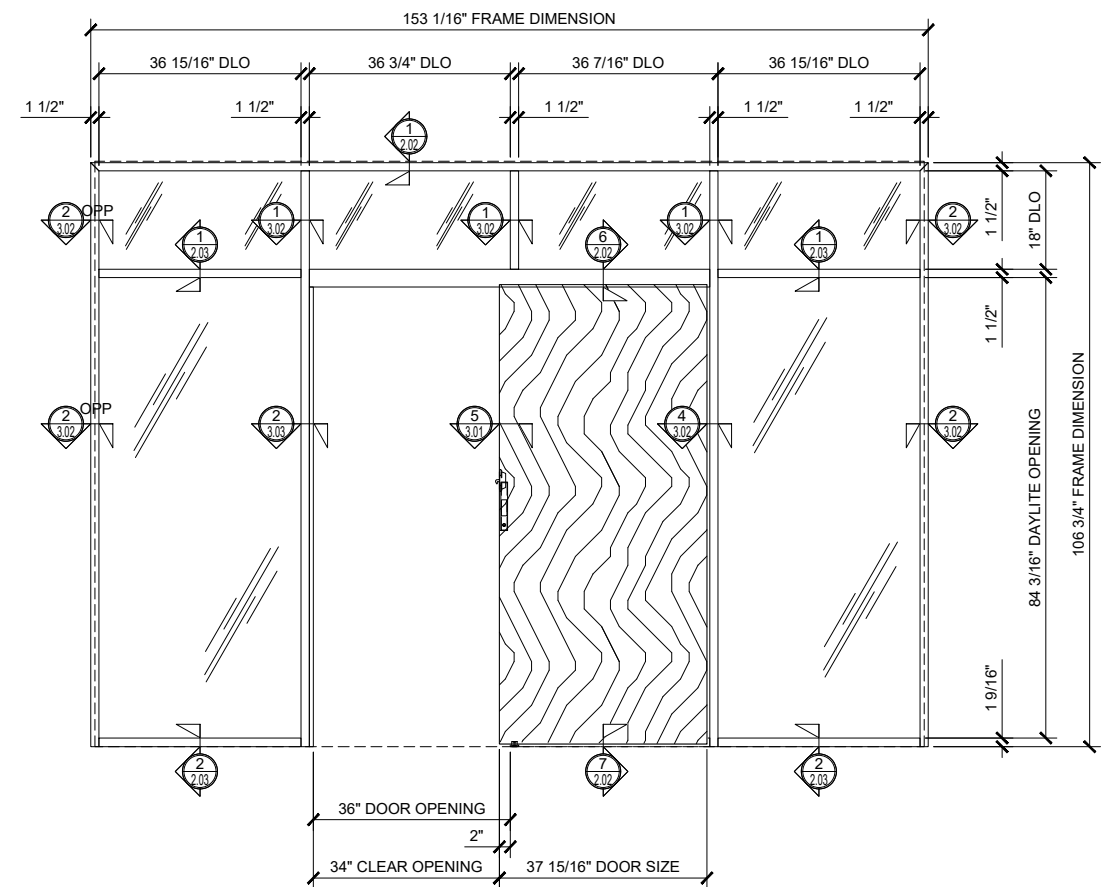

④ SINGLE SLIDER WITH TRANSOM AND DOUBLE SIDELITE (OPEN)

ARCH REF: NONE 3/4"=1'-0"



SERIES 487 OFFICE PARTITION SYSTEM
SINGLE SLIDING DOOR W/ REGULAR SIDELITE AND DUAL SLIDER SIDELITES, W/ AND W/O TRANSOM
SHOWN WITH OPTIONAL CRL WOOD FLUSH DOOR

Revisions By:

C.R. LAURENCE CO. ARCHITECTURAL PRODUCTS
 2503 E. Vernon Avenue, Los Angeles, CA 90058-1897
 PH: (800)-471-6144 FX: 800-587-7501 www.crlaurence.com



Description:
 CRL 487-1.5 OFFICE
 PARTITION SYSTEM SLIDERS
 WOOD DOOR SLIDERS

Drawn By: AAD
 Date: 3/7/17
 Scale: AS NOTED
 File Name:
 CRL 487-Series Office Partition
 System Sliders.dwg
 Sheet

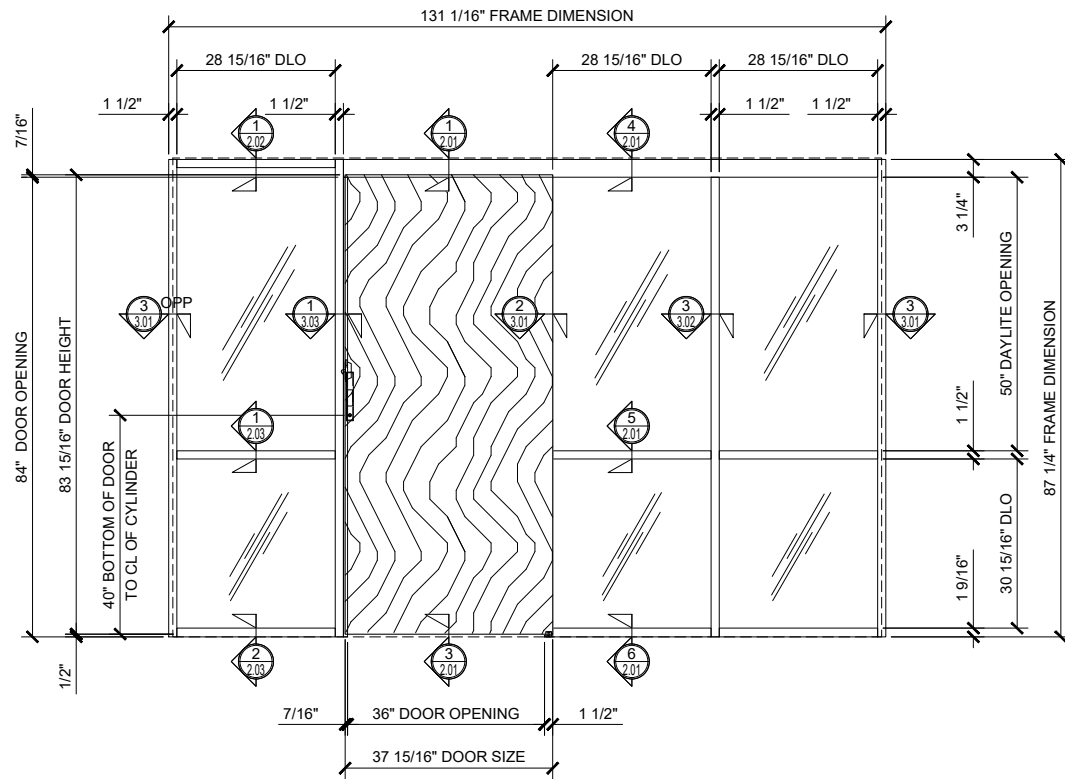

1 SINGLE SLIDER WITH DOUBLE SIDELITE (CLOSED)

ARCH REF: NONE 3/4"=1'-0"

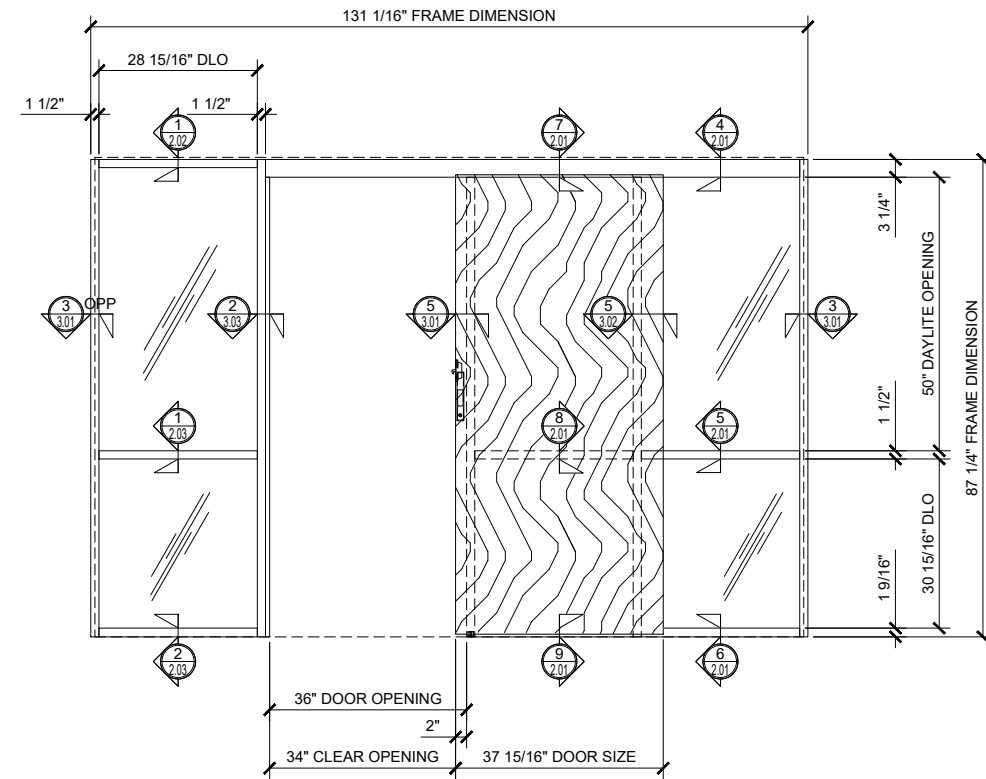

2 SINGLE SLIDER WITH DOUBLE SIDELITE (OPEN)

ARCH REF: NONE 3/4"=1'-0"

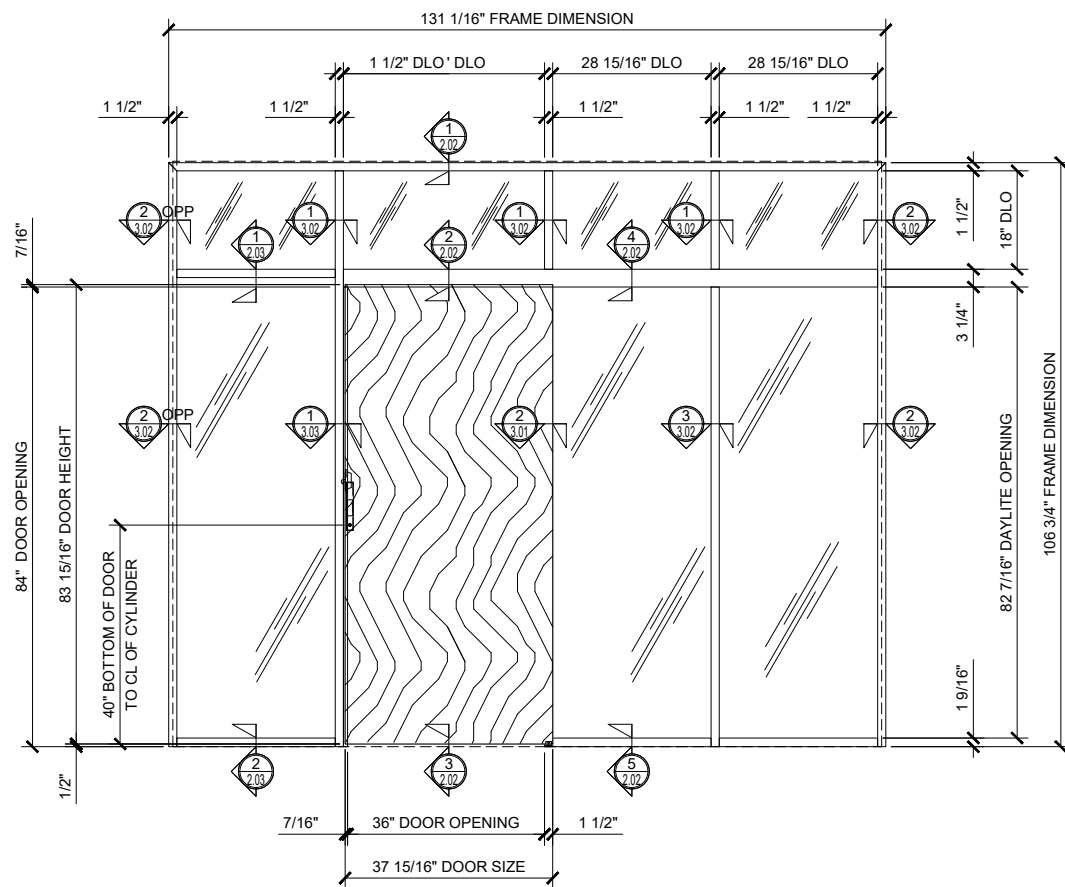

3 SINGLE SLIDER WITH TRANSOM AND DOUBLE SIDELITE (CLOSED)

ARCH REF: NONE 3/4"=1'-0"

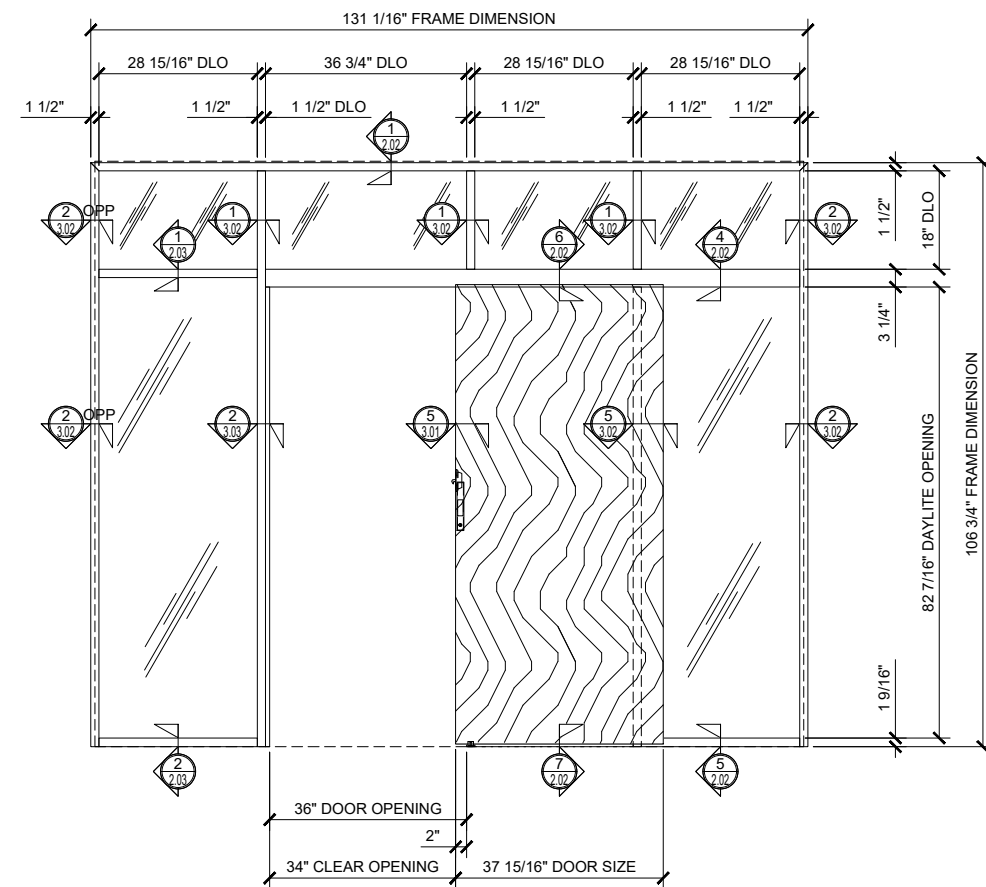

4 SINGLE SLIDER WITH TRANSOM AND DOUBLE SIDELITE (OPEN)

ARCH REF: NONE 3/4"=1'-0"

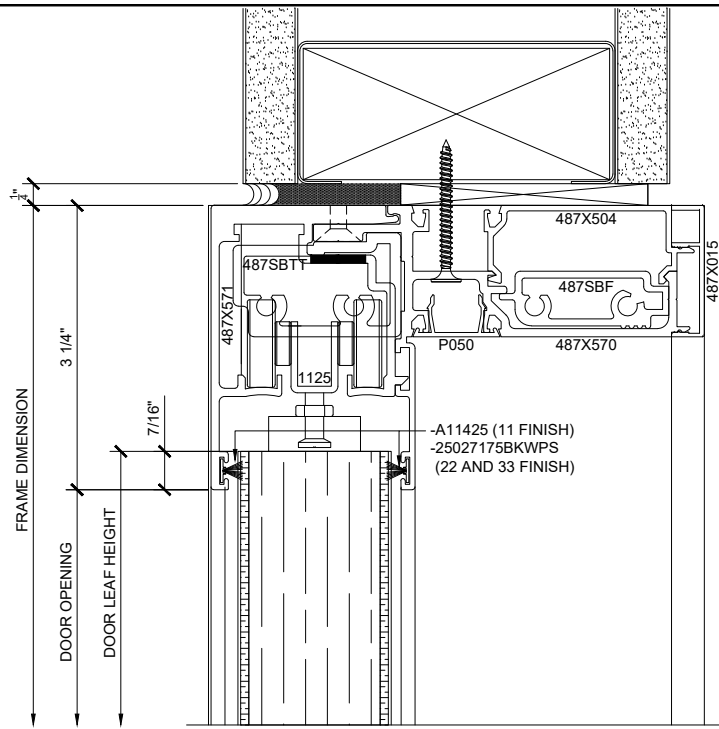

1 HEAD DETAIL AT SLIDER DOOR OPENING
ARCH REF: 1'-0"=1'-0"

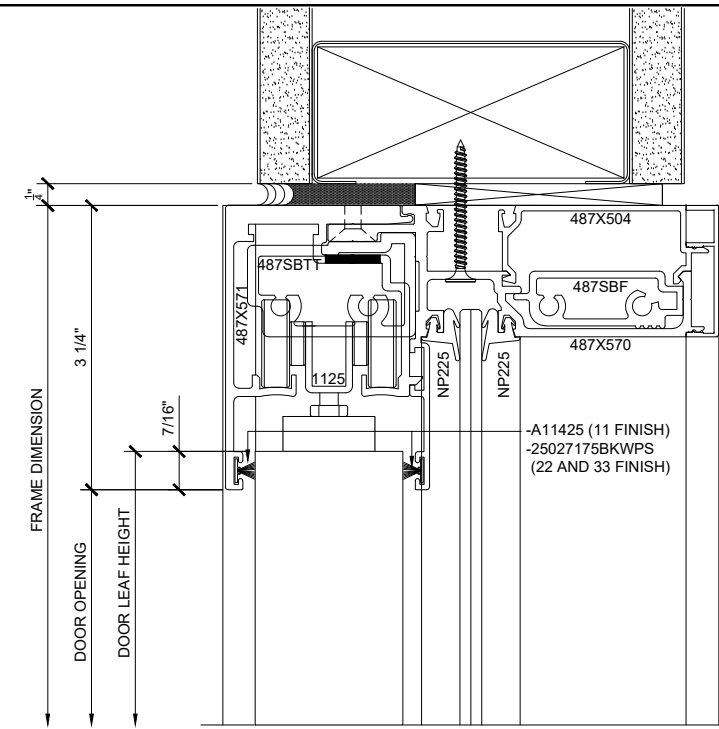

4 HEAD DETAIL AT SLIDER SIDELITE (DOOR CLOSED)
ARCH REF: 1'-0"=1'-0"

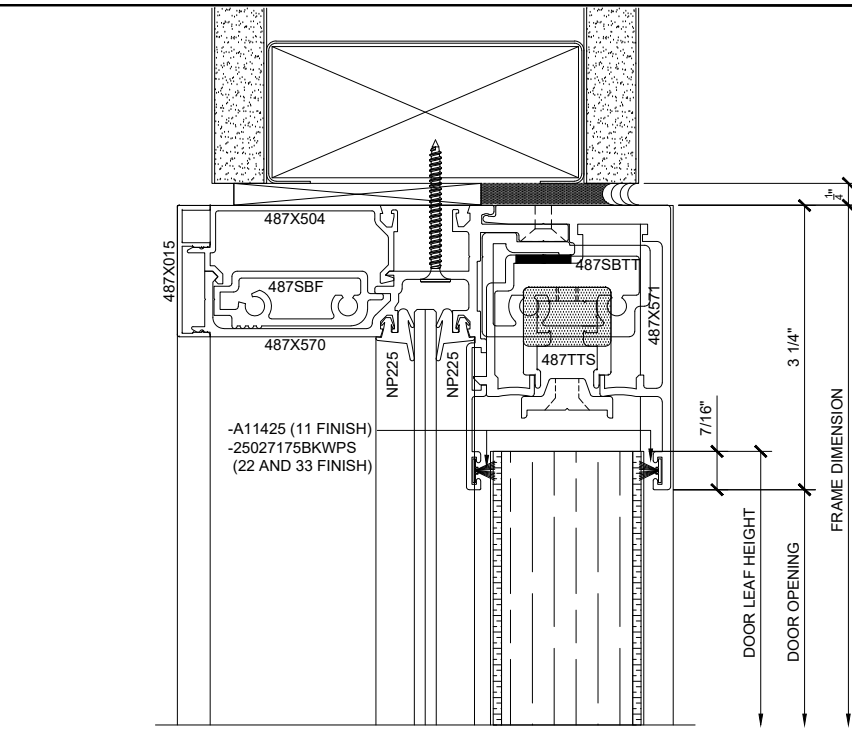

7 HEAD DETAIL AT SLIDER SIDELITE (DOOR OPEN)
ARCH REF: 1'-0"=1'-0"

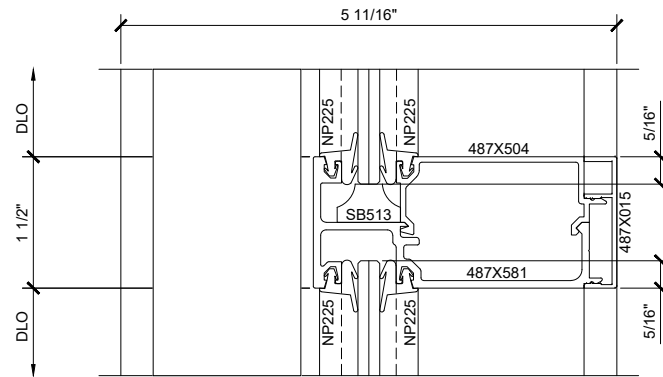

5 MUNTIN AT SLIDER SIDELITE (DOOR CLOSED)
ARCH REF: 1'-0"=1'-0"

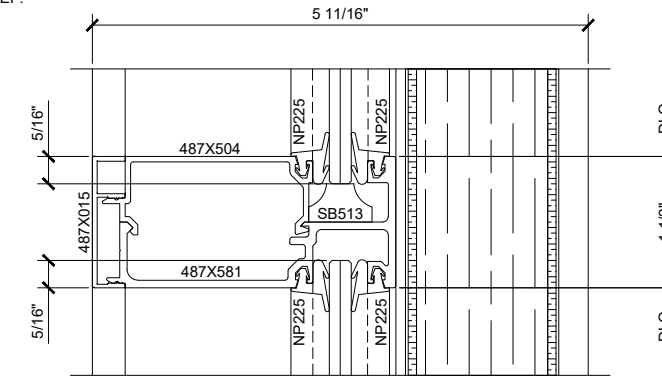

8 MUNTIN AT SLIDER SIDELITE (DOOR OPEN)
ARCH REF: 1'-0"=1'-0"

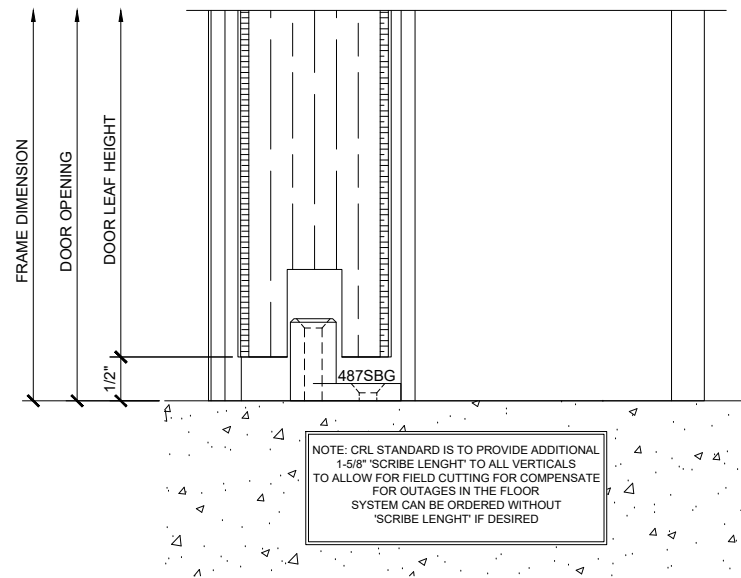

3 SILL AT SLIDER DOOR OPENING
ARCH REF: 1'-0"=1'-0"

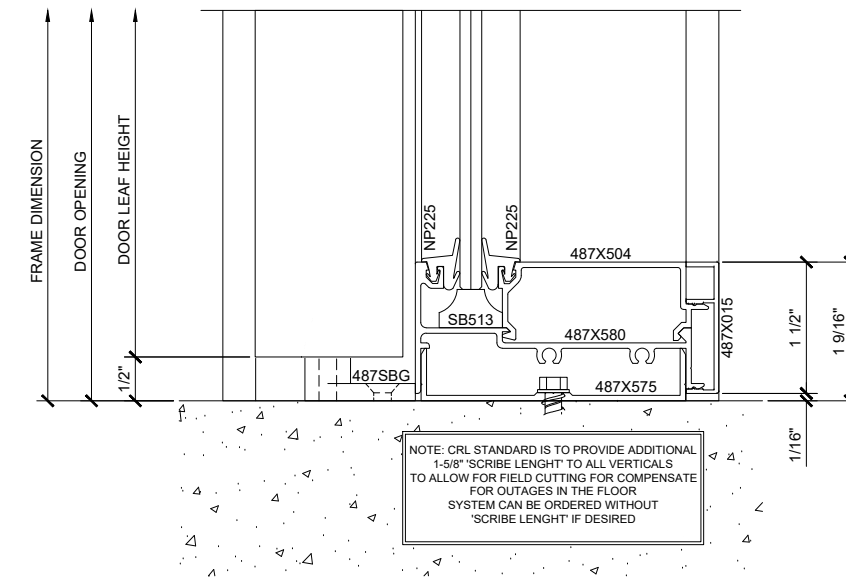

6 SILL AT SLIDER SIDELITE (DOOR CLOSED)
ARCH REF: 1'-0"=1'-0"

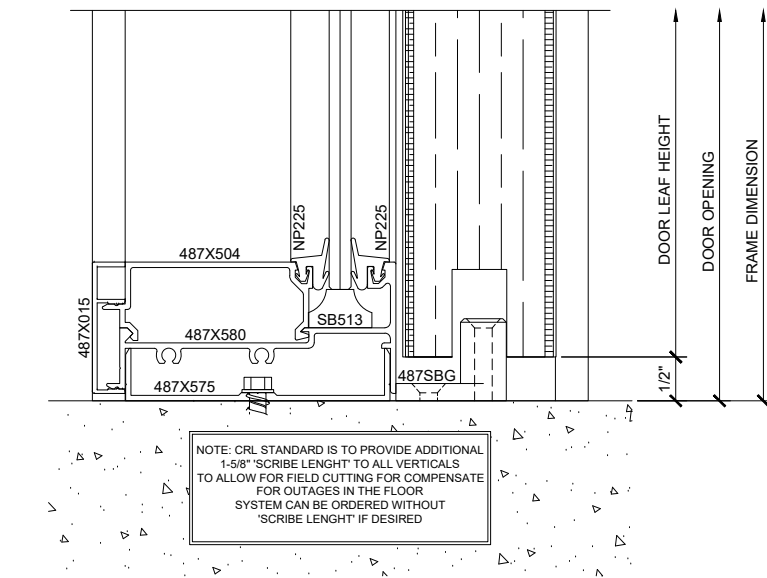

9 SILL AT SLIDER SIDELITE (DOOR OPEN)
ARCH REF: 1'-0"=1'-0"

Revisions By:



C.R. LAURENCE CO. ARCHITECTURAL PRODUCTS
2503 E. Vermont Avenue, Los Angeles, CA 90058-1897
PH: (800)-471-6144 FAX: (800)-587-7261 www.crlaurence.com

Discussion:

CRL 487-1.5 OFFICE
PARTITION SYSTEM SLIDERS
WOOD DOOR SLIDERS

Drawn By: AAD

Date: 3/7/17

Scale: AS NOTED

File Name:
CRL 487-Series Office Partition
System Sliders.dwg

Sheet

Revisions By:

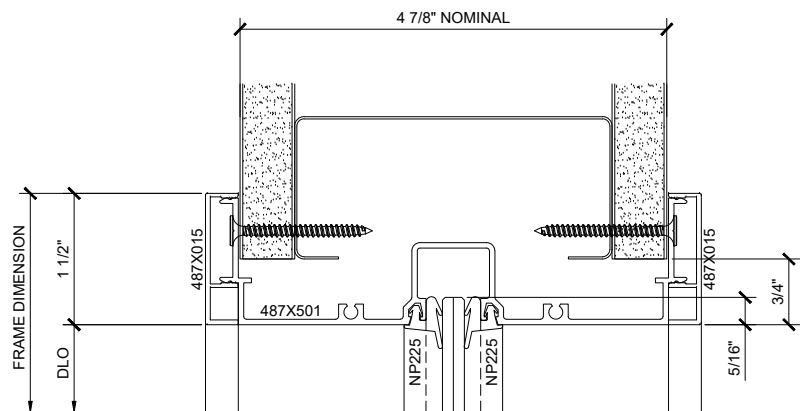

① SERIES 487 OPS TYP HEAD DETAIL AT INT. VERTICAL

ARCH REF: 1'-0"=1'-0"

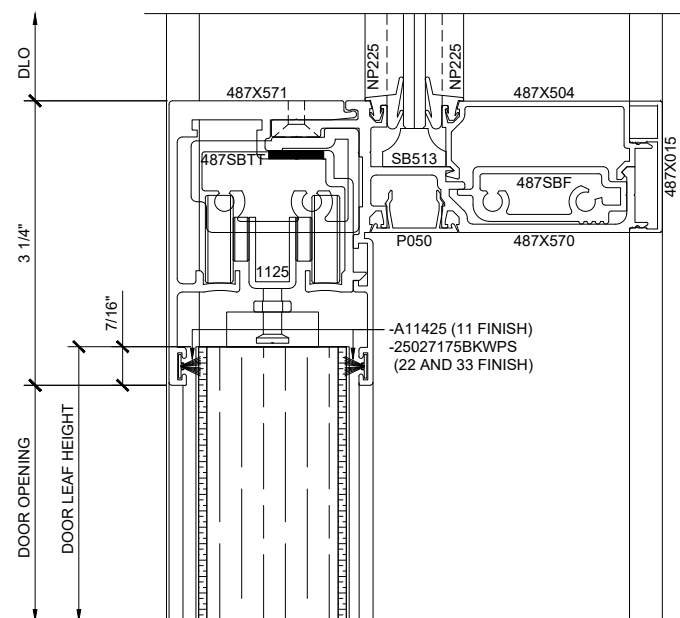

② TRANSOM DETAIL AT SLIDER DOOR OPENING

ARCH REF: 1'-0"=1'-0"

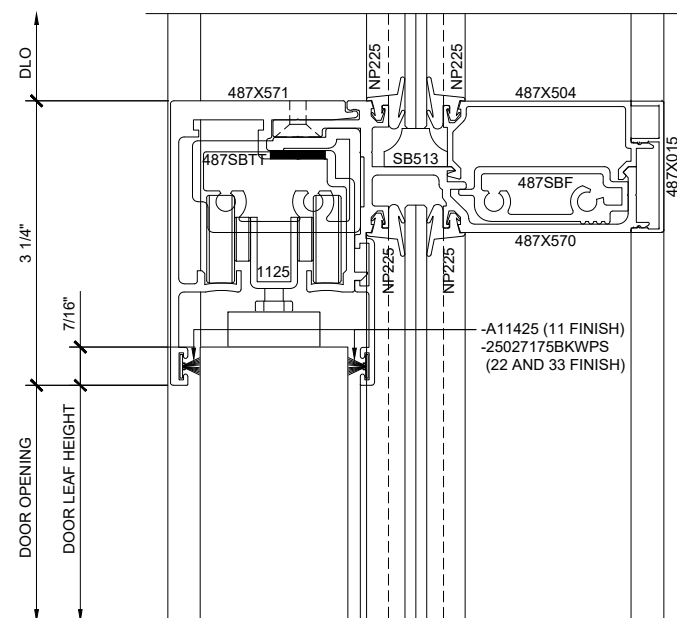

④ TRANSOM DETAIL AT SLIDER SIDELITE (DOOR CLOSED)

ARCH REF: 1'-0"=1'-0"

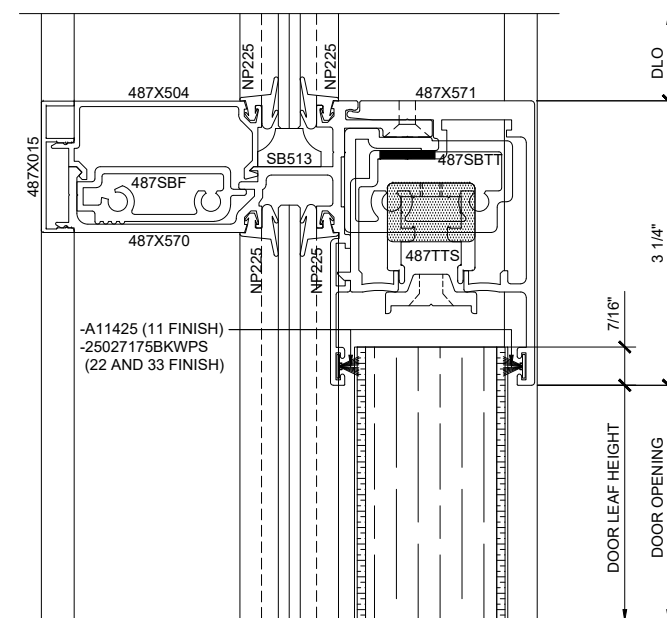

⑥ TRANSOM DETAIL AT SLIDER DOOR SIDELITE (DOOR OPEN)

ARCH REF: 1'-0"=1'-0"

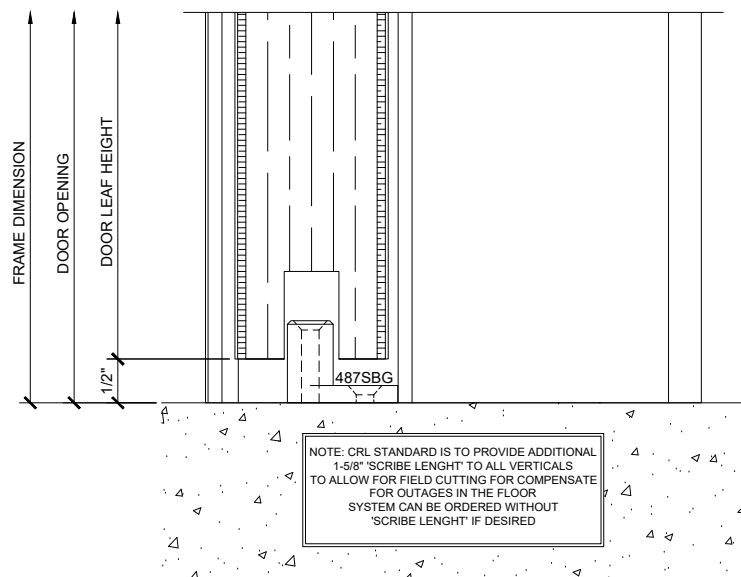

③ SILL AT SLIDER DOOR OPENING

ARCH REF: 1'-0"=1'-0"

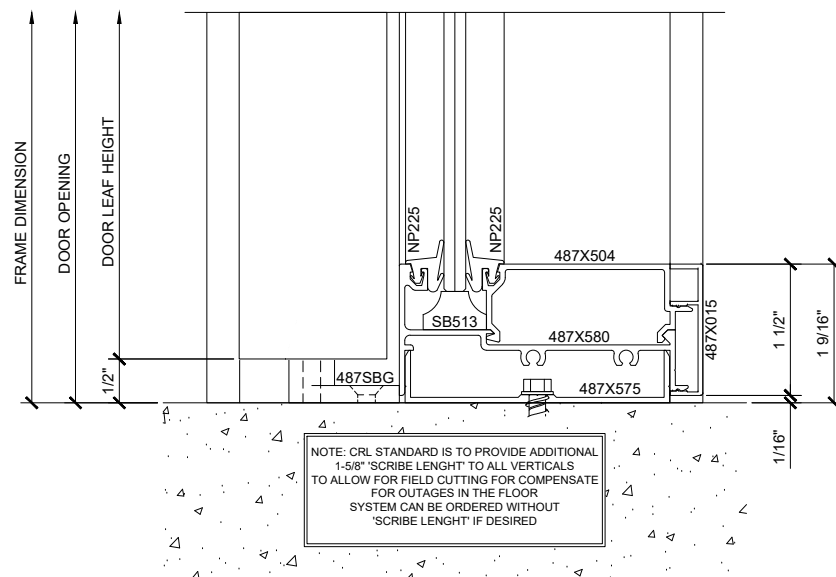

⑤ SILL AT SLIDER SIDELITE (DOOR CLOSED)

ARCH REF: 1'-0"=1'-0"

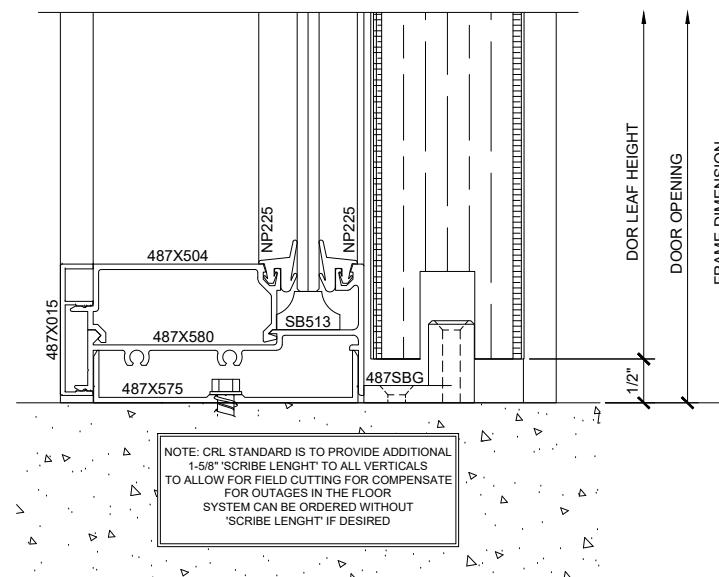

⑦ SILL AT SLIDER DOOR SIDELITE (DOOR OPEN)

ARCH REF: 1'-0"=1'-0"

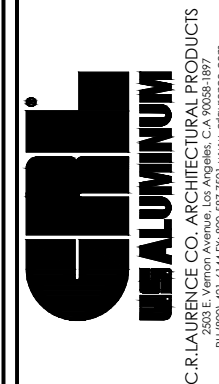

Description:

CRL 487-1.5 OFFICE
PARTITION SYSTEM SLIDERS
WOOD DOOR SLIDERS

Drawn By: AAD

Date: 3/7/17

Scale: AS NOTED

File Name:
CRL 487-Series Office Partition
System Sliders.dwg

Sheet

2.02

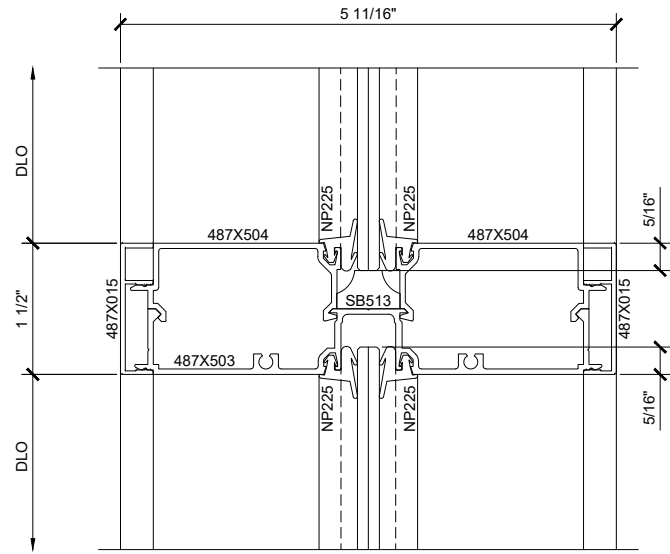

① SERIES 487 OPS TYP HORIZONTAL DETAIL
 ARCH REF: 1'-0"=1'-0"

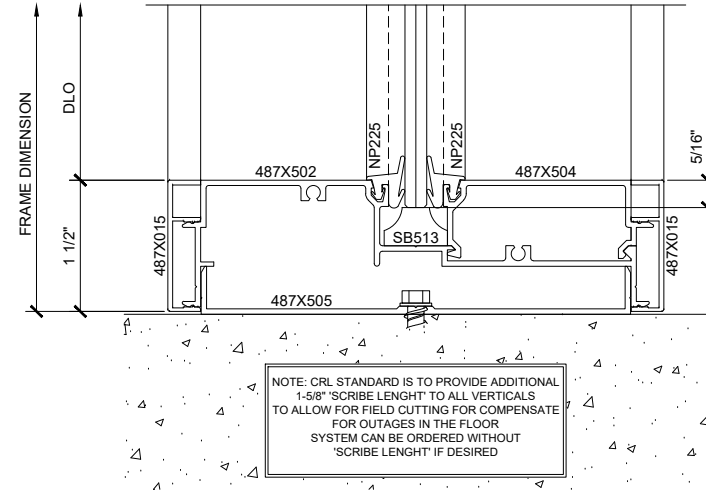

NOTE: CRL STANDARD IS TO PROVIDE ADDITIONAL 1-5/8" SCRIBE LENGTH TO ALL VERTICALS TO ALLOW FOR FIELD CUTTING FOR COMPENSATE FOR OUTAGES IN THE FLOOR SYSTEM CAN BE ORDERED WITHOUT "SCRIBE LENGTH" IF DESIRED

② SERIES 487 OPS TYP SILL AT FLOOR DETAIL
 ARCH REF: 1'-0"=1'-0"

Revisions By:

CRL
ALUMINUM
 C.R. LAURENCE CO. ARCHITECTURAL PRODUCTS
 2503 E. Yermont Avenue, Los Angeles, CA 90058-1897
 PH: (800)-471-6144 FX: 800-587-7261 www.crlaurence.com

Description:
 CRL 487-1.5 OFFICE
 PARTITION SYSTEM SLIDERS
 WOOD DOOR SLIDERS

Drawn By: AAD
 Date: 3/7/17
 Scale: AS NOTED
 File Name:
 CRL 487-Series Office Partition
 System Sliders.dwg

Sheet

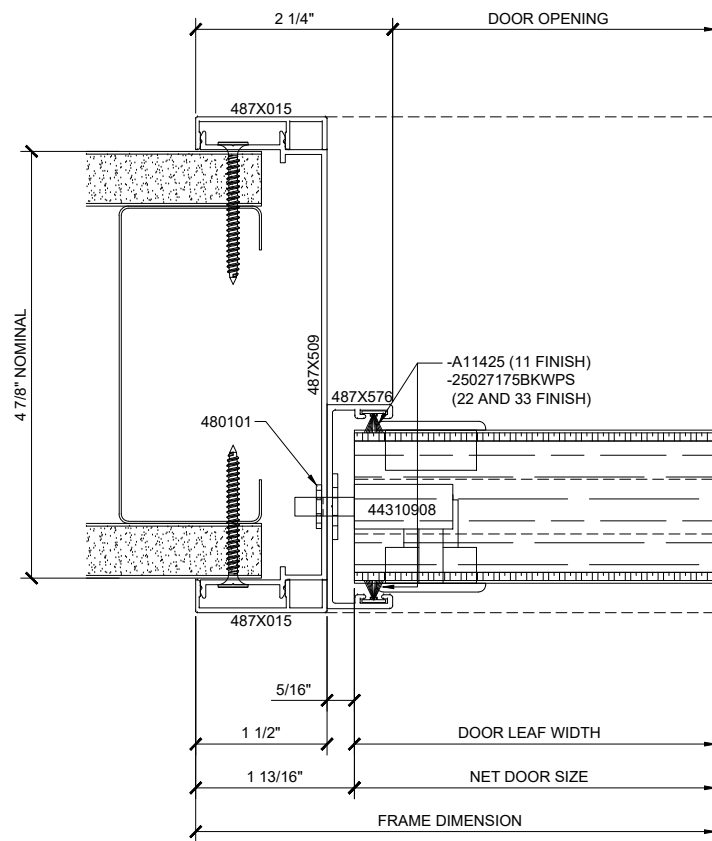

① SERIES 487 OPS INTEGRATED SLIDER STRIKE JAMB DETAIL (CLOSED)

ARCH REF: 1'-0"=1'-0"

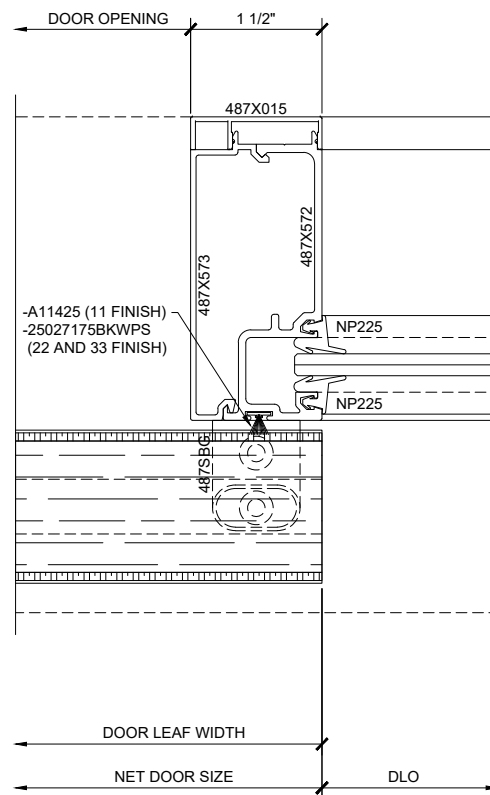

② SERIES 487 OPS INTEGRATED SLIDER INTERMEDIATE JAMB DETAIL (CLOSED)

ARCH REF: 1'-0"=1'-0"

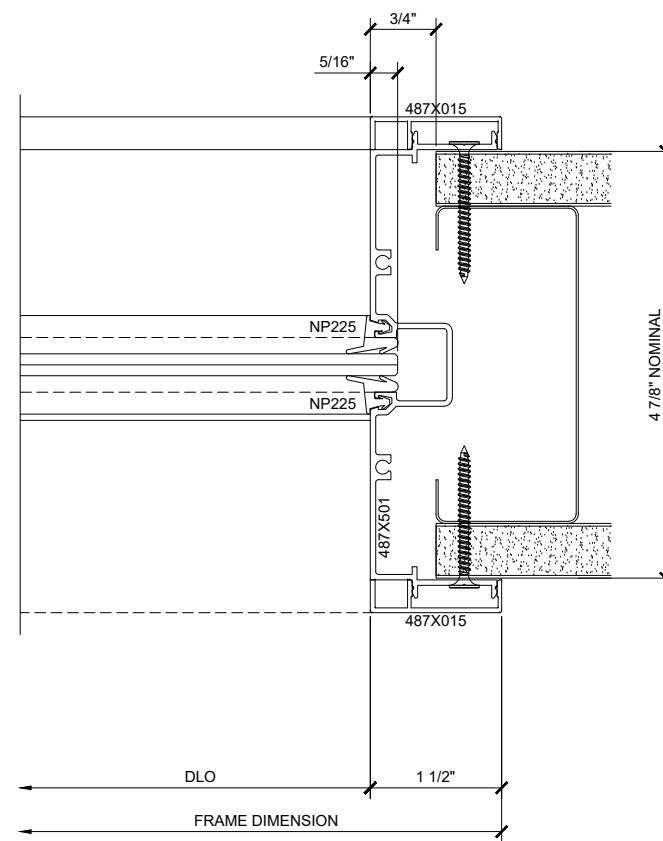

③ SERIES 487 OPS INTEGRATED SLIDER WALL JAMB DETAIL (CLOSED)

ARCH REF: 1'-0"=1'-0"

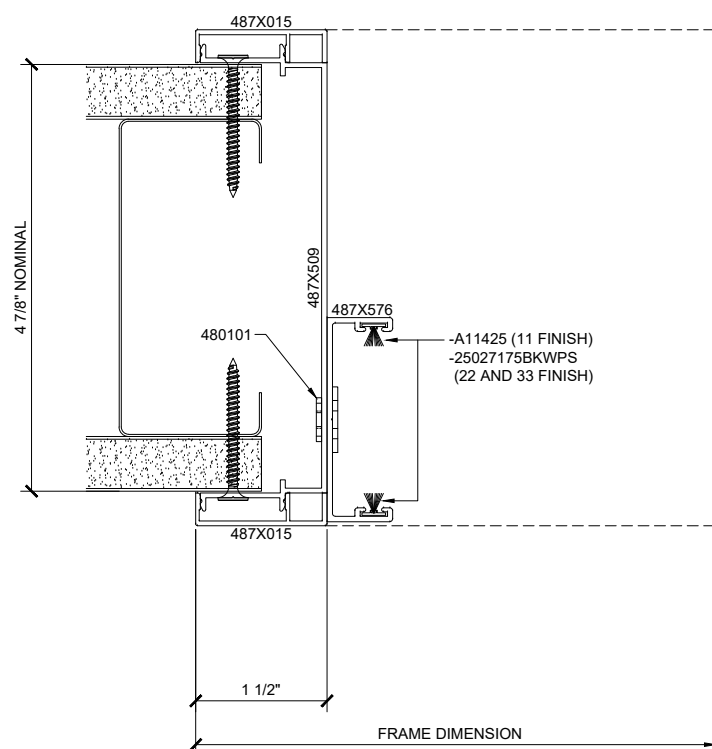

④ SERIES 487 OPS INTEGRATED SLIDER STRIKE JAMB DETAIL (OPEN)

ARCH REF: 1'-0"=1'-0"

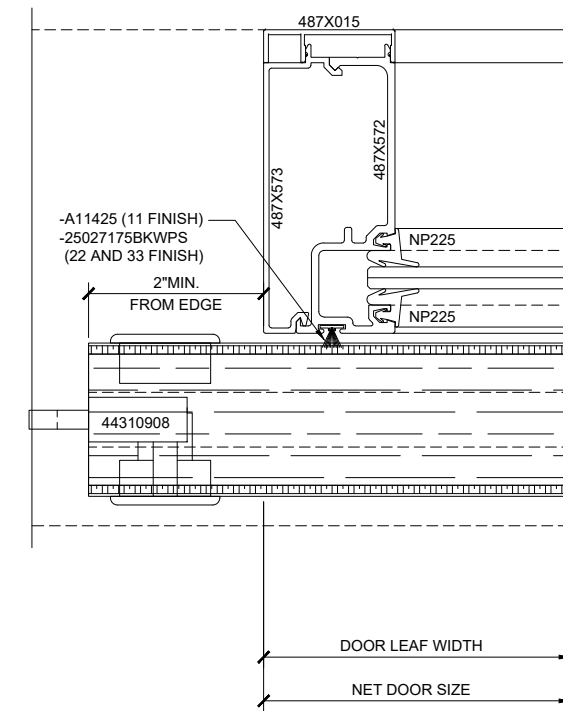

⑤ SERIES 487 OPS INTEGRATED SLIDER INTERMEDIATE JAMB DETAIL (OPEN)

ARCH REF: 1'-0"=1'-0"

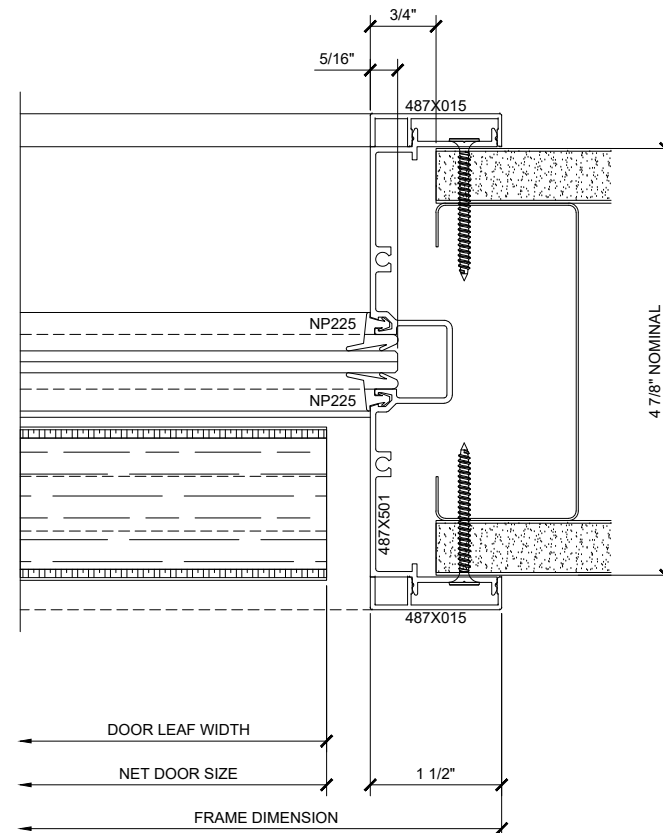

⑥ SERIES 487 OPS INTEGRATED SLIDER WALL JAMB DETAIL (OPEN)

ARCH REF: 1'-0"=1'-0"

Revisions By:



C.R. LAURENCE CO. ARCHITECTURAL PRODUCTS
2503 E. Vermont Avenue, Los Angeles, CA 90058-1897
PH (800)-421-6144 FX (800)-587-7261 www.crlaurence.com

Description:

CRL 487-1.5 OFFICE
PARTITION SYSTEM SLIDERS
WOOD DOOR SLIDERS

Drawn By: AAD

Date: 3/7/17

Scale: AS NOTED

File Name:
CRL 487-Series Office Partition
System Sliders.dwg

Sheet

3.01

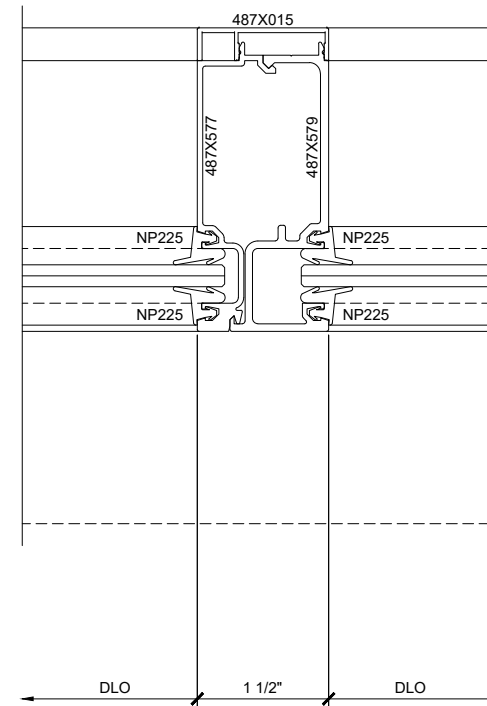
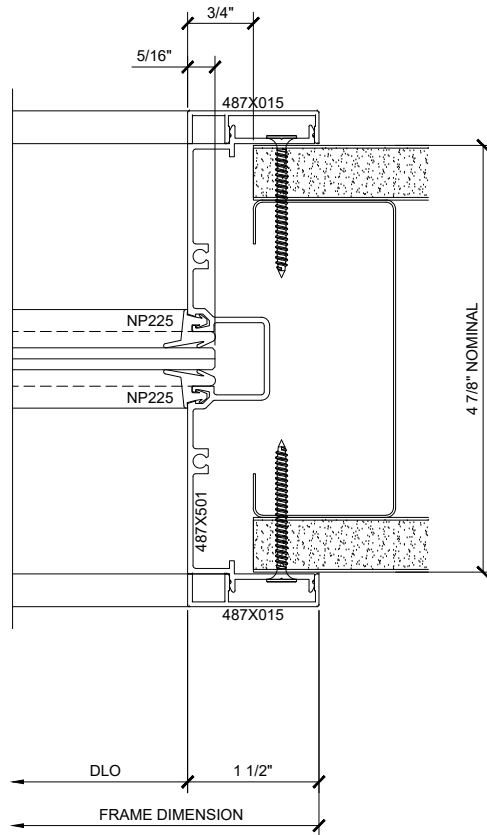
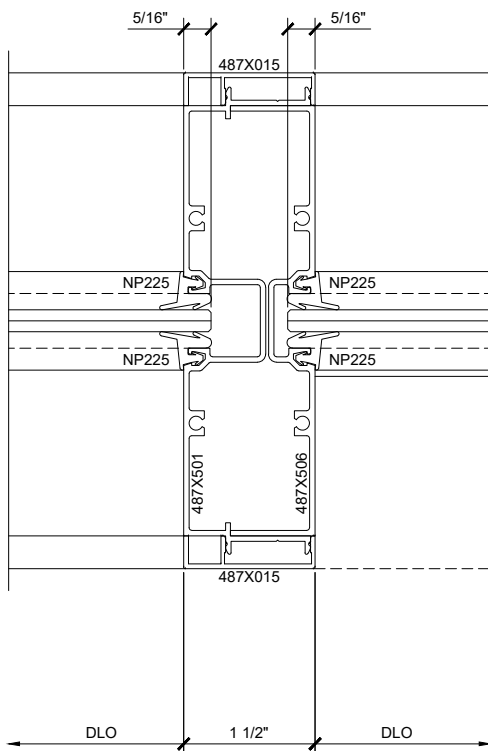

① SERIES 487 OPS INTEGRATED SLIDER
TRANSITION VERTICAL-SLIDER TO STANDARD (CLOSED)
ARCH REF: 1'-0"=1'-0"

② SERIES 487 OPS STANDARD JAMB DETAIL
ARCH REF: 1'-0"=1'-0"

③ SERIES 487 OPS INTEGRATED SLIDER
BY-PASS INTERMEDIATE VERTICAL DETAIL (CLOSED)
ARCH REF: 1'-0"=1'-0"

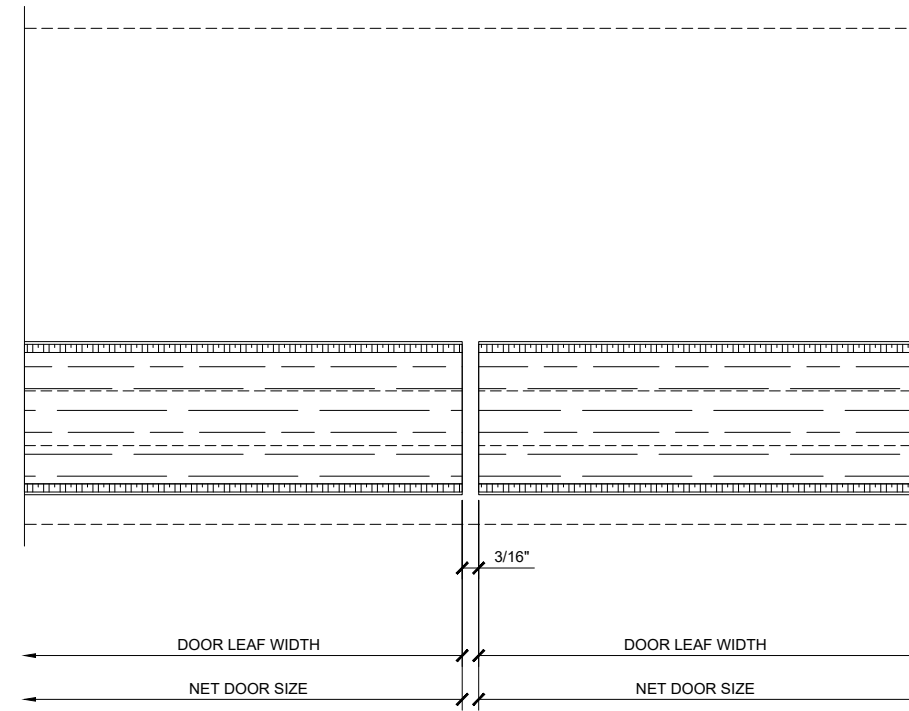
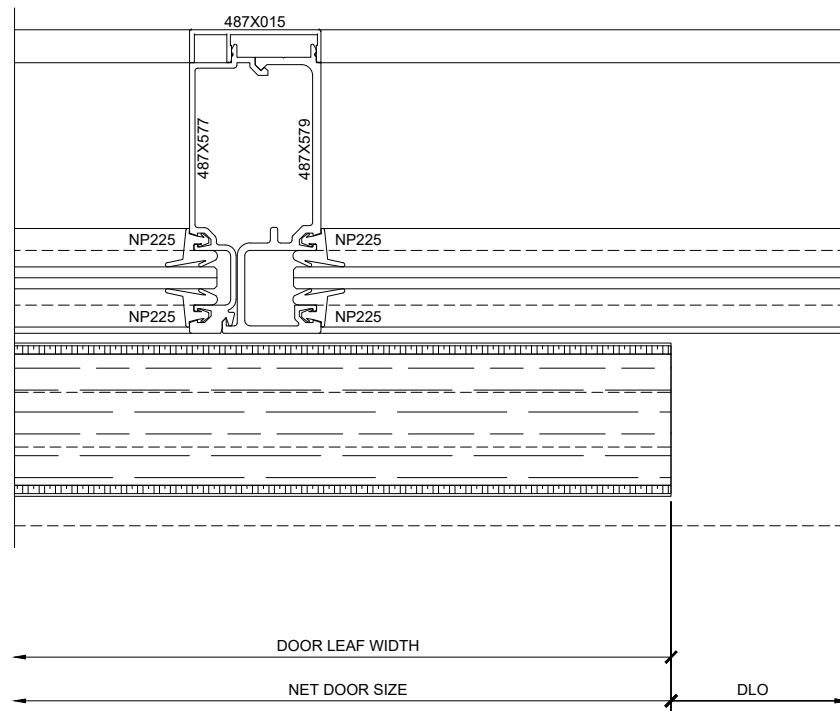
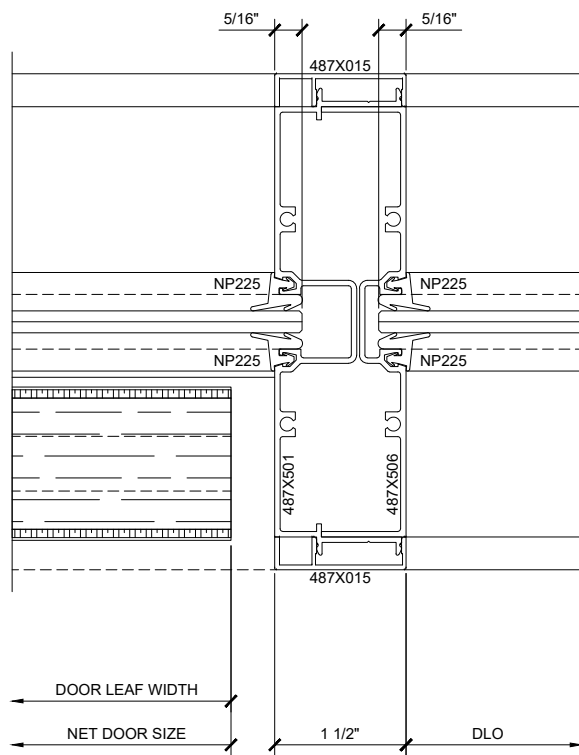

④ SERIES 487 OPS INTEGRATED SLIDER
TRANSITION VERTICAL-SLIDER TO STANDARD (OPEN)
ARCH REF: 1'-0"=1'-0"

⑤ SERIES 487 OPS INTEGRATED SLIDER
SHALLOW VERTICAL DETAIL (OPEN)
ARCH REF: 1'-0"=1'-0"

⑥ SERIES 487 OPS INTEGRATED SLIDER
MEETING STILES AT DOOR PAIR DETAIL (CLOSED)
ARCH REF: 1'-0"=1'-0"

Revisions By:



Discription:
CRL 487-1.5 OFFICE
PARTITION SYSTEM SLIDERS
WOOD DOOR SLIDERS

Drawn By: AAD
Date: 3/7/17
Scale: AS NOTED
File Name:
CRL 487-Series Office Partition
System Sliders.dwg

Sheet

3.02

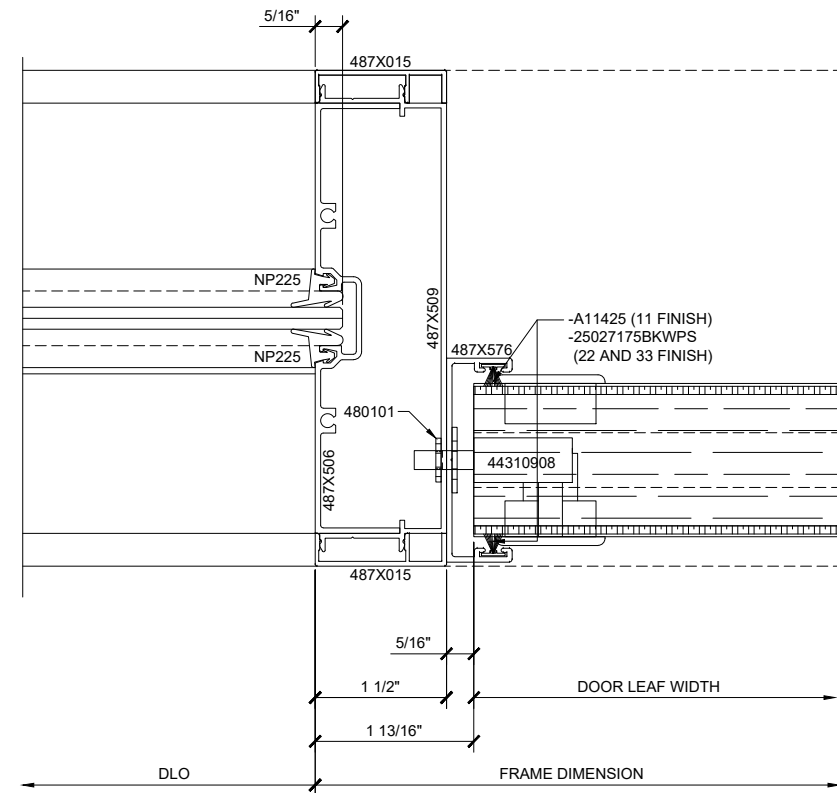

① SERIES 487 OPS INTEGRATED SLIDER
TRANSITION VERTICAL-STANDARD TO STRIKE JAMB (CLOSED)

ARCH REF: 1'-0"=1'-0"

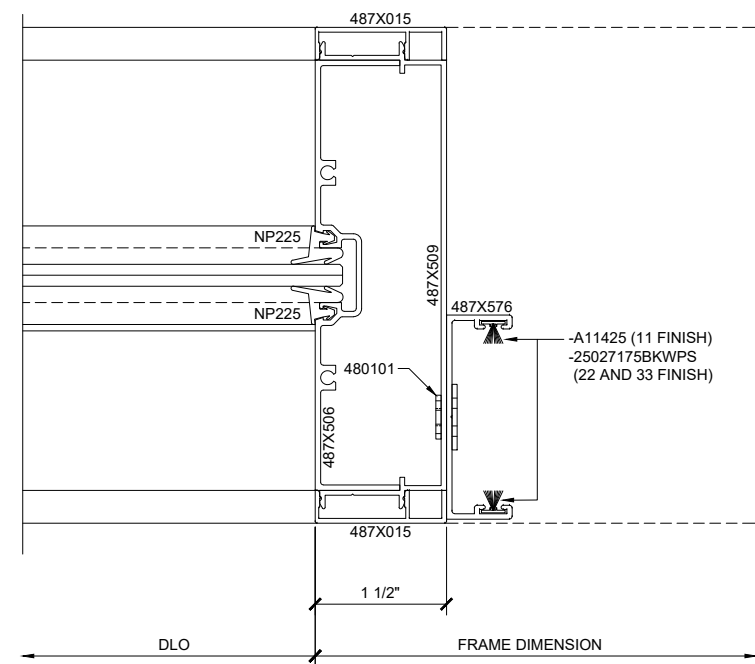

② SERIES 487 OPS INTEGRATED SLIDER
TRANSITION VERTICAL-STANDARD TO STRIKE JAMB (OPEN)

ARCH REF: 1'-0"=1'-0"

Revisions By:



C.R. LAURENCE CO. ARCHITECTURAL PRODUCTS
2503 E. Vernon Avenue, Los Angeles, CA 90058-1897
PH: (800)-421-6144 FAX: 800-587-7501 www.crlaurence.com

Discription:

CRL 487-1.5 OFFICE
PARTITION SYSTEM SLIDERS
WOOD DOOR SLIDERS

Drawn By: AAD

Date: 3/7/17

Scale: AS NOTED

File Name:
CRL 487-Series Office Partition
System Sliders.dwg

Sheet

3.03