

SIDE

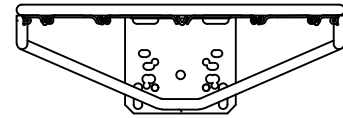

FRONT

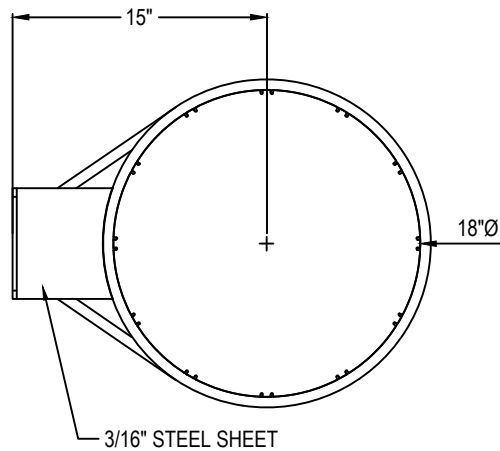

TOP

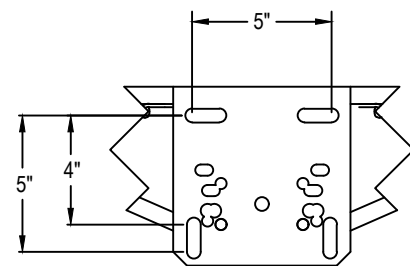

REAR (UNIVERSAL BACKPLATE)

Rim shall be constructed of an official size 5/8" diameter AISI 1018 cold drawn carbon steel ring with continuous wire formed netlocks to accept nylon net (included). Backplate shall be a minimum 3/16" thick. Rim shall be supported by a 1/2" diameter steel brace. Mounting hardware shall be included. Installation to be completed in accordance with manufacturer's instructions. Do not scale drawings. Rim shall carry a 1-year limited warranty, have an orange powder coated finish, be made in the USA and weigh approximately 12#.



PRODUCT SPECIFICATION

BA27 STANDARD FRONT MOUNT COMPETITION GOAL

REVISED 7/1/17