

FRONT

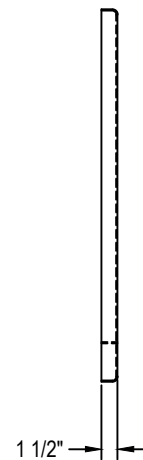

SIDE

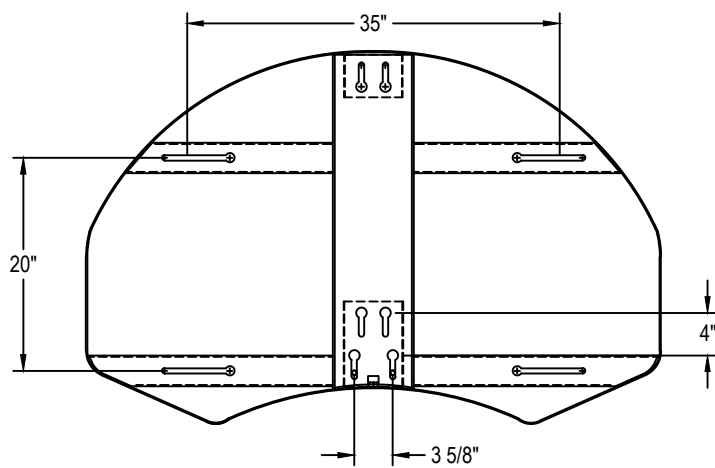

REAR

Backboard shall be 35" x 54" fan-shaped steel and be designed for rear mount rim applications. Skin shall be 12 ga. mild steel with 7 ga. and 10 ga. support structure. All skin edges shall be formed to create a 1 1/2" lip to add strength. Structure on the rear shall allow mounting to common 20" x 35" supports. The backboard shall be coated with a white polyester powder coated finish. Backboard shall carry a 5-year limited warranty. Installation to be completed in accordance to manufacturer's instructions. Do not scale drawings. Weigh approximatley 90#.



PRODUCT SPECIFICATION

BA485 RUFF PLAY™ REAR MOUNT STEEL PLAYGROUND BACKBOARD

REVISED 7/1/17