





Section 1 VEHICLE

Key blanks for automobiles, motorcycles, airplanes, boats, garden tractors, etc., designed and manufactured worldwide. The manufacturers are listed in alphabetical order with keys listed in numerical sequence where possible.

There are several symbols and suffixes used in this section. Below is a legend of their use.

	Transponder Key
	Electronic Key
	Special Key Machine Required
	Cloning Tool Required
-P	Plastic Head Key
-PC	Color Plastic Head Key
-P (-PC)	Available with Black or Color Plastic Head

ACURA

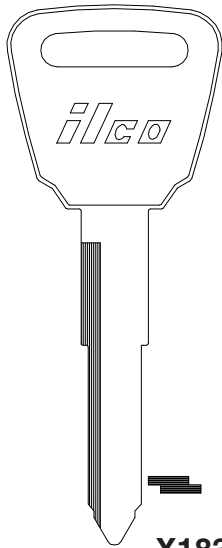

X183
HD92

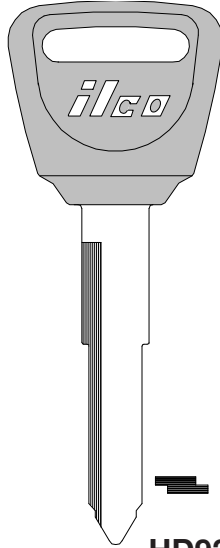

HD92-P
—

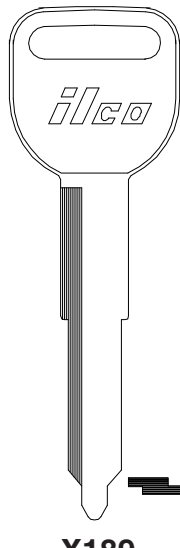

X189
HD93

VALET FOR X183 & HD92-P

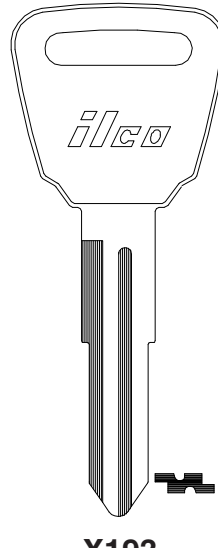

X193
HD96

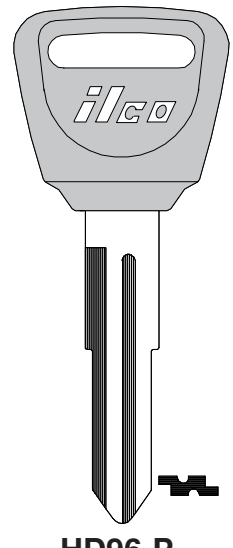

HD96-P
—

ILCO
EZ

ACURA

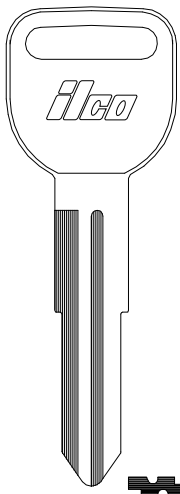

X194
HD97

VALET FOR X193 & HD96-P

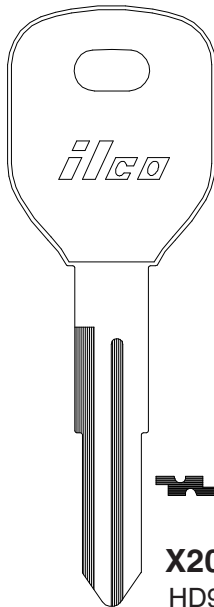

X204
HD99

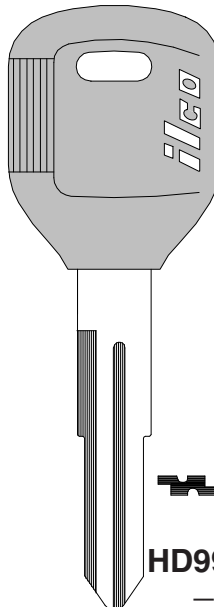

HD99-P
—

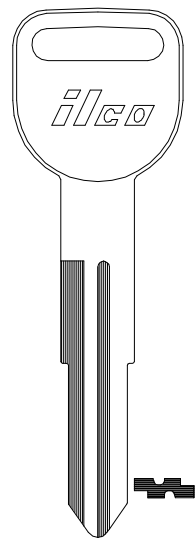

X205
HD100

VALET FOR X204 & HD99-P

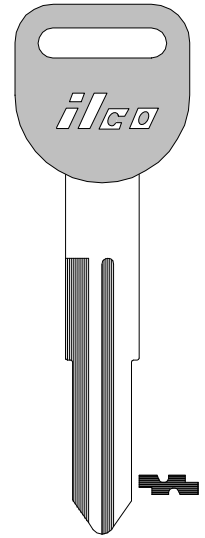

HD100-P
—

ILCO
EZ

ACURA

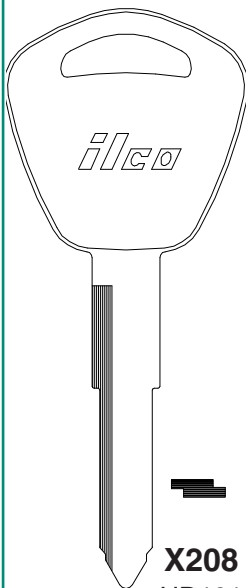

X208
HD101

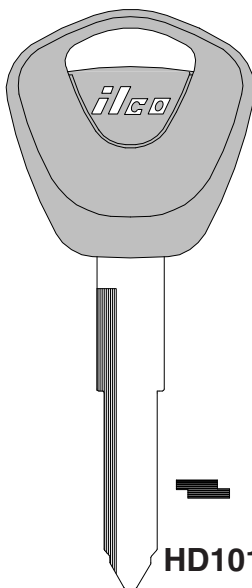

HD101-P
—

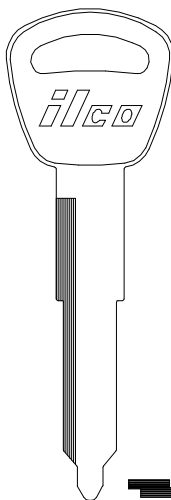

X209
HD102

VALET FOR X208 & HD101-P

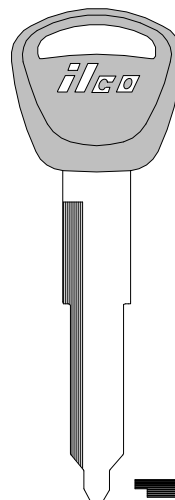

HD102-P
—

VALET FOR X208 & HD101-P

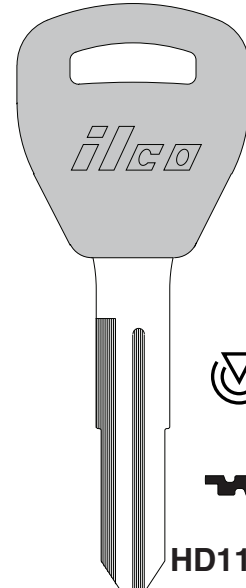

HD111-PT

ILCO
EZ

ACURA

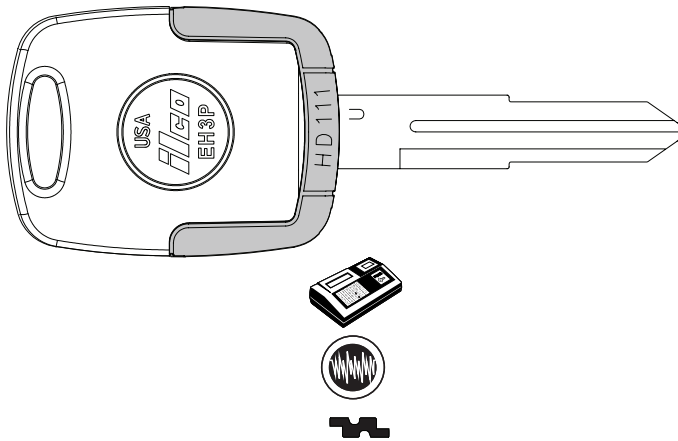

EH3P
(Head Only)

EB3-U-HD111
(Blade Only)

EK3P-HD111
(Complete Key)

ILCO
EZ

ACURA

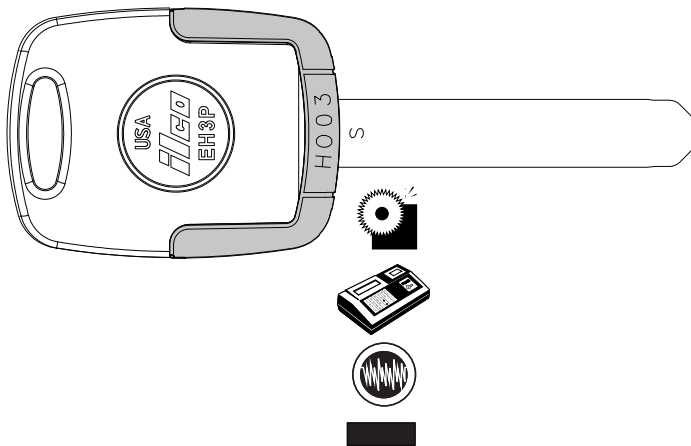

EH3P
(Head Only)

EB3-S-HO03
(Blade Only)

EK3P-HO03
(Complete Key)

ALFA ROMEO

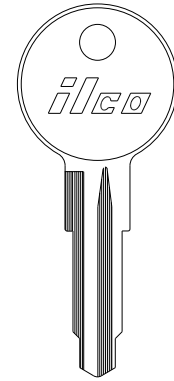

FS1
—

ILCO
EZ

ALFA ROMEO

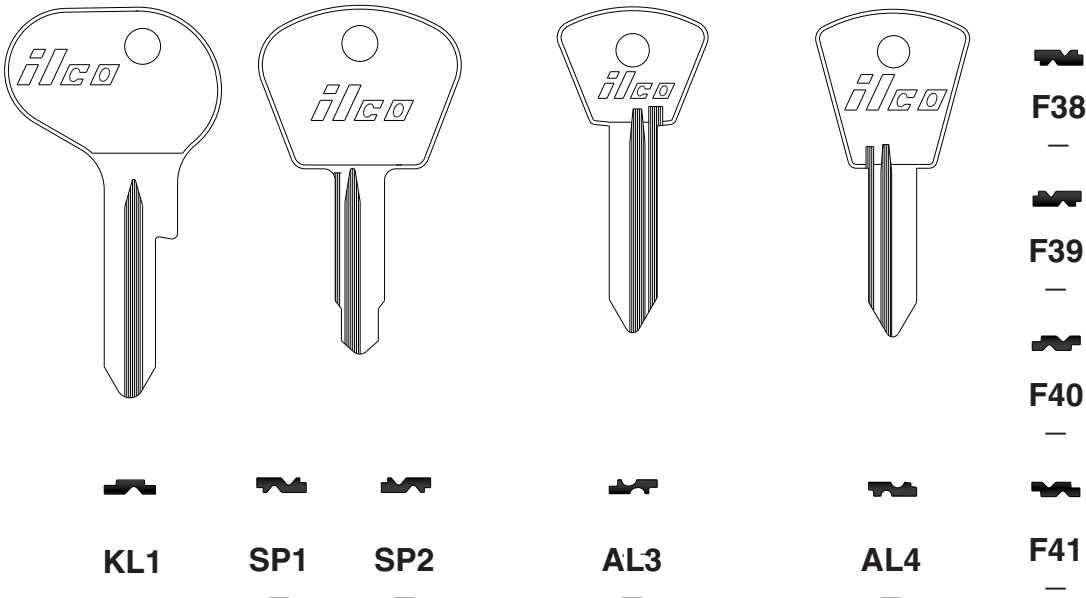

ILCO
EZ

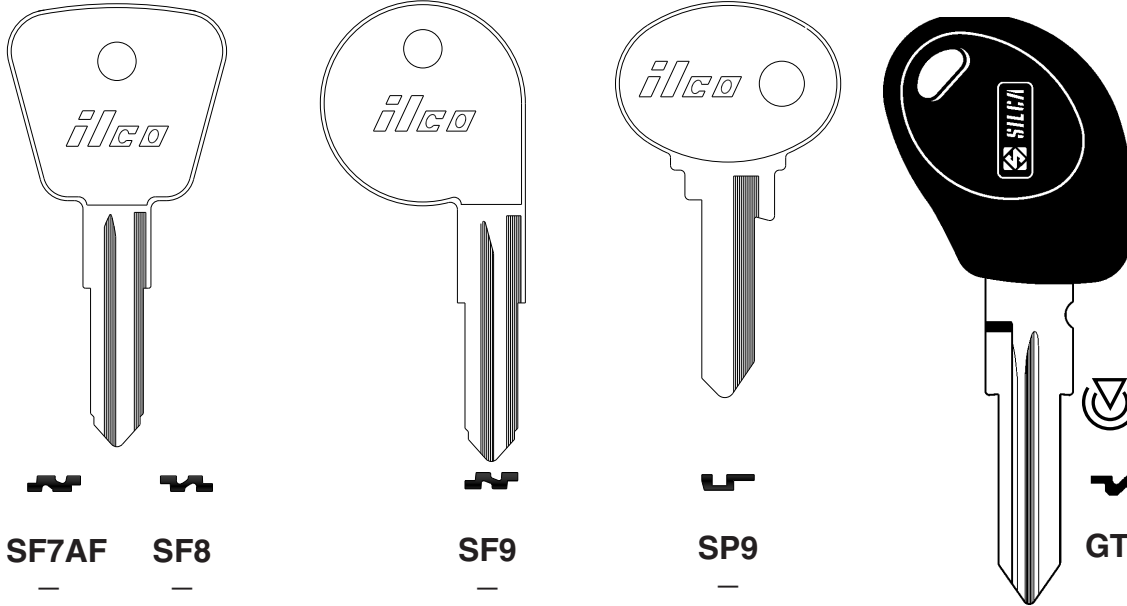
ALFA ROMEO

ILCO
EZ

SF7AF
—

SF8
—

SF9
—

SP9
—

GT15RT2
—

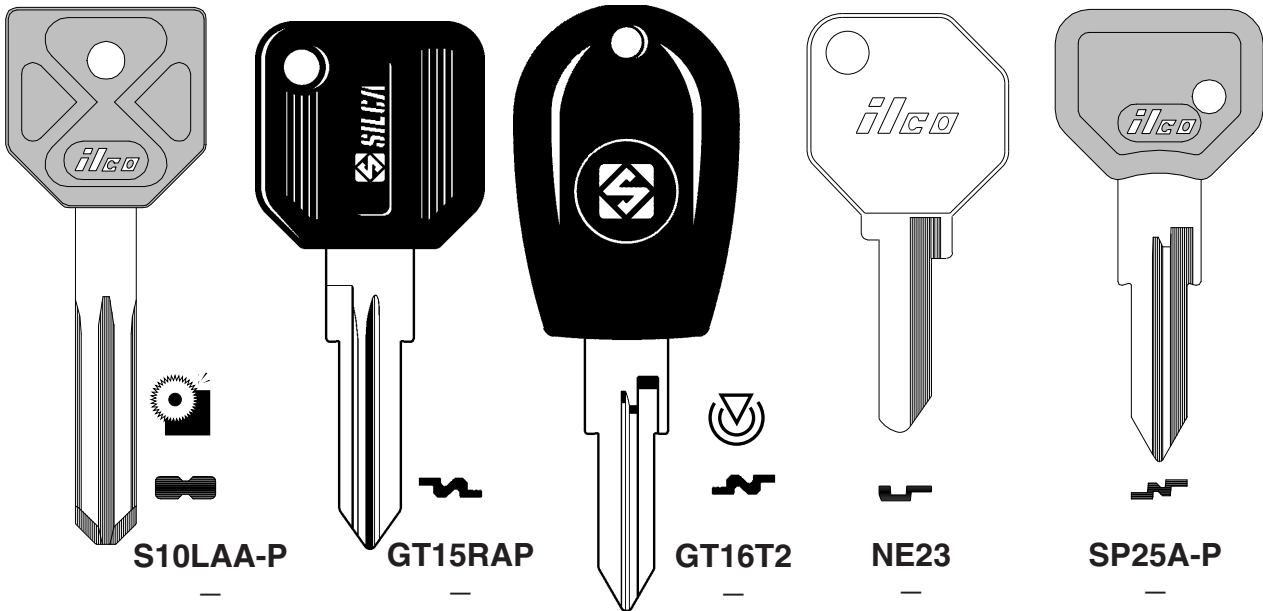
ALFA ROMEO

ILCO
EZ

S10LAA-P
—

GT15RAP
—

GT16T2
—

NE23
—

SP25A-P
—

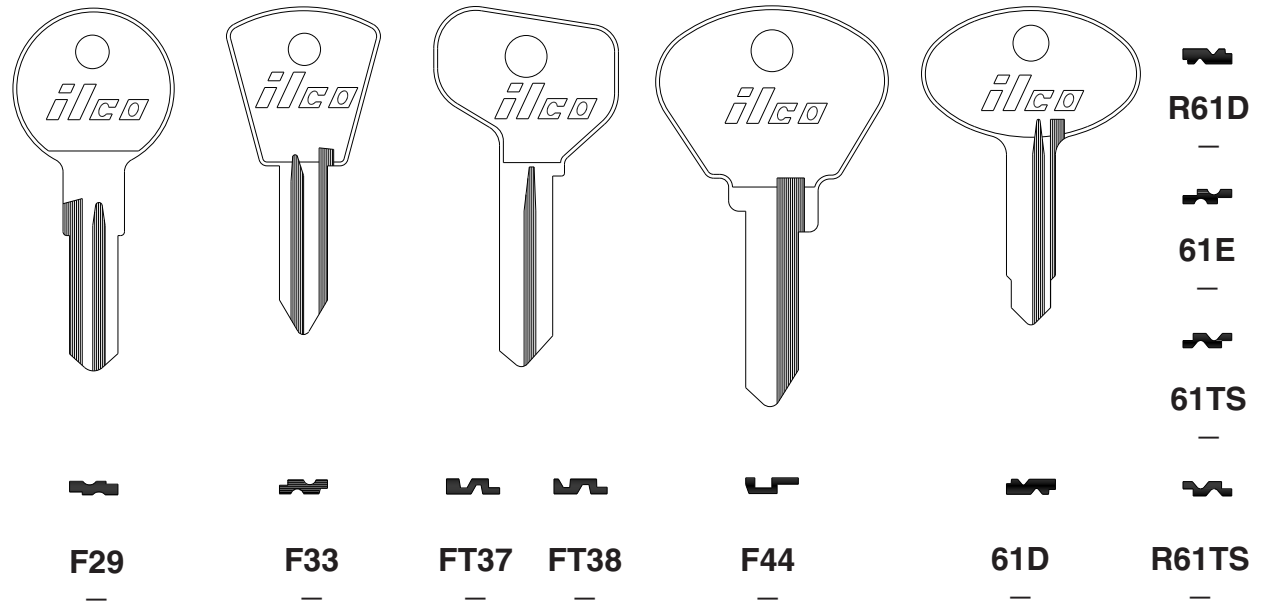
ALFA ROMEO

ILCO
EZ

F29
—

F33
—

FT37
—

FT38
—

F44
—

61D
—

R61TS
—

R61D
—

61E
—

61TS
—

ALFA ROMEO

VEHICLE

sec 1 page 4

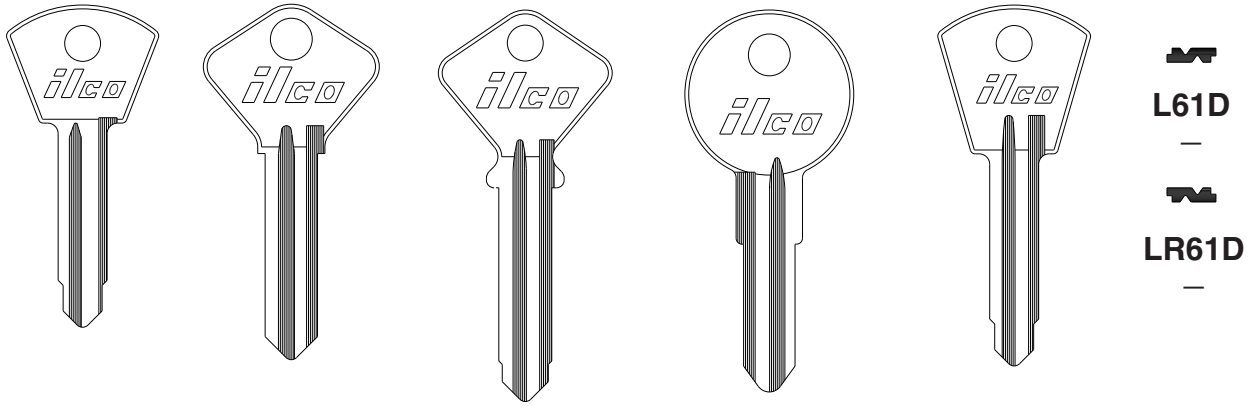

L61D
—
 LR61D
—

61F — 61G — R61G — 61GA — R61GA — 61H — R61H — H61G —

ILCO
EZ

ALFA ROMEO

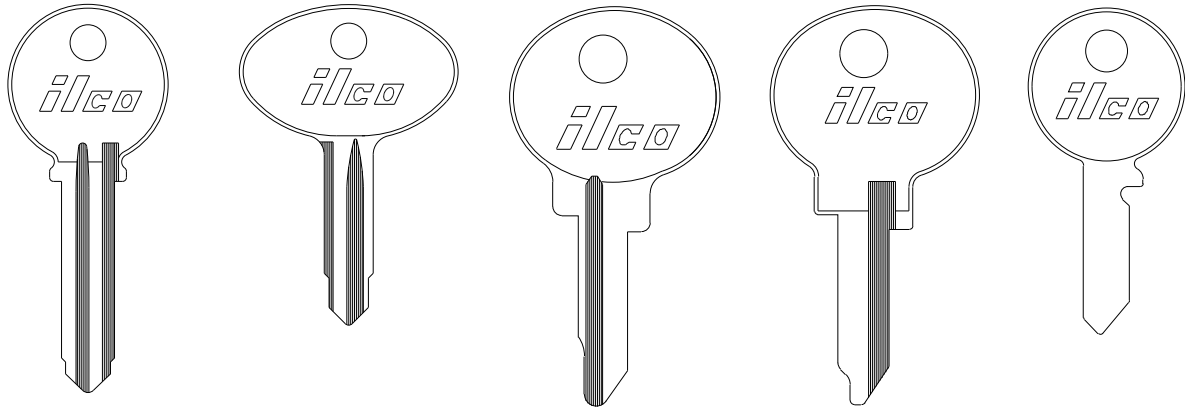

L61G — LR61G — R61ST — R62TS — RE61N — RE61XR — 62DG — R62DG —

ILCO
EZ



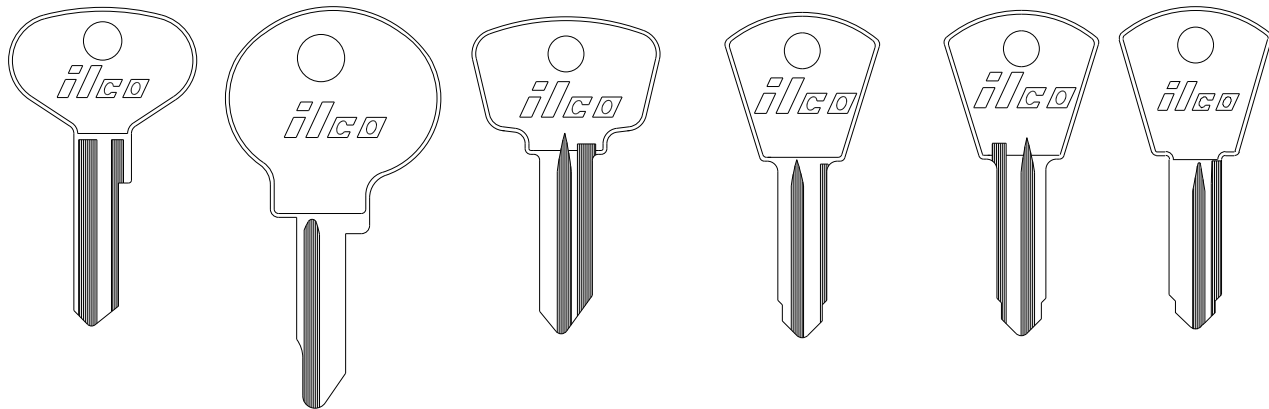







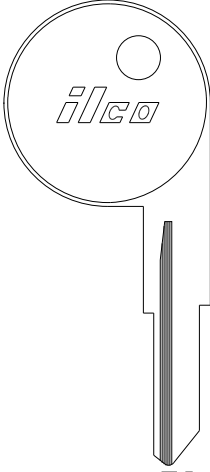

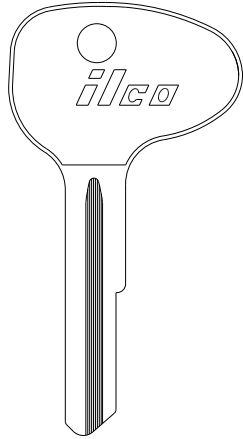
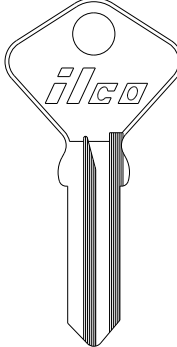
ALFA ROMEO

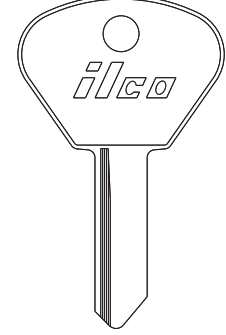









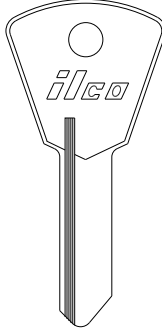

HR62DG — 63M — 63SP — R63SP — 63ST — R63ST — 63TS — R63TS —

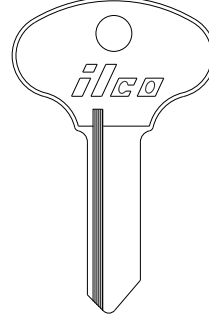
ILCO
EZ

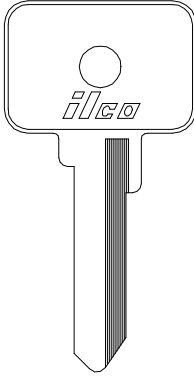
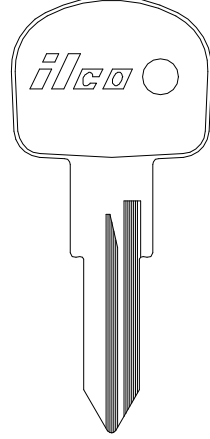
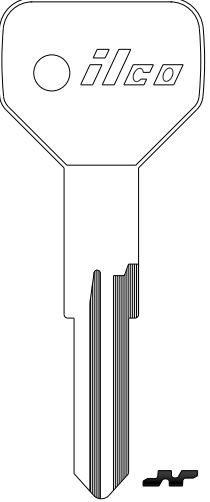

ALFA ROMEO

ILCO EZ		 X78 SP8			 F91CR —		 F91F —
		 X79 SP7			 F91C2 —		 F91G —
					 F91C8 —		 F91H —
		 X64 SP6	A81N —	F91C —		F91E —	

ALFA ROMEO

ILCO EZ		 F91FH —		 F91FS —			
		 F91GH —		 F91GS —			
		 F91HH —		 F91HS —			
		 F91EH —	F91ES —		X109 FT43	X152 FT46	X166 FT48

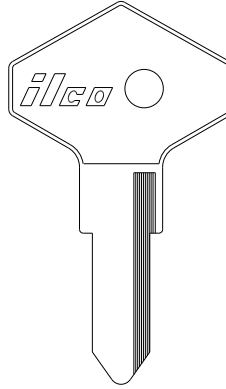
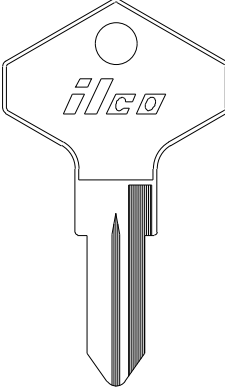
AMERICAN MOTORS / JEEP / RENAULT

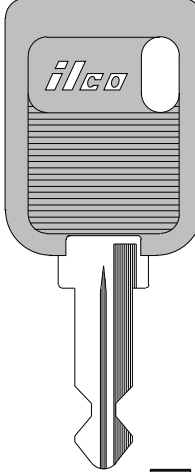
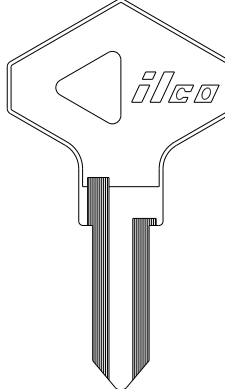
ILCO EZ					
	X85 NE36	X92 RN25	X116 RN24	RN24-P —	X122 RN29

AMERICAN MOTORS / JEEP / RENAULT

VEHICLE

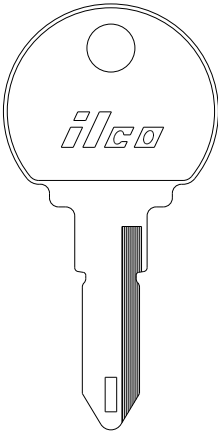

X147
RN30

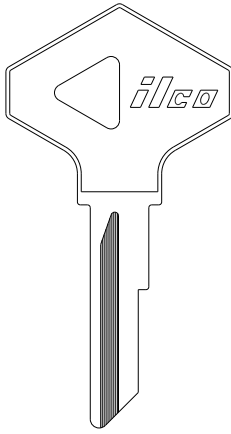

X150
RN27

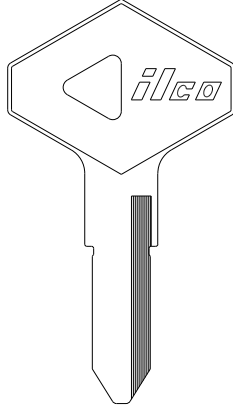

X171
RN31

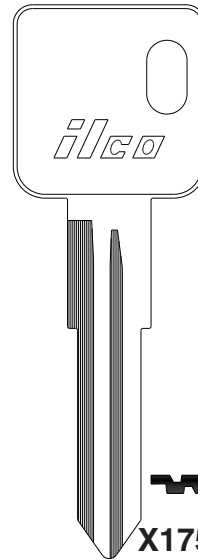

X175
RN32

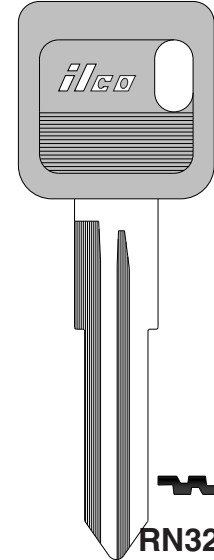

RN32-P
—

ILCO
EZ

sec 1 page 6

AMERICAN MOTORS / JEEP / RENAULT

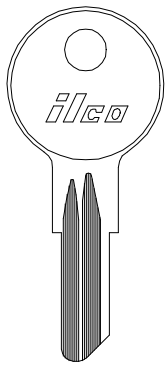

1098DB
B5

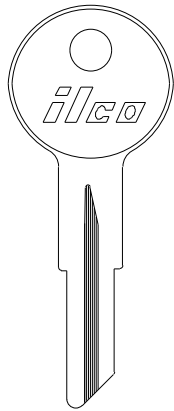

1098NR
RA1

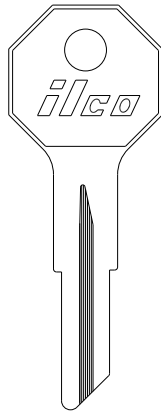

H1098NR
RA2

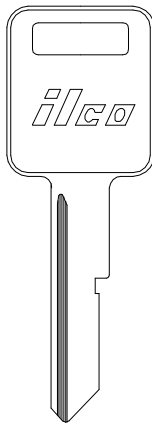

P1098J
B46

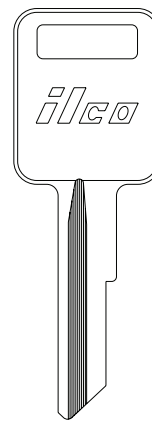

1970AM
RA4

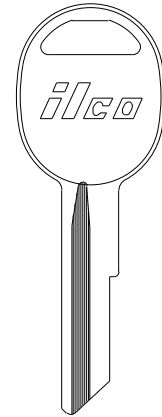

S1970AM
RA3

ILCO
EZ

ARTIC CAT

APRILIA

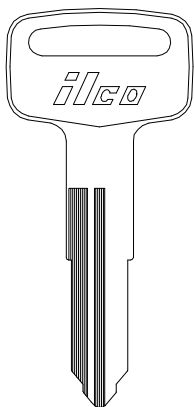

X117
YH48

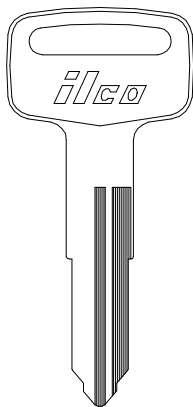

X118
YH49

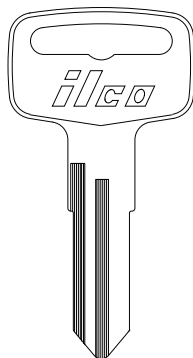

X72
YH36

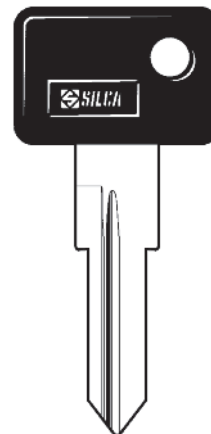

ZD16RP-SI
—

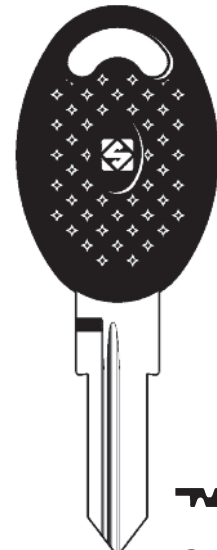

ZD22RBP-SI
—

ILCO
EZ

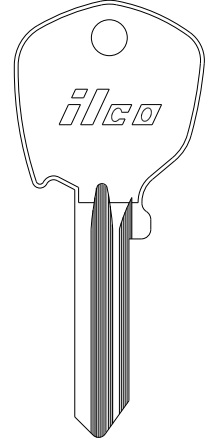
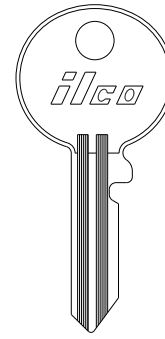
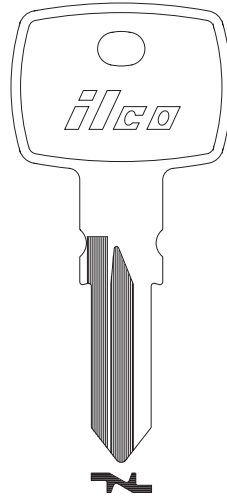
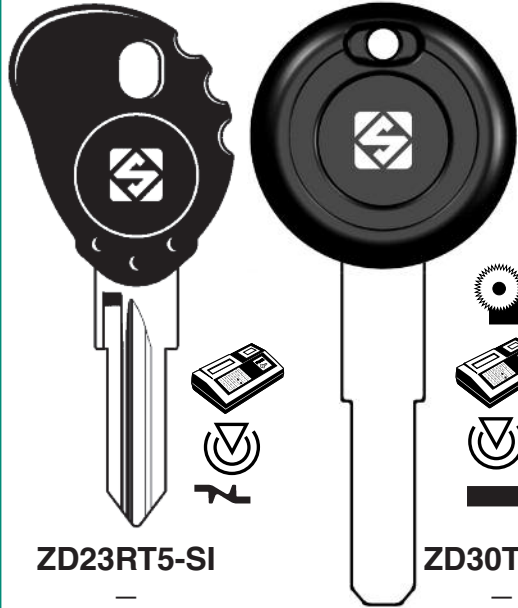
APRILIA
ARIEL
ASTON MARTIN

ILCO
EZ

ZD23RT5-SI
—

ZD30T5-SI
—

X270
TMC1

R62DH
—

FT6R
F81E

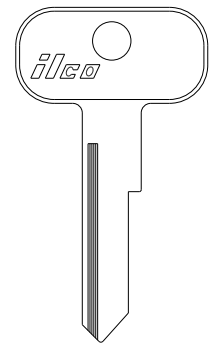
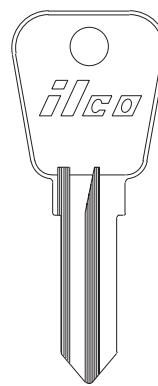
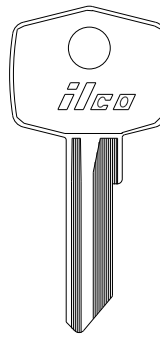
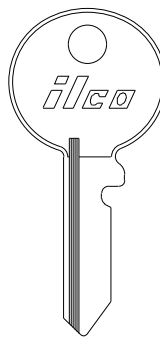
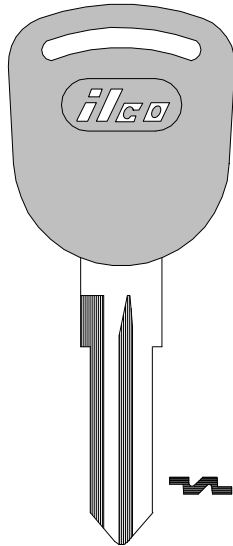
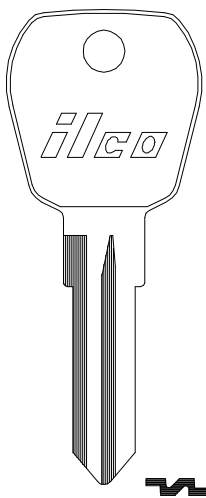
ASTON MARTIN

ILCO
EZ

X86
FC7

FC7-P
—

62DP
—

62FS
—

62FT
F68YT

H62DP
—

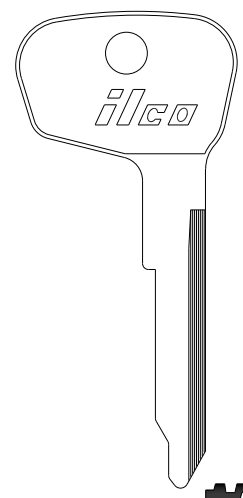
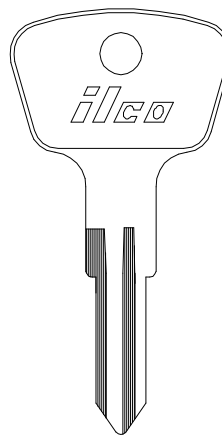
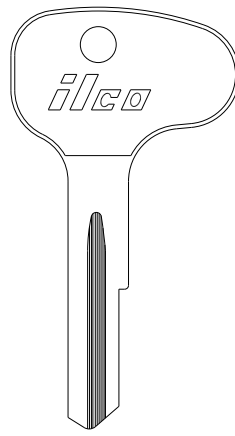
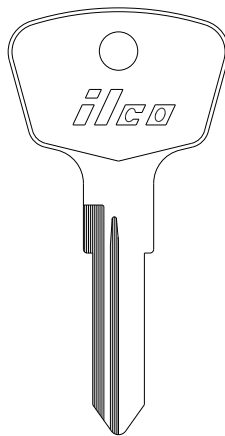
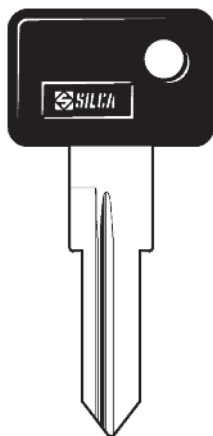
ATALA
AUDI

ILCO
EZ

ZD16RP-SI
—

AD1
—

PR1
—

PA5
—

WT5
—

AUDI

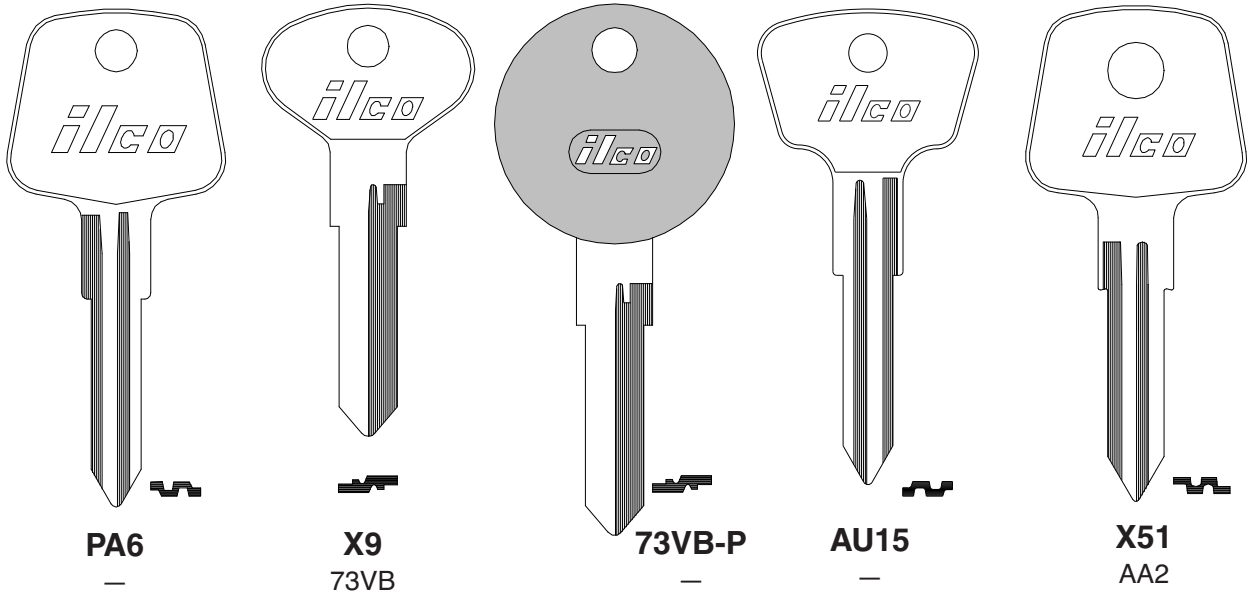

ILCO
EZ

AUDI

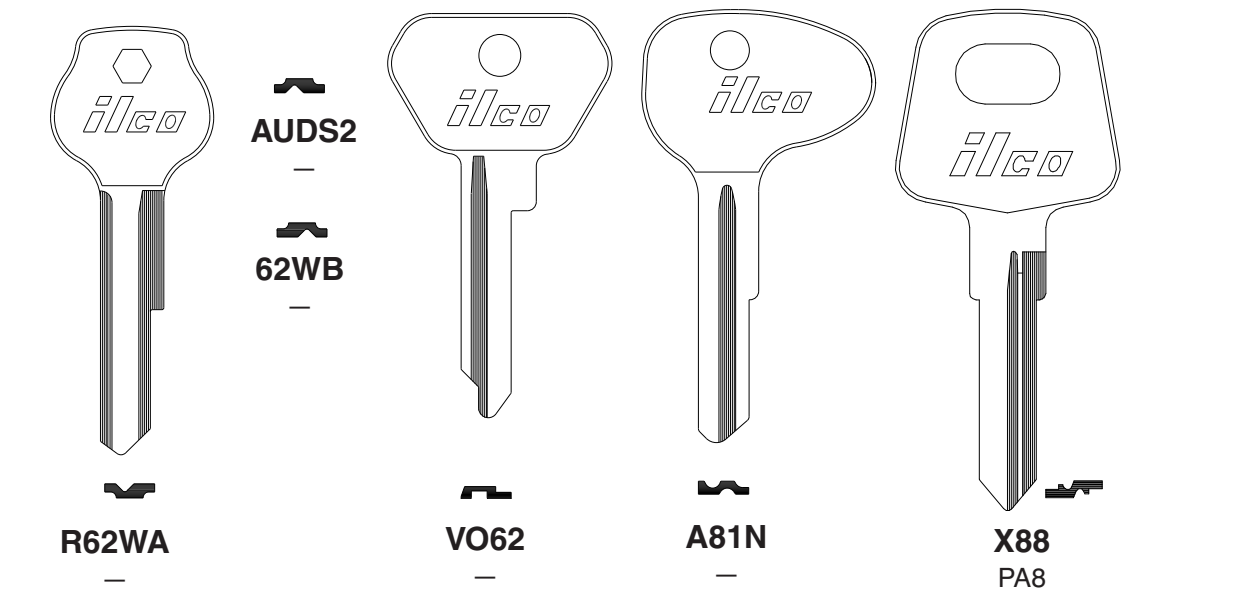

ILCO
EZ

AUDI

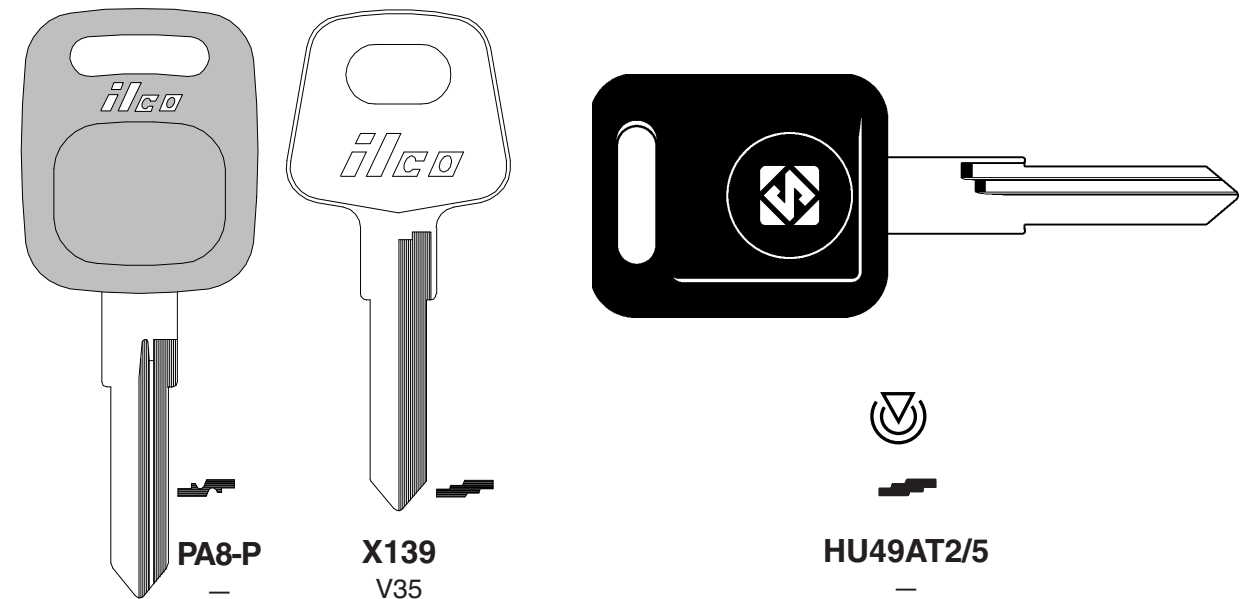

ILCO
EZ

AUDI

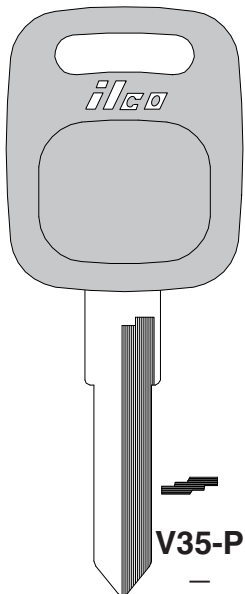
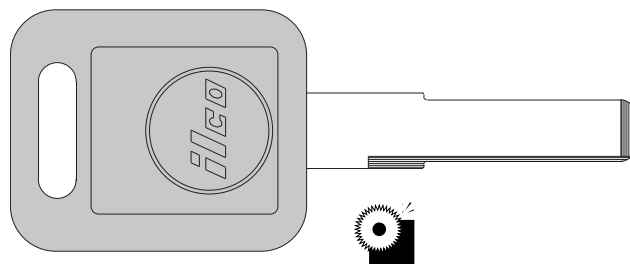

V35-P
—

HU66A-P
—

 ILCO
EZ

VEHICLE

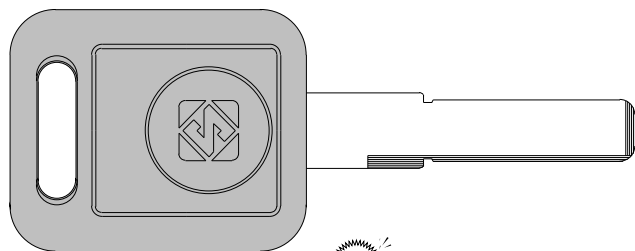
sec 1 page 9

AUDI



HU66AT2
—

AUSTIN

**SEE
BRITISH
LEYLAND**

**HU66AT5
HU66AT6**
—

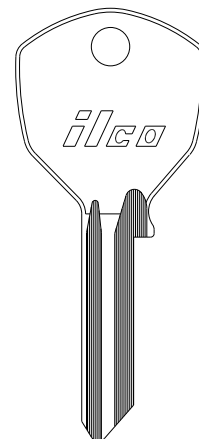
AUTOBIANCHI



DM20
—

 ILCO
EZ

AUTOBIANCHI

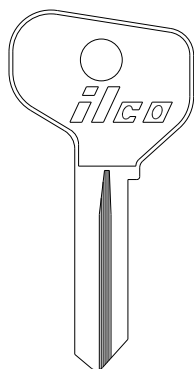

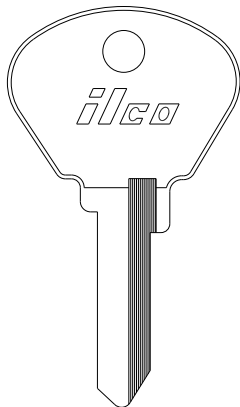
FT37 **FT38**
— —

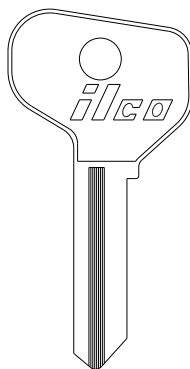
F44
—

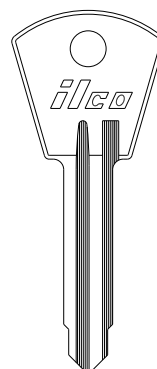
F54
—

H61G
—

L61D
—

LR61D
—

SP5
—

 ILCO
EZ

AUTOBIANCHI

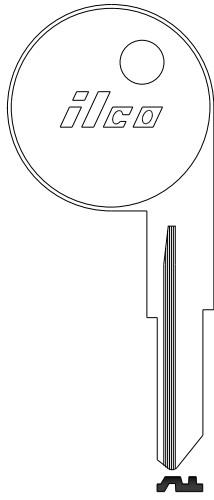

X78
SP8

X79
SP7

X64
SP6

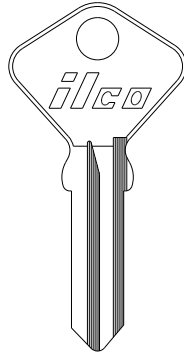

F91C

F91CR

F91C2

F91C8

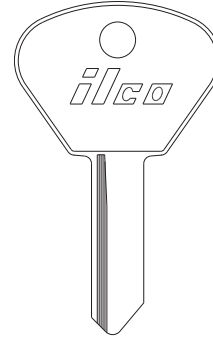

F91E

F91F

F91G

F91H

ILCO
EZ

AUTOBIANCHI

BARRI-LOCK

BASTA LOCK

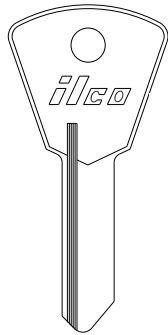

F91FH

F91GH

F91HH

F91EH

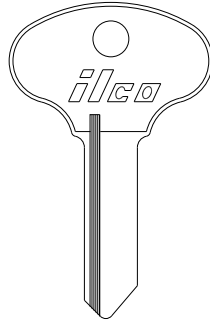

F91FS

F91GS

F91HS

F91ES

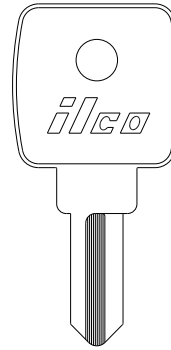

X56

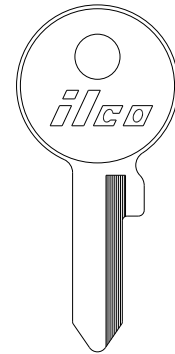

NE30

ILCO
EZ

BEDFORD

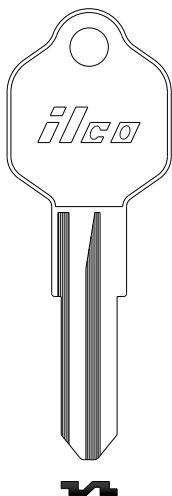

CE3

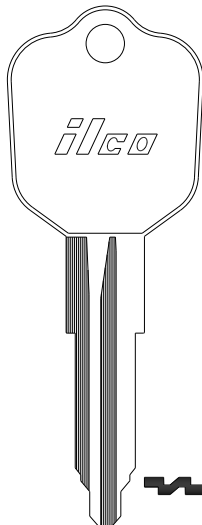

CE5

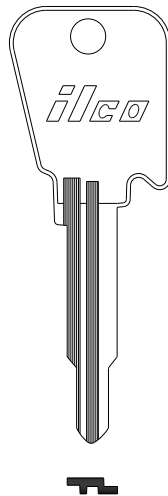

X13
LF4

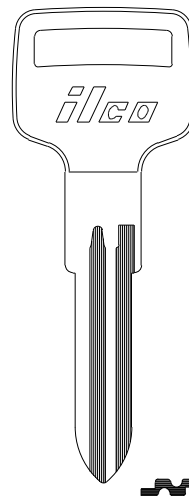

X29
VO73

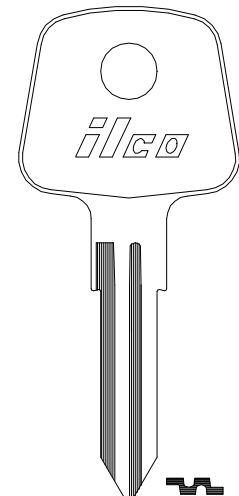

X51
AA2

ILCO
EZ

BEDFORD

BENTLEY

BETA

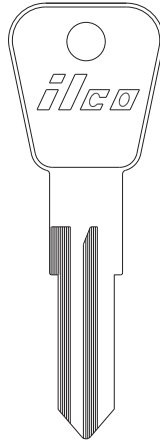
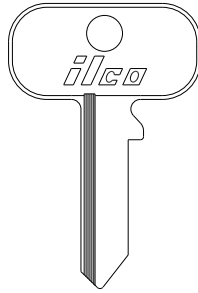
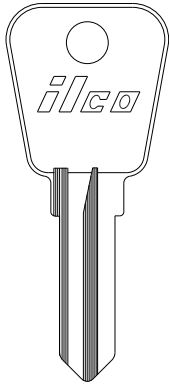

SEE
ROLLS
ROYCE

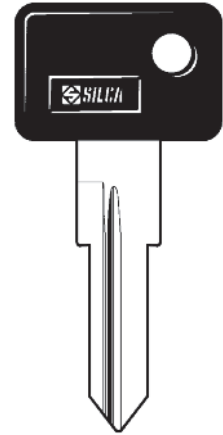

ILCO
EZ

62FT
F68YT

B62DP B62DR
— —

L62FD
—

ZD16RP-SI
—

sec 1 page 11

VEHICLE

BIMOTA

BMW

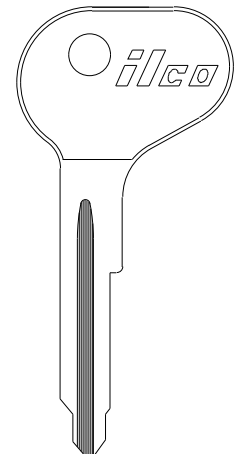
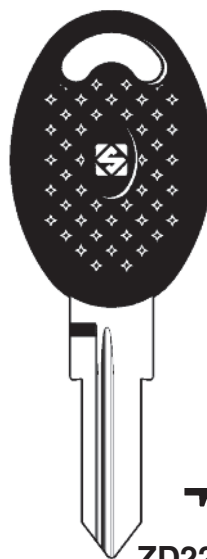

ILCO
EZ

ZD23RCP-SI
—

ZD24RDP-SI
—

ZD22RBP-SI
—

BMW1
—

BMW

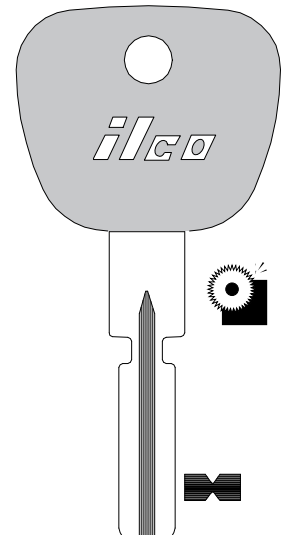
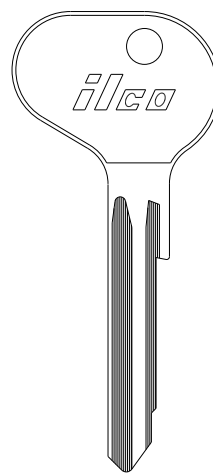
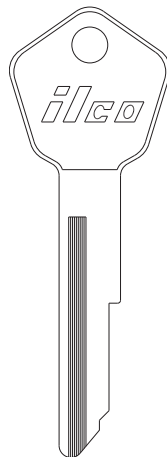
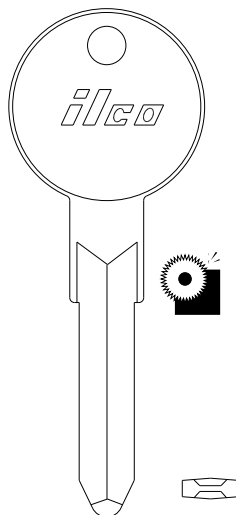
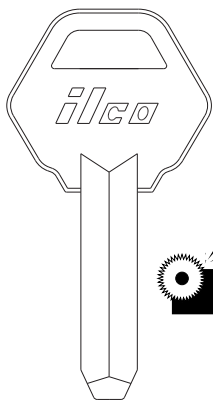

ILCO
EZ

KS1
—

PE1
—

WT3
—

KL4
—

S7BW-P
—

BMW

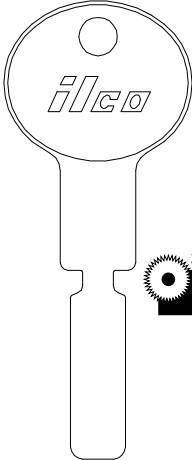

S6BW

—

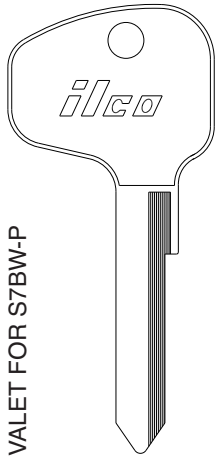

NE8

—

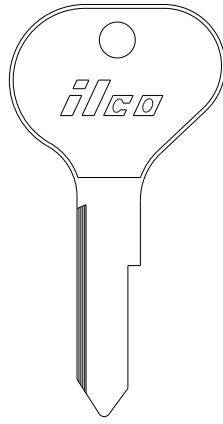

HF20

—

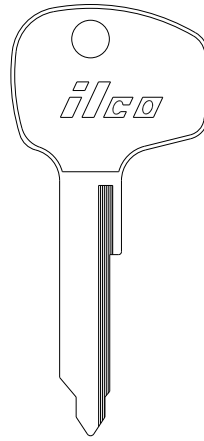

HF26

—

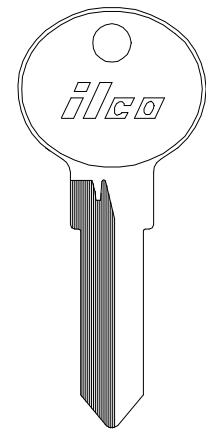

X59

BMW2



VALET FOR S7BW-P

ILCO
EZ

BMW

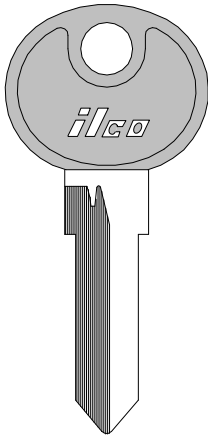

BMW2-P

—

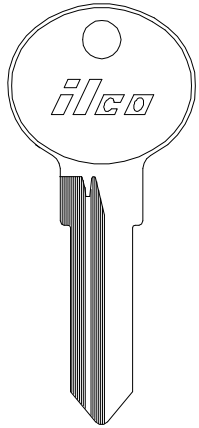

HF40

—

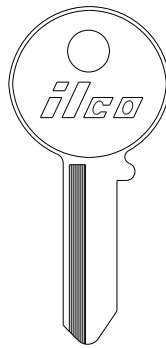

61N

—

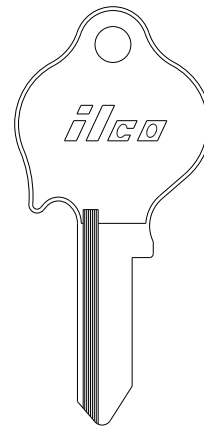

H61VM

—



62VO

—

VALET FOR X59 AND BMW2-P

ILCO
EZ

BMW

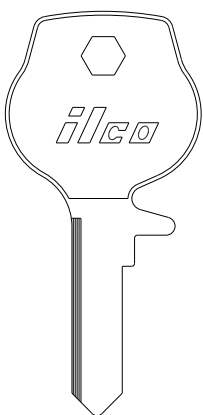

X62VK

—

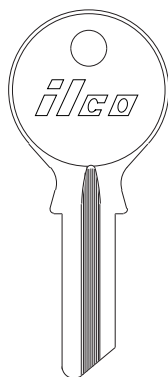

63L

—

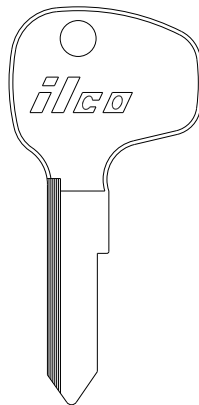

63VP

—

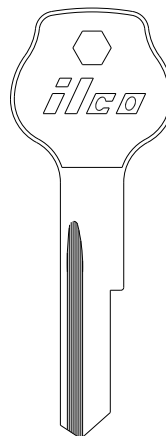

63Y

—



R63Y

—

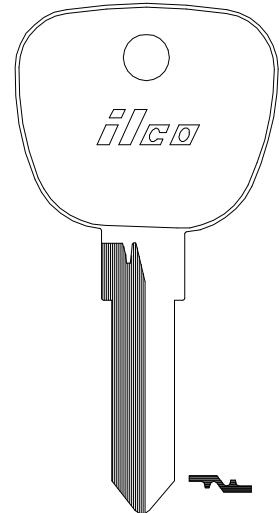

X144

BMW3

ILCO
EZ

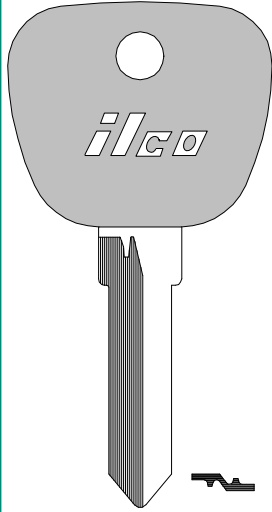
BMW
BMW MOTORCYCLE

BMW3-P

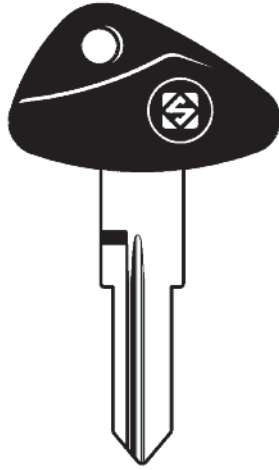
—

ZD28RFP-SI

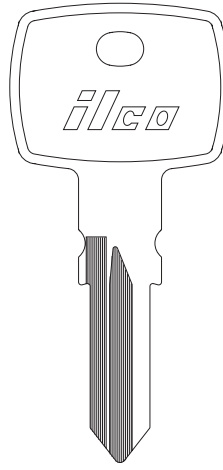
—

X270

TMC1

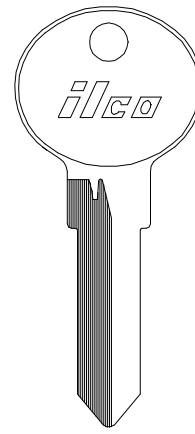
X59

BMW2

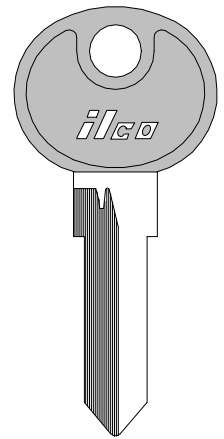

BMW2-P

—

 ILCO
EZ

VEHICLE

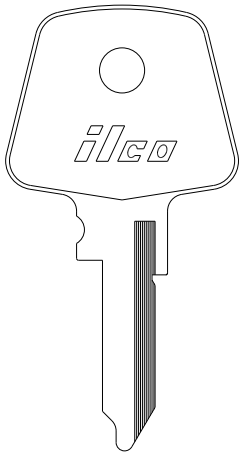
sec 1 page 13

BMW MOTORCYCLE
BOMBARDIER

Y16

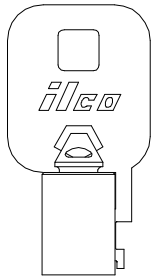
—



 OD .377" - 9.6mm
ID .312" - 7.9mm
(BRASS)

1137B

—

ZD23RCP-SI

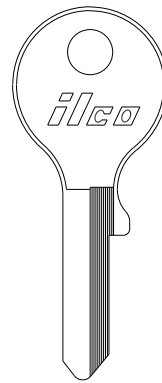
—

N2M

—

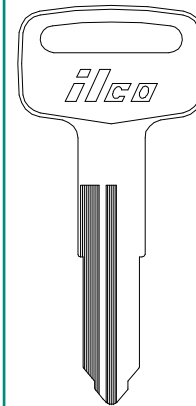

X117

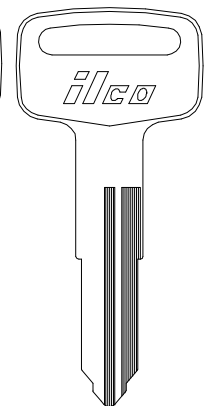
YH48

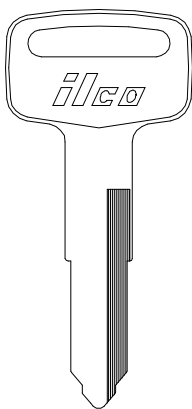

X118

YH49

 ILCO
EZ

BOMBARDIER

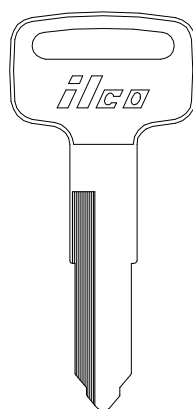
X119

YH47

X120

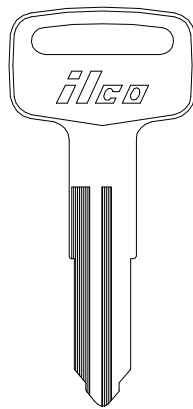
YH46

YH50

—

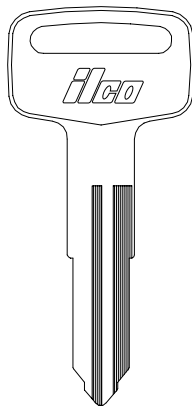
YH51

—

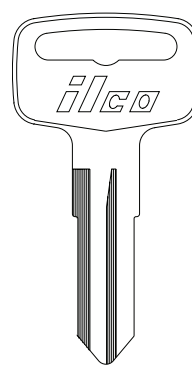
X111

YM55

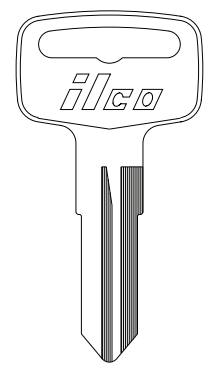
X112

YM56

 ILCO
EZ

BORGWARD

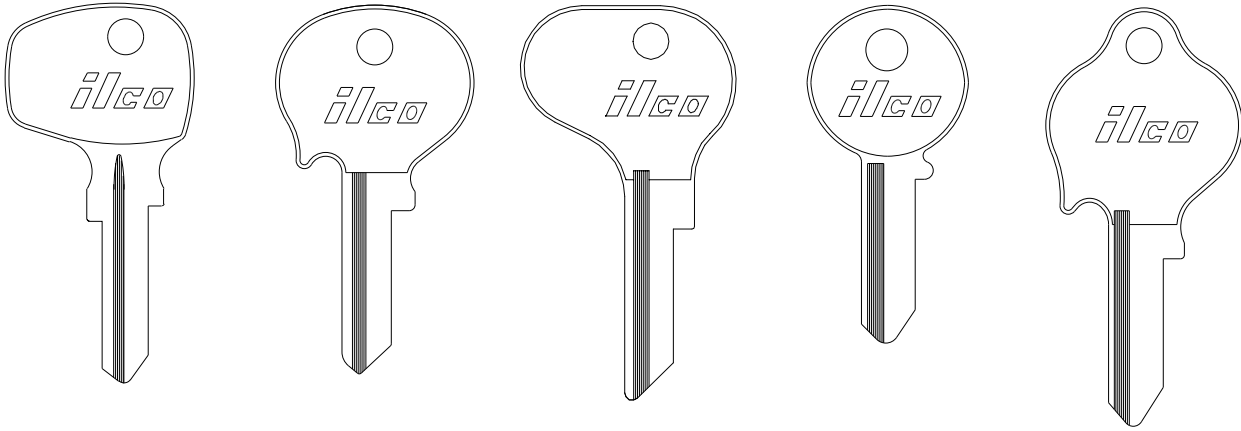

MB5	NE5	NE10	61N	H61VM
—	—	—	—	—

ILCO
EZ

BORGWARD

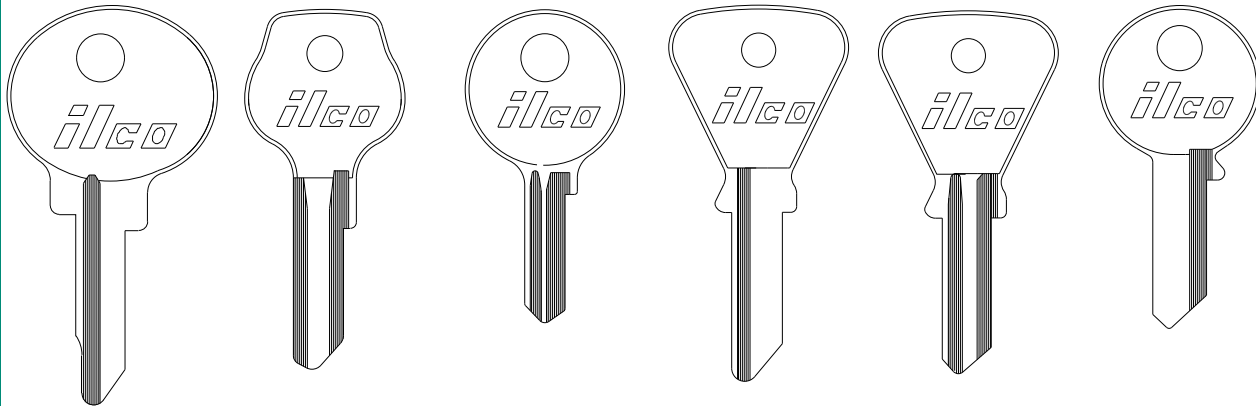

RE61N	62VB	R62VB	62VG	62VH	H62VG	HR62VG	63F
—	—	—	—	—	—	—	—

ILCO
EZ

BORGWARD BOSCH B & S/STRATTEC

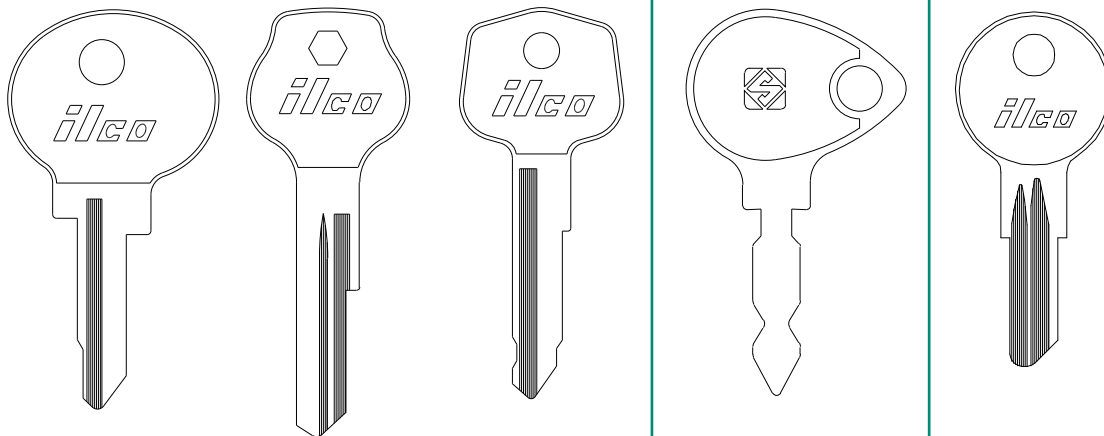

63Q	R63Y	65M	BH12-SI	1098L B3
—	—	—	—	
				1098X
				—
				1098DB
				B5

ILCO
EZ

BRIGGS & STRATTON / STRATTEC

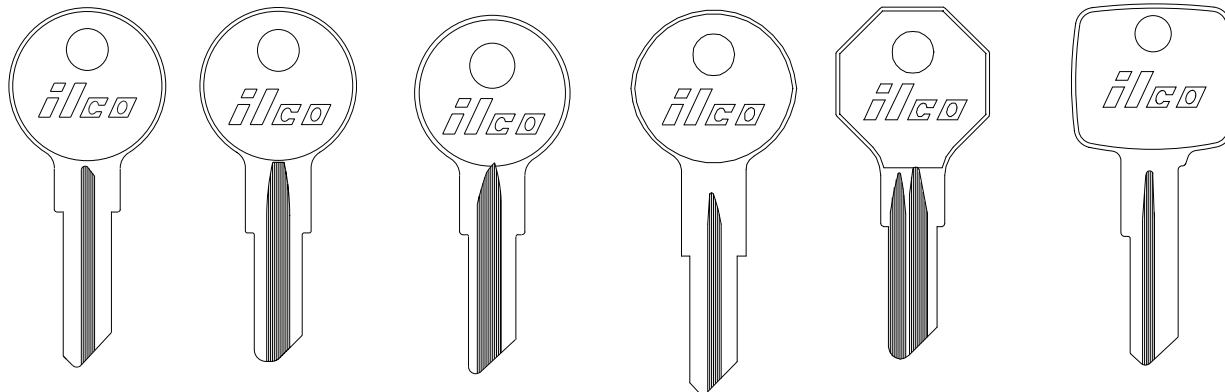

ILCO EZ	1561	1098GM	1098M	1098XL	H1098DB	1595
	—	—	B1	B4	B16	—

BRITISH LEYLAND

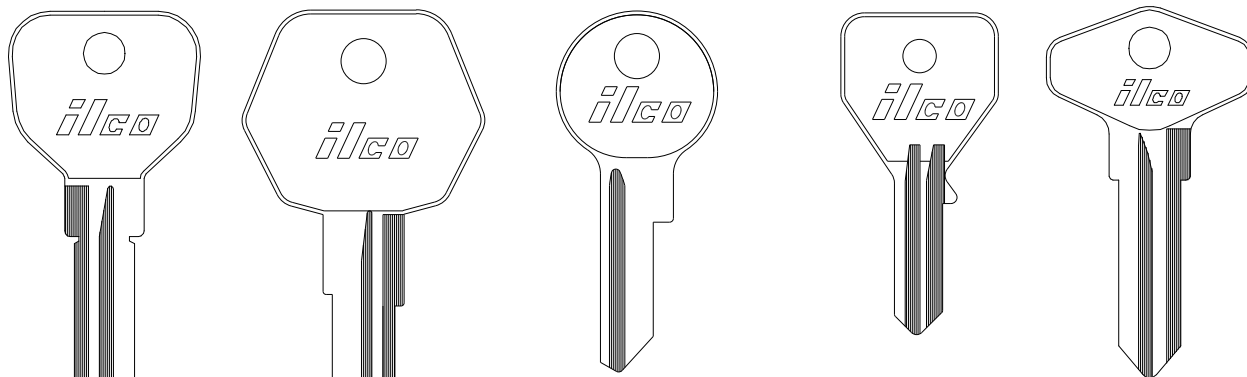

ILCO EZ	MG1	WB2	NE4	BR5	BL6
	—	—	—	—	—

BRITISH LEYLAND

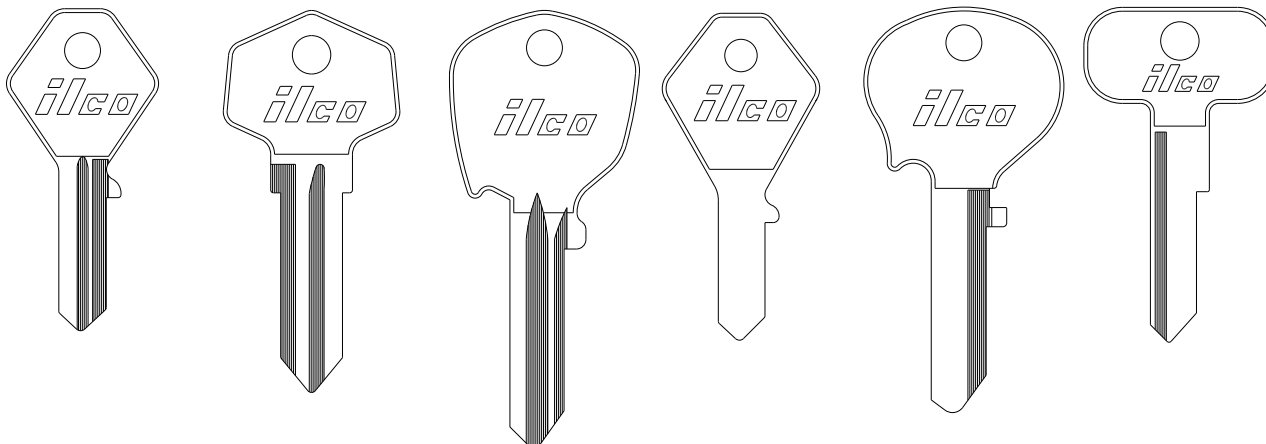

ILCO EZ	BR6	CE6	FT6	FT6R	BR7	NE7	BR9
	—	—	—	F81E	—	—	—

BRITISH LEYLAND

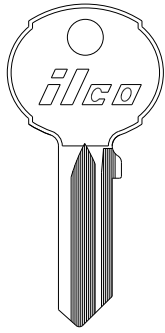

BR13
—

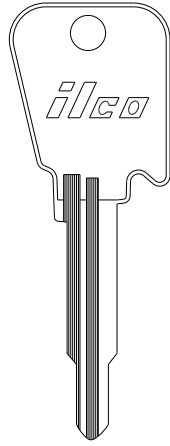

X13
LF4

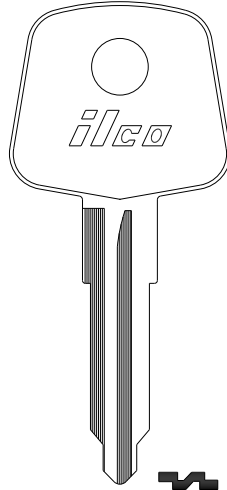

LF15
—



BR16
—

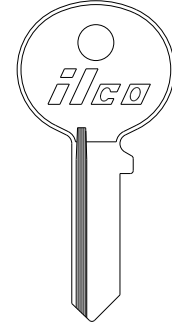

UN16
—

ILCO
EZ

BRITISH LEYLAND

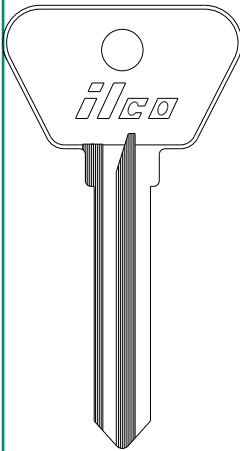

BR20
—

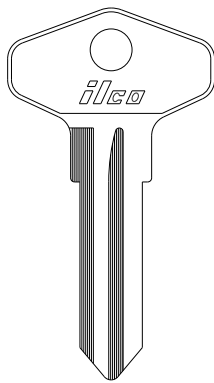

X20
FC2

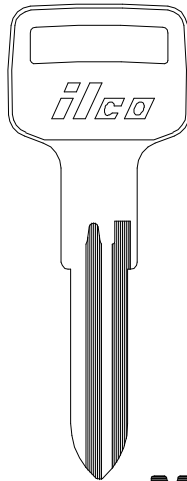

X29
VO73

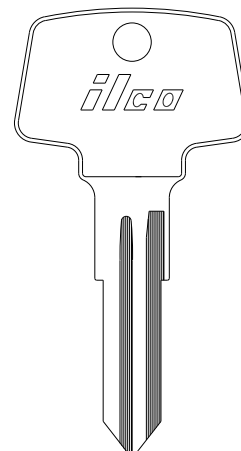

NE49
—

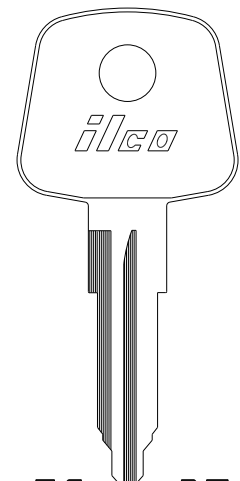

X50
AA3

LF13
—

ILCO
EZ

BRITISH LEYLAND

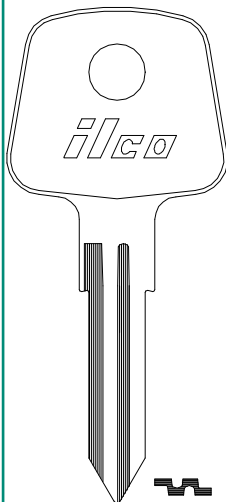

X51
AA2

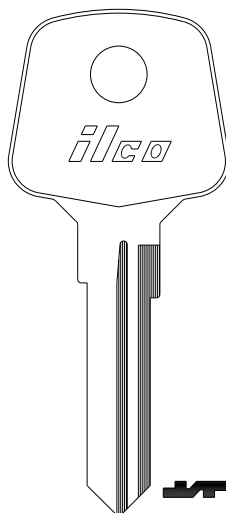

X55
WB1

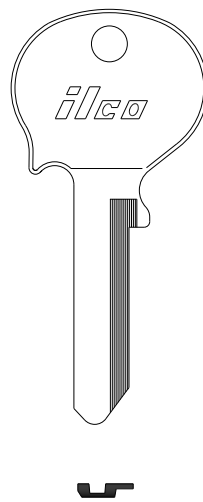

H61VR
—



62DC
—

62DE
—

62DF
—

62DG
—



62DH
—

62DK
—

62DM
—

R62DM
—



62DP
—

F70S
—

M72F
—

ILCO
EZ

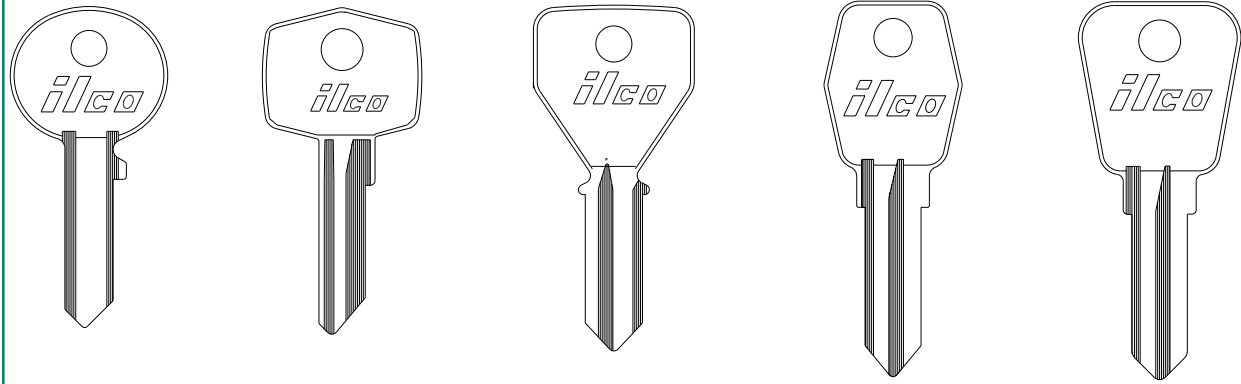
BRITISH LEYLAND

ILCO EZ	62DJ	62DS	62DX	62FS	62FE	62FG	62FT
	—	—	—	—	—	—	F68YT

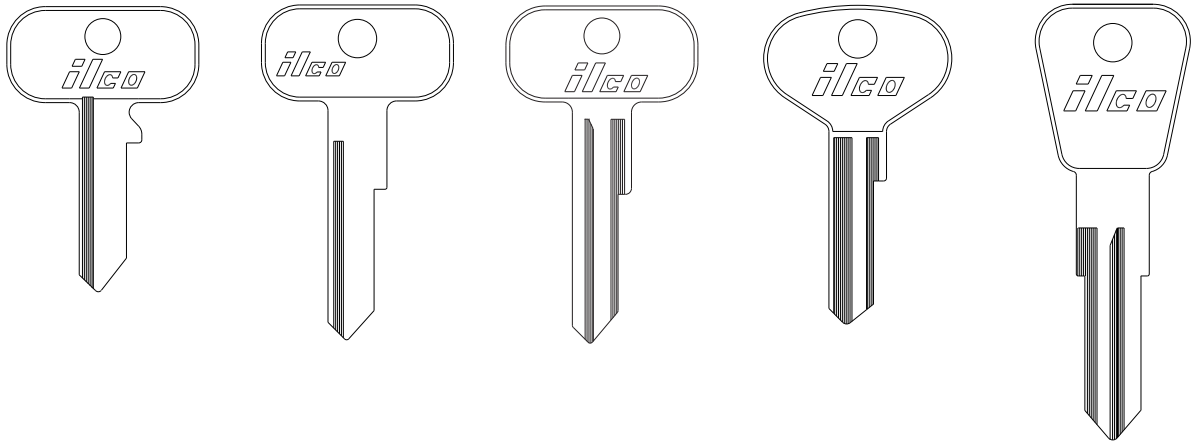
BRITISH LEYLAND



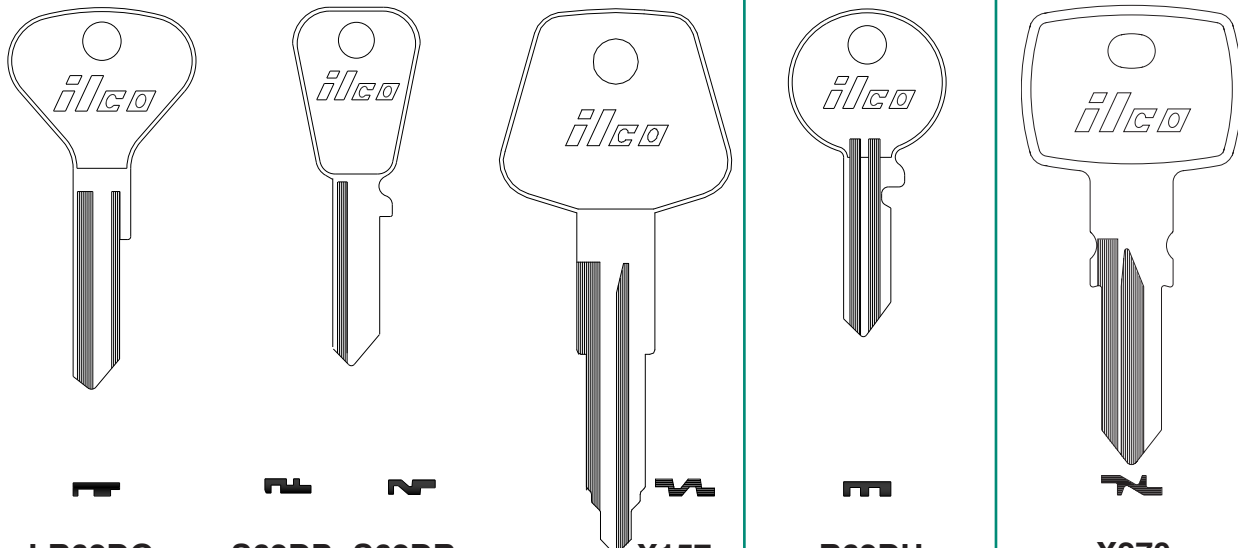



ILCO EZ	B62DP	B62DR	H62DP	H62DR	BR18R	HR62DG	L62FD
	—	—	—	—	—	—	—

BRITISH LEYLAND
B.S.A.
BUELL

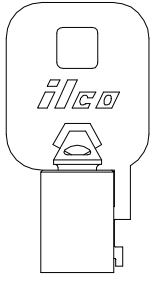

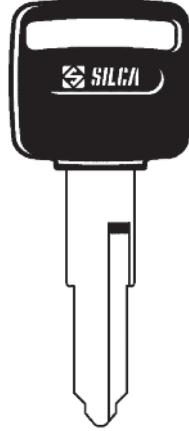

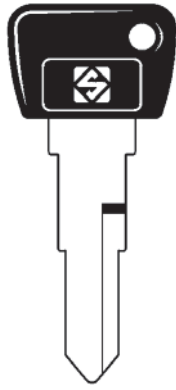

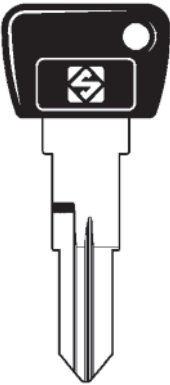

ILCO EZ	LR62DG	S62DP	S62DR	X157	R62DH	X270
	—	—	—	LF17	—	TMC1

VEHICLE

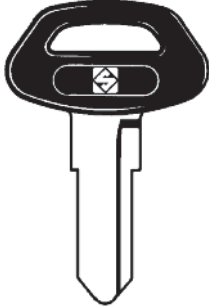

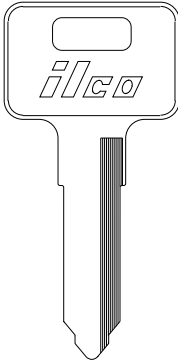

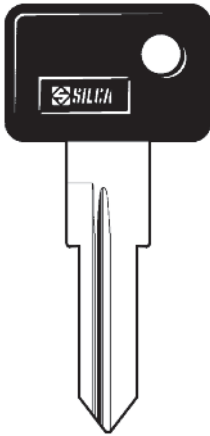

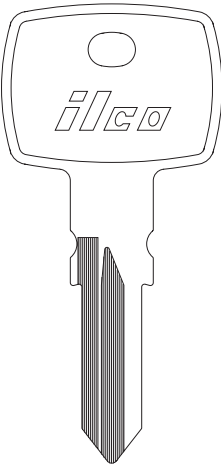

sec 1 page 18

BUELL	BUICK	CADILLAC	CAGIVA	
  OD .377" - 9.6mm ID .312" - 7.9mm (BRASS) 1137B —	<p>SEE GENERAL MOTORS (GM)</p>	<p>SEE GENERAL MOTORS (GM)</p>	  ZD21P-SI —	  CG1P-SI —

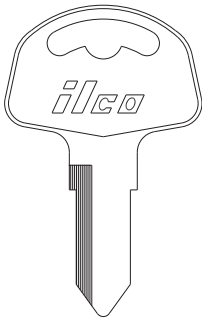
ILCO EZ

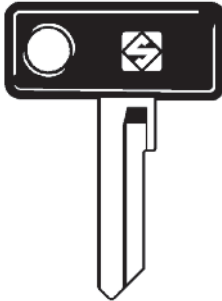
CAGIVA			
  CG2RP-SI —	  SZ4AP-SI —	  X259 —	  ZD16RP-SI —

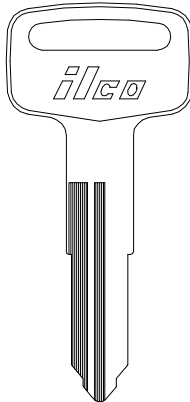
ILCO EZ

CAGIVA		CAN-AM	
  X270 TMC1	  HD57 —	  ZD9P-SI —	  X117 YH48

ILCO EZ

CAN-AM

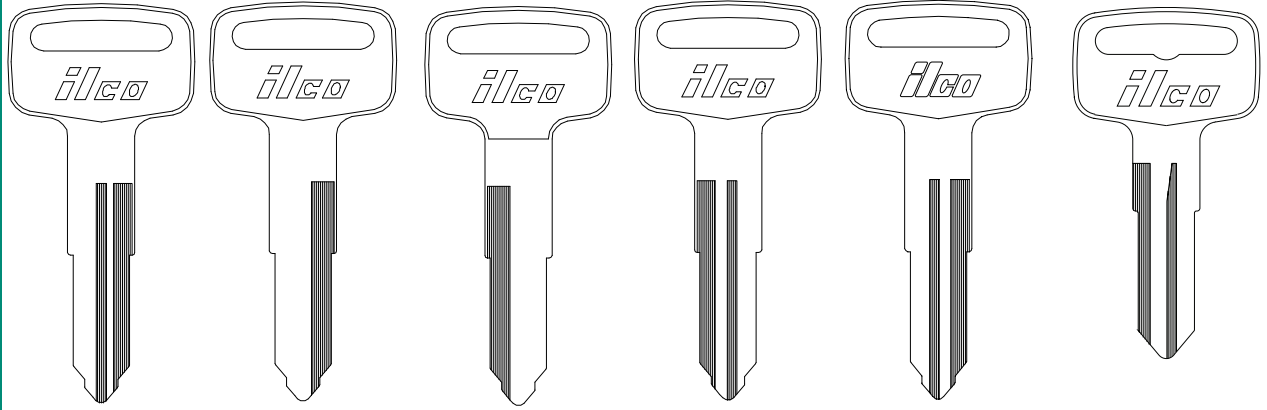

X118
YH49



X119
YH47



X120
YH46



YH50
—



YH51
—



X111
YM55

ILCO
EZ

CAN-AM

CATERPILLAR

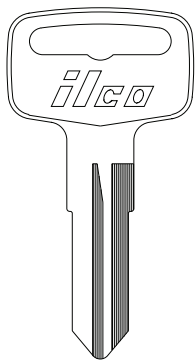

X112
YM56

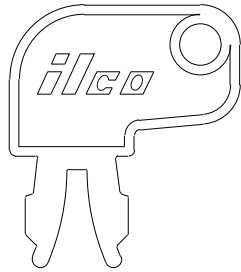

CNA2
—

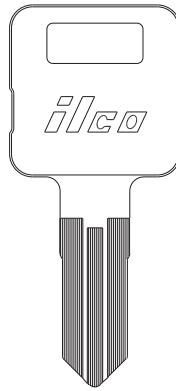

1560
—

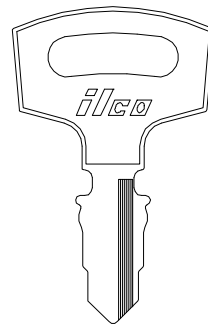

1583
—

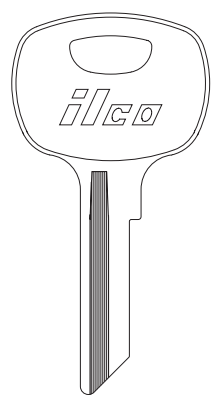

1641
—

ILCO
EZ

CESSNA

CHEVROLET

CHRYSLER

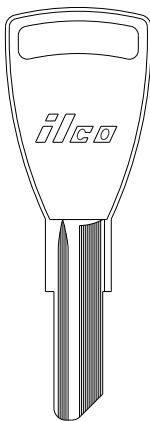

C1054B
—



O1122
Y11



O1122A
Y12

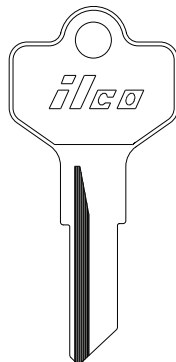

1664
—

**SEE
GENERAL
MOTORS
(GM)**

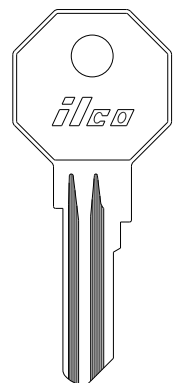

H199A
—

ILCO
EZ

CHRYSLER

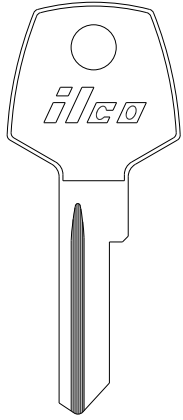

704K

—

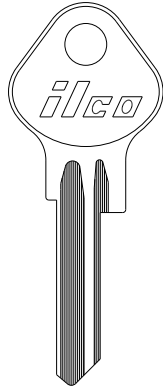

1199C

—

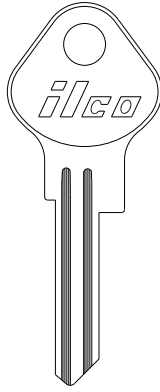

1199D

—

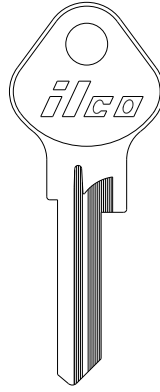

1199DR

—

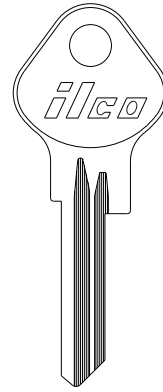

1199E

—

ILCO
EZ

CHRYSLER

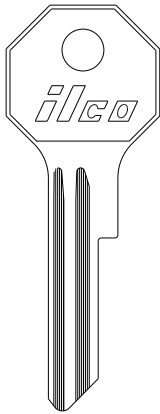

X1199A

—

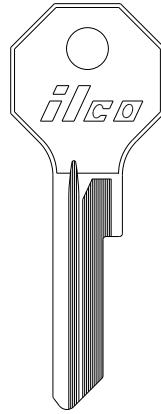

X1199AR

Y133

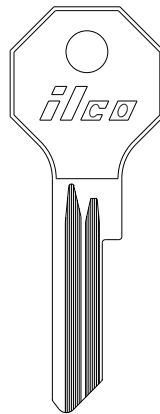

X1199B

—

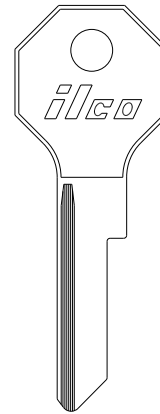

X1199G

—

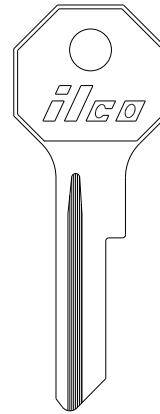

X1199J

—

ILCO
EZ

CHRYSLER

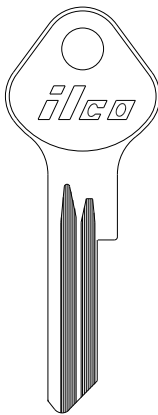

XO1199B

—

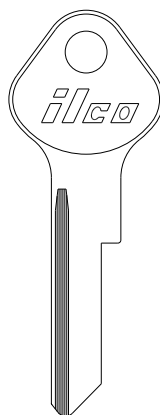

XO1199G

—

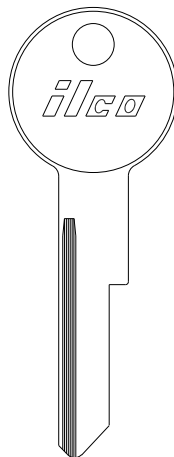

1701G

—

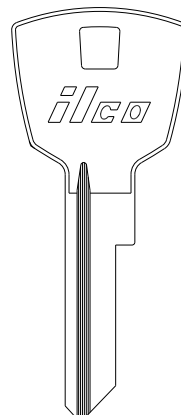

1702K

—

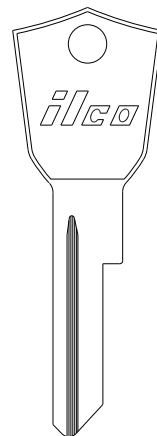

1703K

—

ILCO
EZ

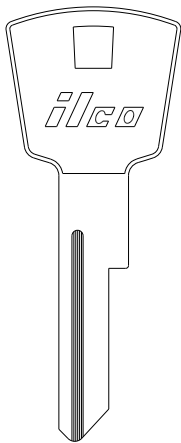
CHRYSLER

1704K

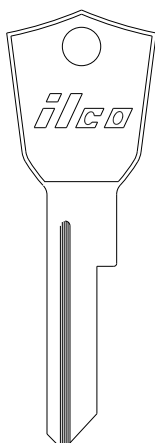
—

1705K

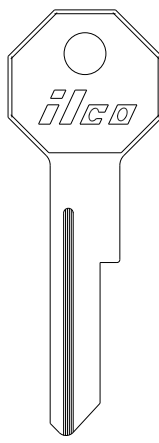
—

1706K

—

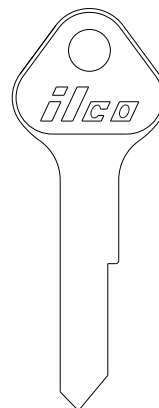
1759P

—

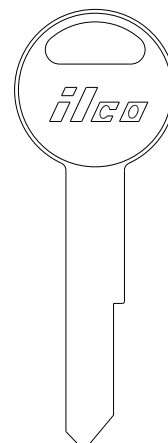
D1759L

—

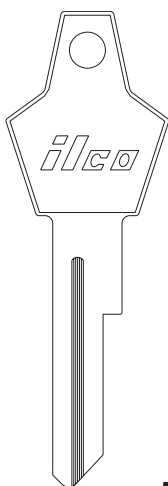
**ILCO
EZ**
CHRYSLER

1764P

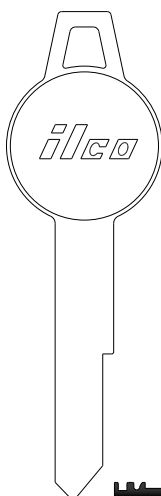
—

1764S

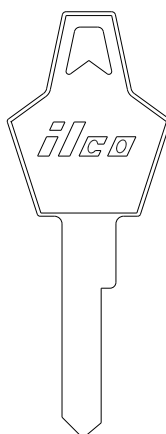
—

1766DT

—

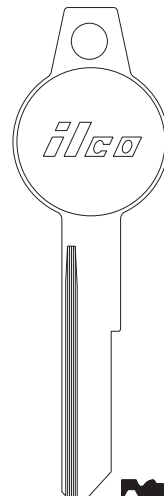
1766S

—

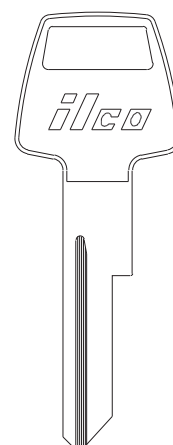
1767CH

Y146

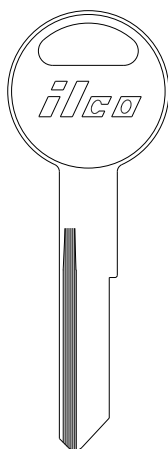
**ILCO
EZ**
CHRYSLER

S1767CH

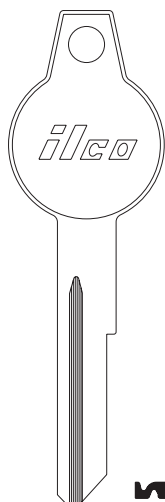
Y138

1767DT

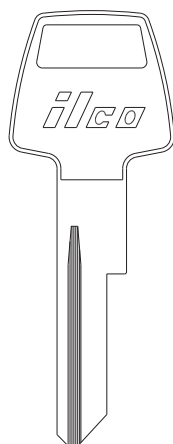
—

1768CH

—

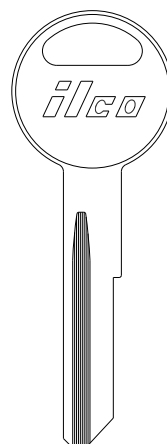
S1768CH

—

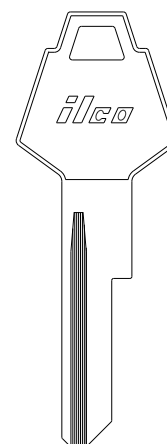
1769CH

—

**ILCO
EZ**

CHRYSLER

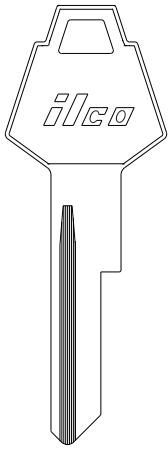

1770CH

—

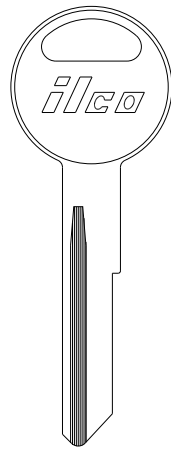

U1770CH

—

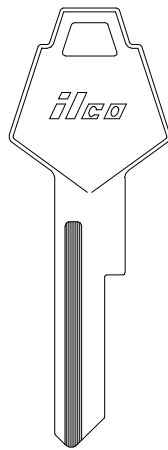

P1770U

Y152

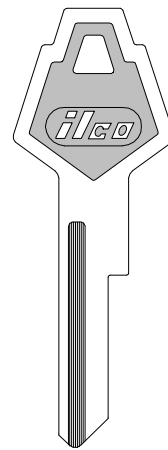

Y152-PC

—

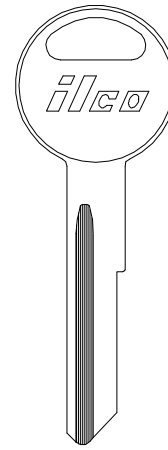

S1770U

Y149

ILCO
EZ

sec 1 page 22

CHRYSLER

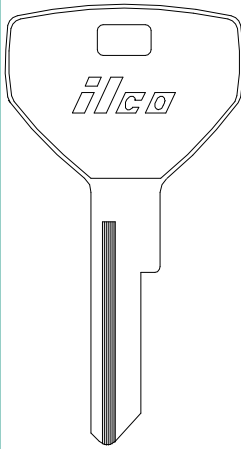

P1786

Y153

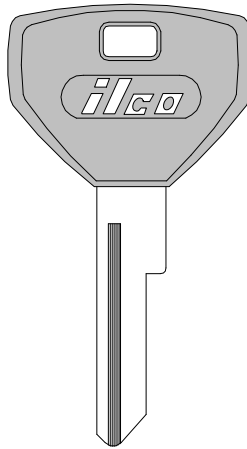

Y153-P

—

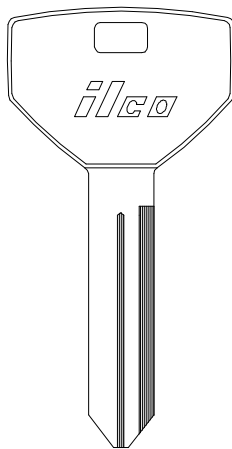

P1789

Y154

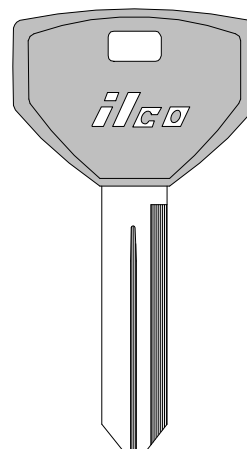

Y154-P (-PC)

—

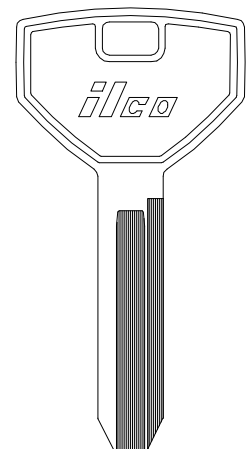

P1793

Y155

ILCO
EZ

CHRYSLER

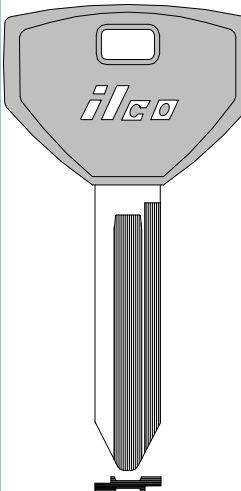

Y155-P (-PC)

—

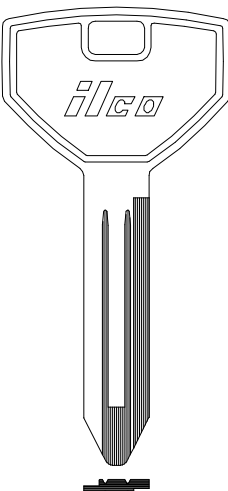

1793V

—

VALET FOR P1793 & Y155-P (-PC)

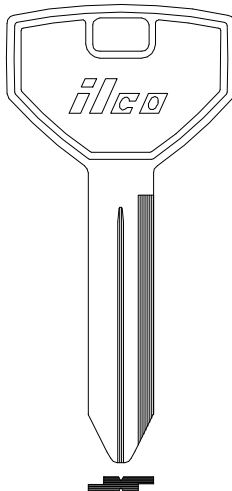

P1794

Y157

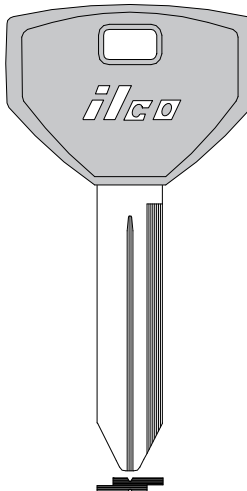

Y157-P (-PC)

—

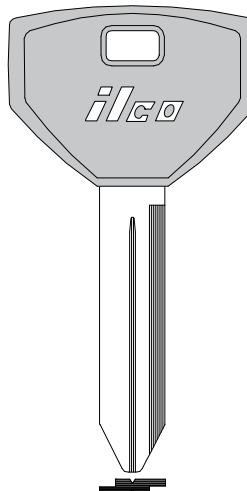

Y157-PC-GRN-N
(GREEN)

ILCO
EZ

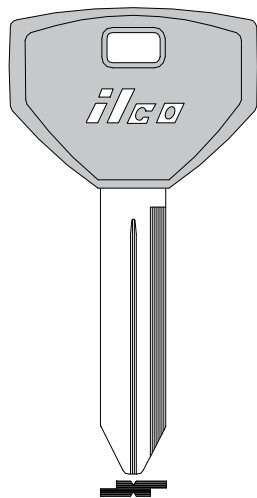
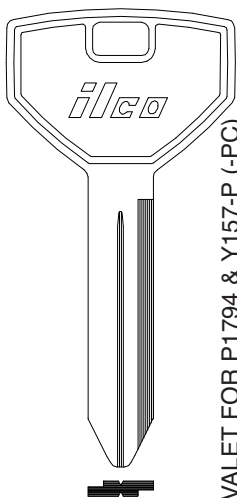
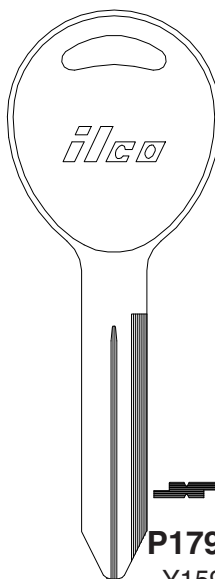
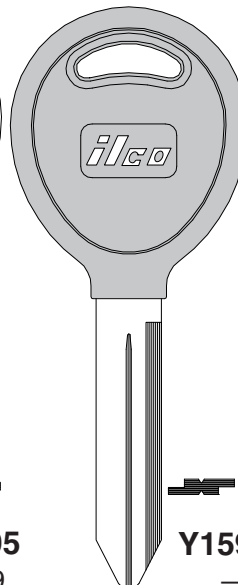
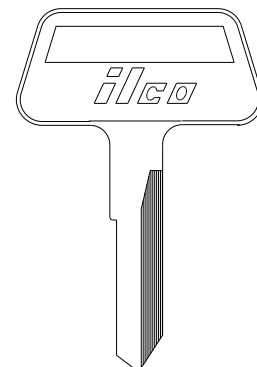
CHRYSLER

Y157-PC-YEL-N
(YELLOW)

1794V
—

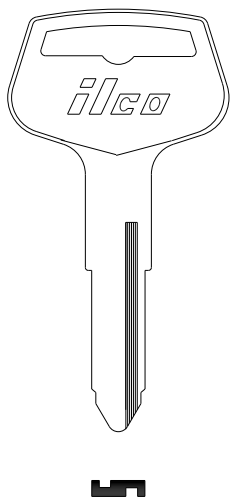
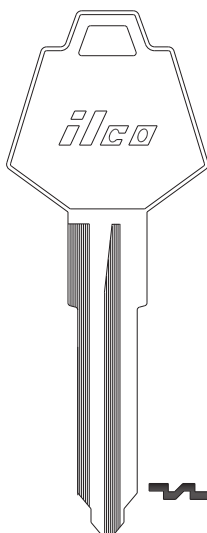
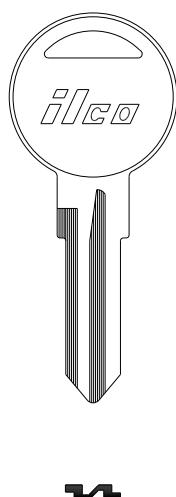
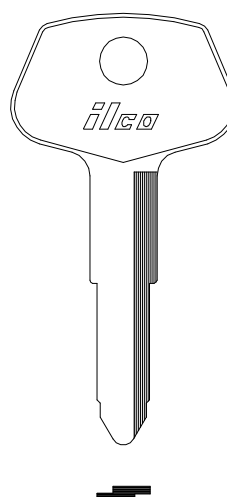
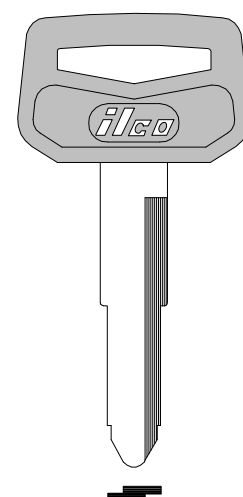
P1795
Y159

Y159-P
—

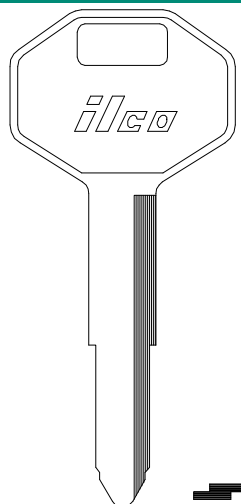
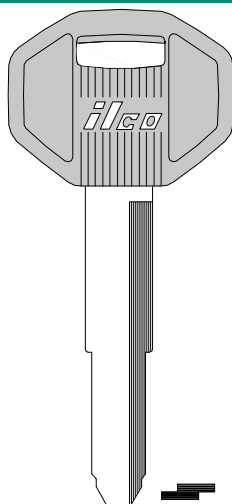
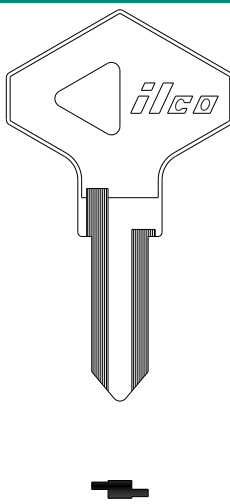
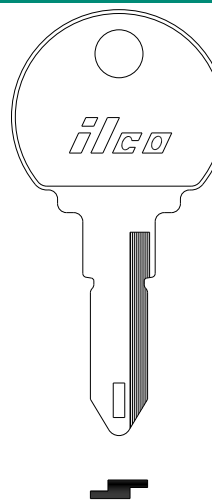
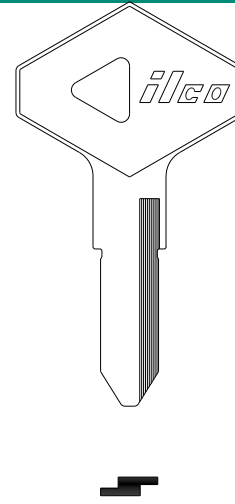
MS2
—

VALET FOR P1794 & Y157-P (-PC)

ILCO
EZ

CHRYSLER

MS13
—

X16
P1771CR

X17
S1771CR

X54
DC1

DC1-P
—

ILCO
EZ

CHRYSLER

X121
DC3

DC3-P (-PC)
—

X122
RN29

X147
RN30

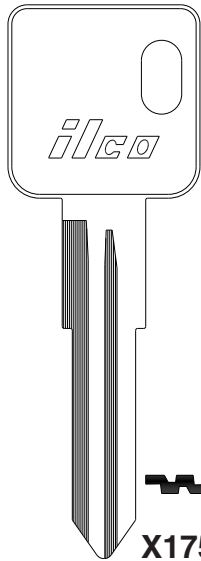
X171
RN31

ILCO
EZ

CHRYSLER

VEHICLE

sec 1 page 24



X175
RN32

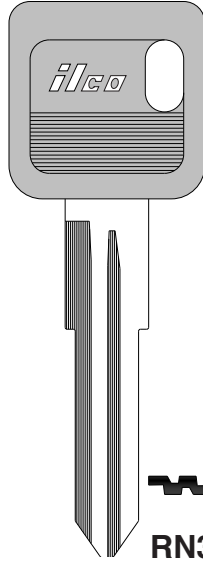

RN32-P
—

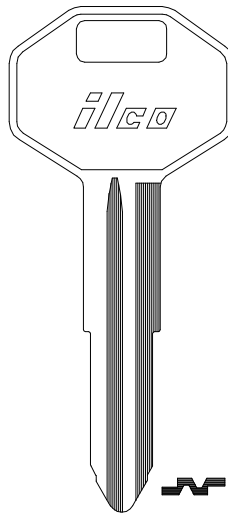

X176
MIT1

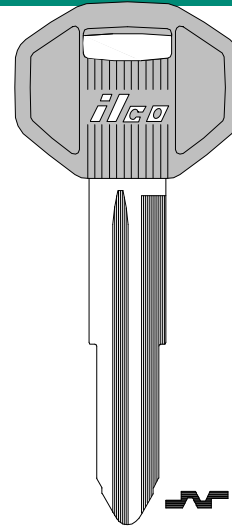

MIT1-P (-PC)
—

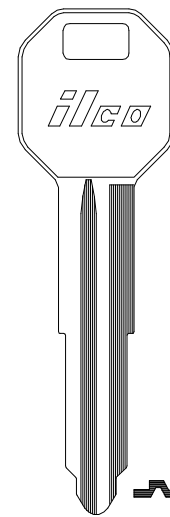

X213
MIT2

VALET FOR X176 & MIT1-P (-PC)

ILCO
EZ

CHRYSLER

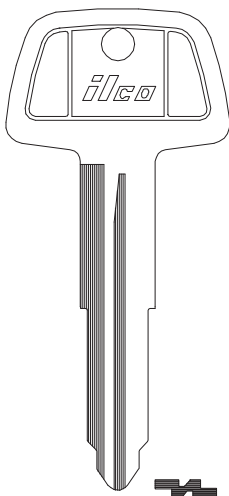

X224
MIT3

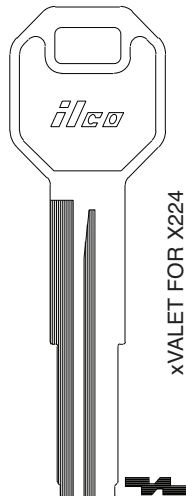

X229
MIT5

xVALET FOR X224

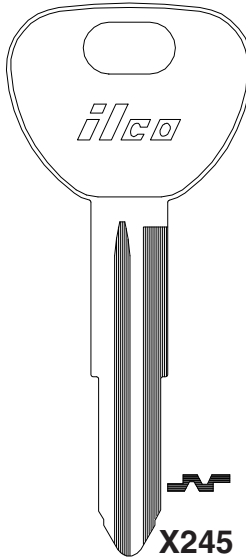

X245
MIT4

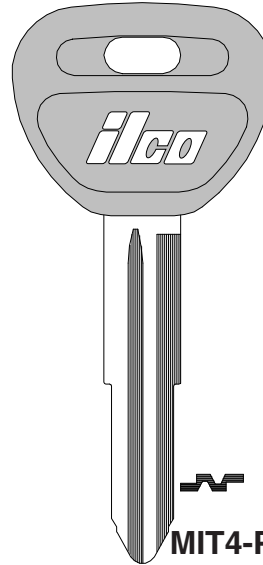

MIT4-P
—

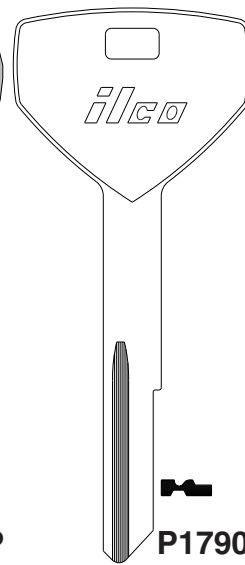

P1790TC
—

ILCO
EZ

CHRYSLER

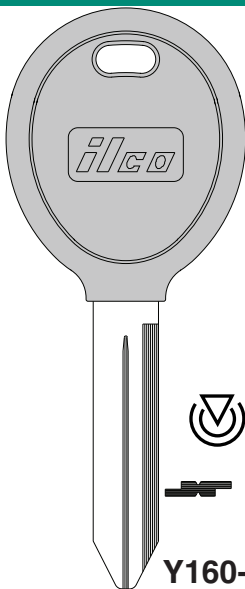

Y160-PT
—

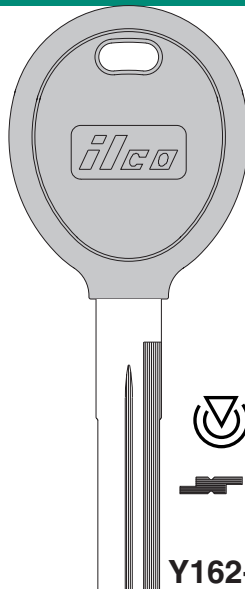

Y162-PT
—

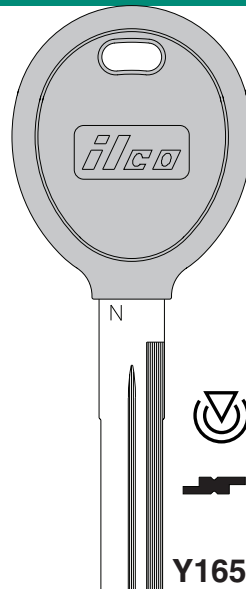

Y165-PT
—

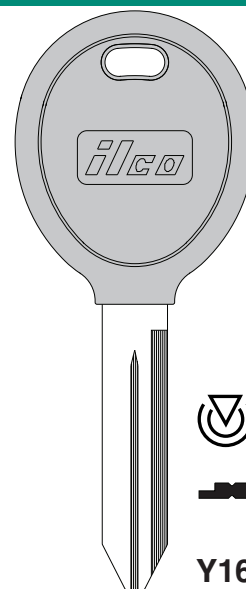

Y164-PT
—

ILCO
EZ

CHRYSLER

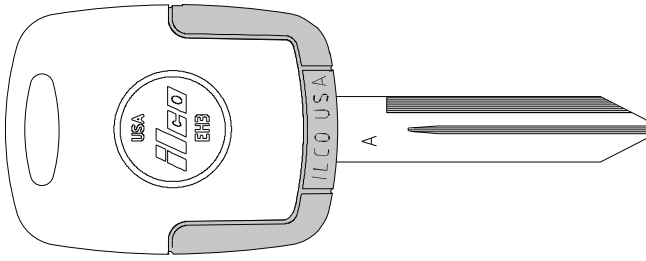

EH3
(Head Only)



EB3-A-Y160
(Blade Only)



Y160-EK3
(Complete Key)

ILCO
EZ

CHRYSLER

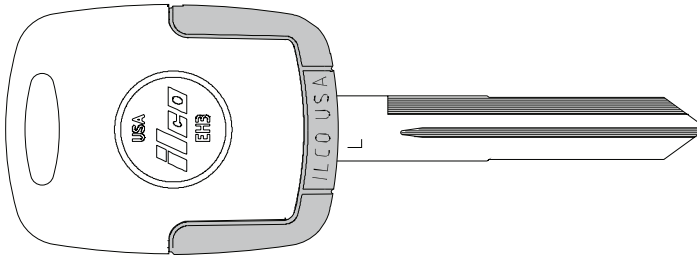

EH3
(Head Only)



EB3-L-MIT9
(Blade Only)



MIT9-EK3
(Complete Key)

ILCO
EZ

CHRYSLER

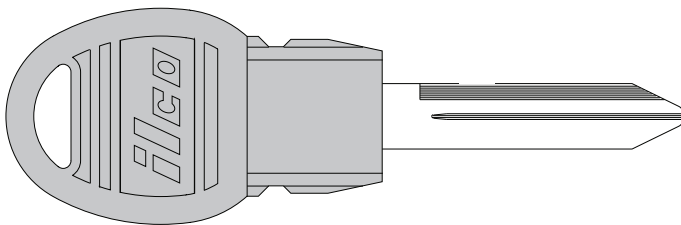

Y170-PT
—

ILCO
EZ

CHRYSLER

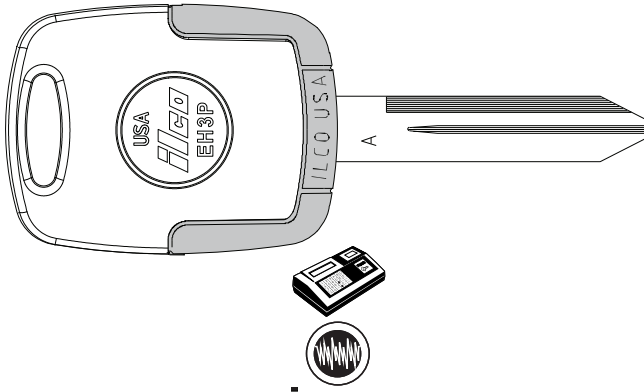

EH3P
(Head Only)

EB3-A-Y160
(Blade Only)

EK3P-Y164
(Complete Key)

ILCO
EZ

CHRYSLER

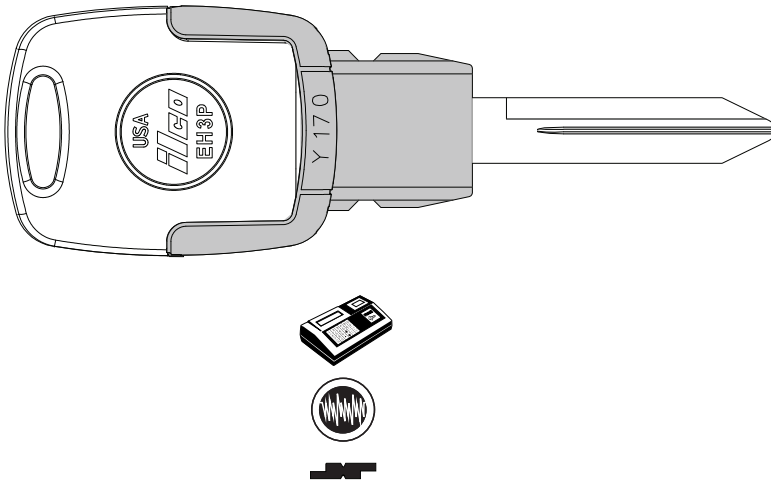

EH3P
(Head Only)



EB3-T-Y170
(Blade Only)

EK3P-Y170
(Complete Key)

ILCO
EZ

CHRYSLER OUTBOARDS

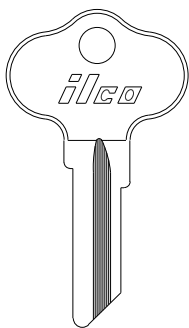
CITROEN





CH4 
CH8

CH5

CH6

CH3

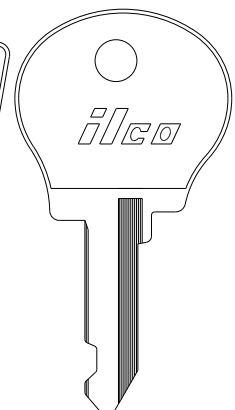
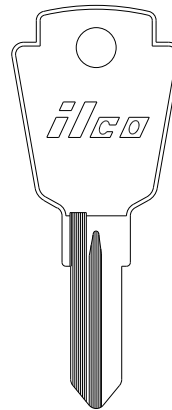
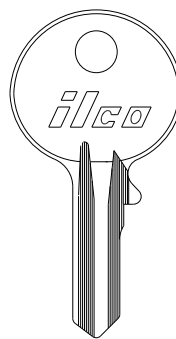
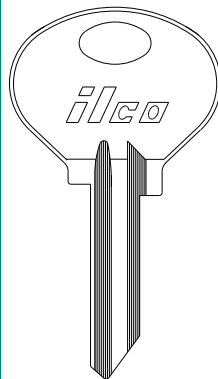
CH7



SM1

SM2

7DC



R7DC

SMS8

NE18

ILCO
EZ

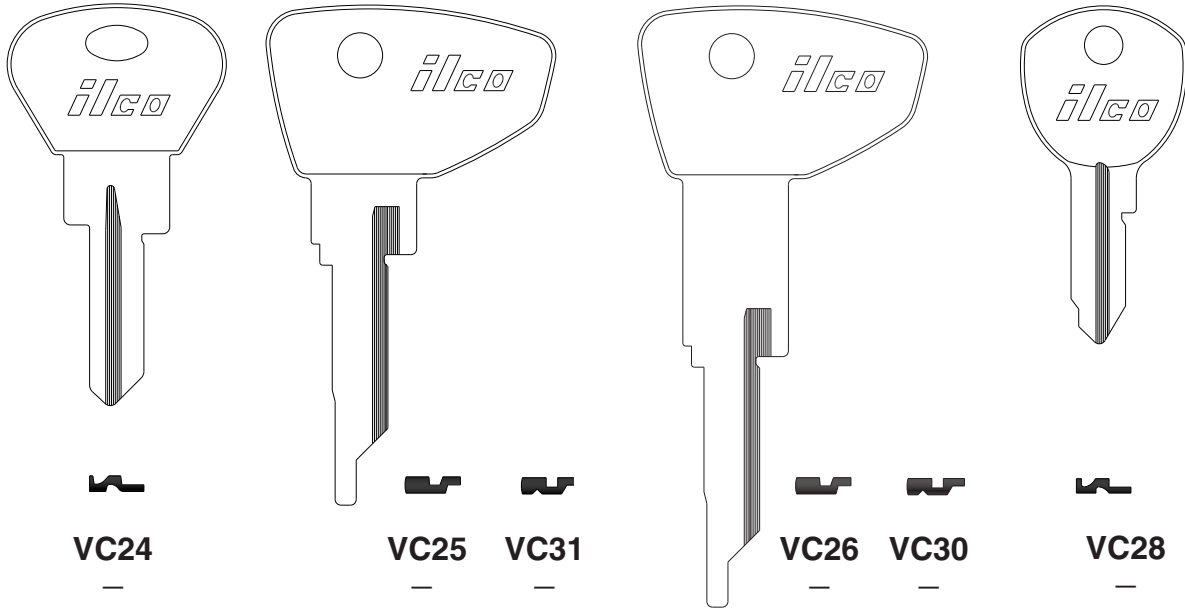
CITROEN



ILCO
EZ

CITROEN

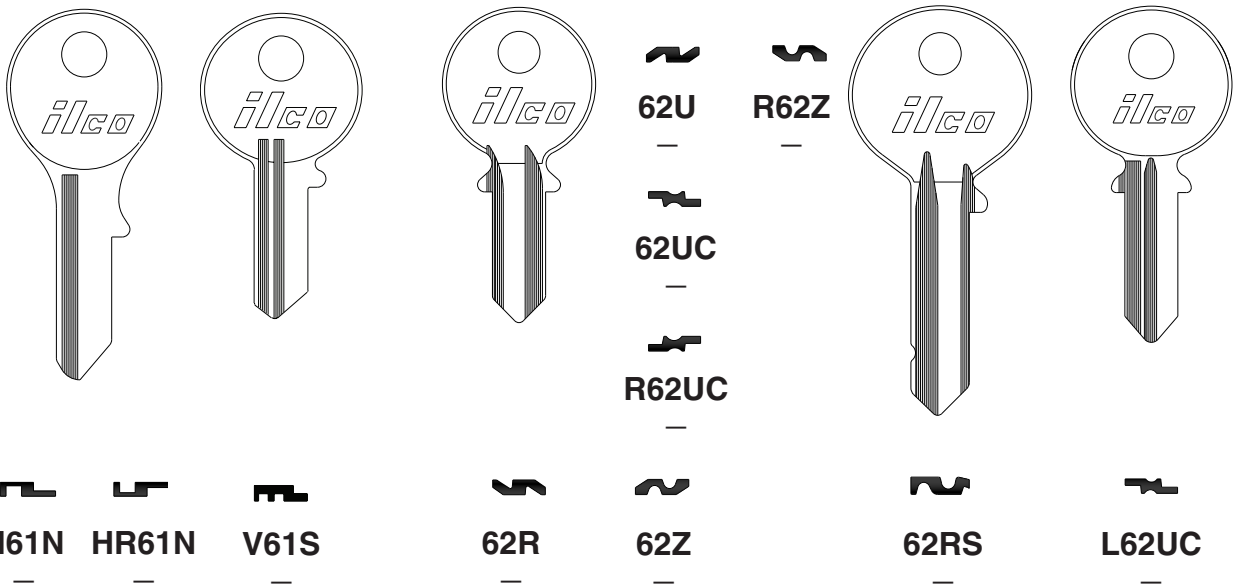

ILCO
EZ

CITROEN

THE CLUB

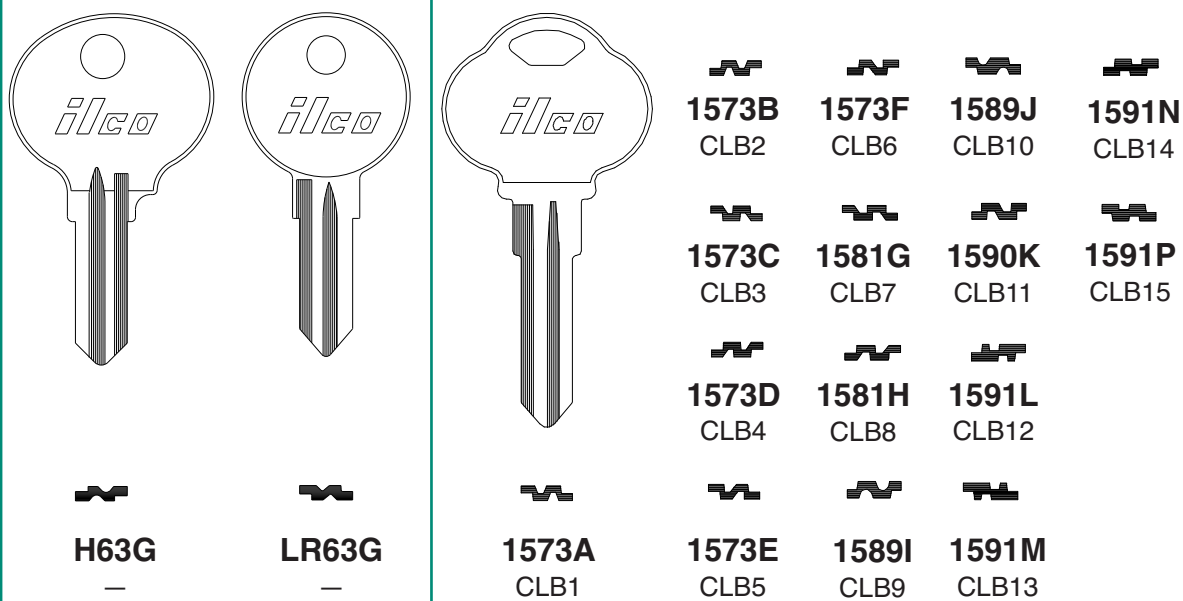

ILCO
EZ

CLUM INBOARD MOTORS

VEHICLE

sec 1 page 28

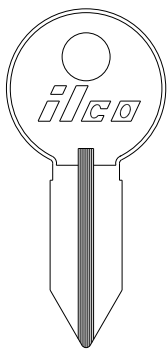

1040

—



1040A

—

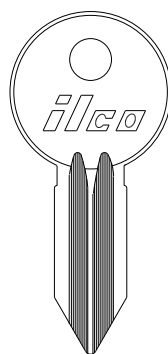

1040B

—

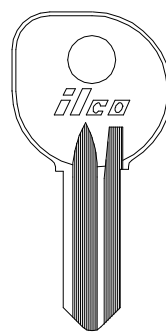

1040C

—



R1040C

—

ILCO
EZ

CLUM INBOARD MOTORS

COSMOPOLITIAN

D.A.F.

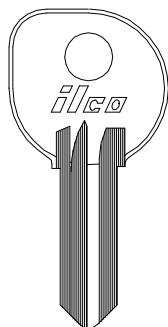

1040E

—

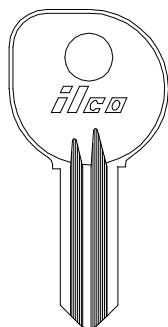

R1040E

—

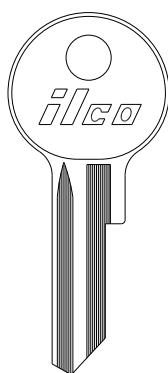

GE7

—

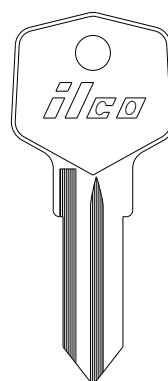

CA2

—

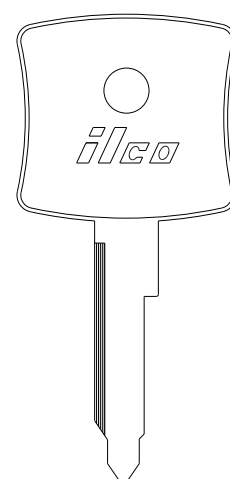

HF41

—

ILCO
EZ

D.A.F.

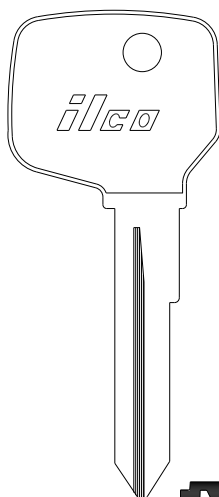

HF43

—

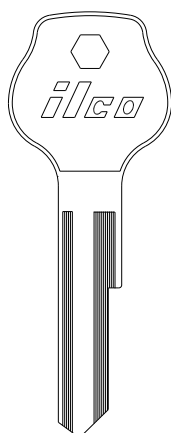

L62VA

—

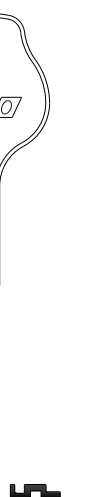

LR62VA

—

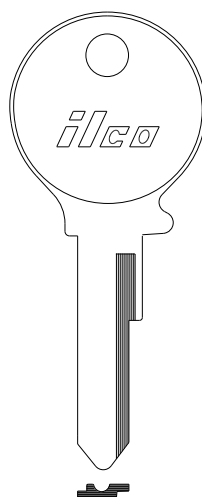

VW64T

—

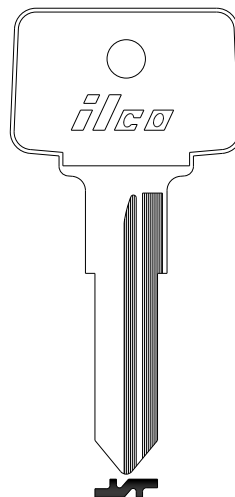

X81

HF46

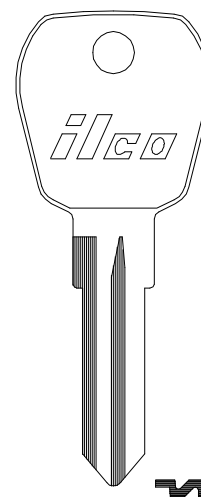

X86

FC7

ILCO
EZ

D.A.F.

D. K. W.

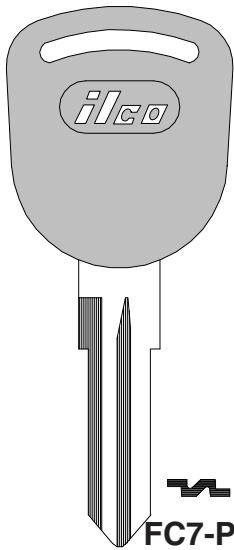

FC7-P

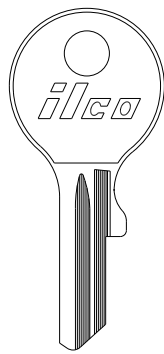

BU1

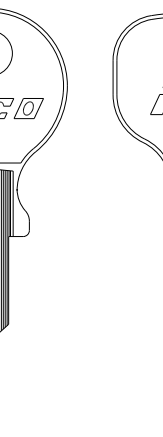

BU2

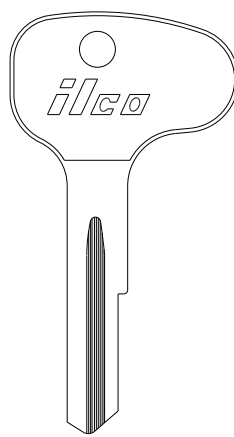

PR1

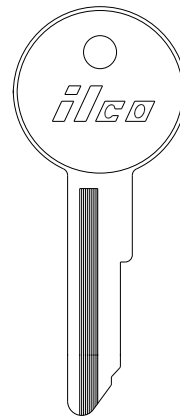

WT1

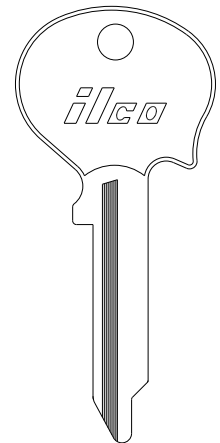

NE2

ILCO
EZ

D. K. W.

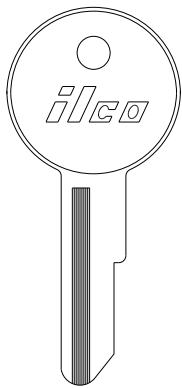

WT2



DK3

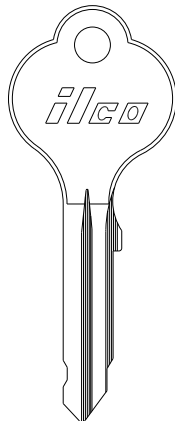

YM3

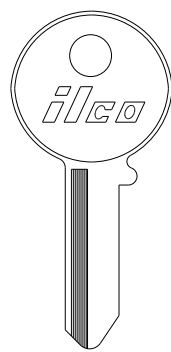

61N



61NA

-



R61NA

-

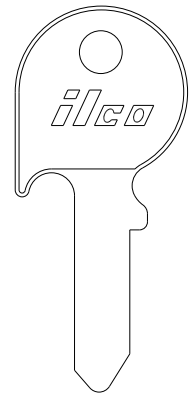

H61NA



HR61NA

ILCO
EZ

D. K. W.

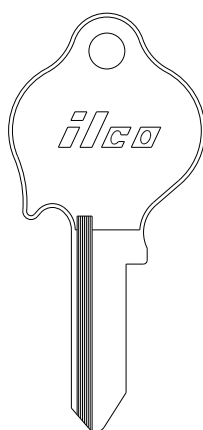

H61VM

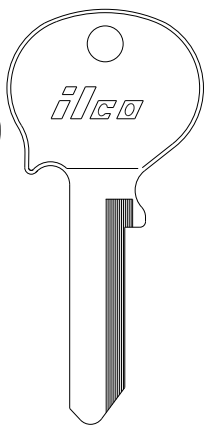

H61VO

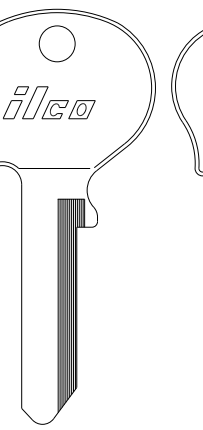

H61VR

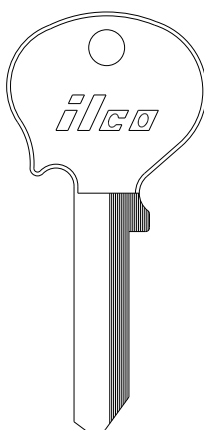

R61N

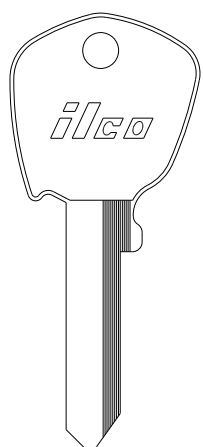

T61VR

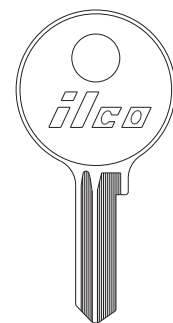

62VG

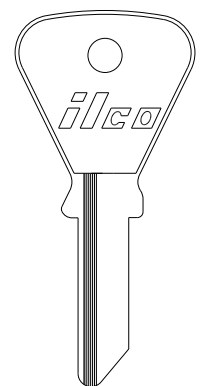

62VH

ILCO
EZ

DAEWOO

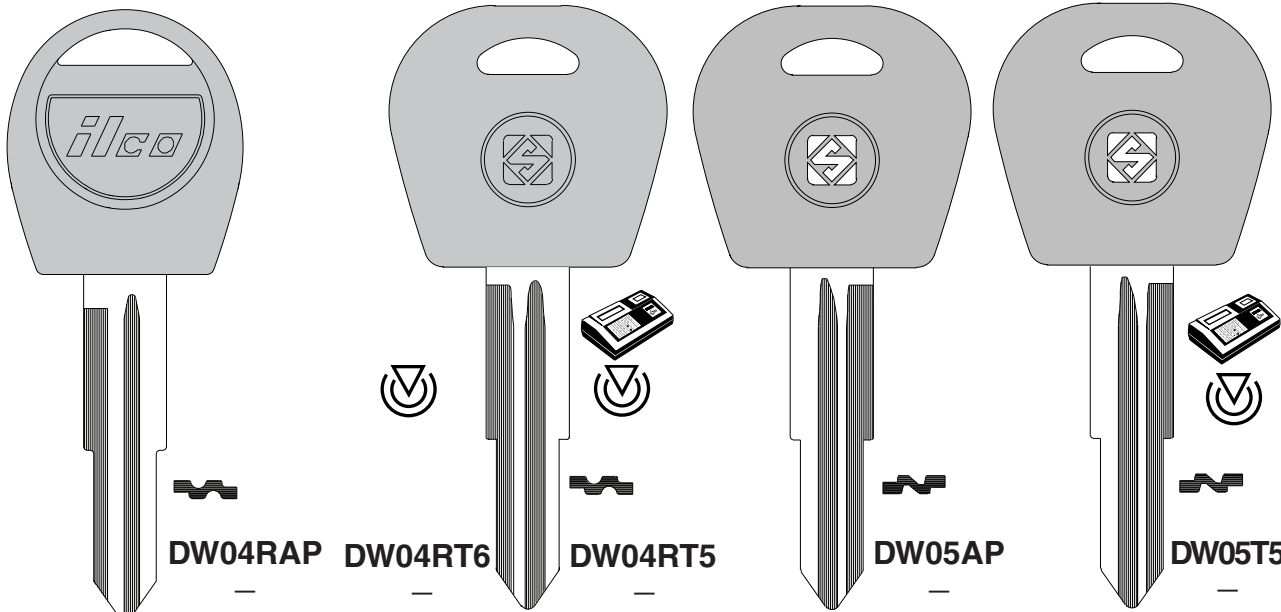
 ILCO
EZ

DW04RAP

DW04RT6

DW04RT5

DW05AP

DW05T5

DAIHATSU

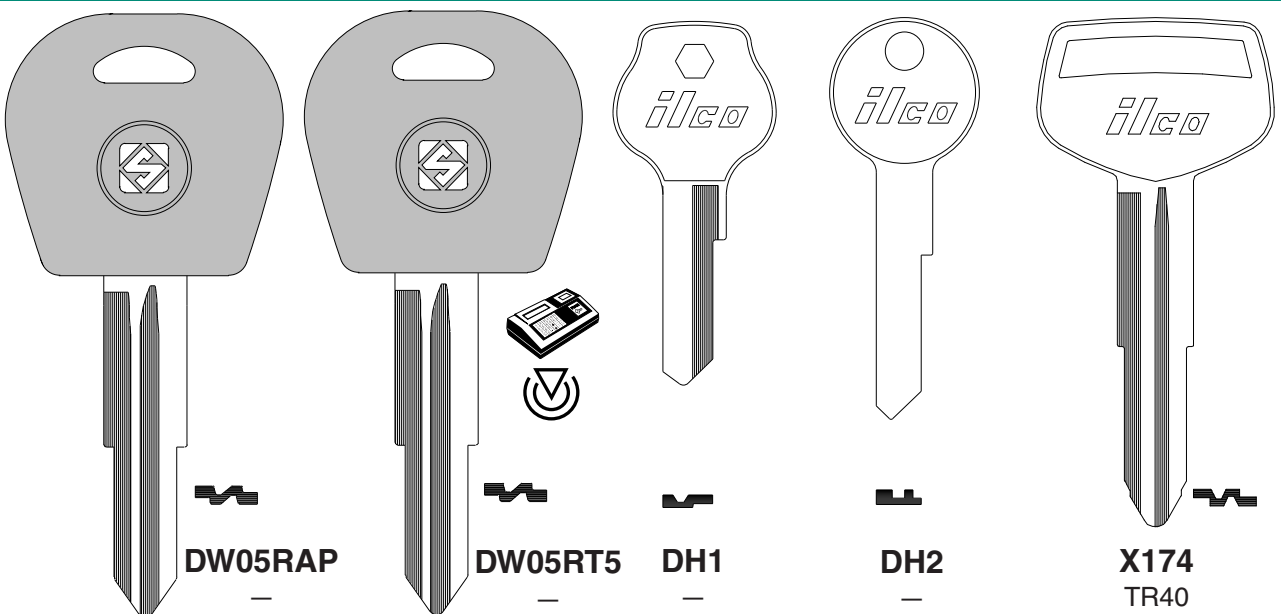
 ILCO
EZ

DW05RAP

DW05RT5

DH1

DH2

 X174
TR40

DAIHATSU

DATSUN

DENZAL

DERBI

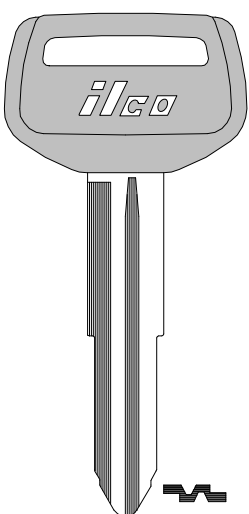
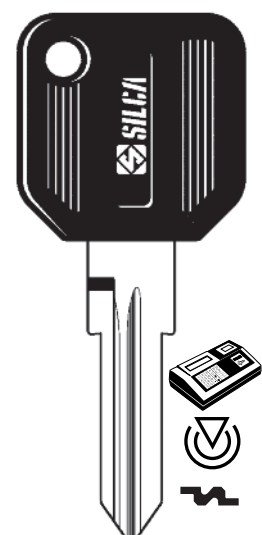
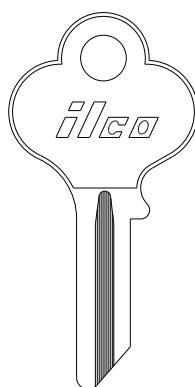
 SEE
NISSAN

 ILCO
EZ

TR40-P (-PC)

FV1

ZD24RDP-SI

GT15RDT5-SI

DERBI DIAMOND REO DODGE DUCATI

X270
TMC1

1098M
B1

SEE CHRYSLER

KW14P
—

KW17T5-SI
—

ILCO
EZ

DUCATI EAGLE ESCURRA EVINRUDE MOTORS

X259
KW14

SEE CHRYSLER

ES1 **ES1R**
— —

OM10
—

1041G
CG1

ILCO
EZ

EVINRUDE MTRS FERRARI

1041GA
CG2

GT2 **GT3**
— —

LN4
—

NE8
—

FT37 **FT38**
— —

ILCO
EZ

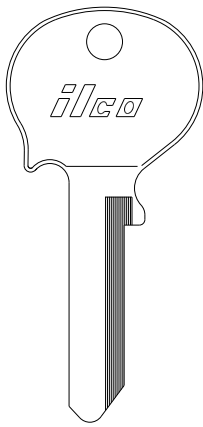
FERRARI
FIAT

H61VR
—

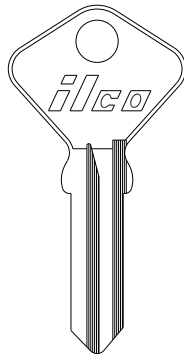

F91C
—

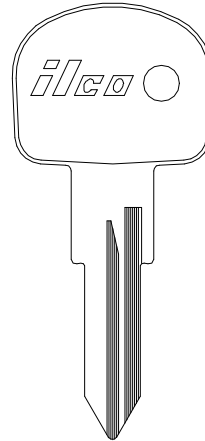

X152
FT46

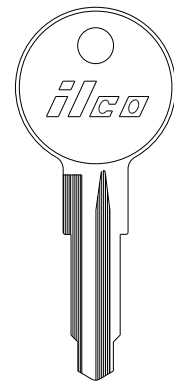

FS1
—

ILCO
EZ

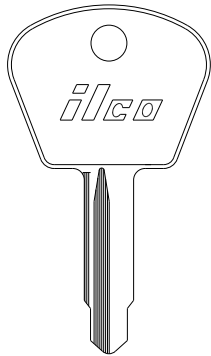
FIAT

SP1
—

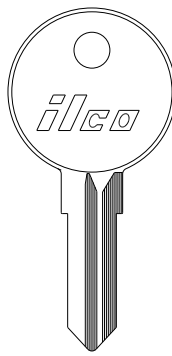

TR1
—

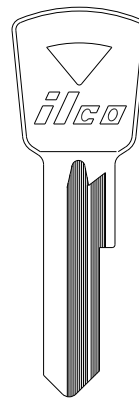

WS1
—

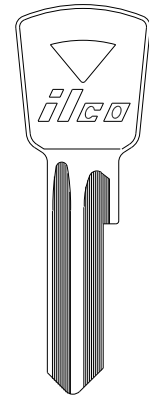

WS2
—

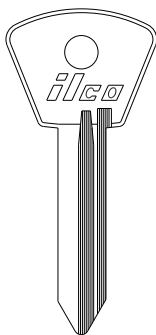

ILCO
EZ

FIAT

AL3
—

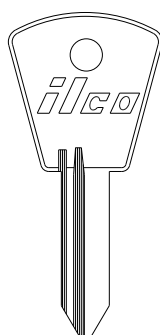

AL4
—

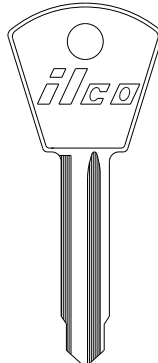

SP5
—

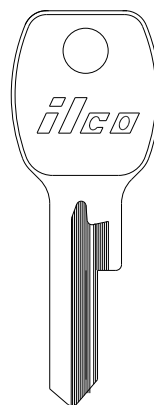

WS5
—

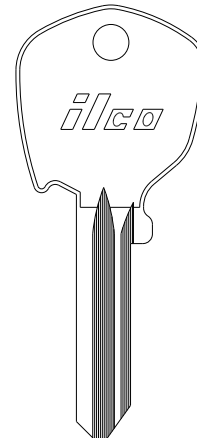

FT6
—

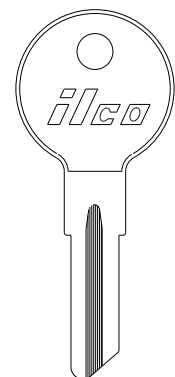

FT6R
F81E

ILCO
EZ

LA6
—

FIAT

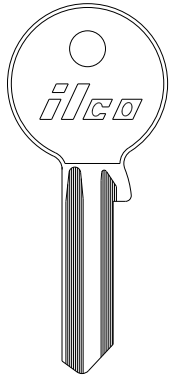

WS6
—

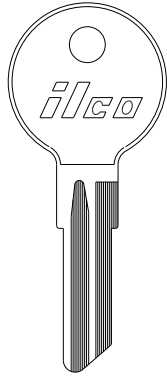

LA7
—

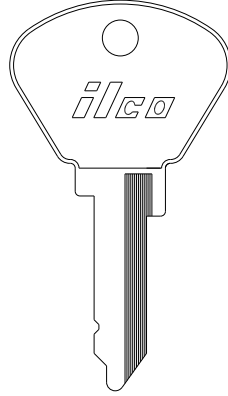

NE9
—

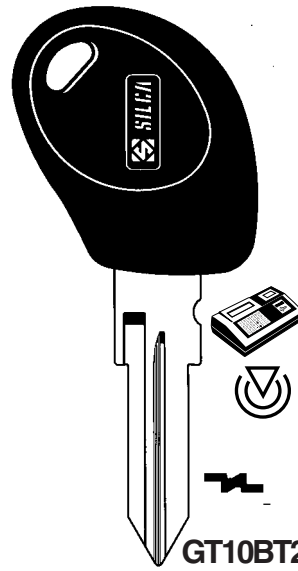

GT10BT2/5
—

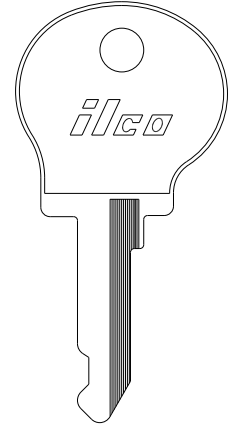

NE13
—

ILCO
EZ

FIAT

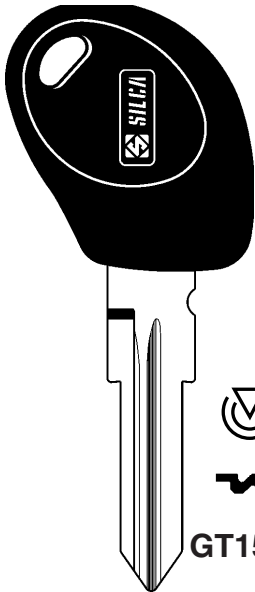

GT15RBT2/5
—

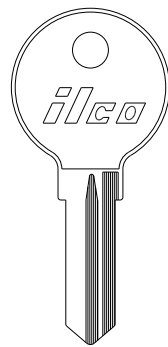

F22
—

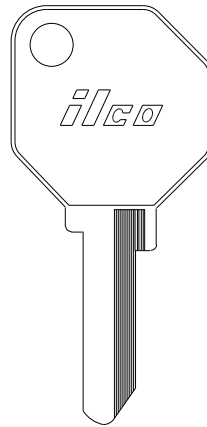

NE23
—

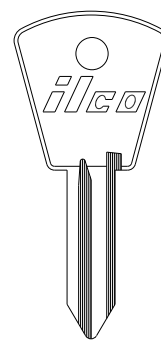

F33
—

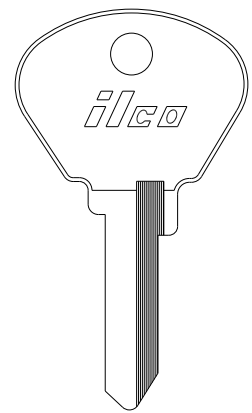

F44
—

ILCO
EZ

FIAT

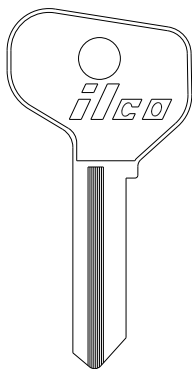

F54
—

FT37
—
FT38
—

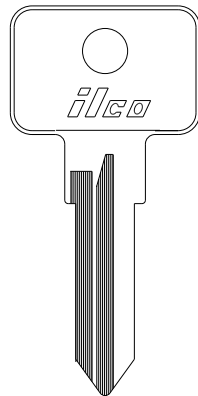

NE54
—

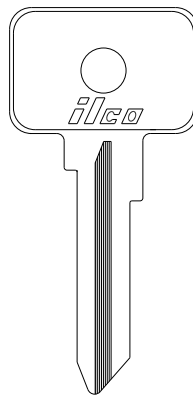

NE55
—

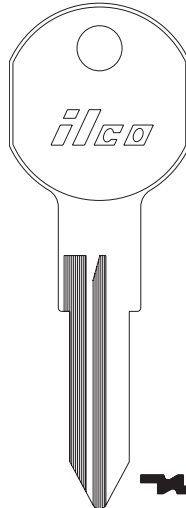

NE56
—

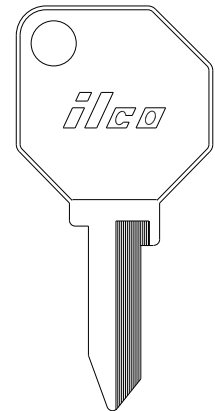

NE57
—

ILCO
EZ

FIAT

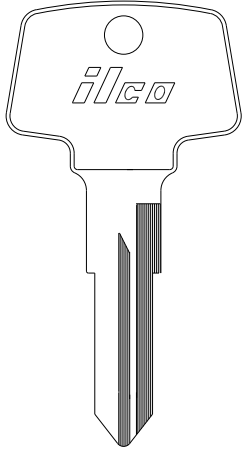

NE59

-

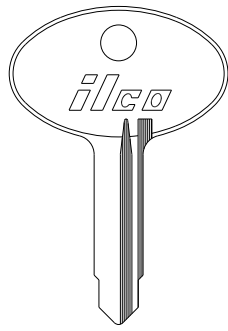

61D

-



R61D

-



61E

-



61TS

-



R61E

-



R61TS

-

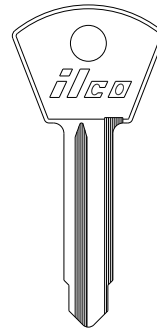

61F

-

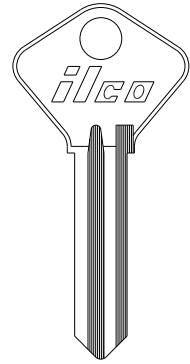

61G

-



R61G

-

 ILCO
EZ

FIAT

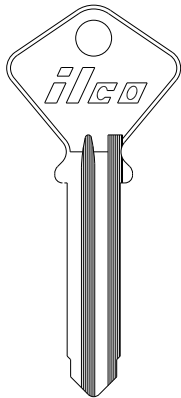

61GA

-

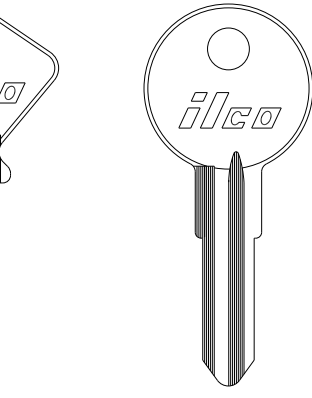

R61GA

-

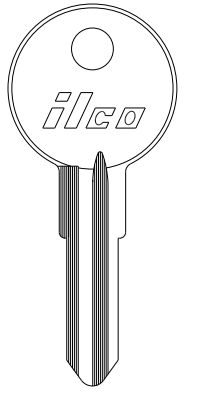

61H

-

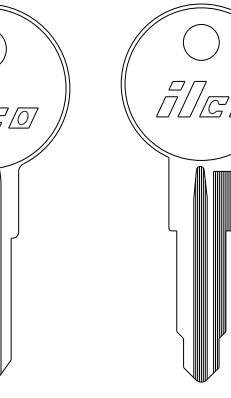

R61H

-

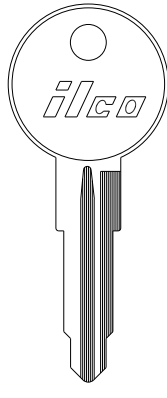

61J

-

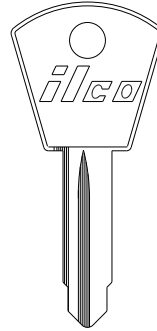

DR61F

-

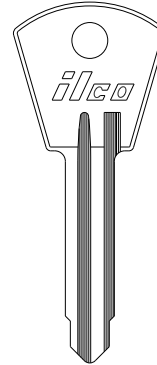

H61G

-

L61D

-

LR61D

-

 ILCO
EZ

FIAT

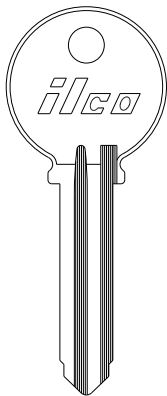

L61G

-

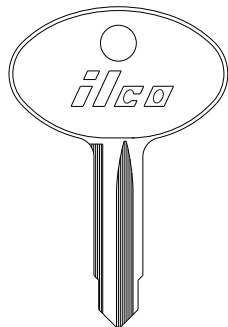

LR61G

-

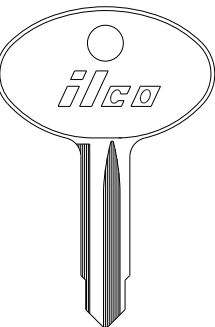

R61ST

-

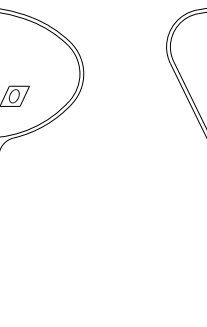

R62TS

-

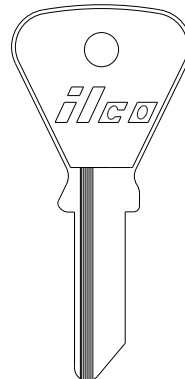

62VH

-

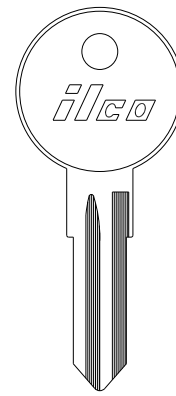

Y62

-

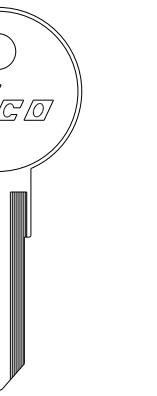

YR62

-

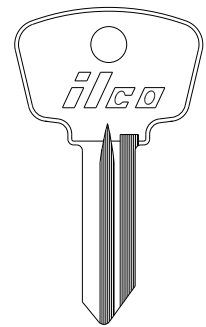

63SP

-

R63SP

-

 ILCO
EZ

FIAT



63ST	R63ST	63TS	R63H	R63TS	64S
—	—	—	—	—	—

ILCO
EZ

FIAT

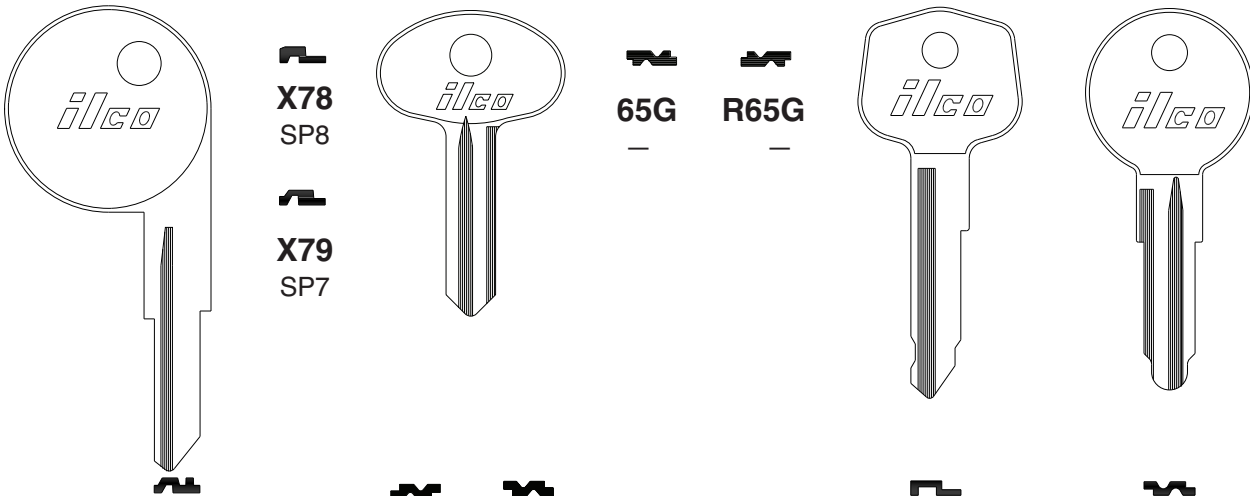

X64	X78	65G	R65G	65FA	R65FA	65M	66A
SP6	SP8	—	—	—	—	—	—
	X79						
	SP7						

ILCO
EZ

FIAT

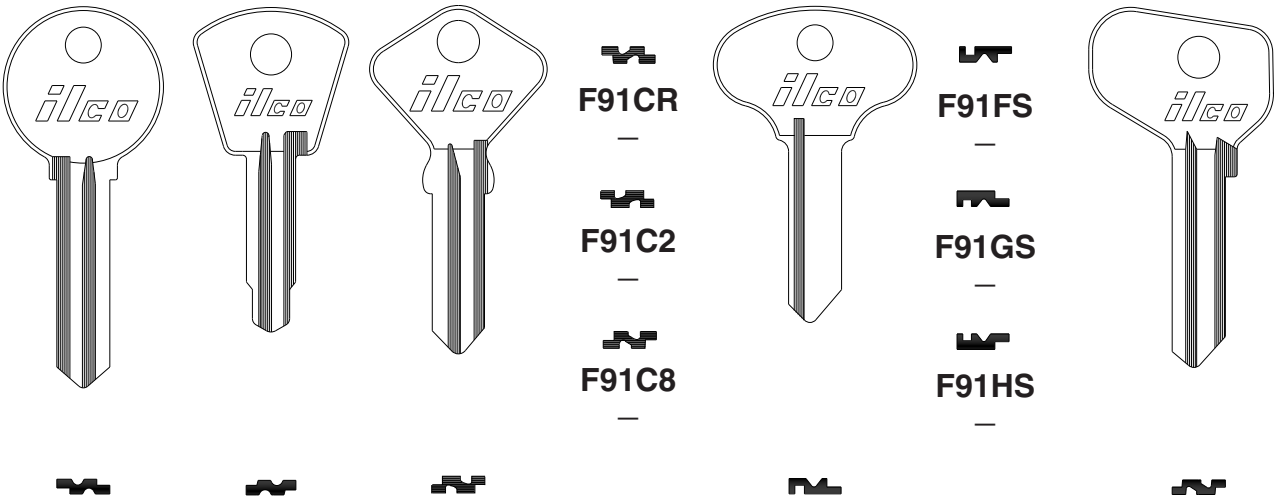

66BB	F66C	F91C	F91CR	F91ES	F91FS	X99
—	—	—	—	—	—	—
			F91C2		F91GS	
			—		—	
			F91C8		F91HS	
			—		—	

ILCO
EZ

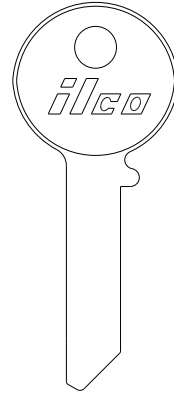
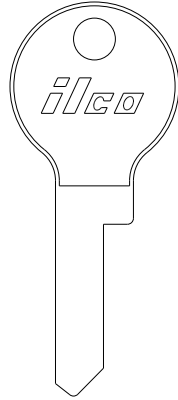
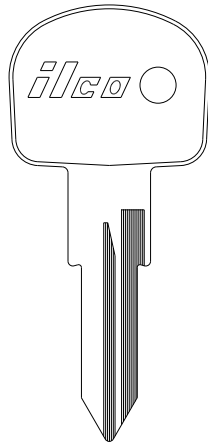
FIAT
FORD

ILCO
EZ

X109
FT43

X113
—

X152
FT46

1125
H6

1125A
—

1125D
—

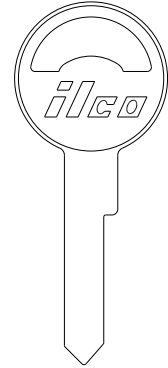
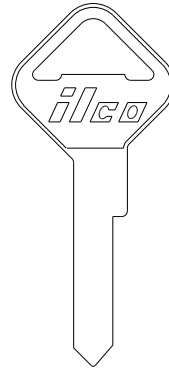
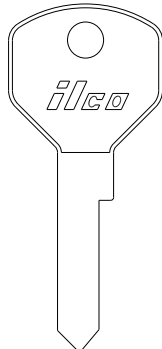
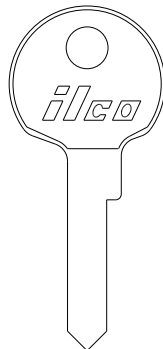
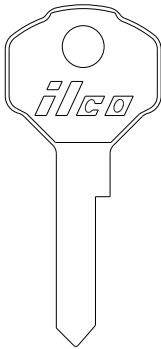
FORD

ILCO
EZ

1125F
—

1125G
—

1125H
H5

1125K
—

1125M
—

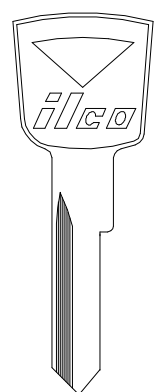
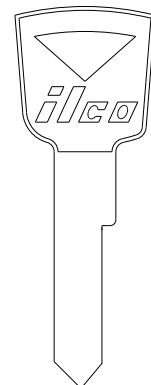
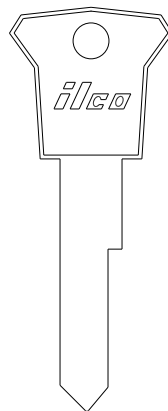
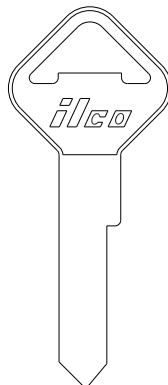
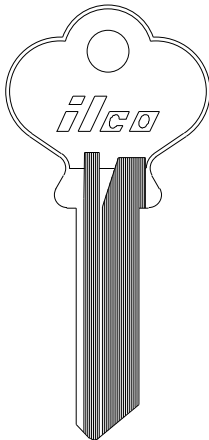
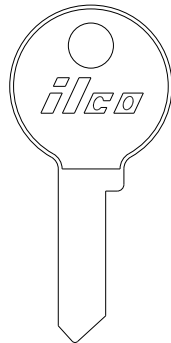
FORD

ILCO
EZ

D1125
—

1126M
—

1127
—

1127B
—

1127D
—

1127DP
H27

FORD

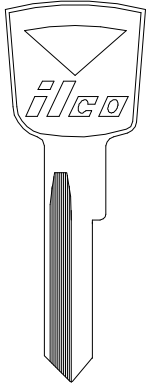

1127DU
H18

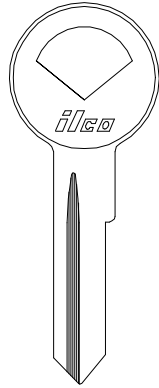

1127ES
H26

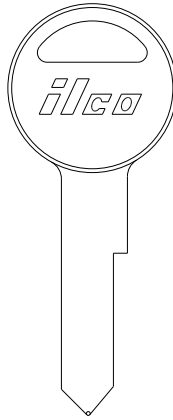

1127F
—

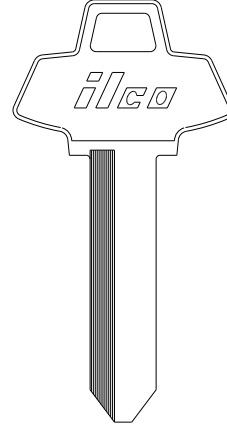

1127FD
—

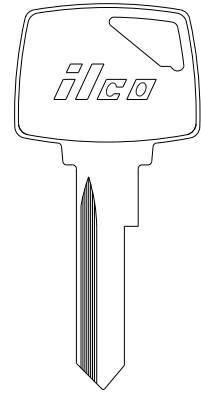

1127FL
—



ILCO
EZ

FORD

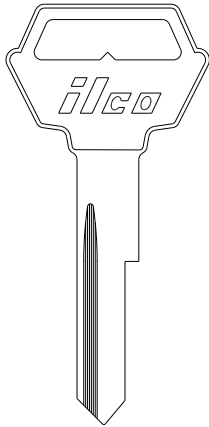

1127FR
—

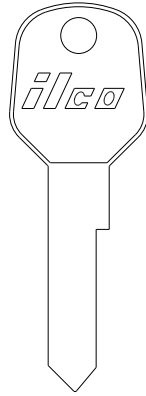

1127H
—

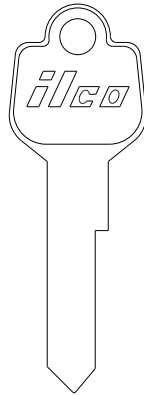

1127J
—

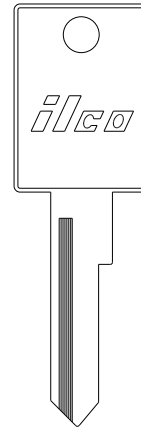

1127K
—

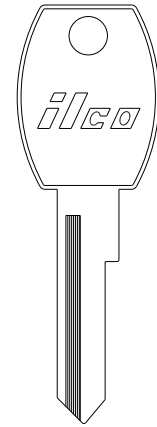

1127L
—



ILCO
EZ

FORD

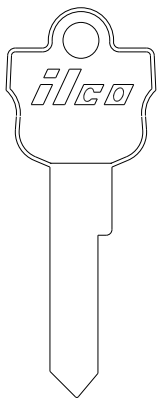

1127M
—

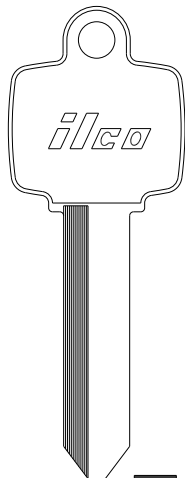

1127ME
—

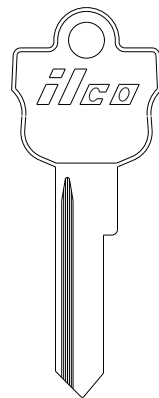

1127MP
—

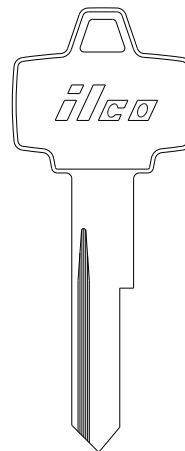

1127MU
—

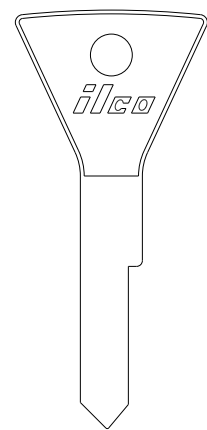

1127N
—

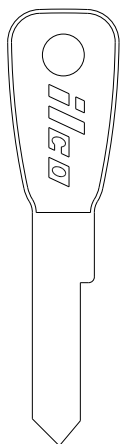

ILCO
EZ

FORD**1127P**

—

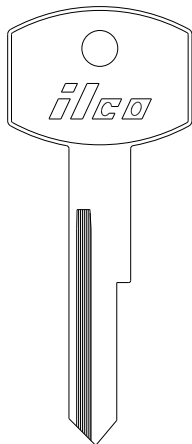
**1127T**

—

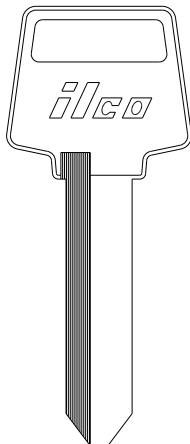
**1127TB**

—

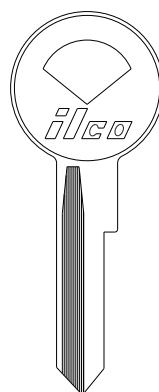
**M1127A**

—

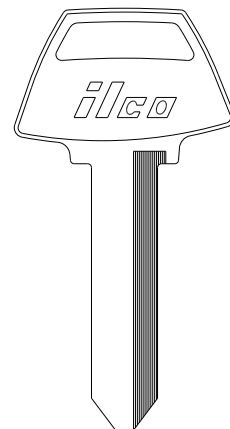
**S1127FD**

—

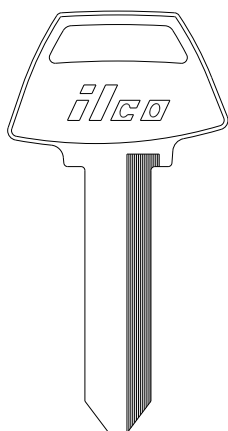
**ILCO
EZ****FORD****S1127FL**

—

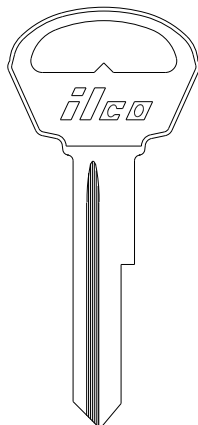
**S1127FR**

—

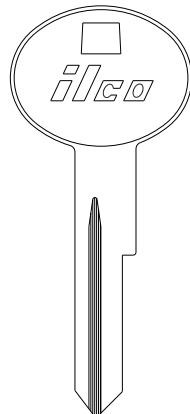
**S1127LC**

—

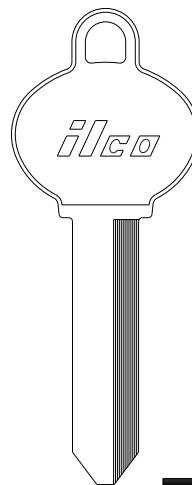
**S1127ME**

—

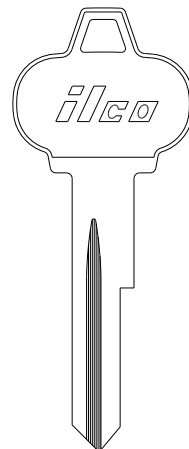
**S1127MU**

—

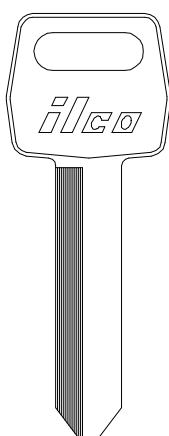
**ILCO
EZ****FORD****1167FD**

H51

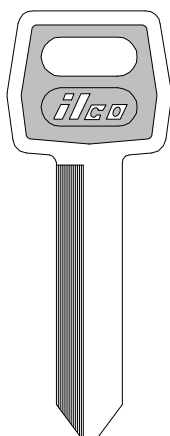
**H51-PC**

—

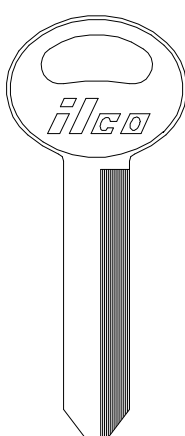
**S1167FD**

H50

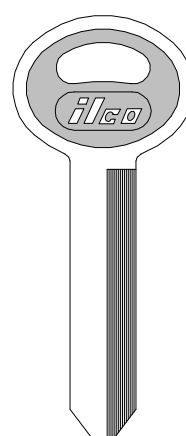
**H50-PC**

—

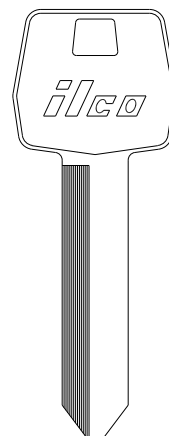
**1170LN**

—

**ILCO
EZ**

FORD

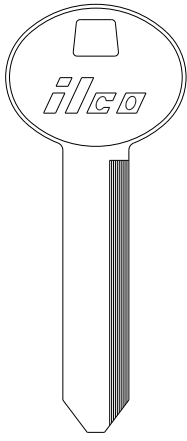

S1170LN
—

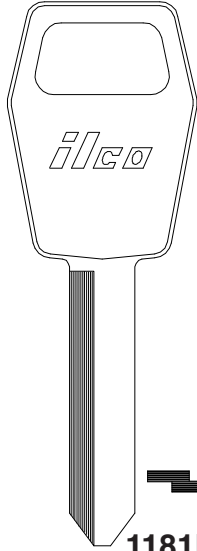

1181FD
H53

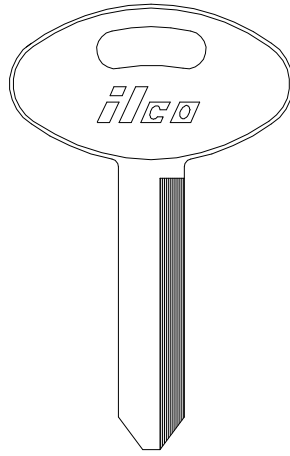

S1181FD
H52

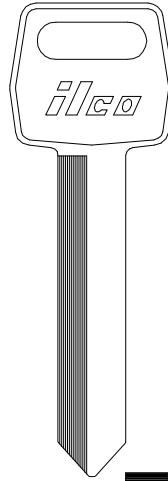

1184FD
H54

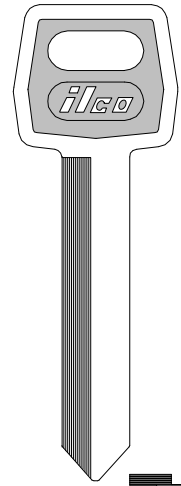

H54-PC
—

ILCO
EZ

FORD

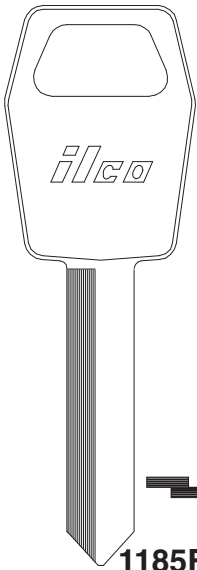

1185FD
H55

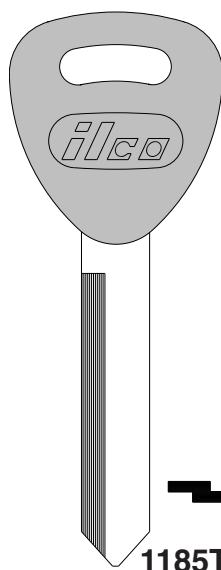

1185T-P
—

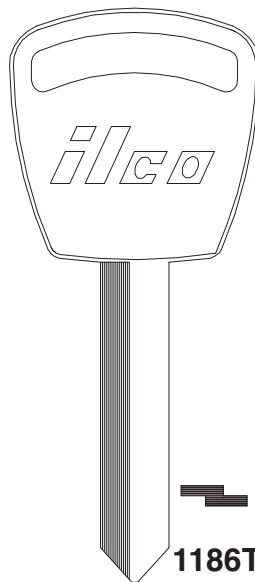

1186TS
H56

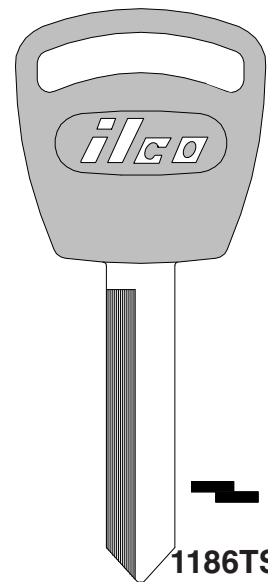

1186TS-P
—

ILCO
EZ

FORD

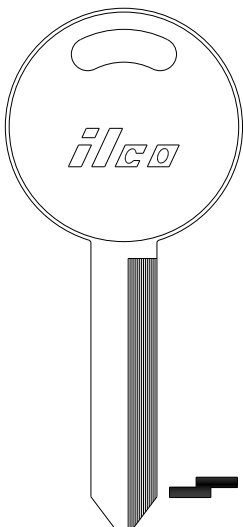

S1186TS
—

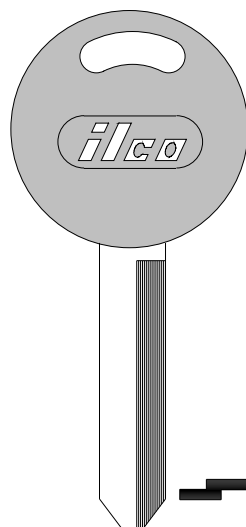

S1186TS-P
—

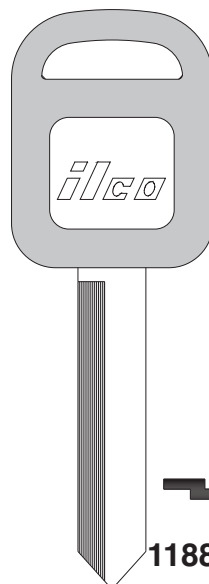

1188LN-P
—

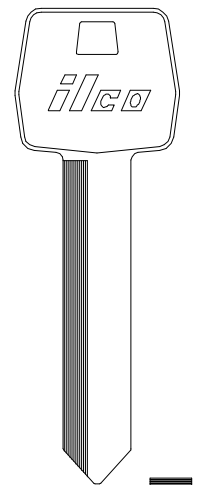

1190LN
H60

ILCO
EZ

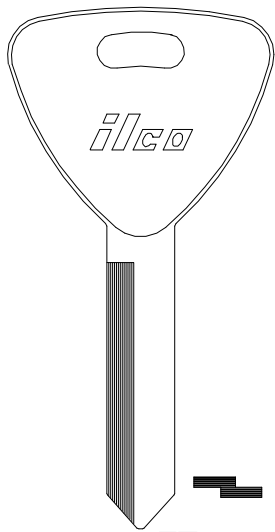
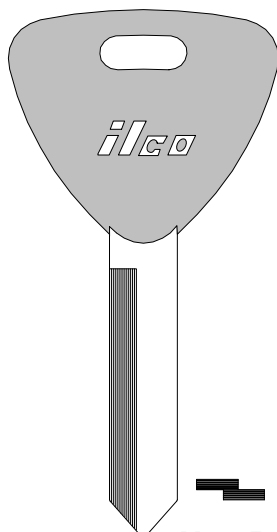
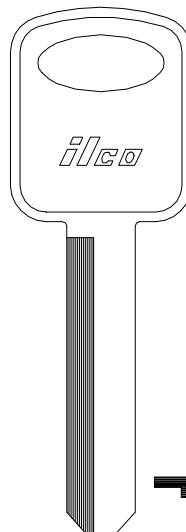
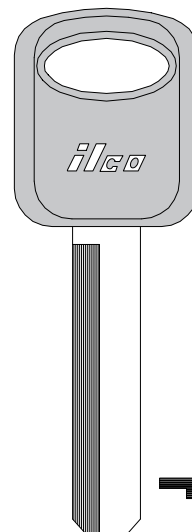
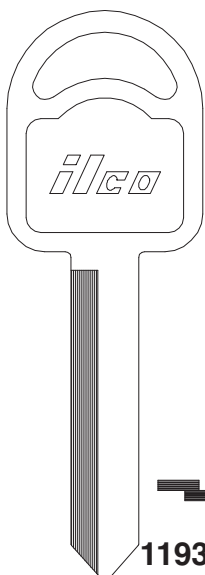
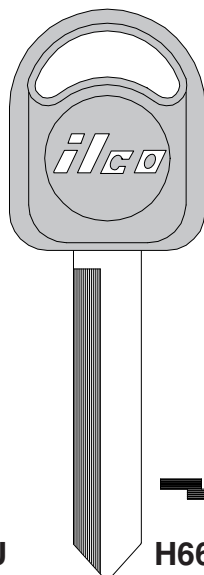
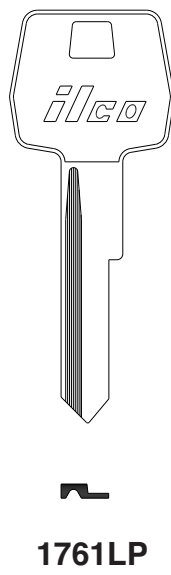
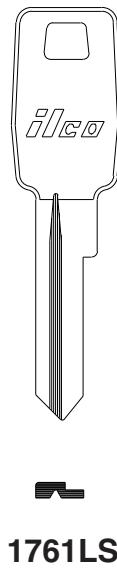
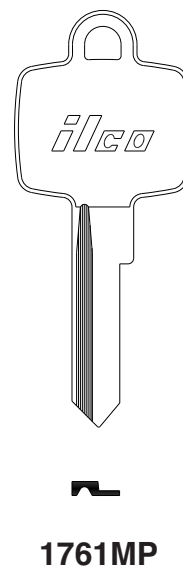
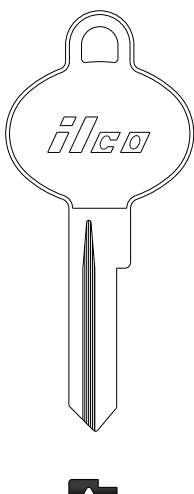
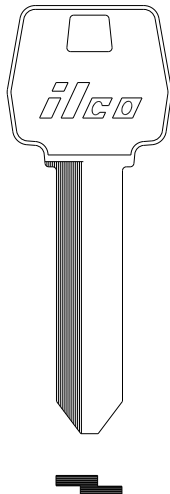
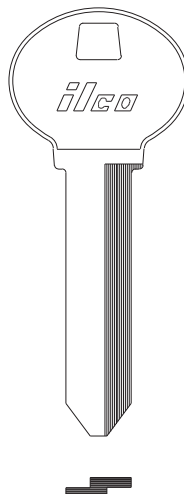
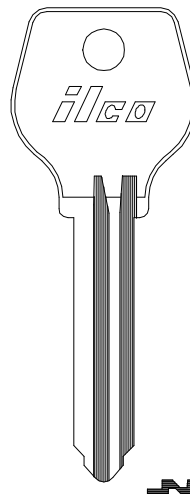
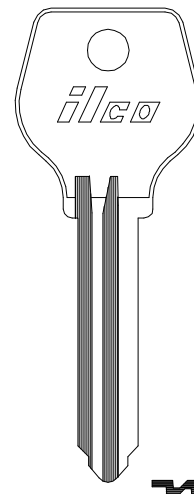
FORD**1191ET**
H62**H62-P**
—**1193FD**
H67**H67-P (-PC)**
—**ILCO**
EZ**FORD****1193MU**
H66**H66-P**
—**1761LP**
—**1761LS**
—**1761MP**
—**ILCO**
EZ**FORD****1761MS**
—**1766LN**
—**S1766LN**
—**X4**
MZ4**X5**
MZ5**ILCO**
EZ

FORD

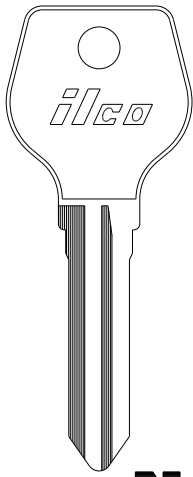

X26
MZ9

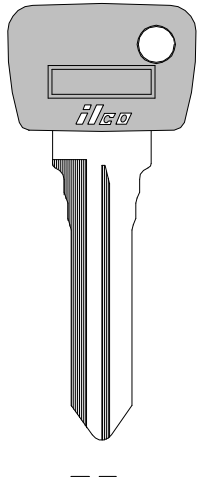

MZ9-P
—

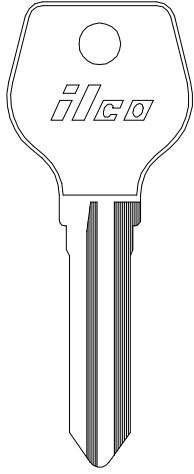

X27
MZ10

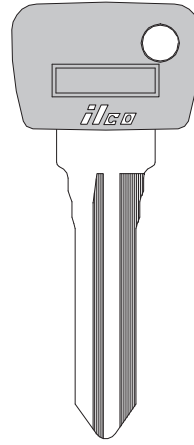

MZ10-P
—

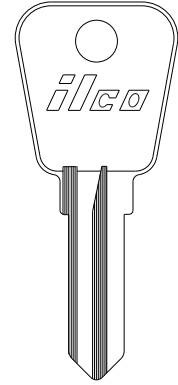

62FT
F68YT

ILCO
EZ

FORD

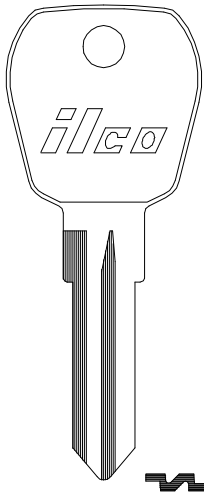

X86
FC7

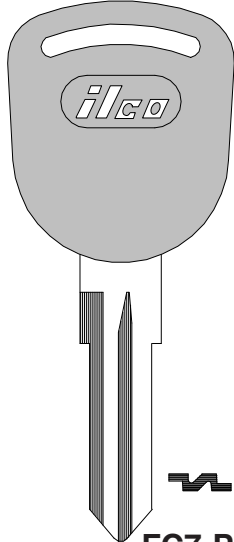

FC7-P
—

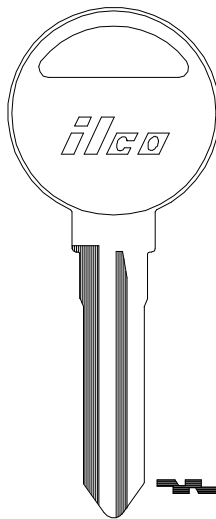

X131
MZ13

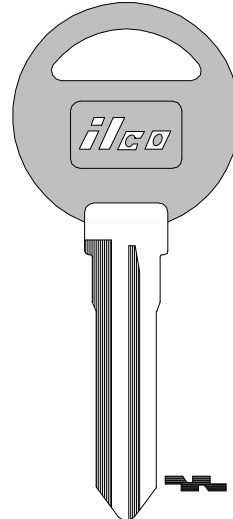

MZ13-P (-PC)
—

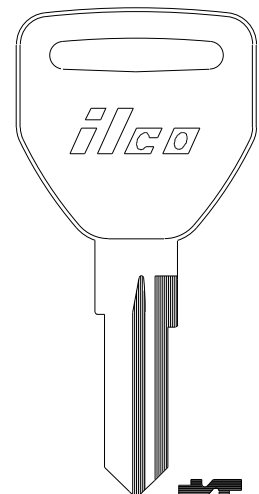

X169
WB3

ILCO
EZ

FORD

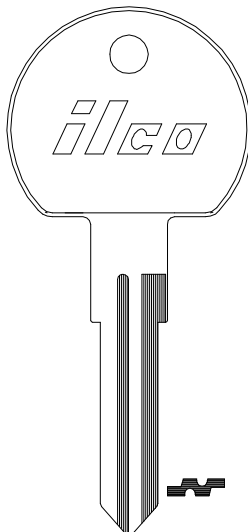

X170
NE48

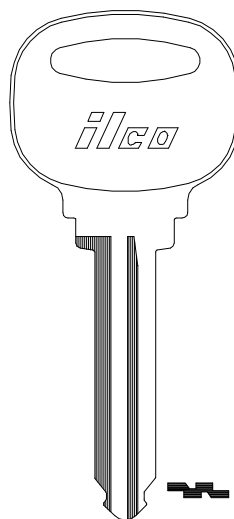

X202
H59

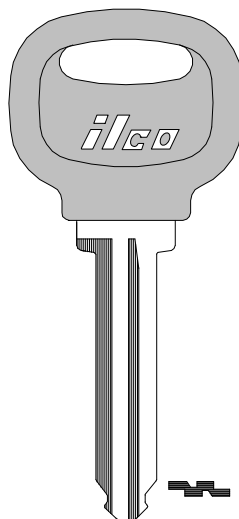

H59-P (-PC)
—

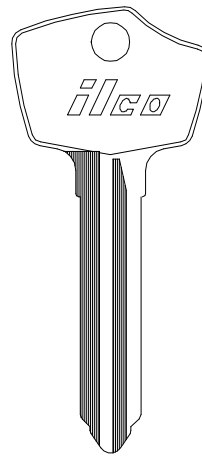

X207
H63

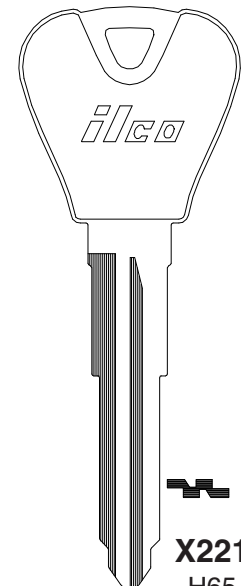

X221
H65

ILCO
EZ

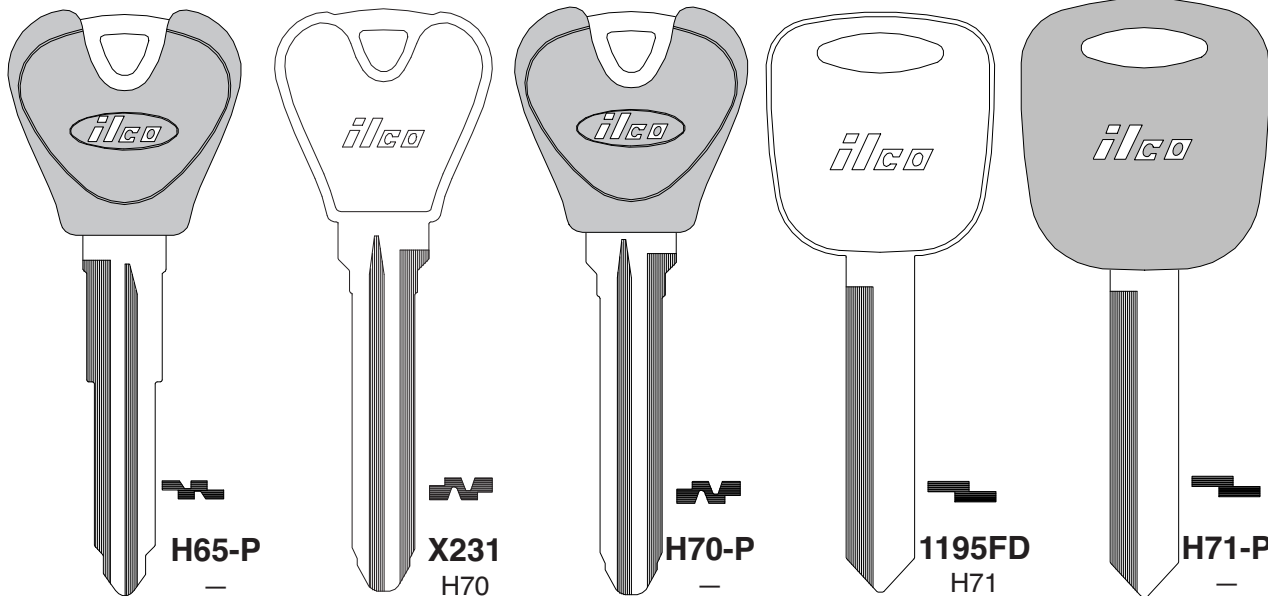
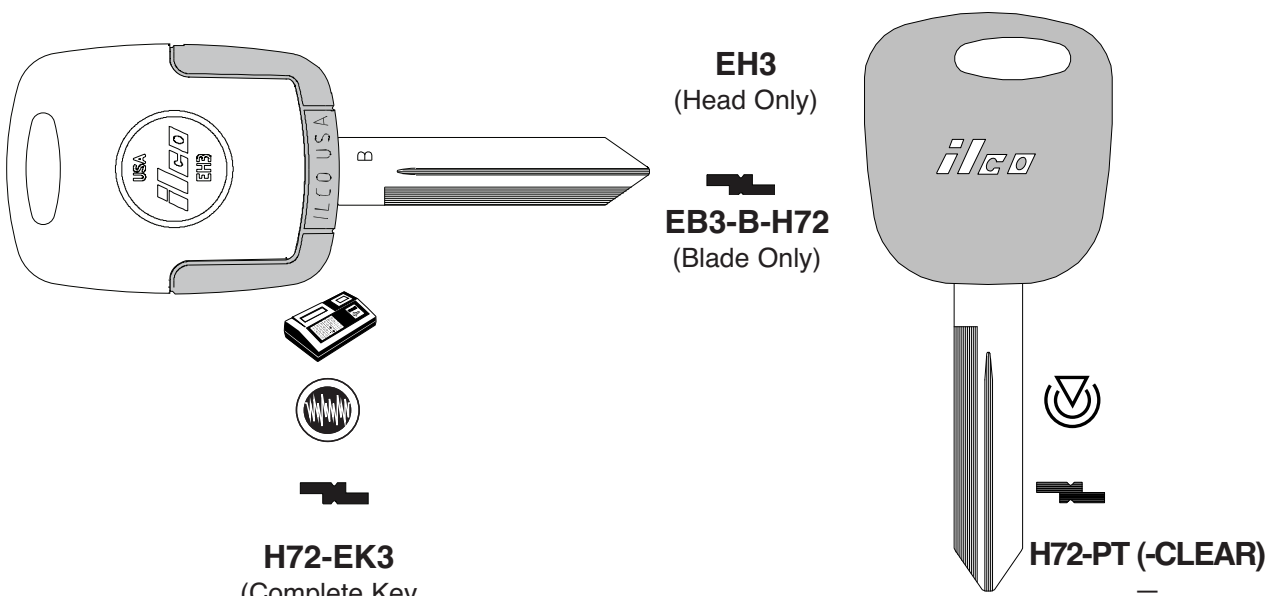
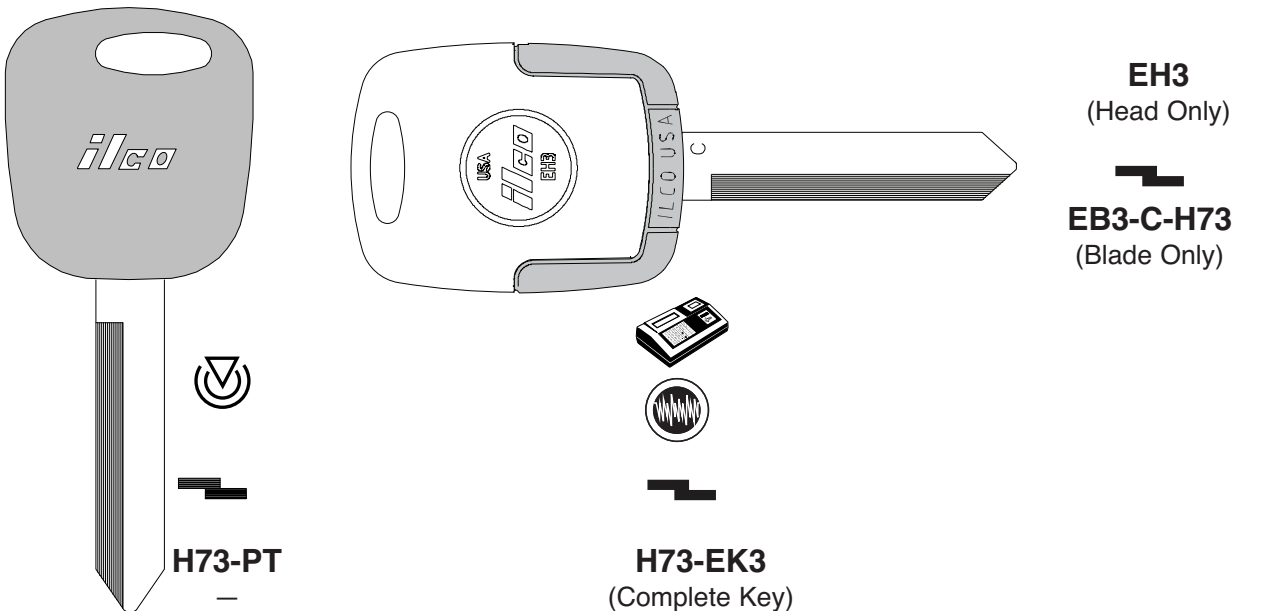
FORD**ILCO**
EZ**H65-P**
—**X231**
H70**H70-P**
—**1195FD**
H71**H71-P**
—**FORD****ILCO**
EZ**H72-EK3**
(Complete Key)**EH3**
(Head Only)**EB3-B-H72**
(Blade Only)**H72-PT (-CLEAR)**
—**FORD****ILCO**
EZ**H73-PT**
—**H73-EK3**
(Complete Key)**EH3**
(Head Only)**EB3-C-H73**
(Blade Only)

FORD

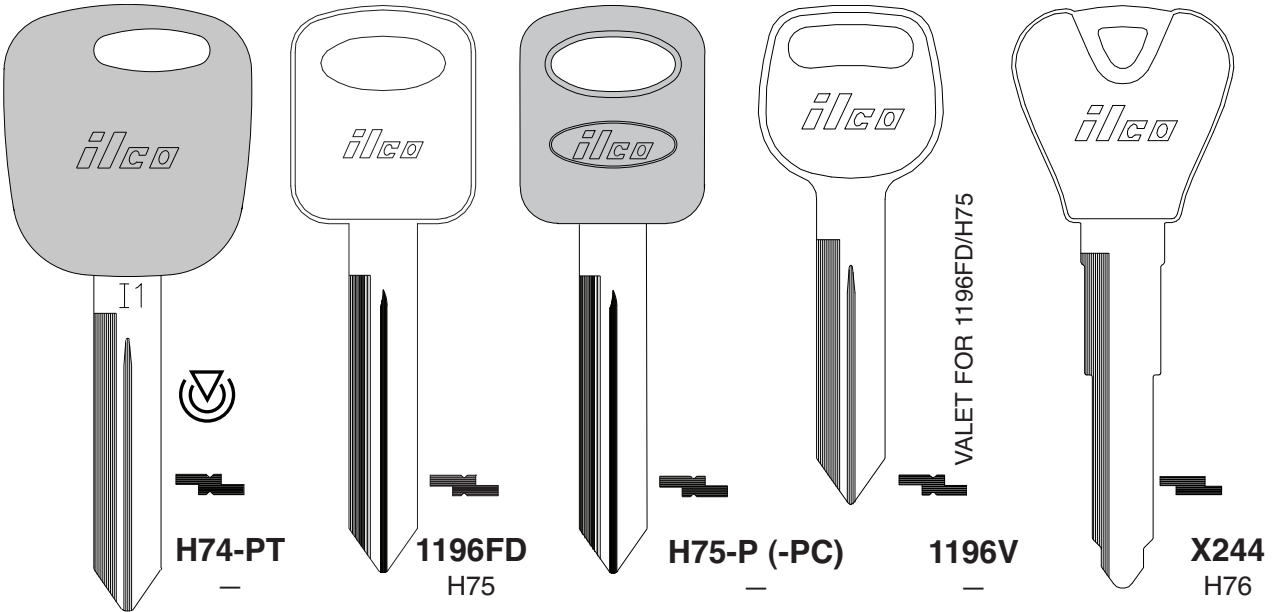

ILCO EZ

FORD

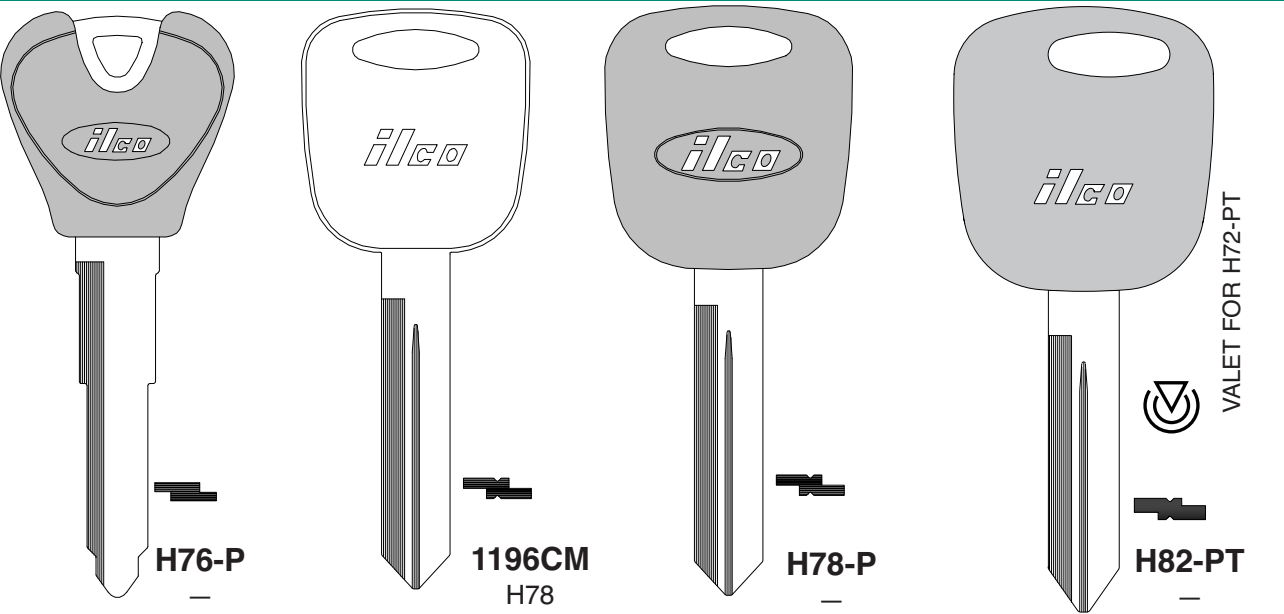

ILCO EZ

FORD

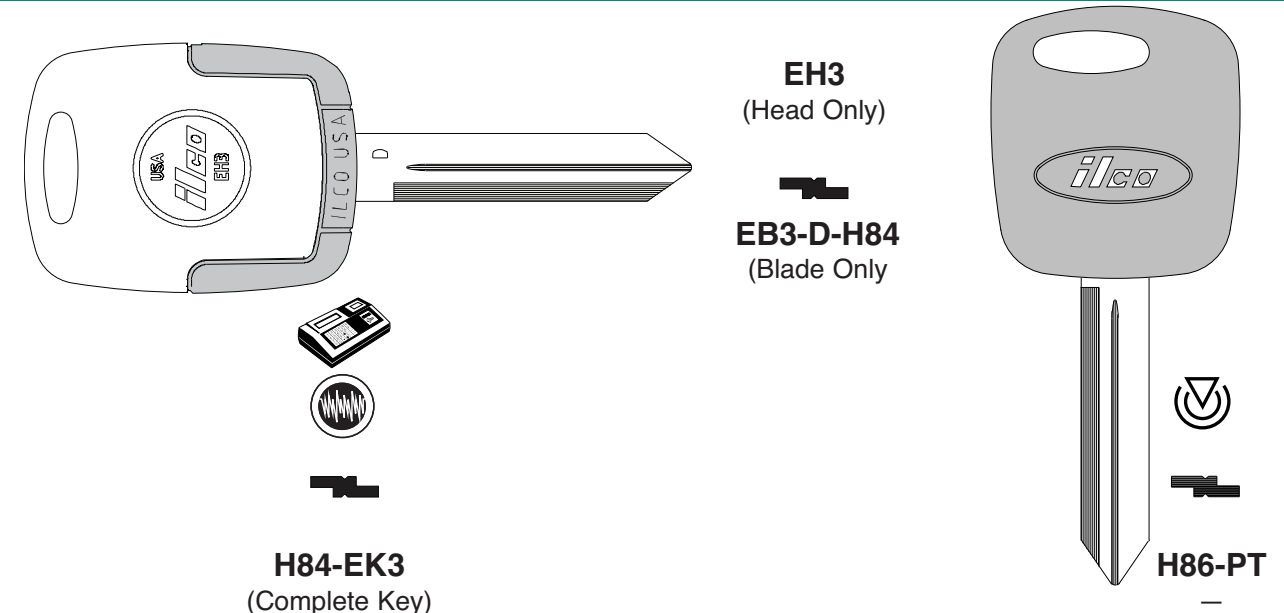

ILCO EZ

FORD

FORD INTERNATIONAL

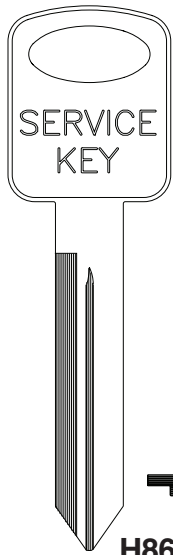

H86-SERVICE KEY

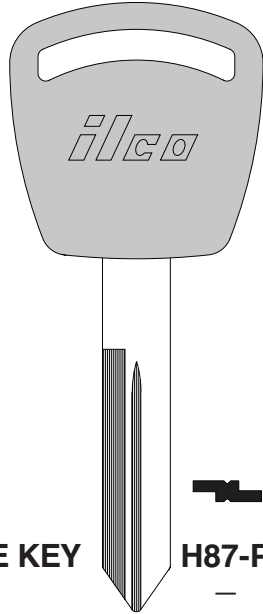

H87-P

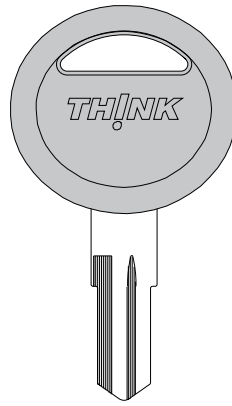

TH1-P

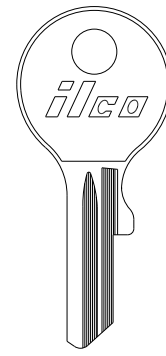

BU1

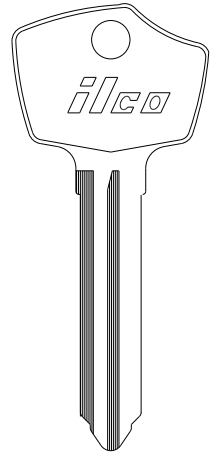

FF1



BU2

ILCO
EZ

FORD

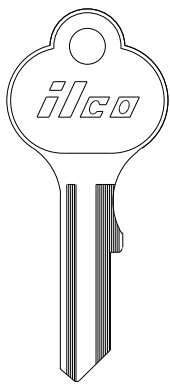

VW1

—

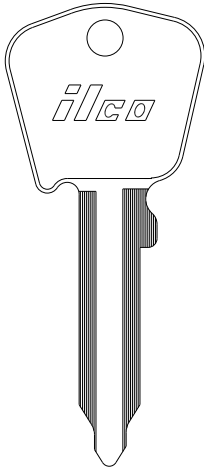

KL2

—

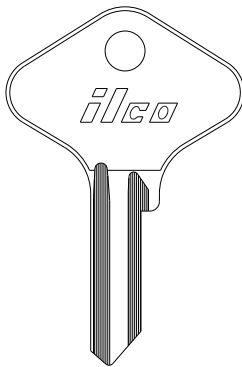

FT5R

—

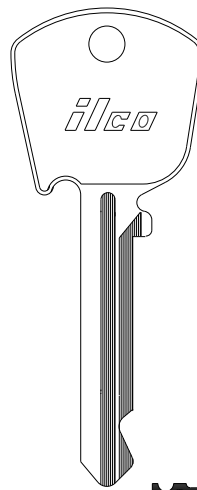

DO3L

—

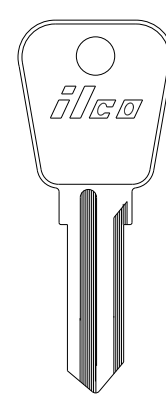

FT3

—

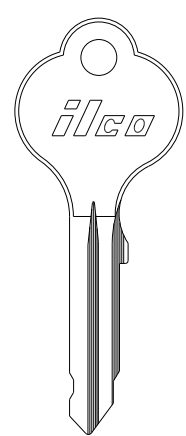

YM3

—



SR3

—

ILCO
EZ

FORD INTERNATIONAL

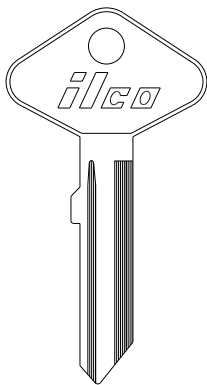

CA4

—

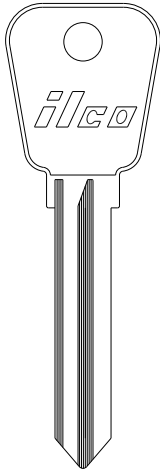

CE4

—

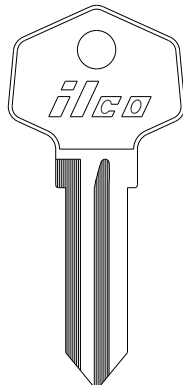

CE6

—

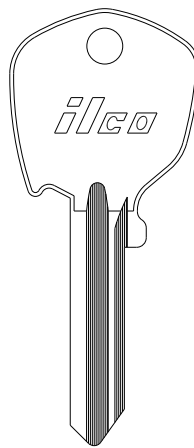

FT6

—

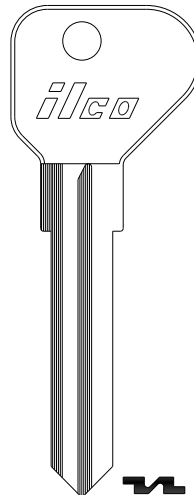

CE7

—

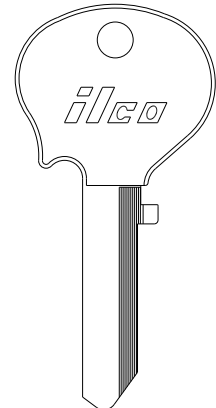

NE7

—

ILCO
EZ

FORD INTERNATIONAL

VEHICLE

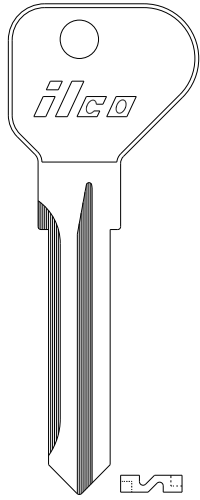

CE8

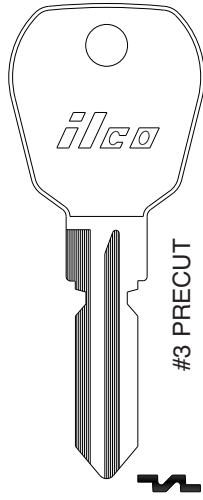

FC8

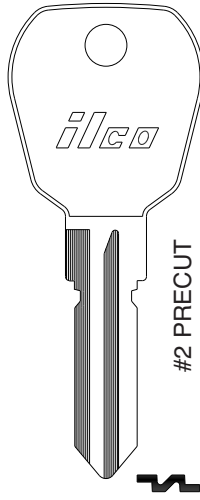

FC9

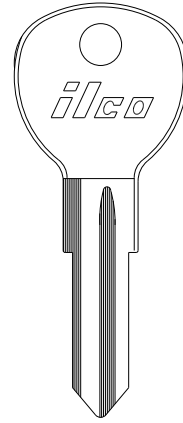

FT10 FT10R

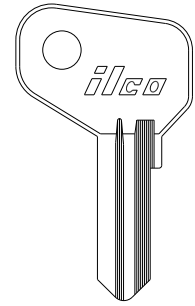

SF11

ILCO
EZ

FORD INTERNATIONAL

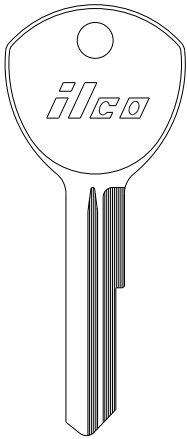

HF12 HF13

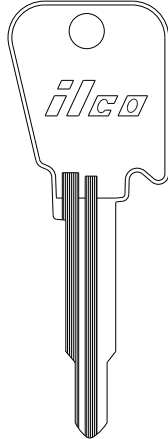

X13
LF4

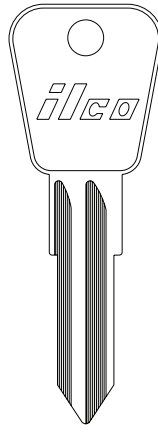

YM15

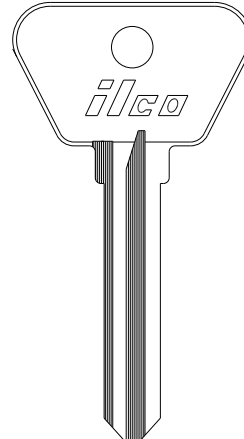

BR20

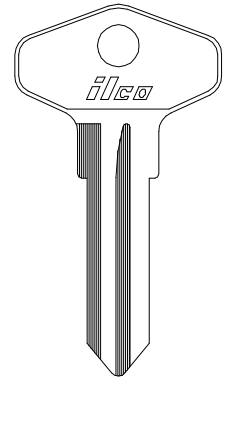

X20
FC2

ILCO
EZ

FORD INTERNATIONAL

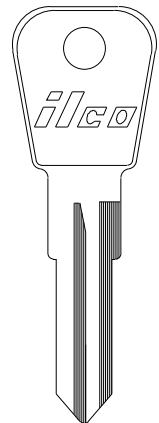

X21
YS1

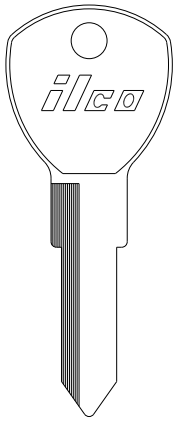

HF22 HF23

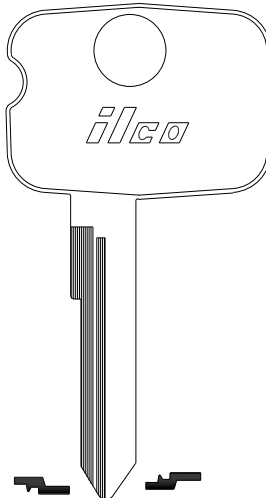

YM29 YM30

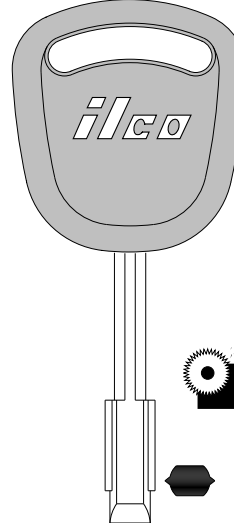

S30FD-P

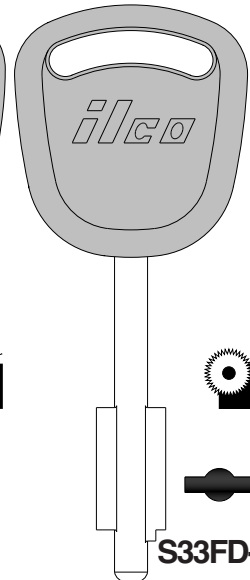

S33FD-P

ILCO
EZ

FORD INTERNATIONAL

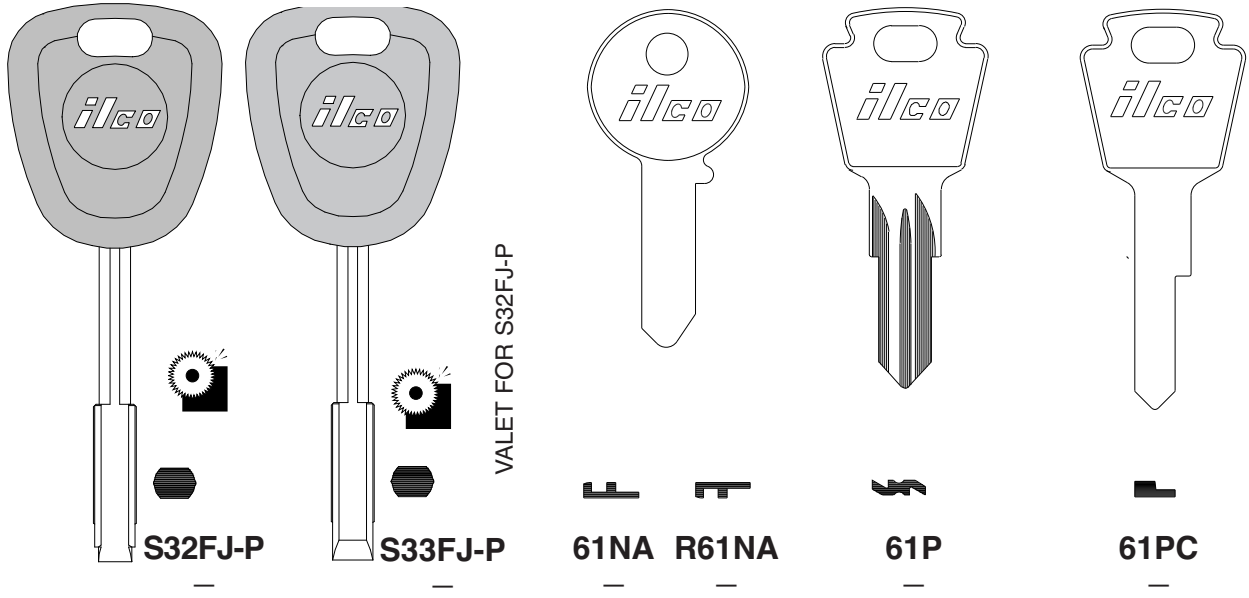

ILCO
EZ

VEHICLE

sec 1 page 47

FORD INTERNATIONAL

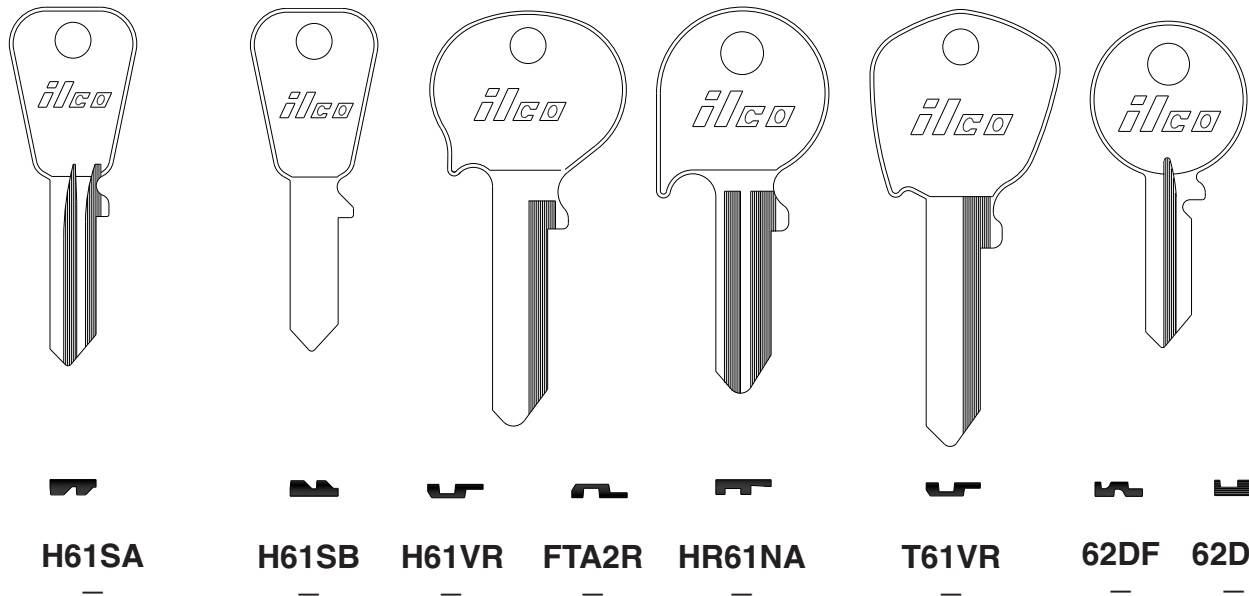

ILCO
EZ

FORD INTERNATIONAL

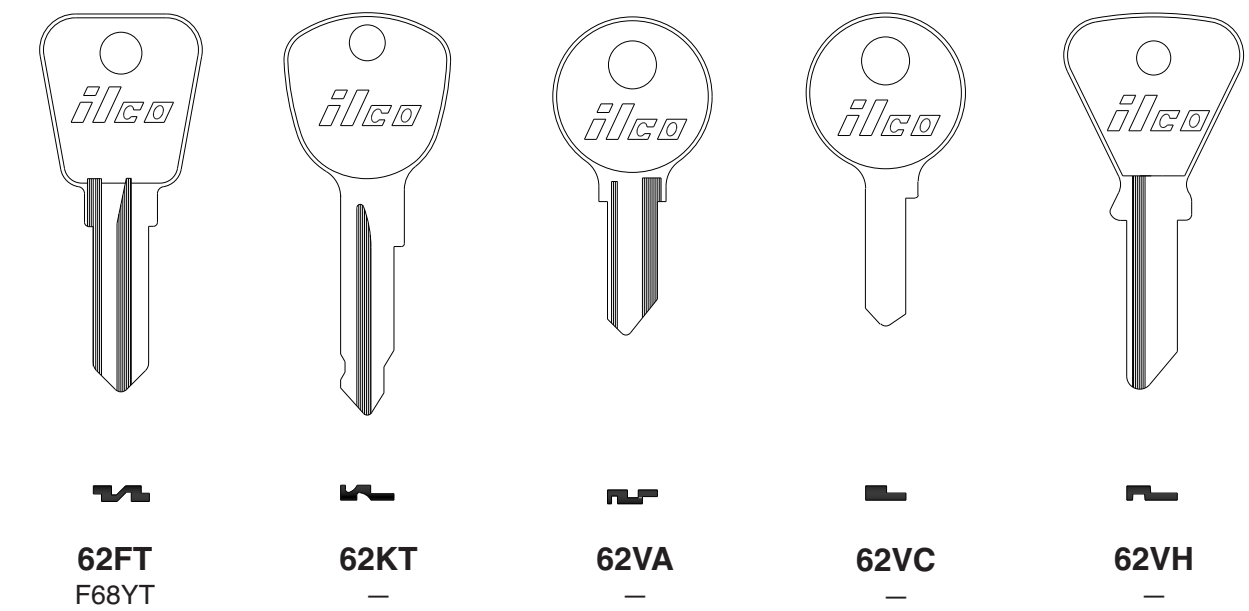

ILCO
EZ

FORD INTERNATIONAL

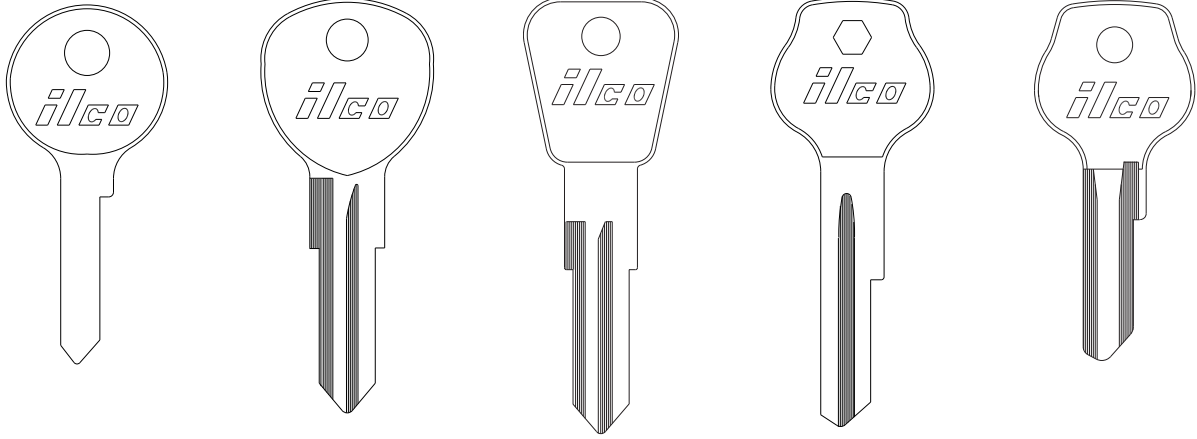

A62VC	H62FD	HR62FD	L62FD	LR62VB	R63Y	R62VB	G63Y
—	—	—	—	—	—	—	—

ILCO
EZ

FORD INTERNATIONAL

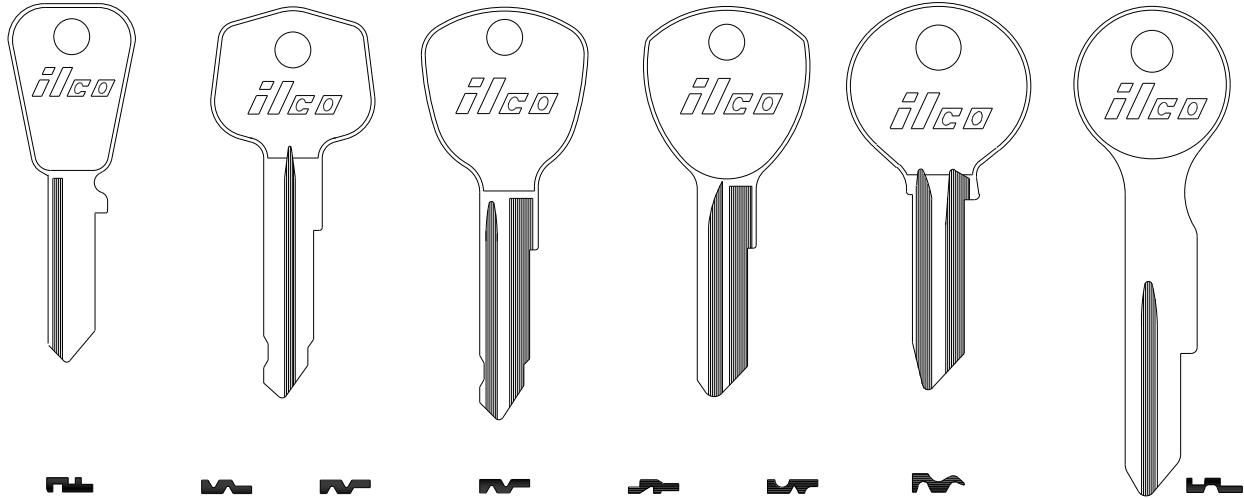

S62DP	63E	R63E	R63KE	R63TK	R63TY	H64E	65J
—	—	—	—	—	—	—	—

ILCO
EZ

FORD INTERNATIONAL

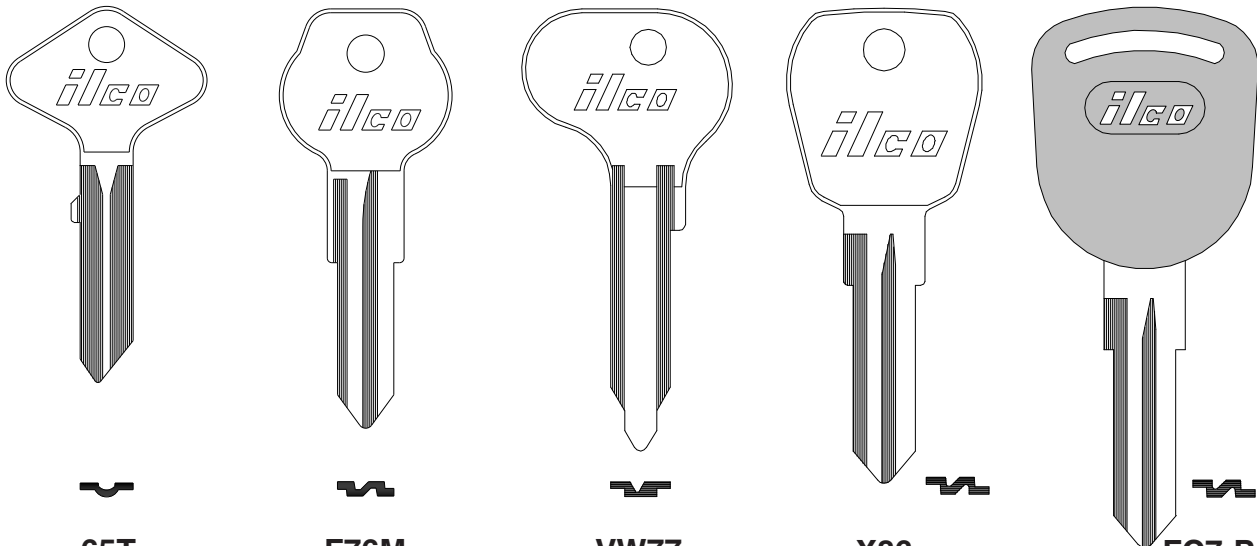

65T	F76M	VW77	X86	FC7-P
—	—	—	FC7	—

ILCO
EZ

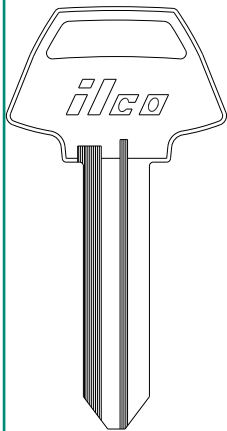
FORD INTERNATIONAL
FORD AUSTRALIA FORD TRACTOR

P1127C

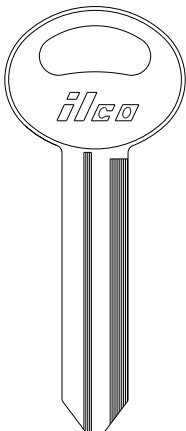
—

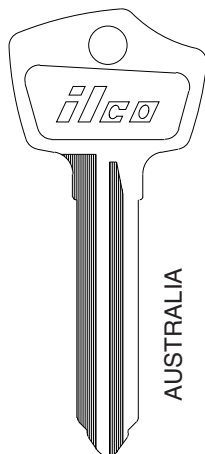

S1167C

—

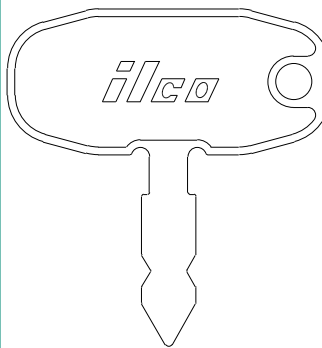

FF2

—

AUSTRALIA

1569

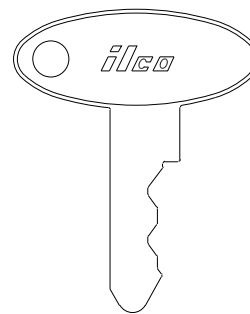
—

1570

—

 ILCO
EZ

VEHICLE

 sec
1

 page
49

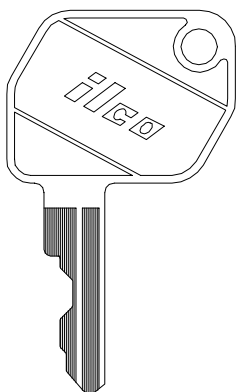
FORD TRACTOR
FORD TRUCK COVER FREIGHTLINER

1592

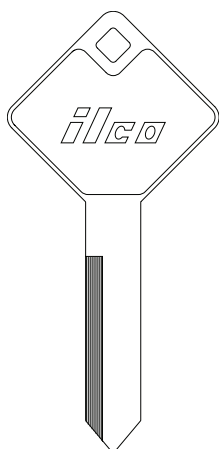
—

1660

—

1041T

CG16

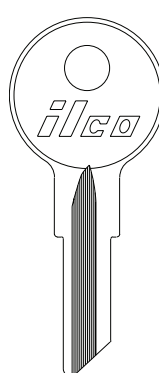
1098M

B1

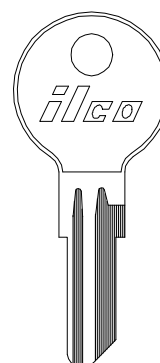

O1122A

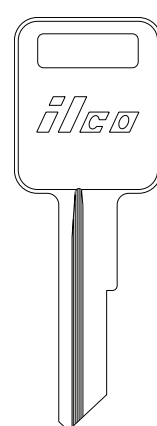
Y12

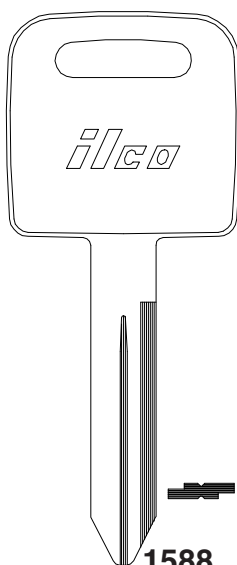

1584

—

 ILCO
EZ

FREIGHTLINER
GAS CAP LOCK

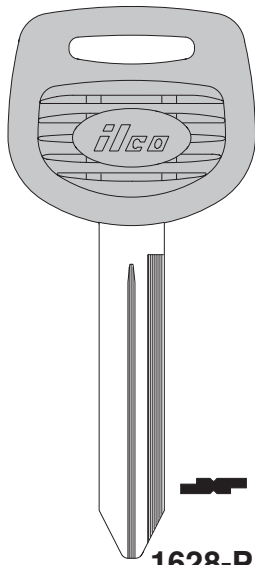
1588

—

1628-P

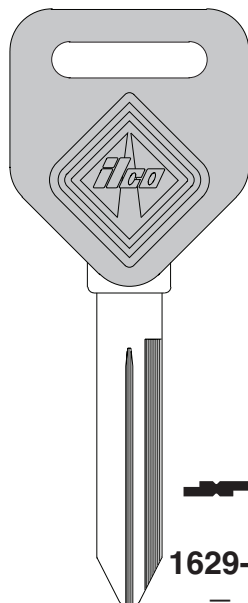
—

1629-P

—

GC1

—

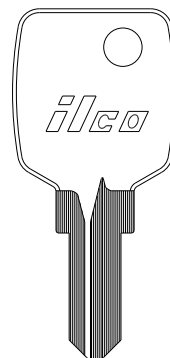
PN1

—

 ILCO
EZ

GAS CAP LOCK

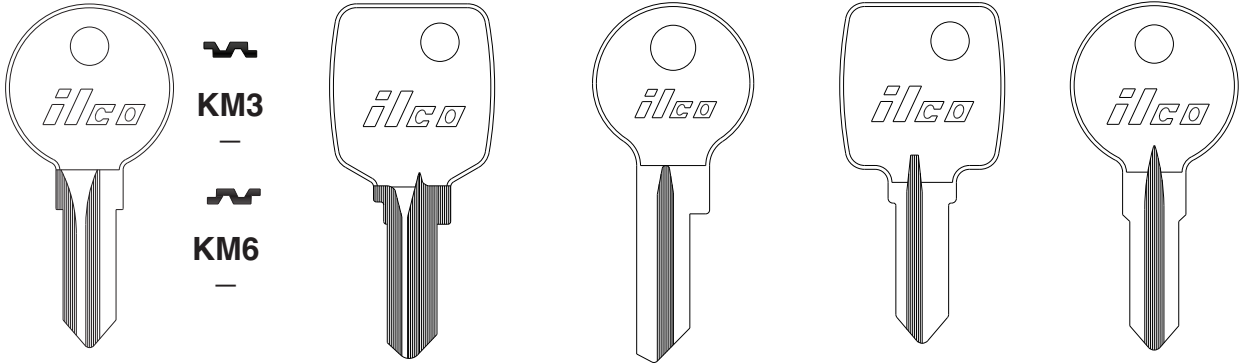

KM3 —
 KM6 —
 KM2 —
 PN2 —
 BU3 —
 PN3 —
 KM4 —

ILCO
EZ

GAS CAP LOCK

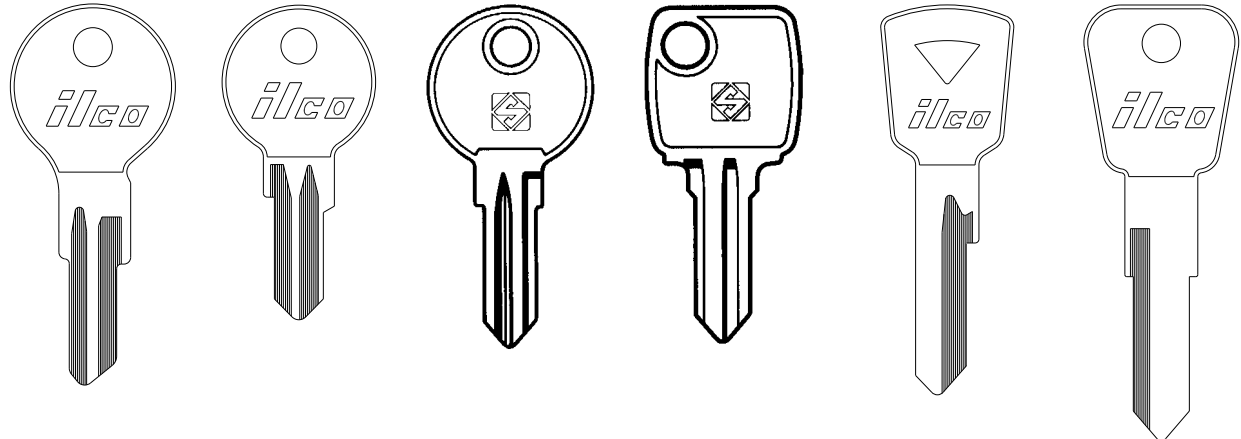

Z4 —
 KM5 —
 KM7 —
 KI10R —
 KI17 —
 WS10 —
 WS11 —

ILCO
EZ

GAS CAP LOCK

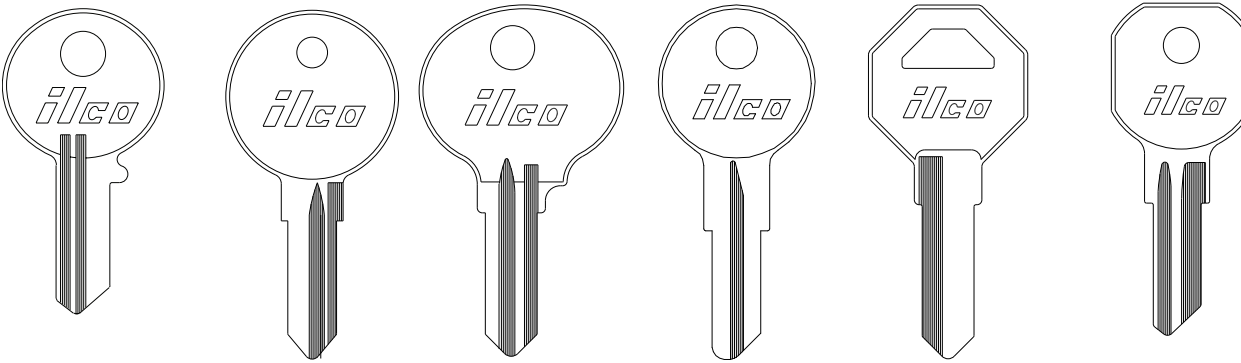

V61S —
 63H —
 R63H —
 H63G —
 1098GX
B52
 1546 —
 1574 —

ILCO
EZ

GAS CAP LOCK

GEO

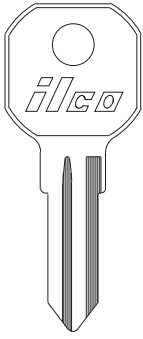

1611
—

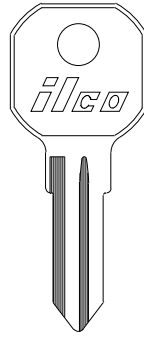

1611R
—

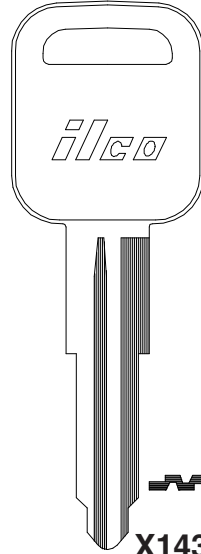

X143
B53

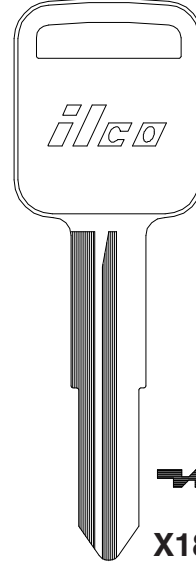

X180
B69

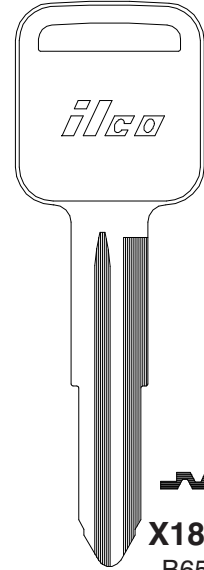

X184
B65

ILCO
EZ

GEO

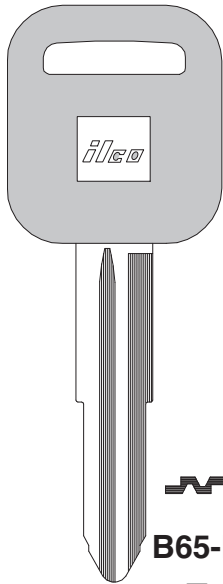

B65-P
—

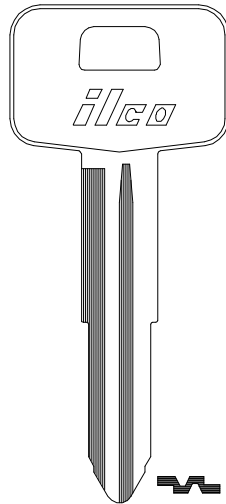

X192
B72

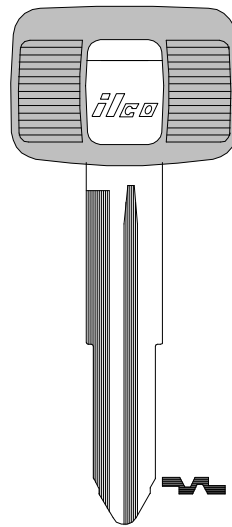

B72-P
—

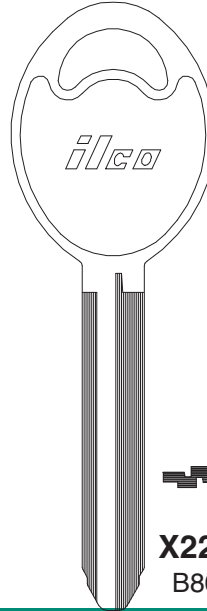

X225
B80

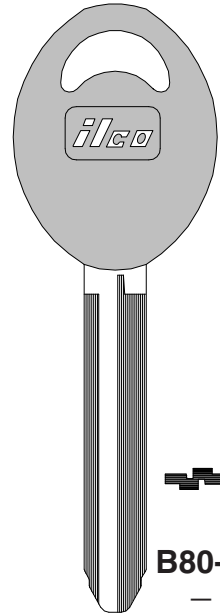

B80-P
—

ILCO
EZ

GENERAL MOTORS

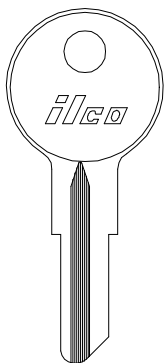

1098L
B3

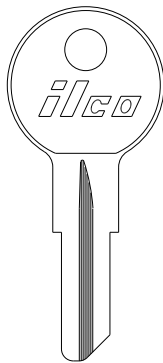

1098X
—

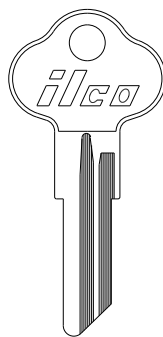

C1098A
—

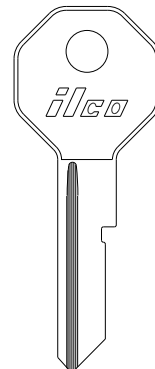

H1098A
—

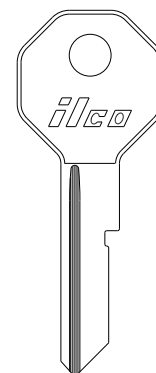

H1098C
—

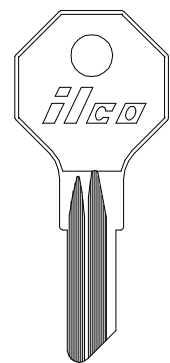

H1098DB
B16

ILCO
EZ

GENERAL MOTORS

VEHICLE

sec 1 page 52

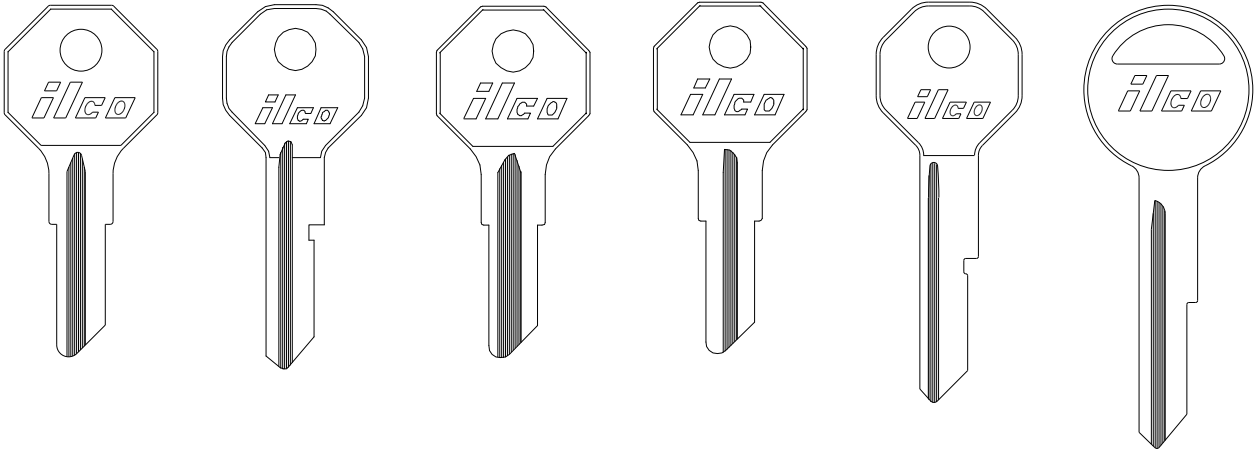

H1098L —	H1098LA B10	H1098M B2	H1098X B24	L1098C —	L1098LA —

ILCO
EZ

GENERAL MOTORS

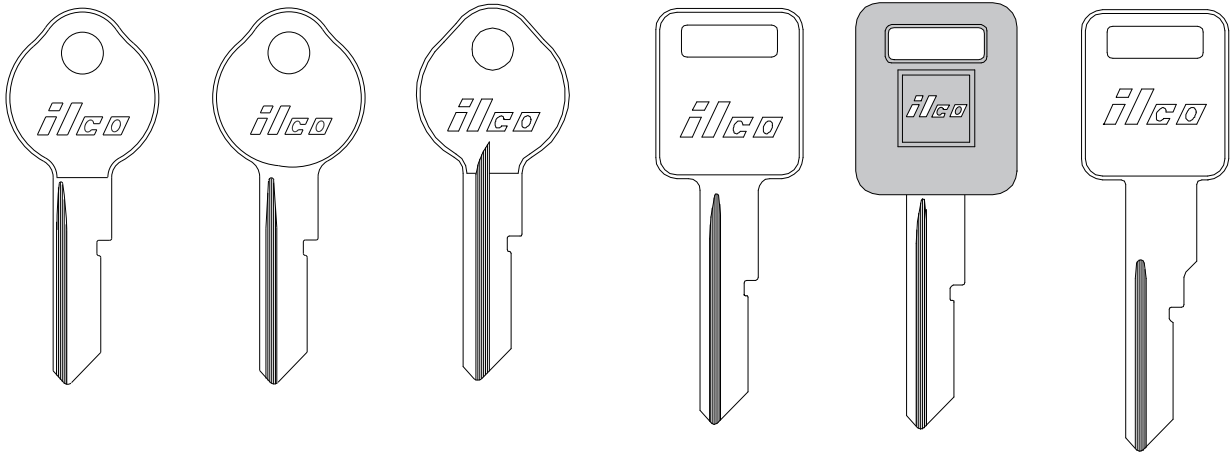

O1098B —	O1098D B43	O1098LA B11	P1098A B48	B48-P (-PC) —	P1098AV B62

ILCO
EZ

GENERAL MOTORS

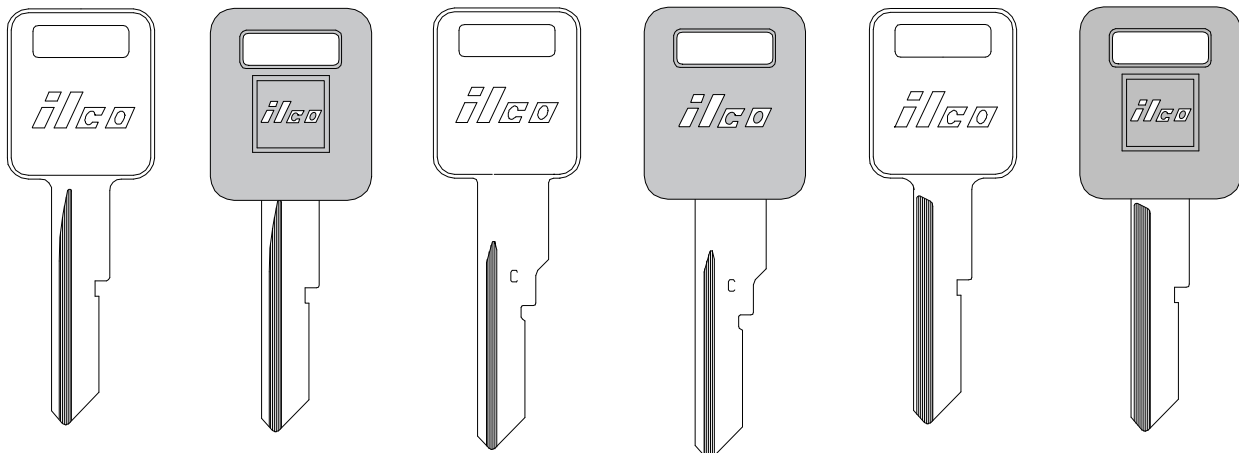

P1098C B50	B50-P (-PC) —	P1098CV B63	B63-P (-PC) —	P1098E B44	B44-P (-PC) —

ILCO
EZ

GENERAL MOTORS

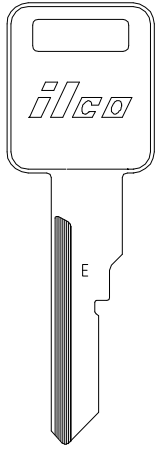

P1098EV
B77

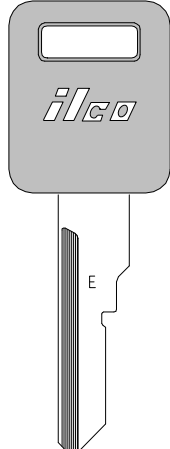

B77-P (-PC)
—

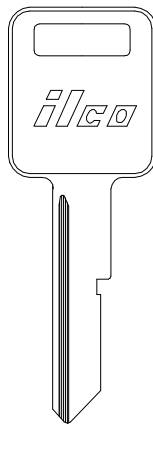

P1098J
B46

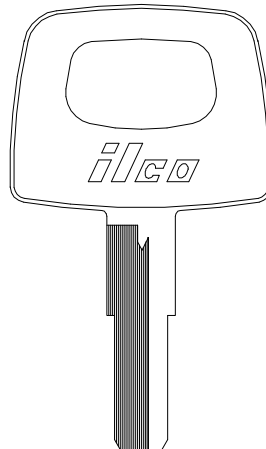

P1098V
LUV1

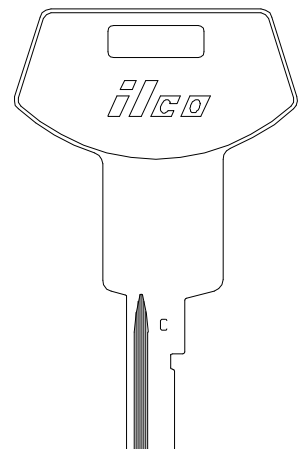

P1098WC
B64

ILCO
EZ

GENERAL MOTORS

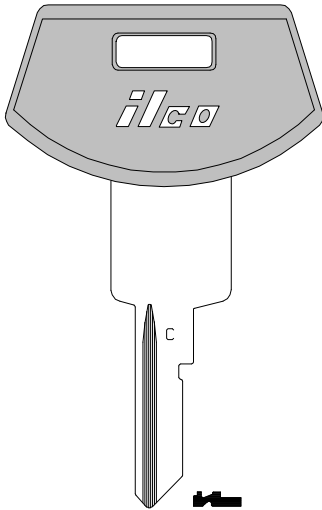

B64-P (-PC)
—

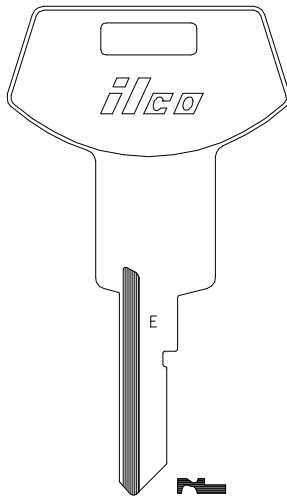

P1098WE
B78

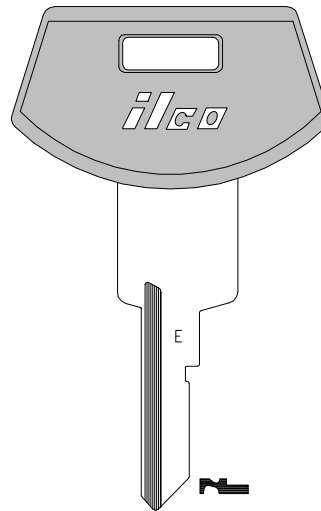

B78-P (-PC)
—

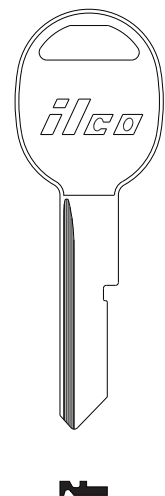

S1098B
B49

ILCO
EZ

GENERAL MOTORS

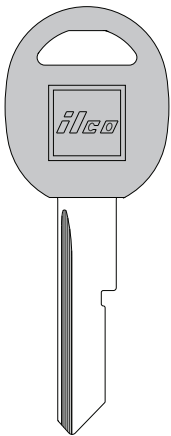

B49-P (-PC)
—

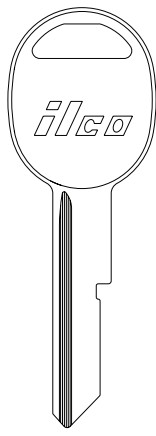

S1098D
B51

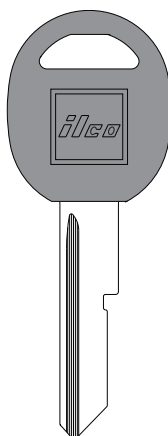

B51-P (-PC)
—

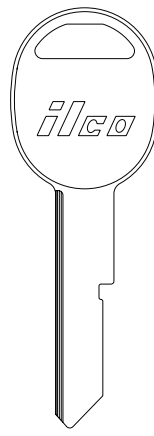

S1098H
B45

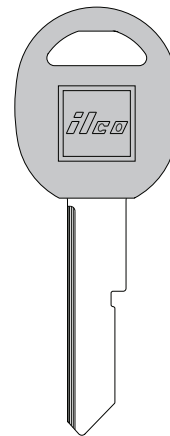

B45-P (-PC)
—

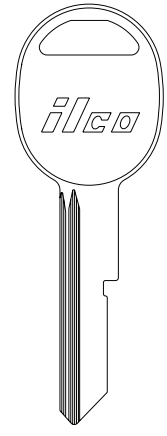

S1098K
B47

ILCO
EZ

GENERAL MOTORS

VEHICLE

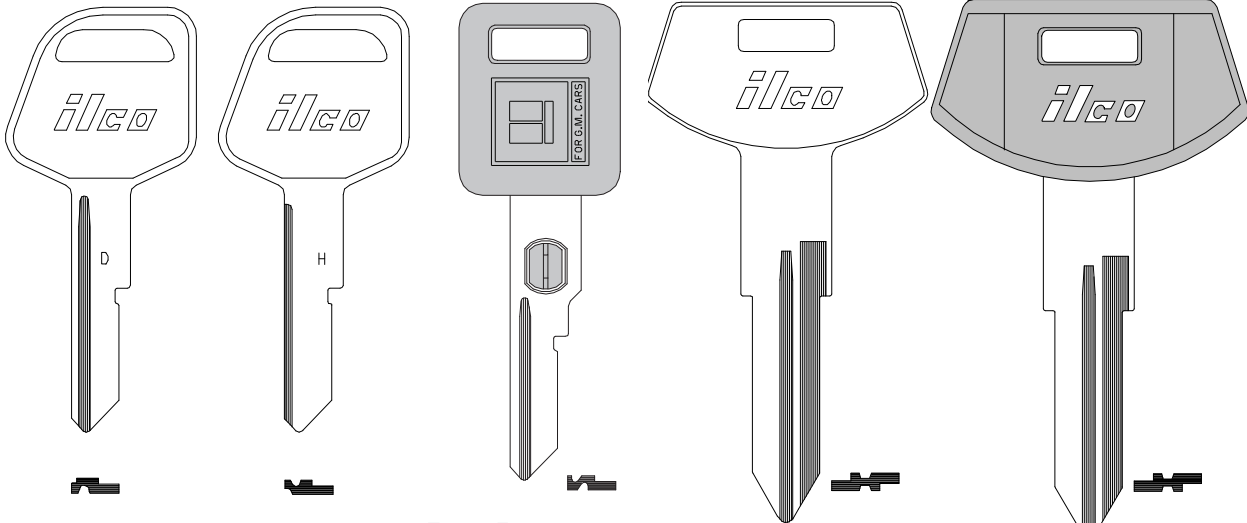

S1098WD
B67

S1098WH
B79

B62-P-1 thru 15
VATS

P1099
B68

B68-P (-PC)
—

ILCO
EZ

sec 1 page 54

GENERAL MOTORS

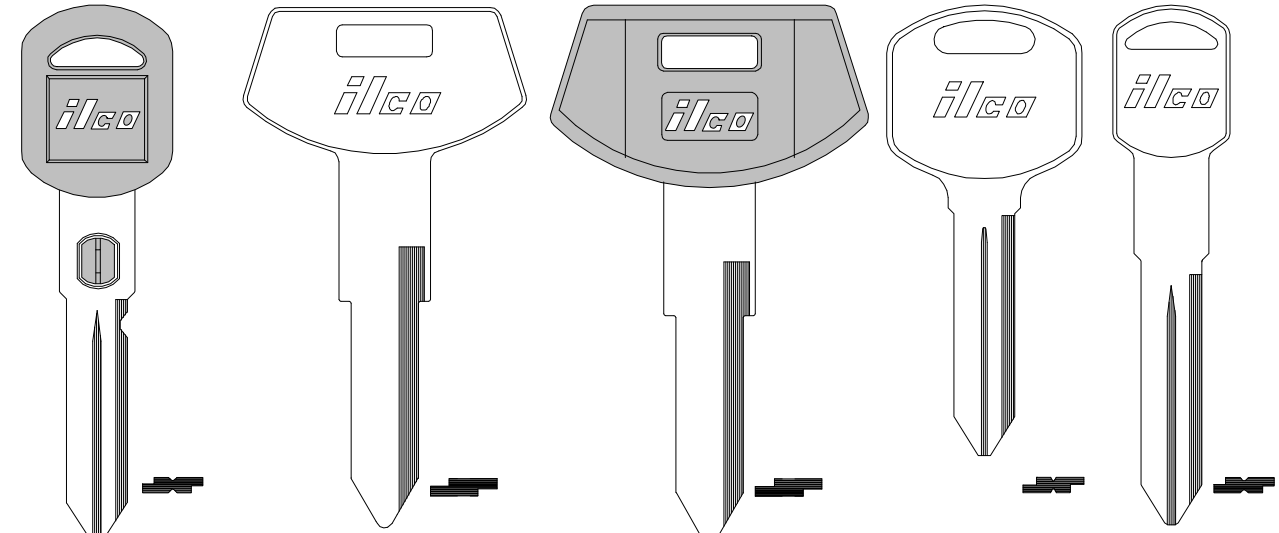

B82-P-2 thru 15
VATS

P1101
B84

B84-P
—

S1105
B85

P1106
B86

ILCO
EZ

GENERAL MOTORS

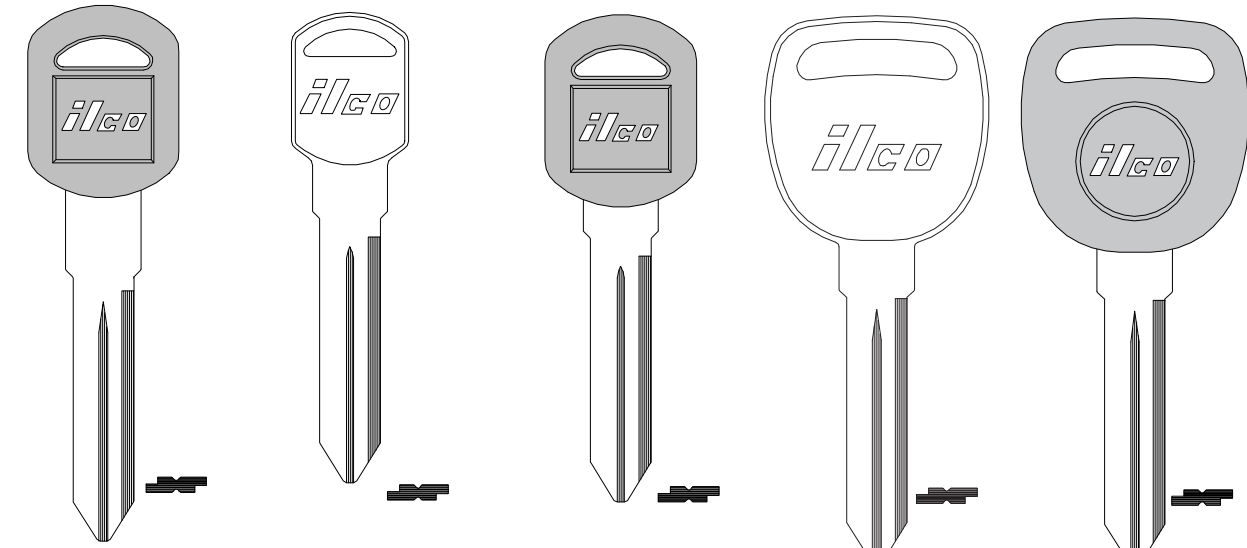

B86-P (-PC)
—

P1107
B89

B89-P
—

P1111
B91

B91-P
—

ILCO
EZ

GENERAL MOTORS

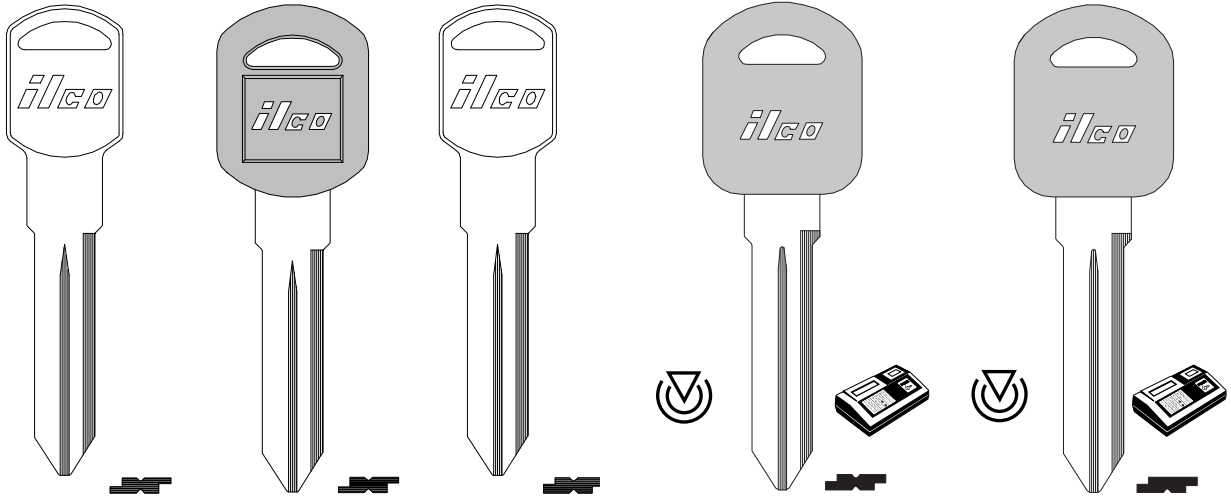

ILCO
EZ

P1109
B92

B92-P
—

1109V
—

B97-PT
—

B97-PT5
—

B98-PT
—

B98-PT5
—

GENERAL MOTORS

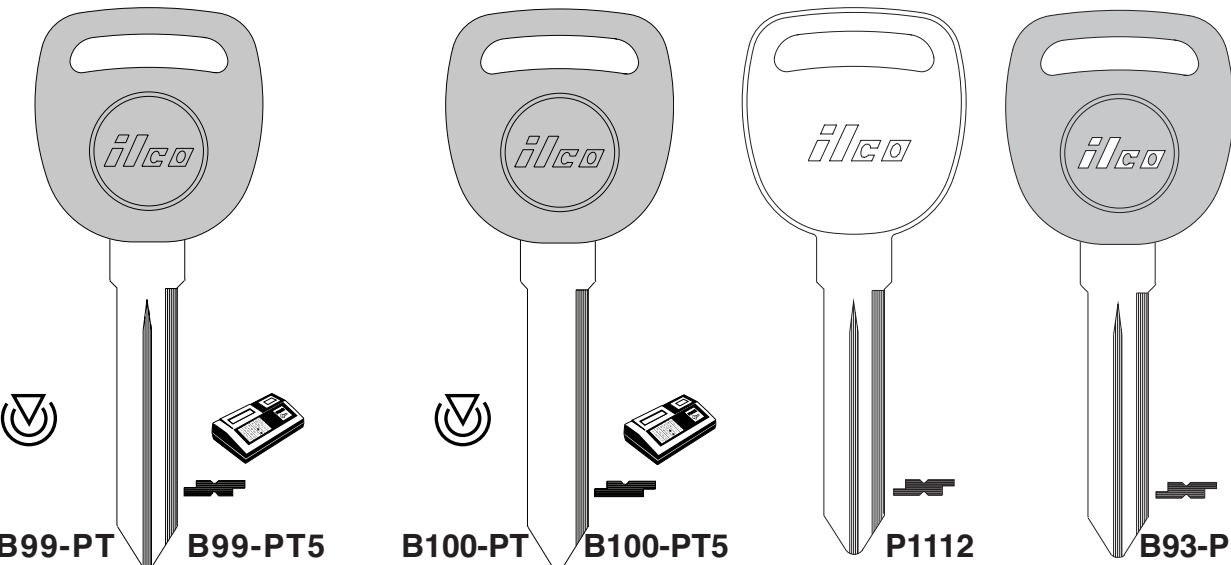

ILCO
EZ

B99-PT
—

B99-PT5
—

B100-PT
—

B100-PT5
—

P1112
B93

B93-P
—

GENERAL MOTORS

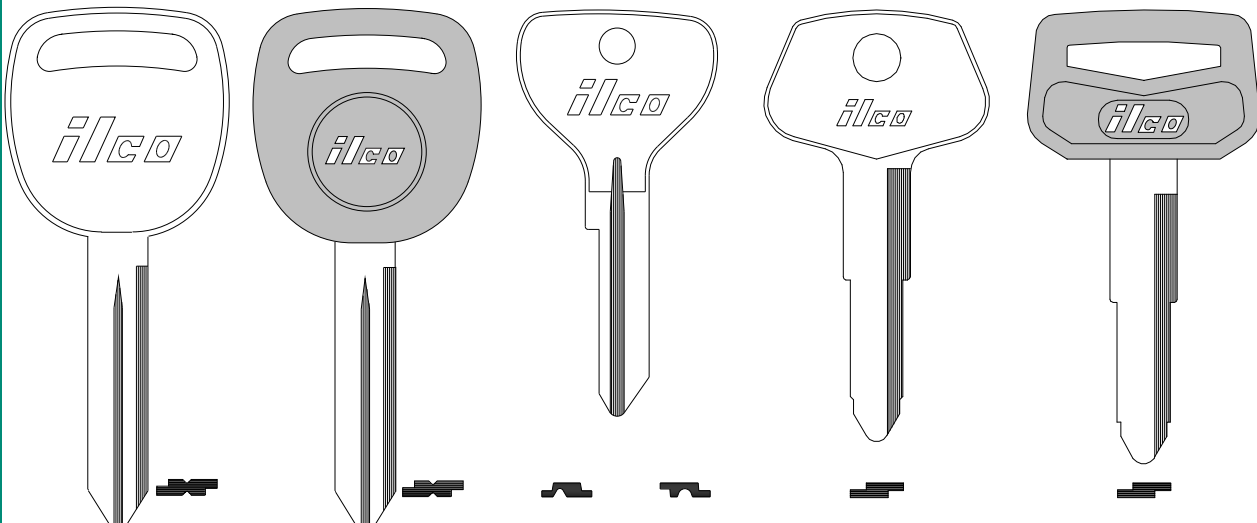

ILCO
EZ

P1113
B102

B102-P
—

OP11 **U62VP**
— —

X54
DC1

DC1-P
—

GENERAL MOTORS

VEHICLE

sec 1 page 56

X121
DC3

DC3-P (-PC)
—

X143
B53

X145
B55

X146
B56

ILCO
EZ

GENERAL MOTORS

X154
B54

X162
B59

X168
B61

X180
B69

HU46T2
—

ILCO
EZ

GENERAL MOTORS

B103-PT
—

B103-PT5
—

B104-PT
—

B104-PT5
—

B104-P-2 thru 15
VATS

P1114
B110

ILCO
EZ

GENERAL MOTORS

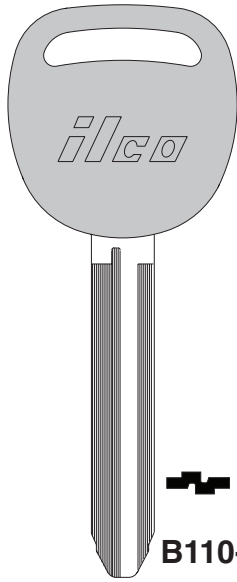

B110-P

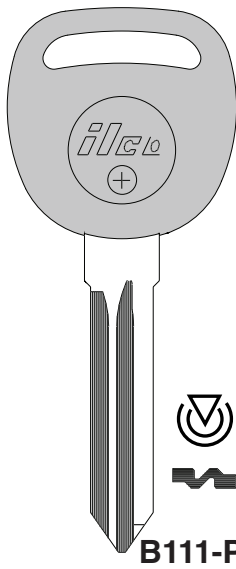

B111-PT

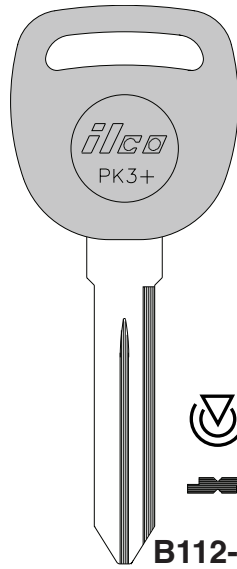

B112-PT

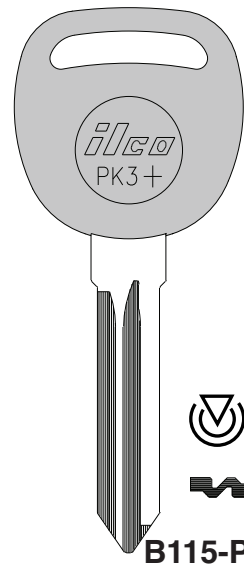

B115-PT

ILCO
EZ

VEHICLE

sec 1 page 57

GENERAL MOTORS

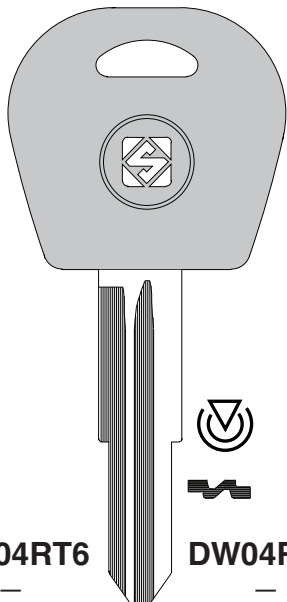

DW04RT6



HU100-P

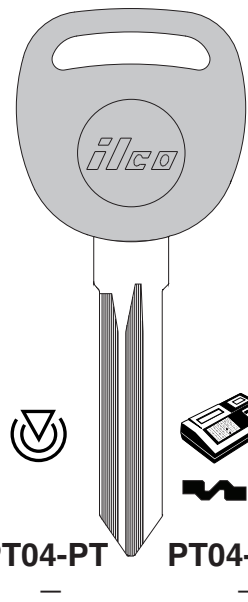

PT04-PT



PT04-PT5

ILCO
EZ

GENERAL MOTORS

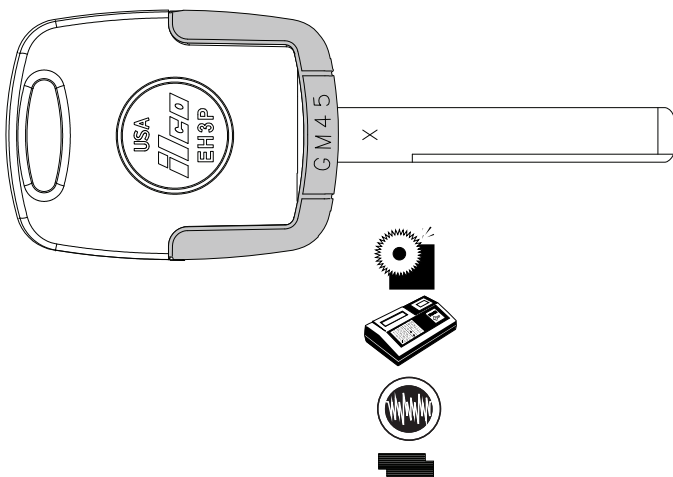

EK3P-GM45
(Complete Key)

EH3P
(Head Only)

EB3-X-GM45
(Blade Only)

ILCO
EZ

GENERAL MOTORS

VEHICLE

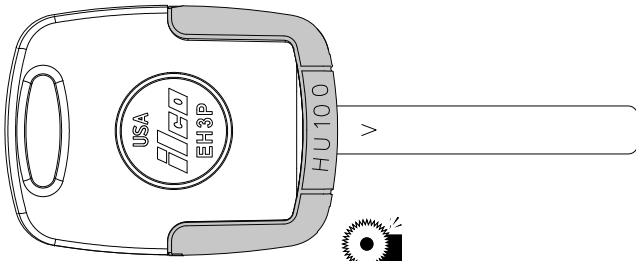

EH3P
(Head Only)

EB3-V-HU100
(Blade Only)



EK3P-HU100
(Complete Key)

ILCO
EZ

sec 1 page 58

GENERAL MOTORS

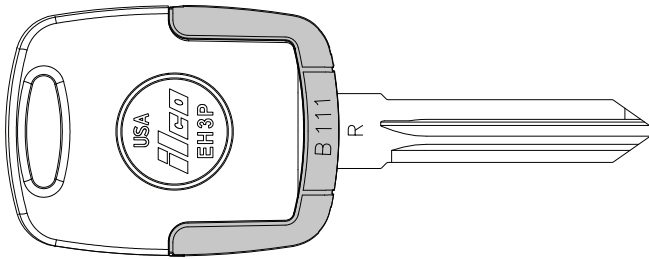

EH3P
(Head Only)

EB3-R-B111
(Blade Only)



EK3P-B111
(Complete Key)

ILCO
EZ

GENERAL MOTORS INTERNATIONAL

GILERA

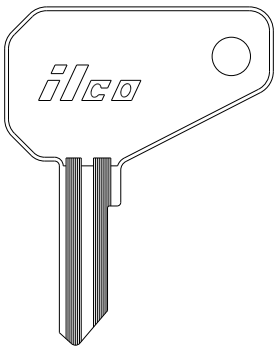

SZ4
—

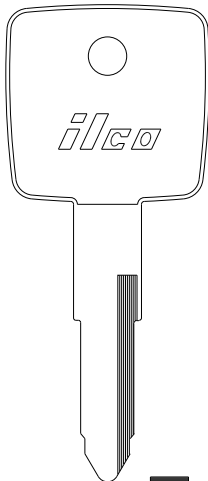

SZ5
—



HT98
—

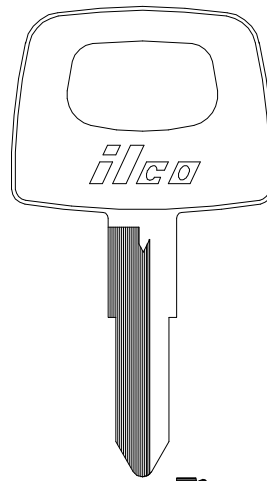

P1098V
LUV1



ZD17RAP-SI
LUV1

ILCO
EZ

GILERA

GOGOMOBILE

GOLF CART



ZD24RDP-SI

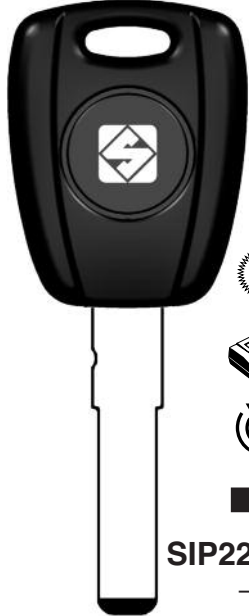

SIP22T5-SI

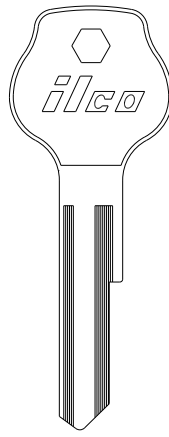

L62VA

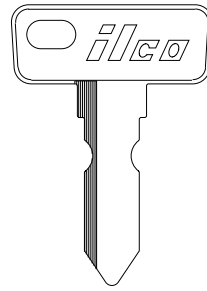

CC1

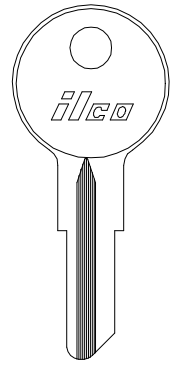

1098L
B3

ILCO
EZ

GOLF CART

GRUMMAN LONG LIFE
VEHICLE (POST OFFICE)

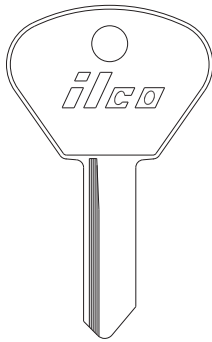

F91G

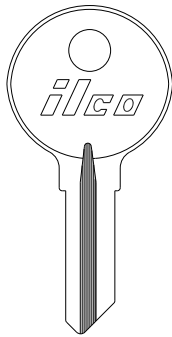

1069B

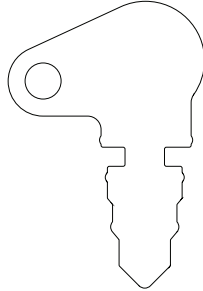

1147

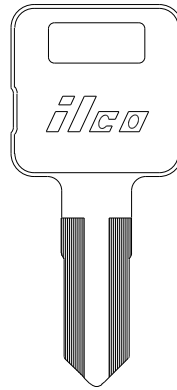

1524

ILCO
EZ

HARLEY DAVIDSON

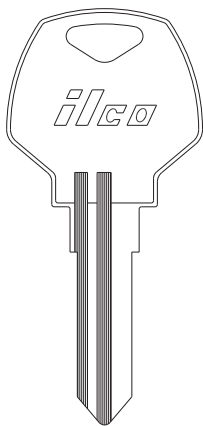

HYD1



HYD5

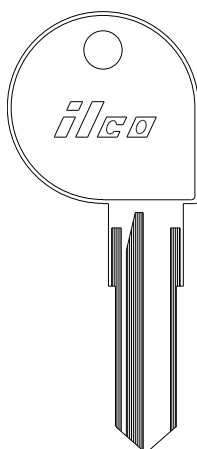

HYD6



HYD10

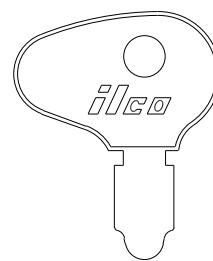

X70

ILCO
EZ

HARLEY DAVIDSON

X94	X98	X125						
-	-	-						
X95	X100	X126						
-	-	-						
X96	X101	X127						
-	-	-						
X93	X97	X102	H72G	H72H	H78KR	X234		
-	-	-	-	-	-	-		

ILCO
EZ

HARLEY DAVIDSON

				X134	X142
				-	-
				X135	
				-	
				X136	
				-	
HY6R	HY9	ISP2	X133	X141	
-	-	-	-	-	

ILCO
EZ

HARLEY DAVIDSON HEINKEL HINO

	 OD .377" - 9.6mm ID .312" - 7.9mm (BRASS)			
X226	1137B	NE5	X274	TR37
HYD12	-	-	HN3	TR33

ILCO
EZ

HINO HODAKA HONDA (AUTOMOBILES)

ILCO EZ							
	TR33-P (-PC)	HOD1	HD23	HD29	HD33	X38	X44
	—	—	—	—	—	HO41	HO44
	—	—	—	—	—	—	—
	—	—	—	—	—	—	—

HONDA (AUTOMOBILES)

ILCO EZ					
	X51 AA2	HD70	HON32P	HD71	HON33P
	—	—	—	—	—
	—	—	—	—	—

HONDA (AUTOMOBILES)

ILCO EZ					
	X71 HD70U	HD70U-P	X129 HD82	HD82-P	X130
	—	—	—	—	—
	—	—	—	—	—

HONDA (AUTOMOBILES)

HON38RP —	X181 HD90	HD90-P (-PC) —	X190 HD94	X182 HD91
			VALET FOR X181 & HD90-P (-PC)	

ILCO
EZ

HONDA (AUTOMOBILES)

HD91-P —	X195 HD98	HD98-P (-PC) —	X191 HD95	X198 B74
			VALET FOR X182, HD90-P, X195 & HD98-P (-PC)	

ILCO
EZ

HONDA (AUTOMOBILES)

B74-P —	X214 HD103	HD103-P (-PC) —	X215 HD104	X184 B65
			VALET FOR X214, HD103-P (-PC)	

ILCO
EZ

HONDA (AUTOMOBILES)

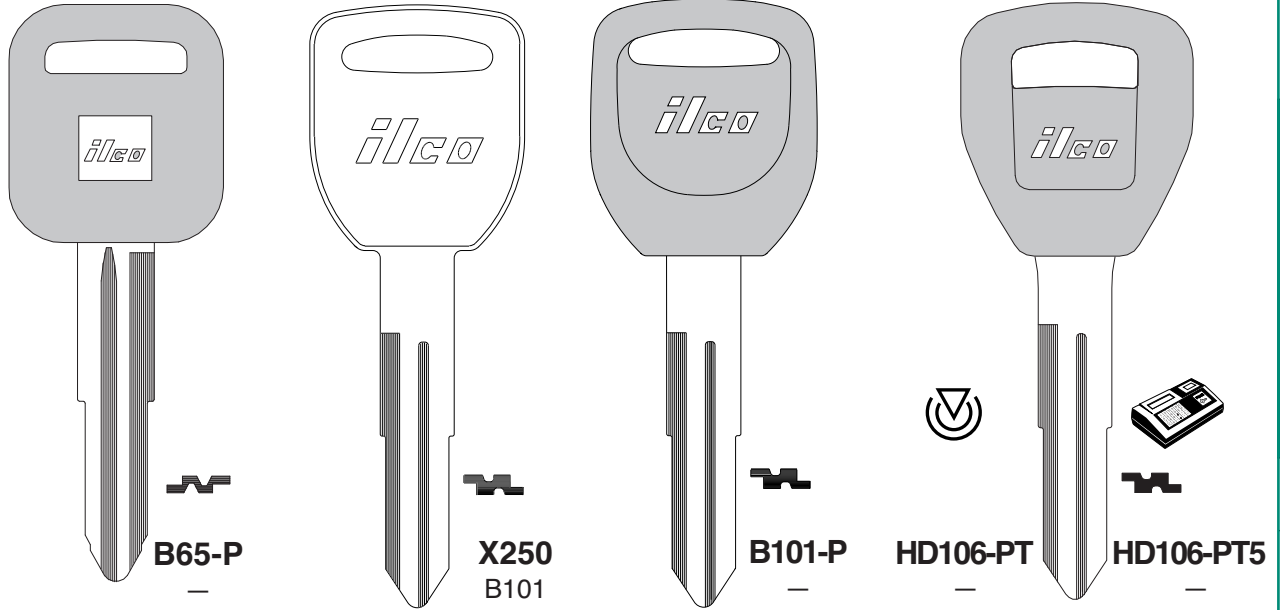
 ILCO
EZ

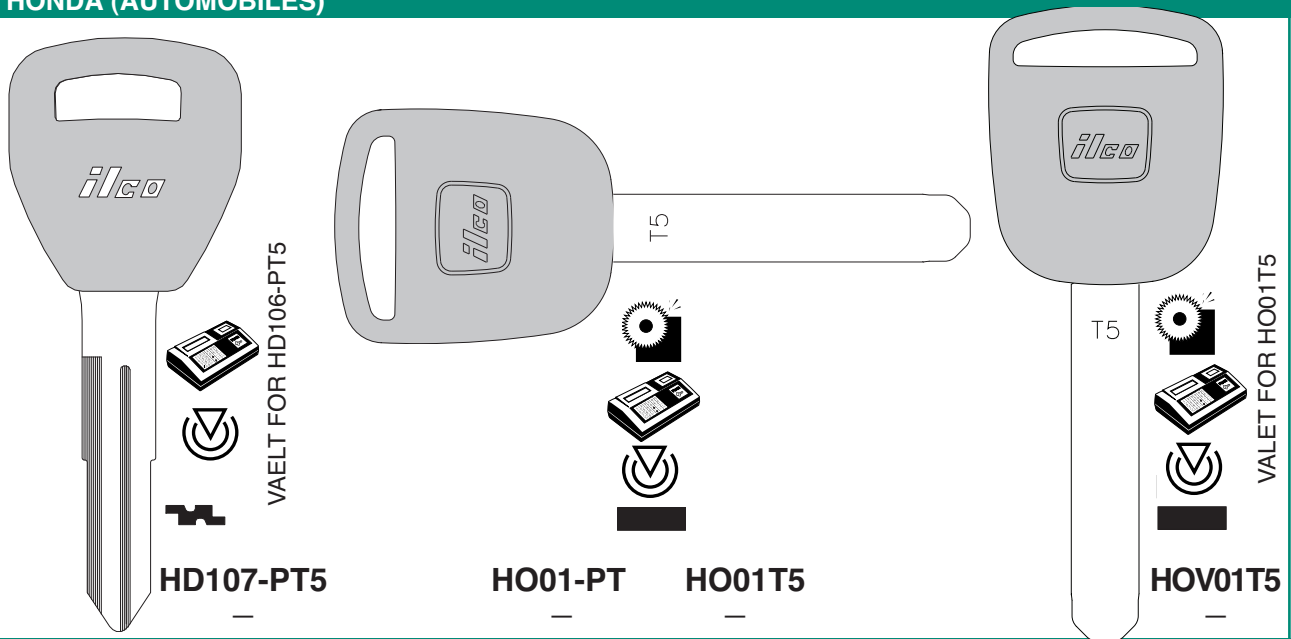
HONDA (AUTOMOBILES)

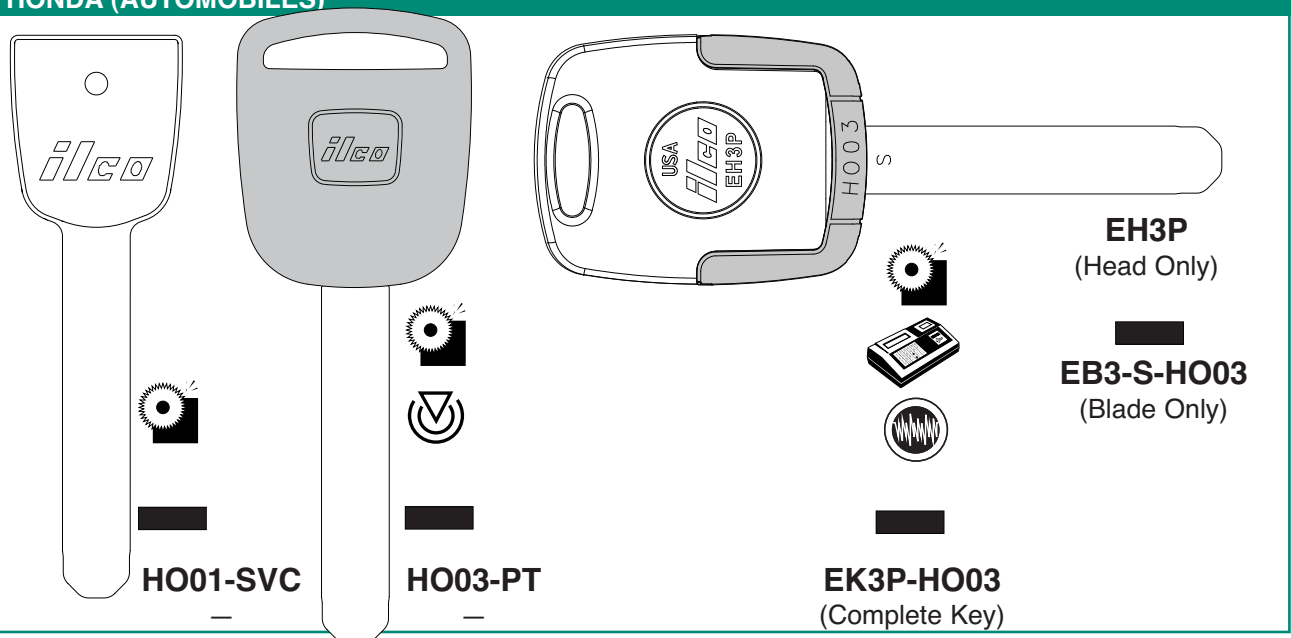
 ILCO
EZ

HONDA (AUTOMOBILES)

 ILCO
EZ

HONDA (AUTO) HONDA (MOTORCYCLES)

ILCO EZ

HONDA (MOTORCYCLES)

ILCO EZ

HONDA (MOTORCYCLES)

ILCO EZ

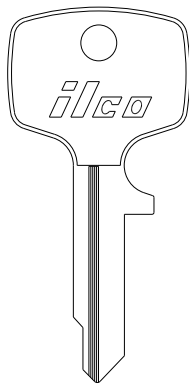
HONDA (MOTORCYCLES)

HO61Q
—

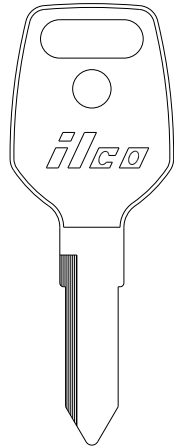
67J
—

R67K
—

X19
HD40

X38
HO41

HD25
—

H67K
—

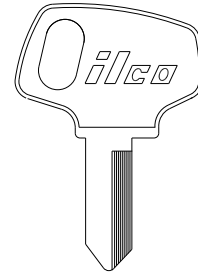
S67K
—

SR67K
—

HD37
—

HD38
—

HD39
—

HD24
—

HD36
—

HD46
—

ILCO
EZ

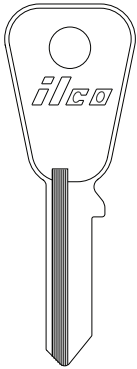
HONDA (MOTORCYCLES)

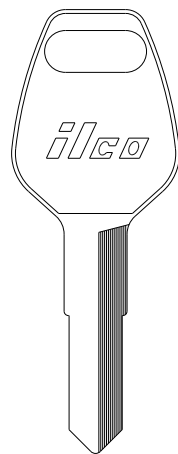
X42
HD47

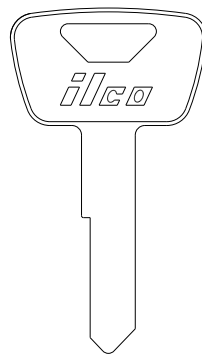
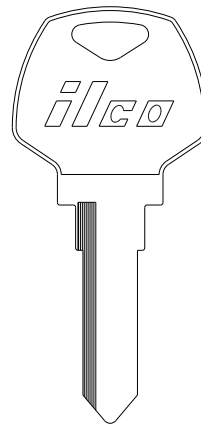
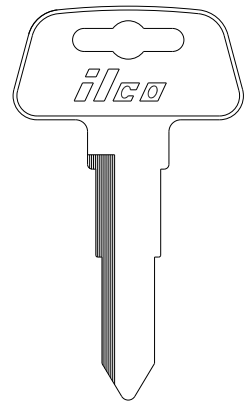
X43
HD48

X44
HO44

HD45
—

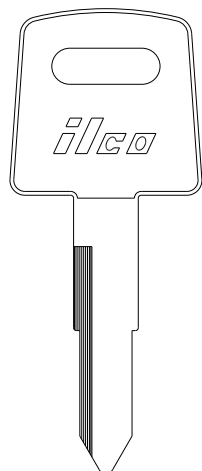
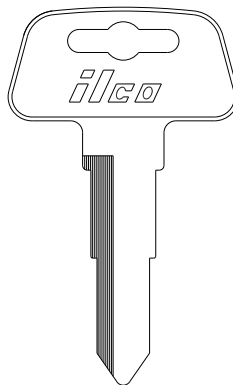
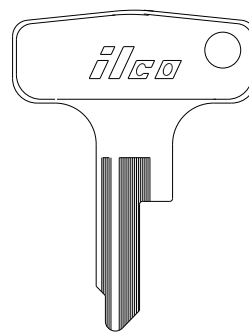
HD49
—

HD51
—

HD53
—

ILCO
EZ

HONDA (MOTORCYCLES)

HD56
—

X57
HD72

HD58
—

HD59
—

HD60
—

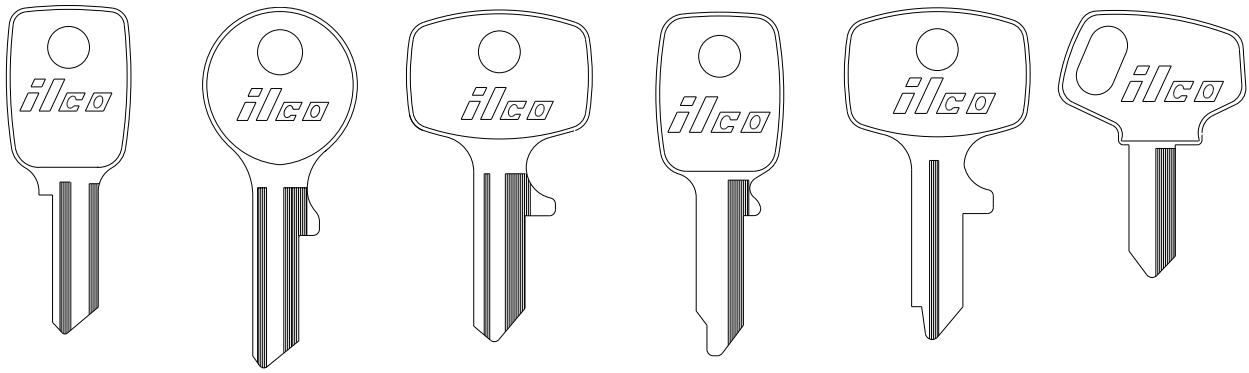
HD61
—

ILCO
EZ

HONDA (MOTORCYCLES)



HO61C	HO61D	HO61E	HO61H	HO61R	HD62
—	—	—	—	—	—

ILCO
EZ

HONDA (MOTORCYCLES)

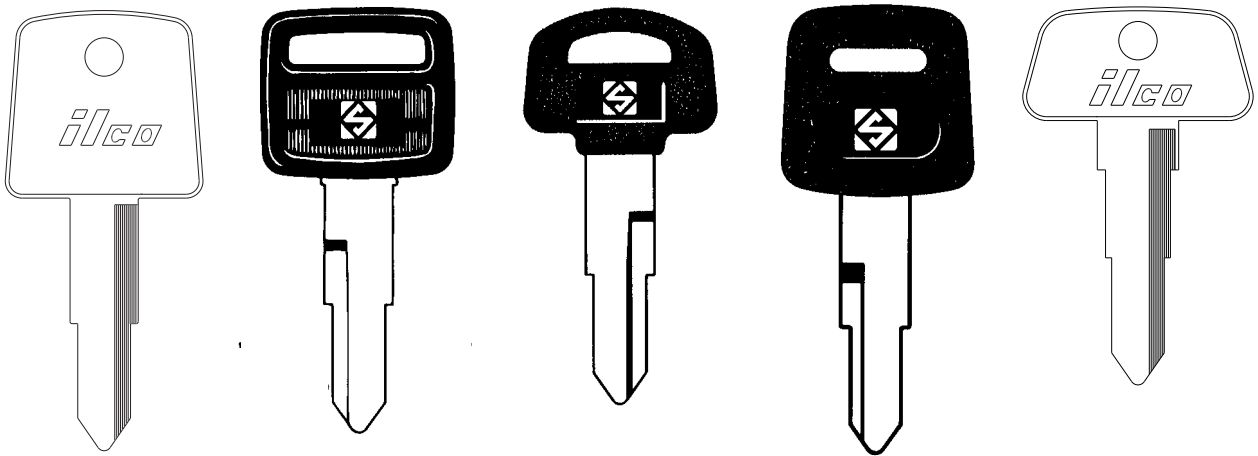

HD63	HON31RAP	HON31RBP	HON31RP	HD64
—	—	—	—	—

ILCO
EZ

HONDA (MOTORCYCLES)

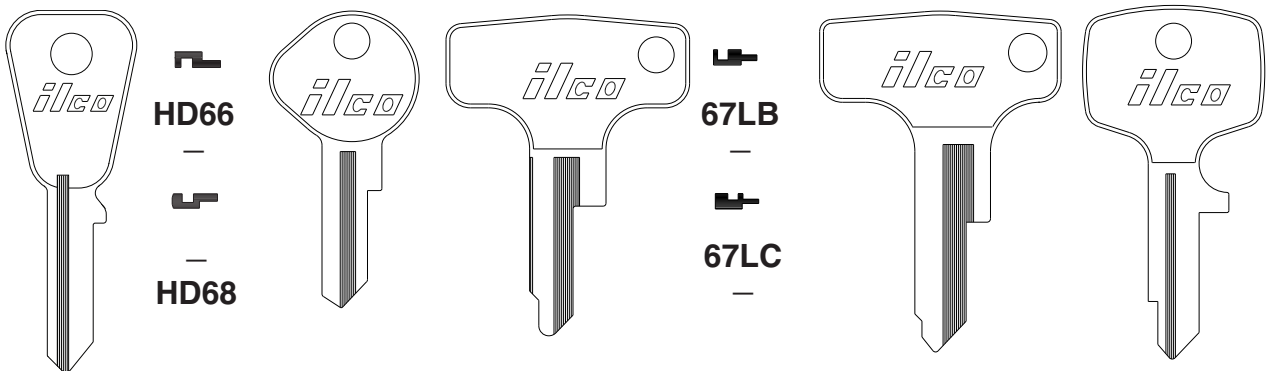

HD66	—	—	67LB	—	—
—		—	—	67LC	—
—	—	—	—	—	—
HD65	67H	67LA	67LD	B67K	—
—	—	—	—	—	—

ILCO
EZ

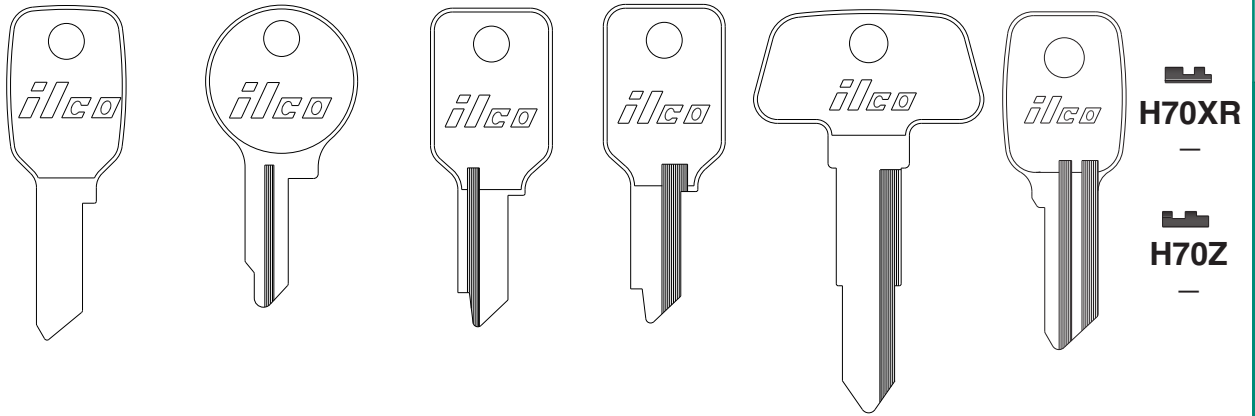
HONDA (MOTORCYCLES)

ILCO
EZ

C67K	D67K	U67K	U67KR	HD69	H70X
—	—	—	—	—	—

sec 1 page 67

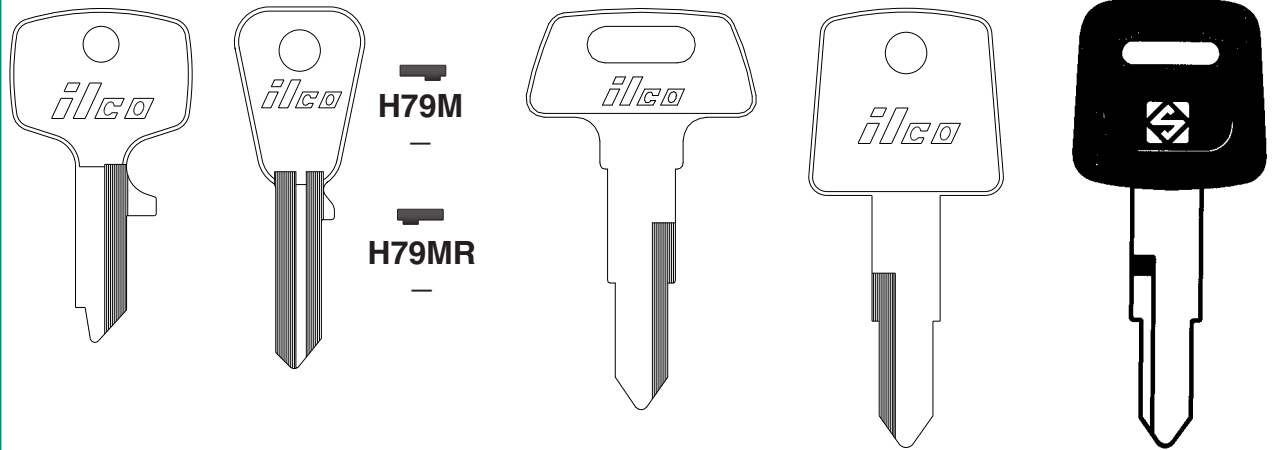
VEHICLE

HONDA (MOTORCYCLES)

ILCO
EZ

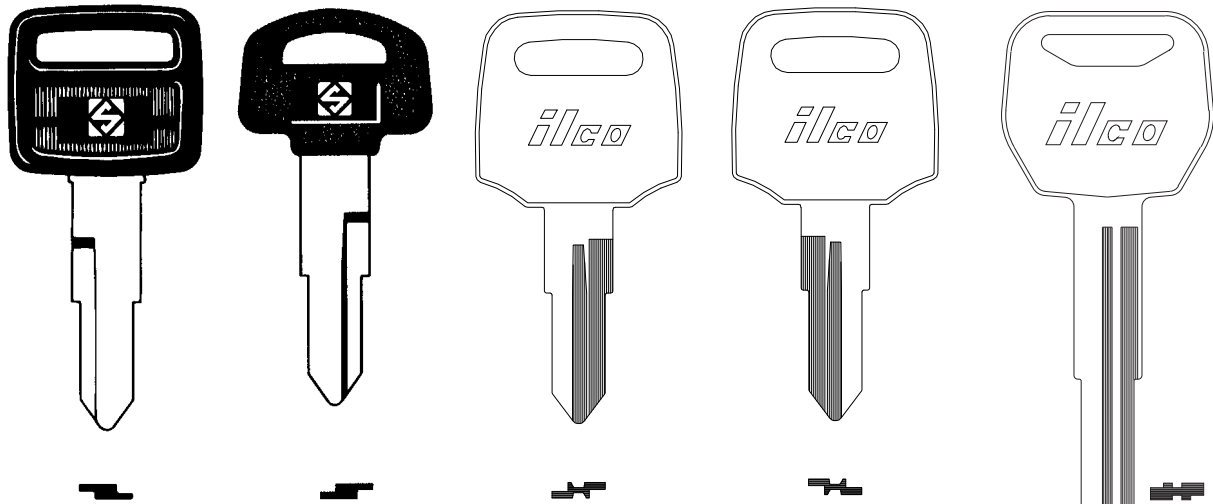
H73Z	H77P	H77PR	X84	X138	HON31P
—	—	—	HD74	HD75	—

HONDA (MOTORCYCLES)

ILCO
EZ

HON31AP	HON31BP	X246	X252	X265
—	—	HD105	HD108	HD109

HONDA (MOTORCYCLES)

VEHICLE

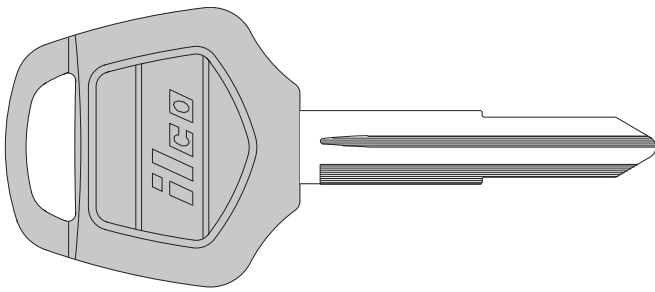
sec 1 page 68



HD110-P
—

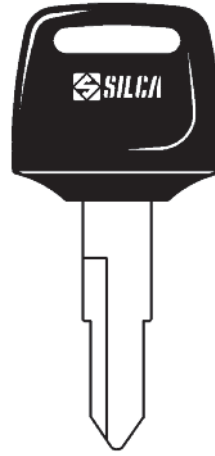

HON31CP-SI
—

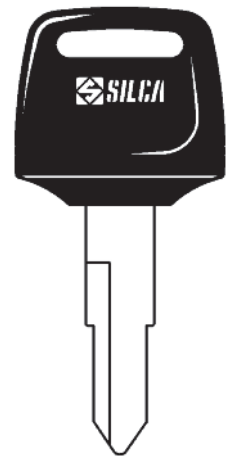

HON31RCP-SI
—

ILCO
EZ

HONDA (MOTORCYCLES)

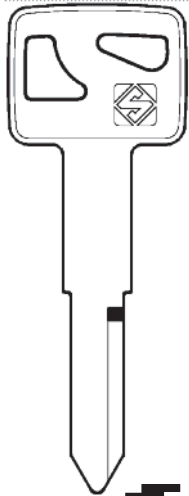

HON41-SI
—

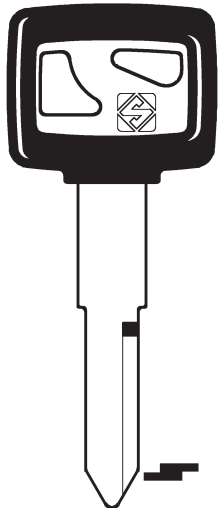

HON41P-SI
—

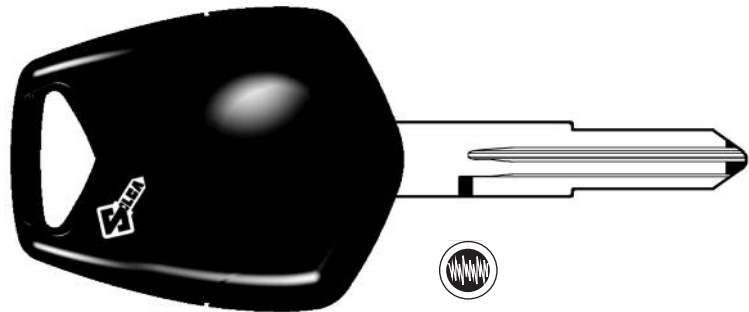

HON58REHP-SI
—

ILCO
EZ

HONDA (MOTORCYCLES)



HON64BP-SI
—



HON64RBP-SI
—

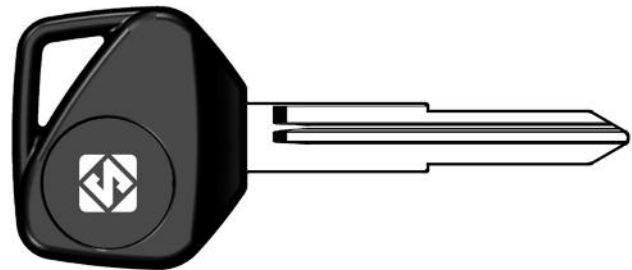

HON70T14-SI
—

ILCO
EZ

HONDA (MOTORCYCLES)**ZD24RDP-SI**

—

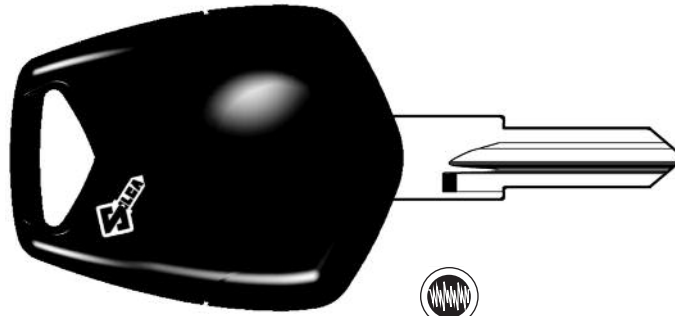
**HON70EHP-SI**

—

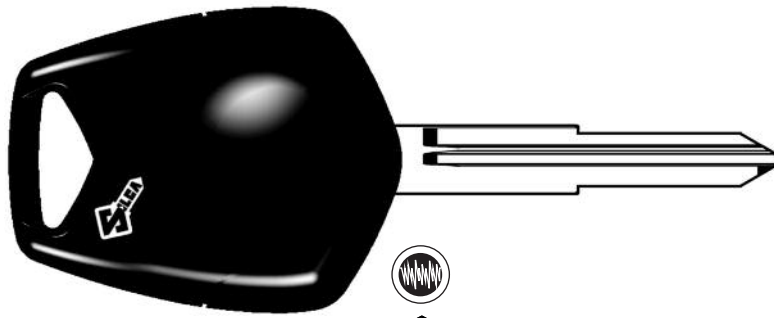
ILCO
EZ**HONDA (MOTORCYCLES)****ZD24REHP**

—

**ZD24RT14-SI**

—

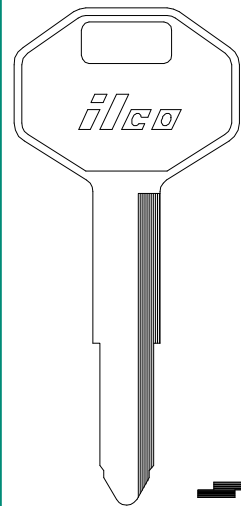
HYUNDAI**X121**

DC3

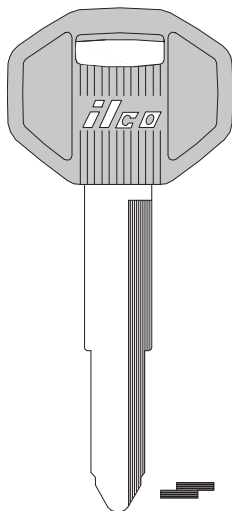
ILCO
EZ**HYUNDAI****DC3-P (-PC)**

—

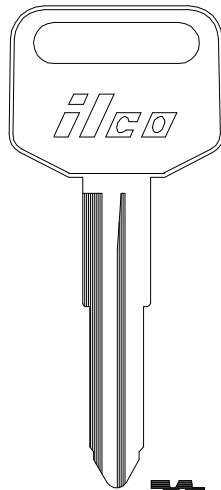
**X160**

HY2

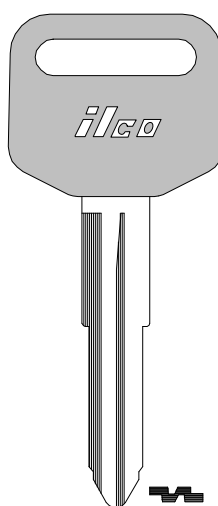
**HY2-P**

—

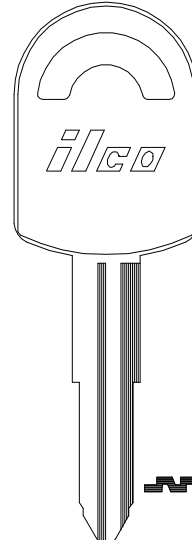
**X161**

HY3

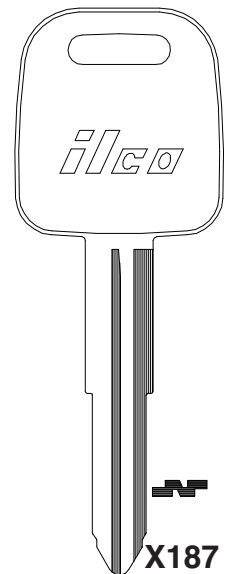
**X187**

HY4

ILCO
EZ

HYUNDAI

VEHICLE

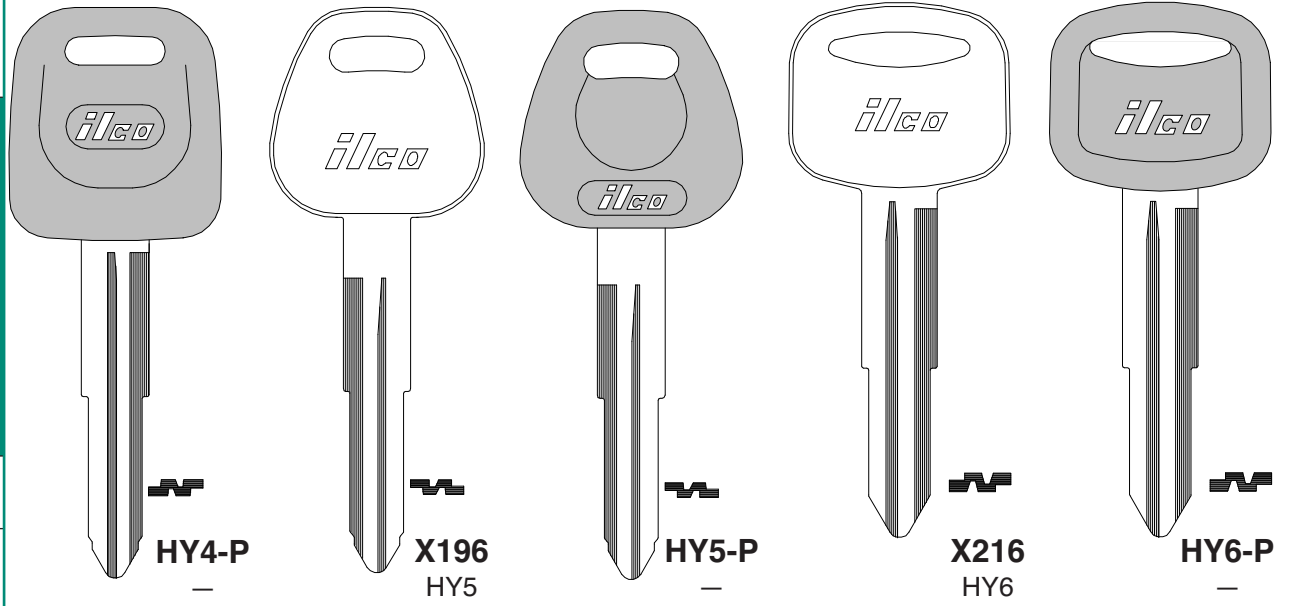

ILCO
EZ

HYUNDAI

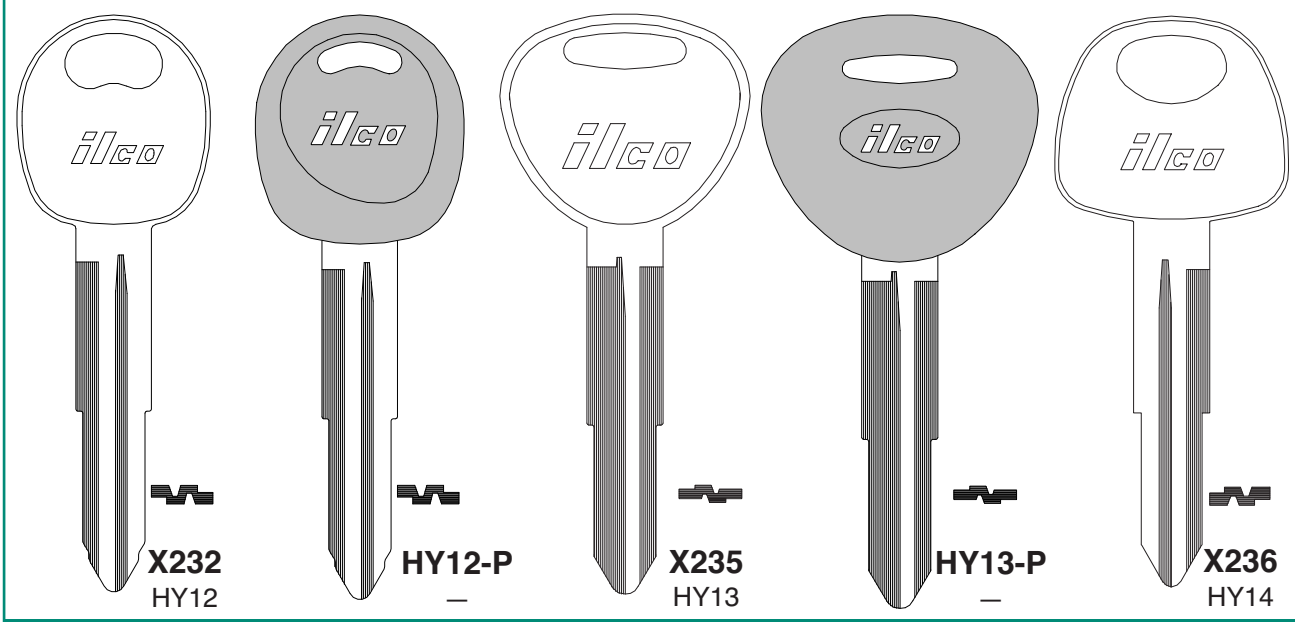

ILCO
EZ

HYUNDAI

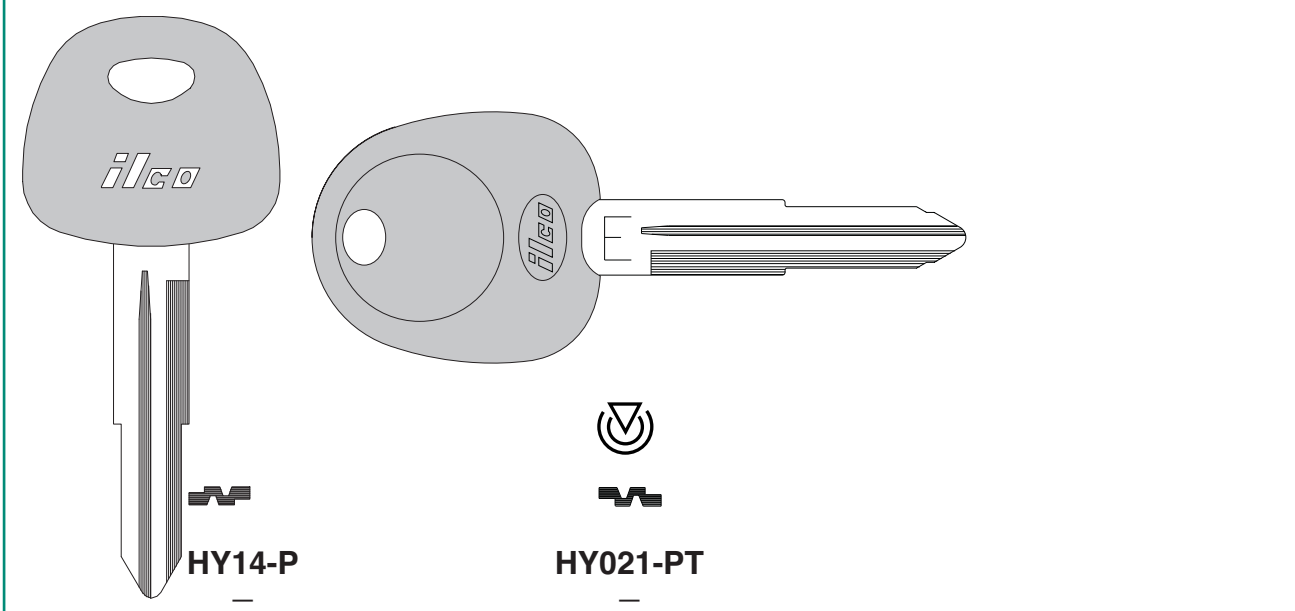

ILCO
EZ

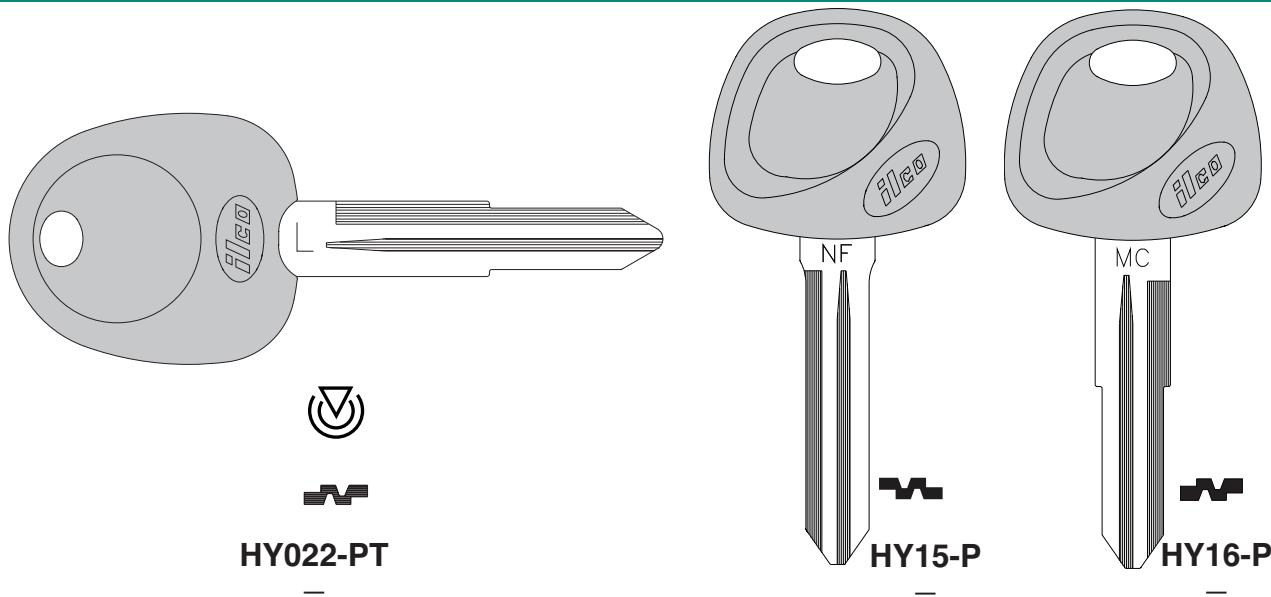
HYUNDAIILCO
EZHY022-PT
—HY15-P
—HY16-P
—sec
1 page
71

VEHICLE

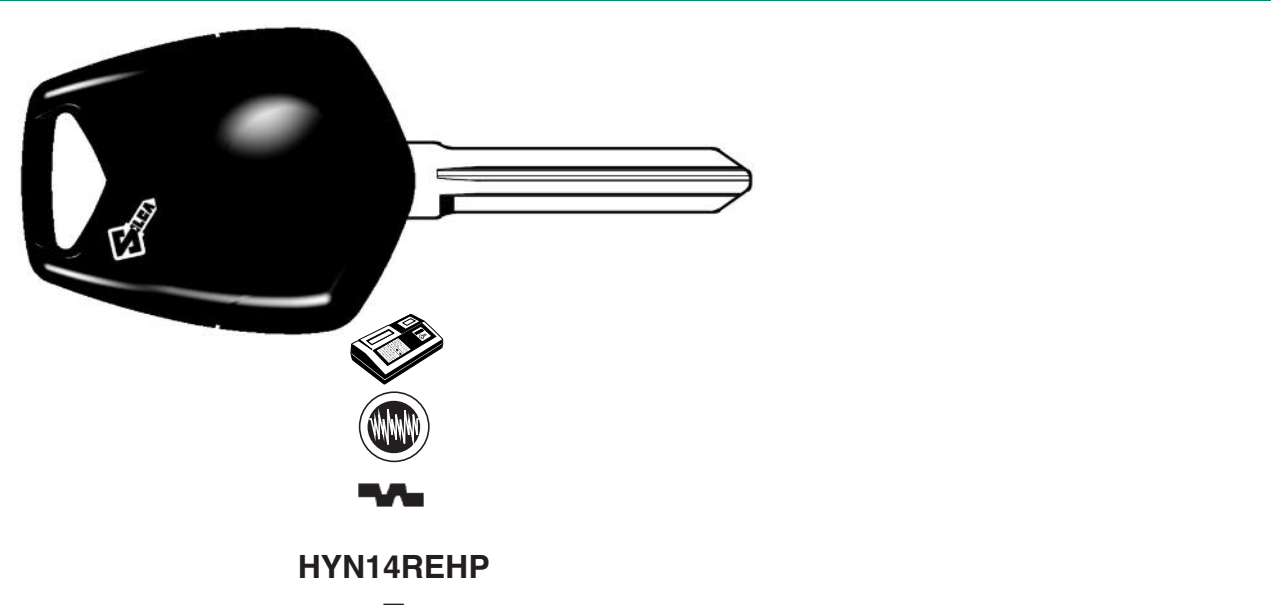
HYUNDAIILCO
EZHY17-P
—HY20-PT
—HYN6EHP
—**HYUNDAI**ILCO
EZHYN14REHP
—

HYUNDAI

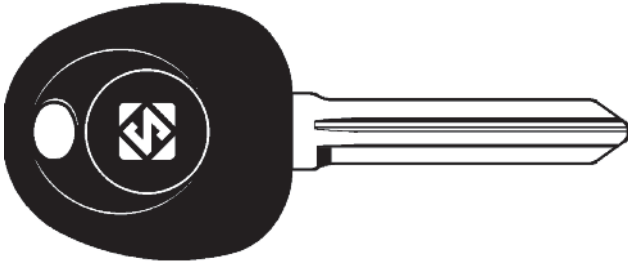

HYN14RT14

—

ILCO
EZ

HYUNDAI

INDAK

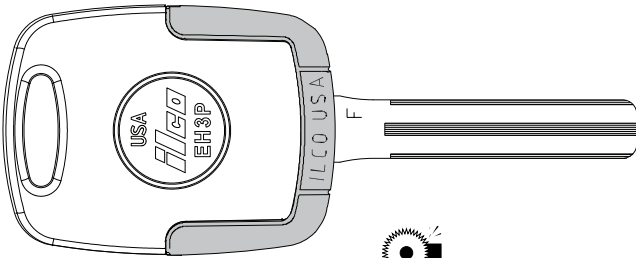

EK3P-HY20
(Complete Key)

EH3P
(Head Only)

EB3-F-TOY48
(Blade Only)

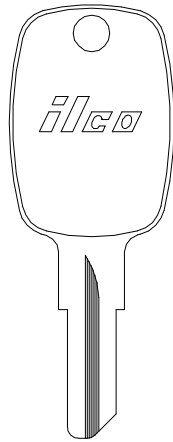

1098JD

—

ILCO
EZ

INDAK

INDIAN

INFINITI/NISSAN

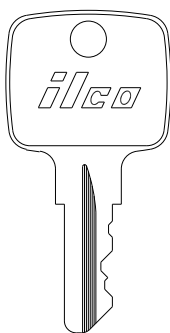

C1098JD

—



1148

—

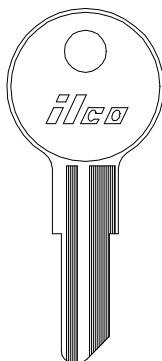

1041T
CG16

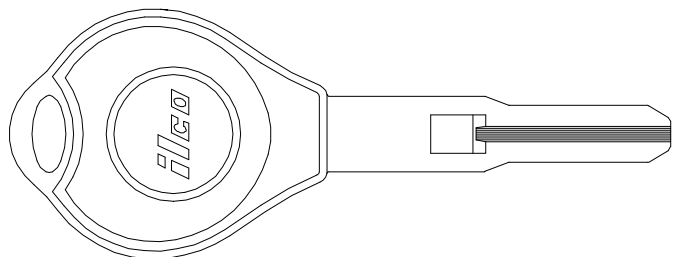

INF90

—

ILCO
EZ

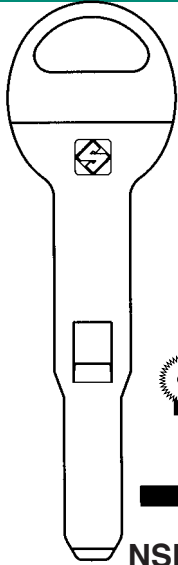
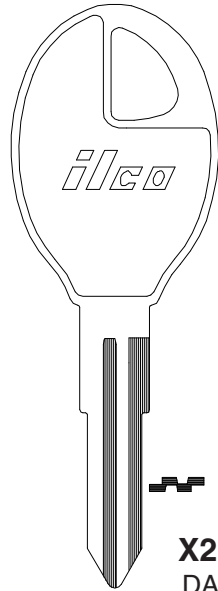
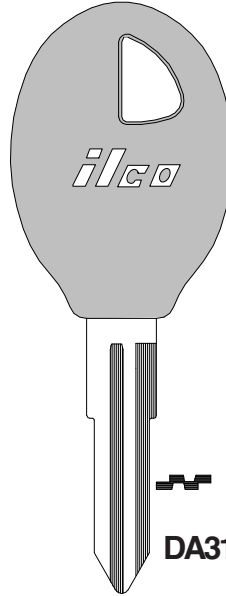
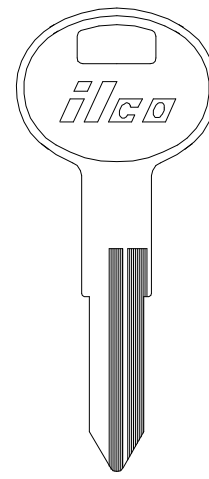
INFINITI/NISSAN**NSN10**VALET FOR
INF90**X210**
DA31**DA31-P (-PC)****X124**
DA28

VALET FOR X210 AND DA431-P (-PC)

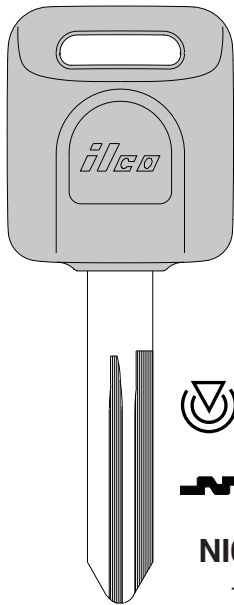
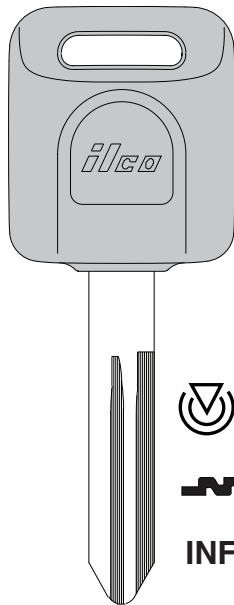
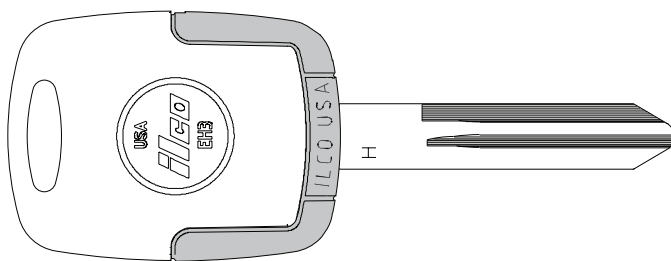
ILCO
EZ**INFINITI/NISSAN****NI04T****INF45-PT**ILCO
EZ**INFINITI/NISSAN****EH3**
(Head Only)**EB3-H-NI02**
(Blade Only)**NI02-EK3**
(Complete Key)ILCO
EZ

INFINITI/NISSAN

VEHICLE

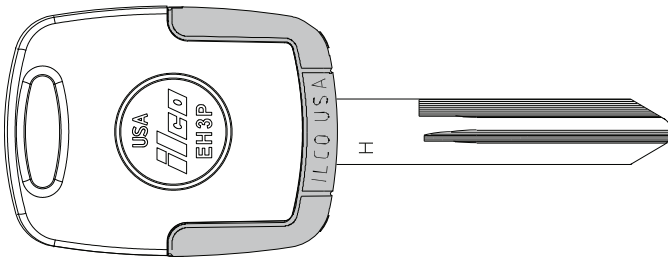

EH3P
(Head Only)

EB3-H-NI02
(Blade Only)



NI05
—

EK3P-NI04
(Complete Key)

ILCO
EZ

sec 1 page 74

ISETTA

ISUZU



FV1
—

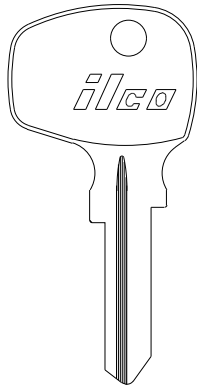

MB5
—

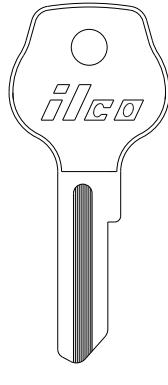

R62VB
—

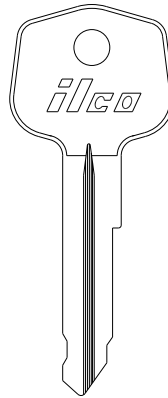

63E
—

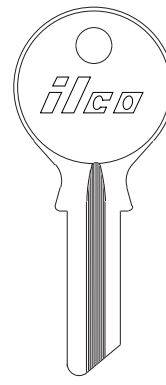

63L
—

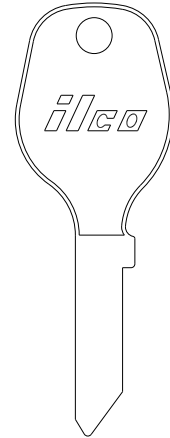

SZ1
—

ILCO
EZ

ISUZU

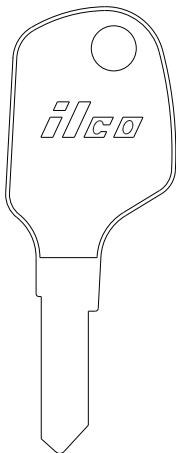

SZ2
—

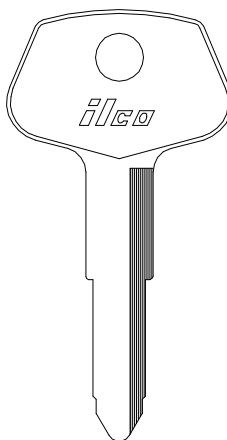

X54
DC1

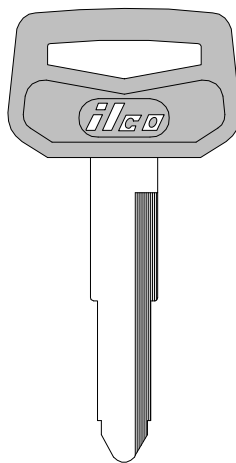

DC1-P
—

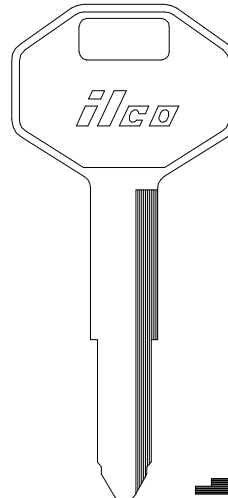

X121
DC3

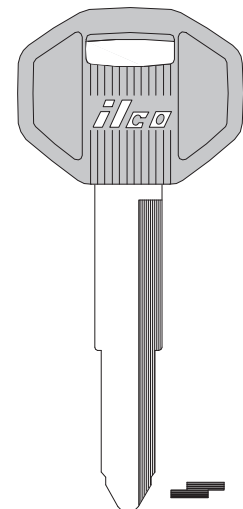

DC3-P (-PC)
—

ILCO
EZ

ISUZU

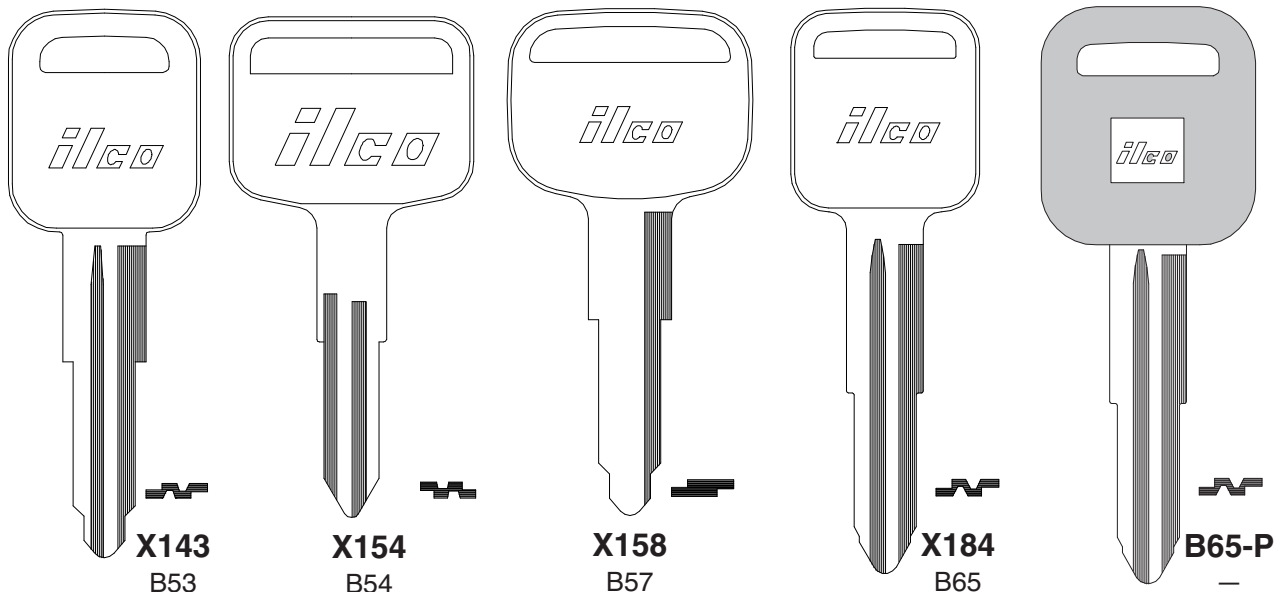
 ILCO
EZ

X143
B53

X154
B54

X158
B57

X184
B65

B65-P
—

ISUZU

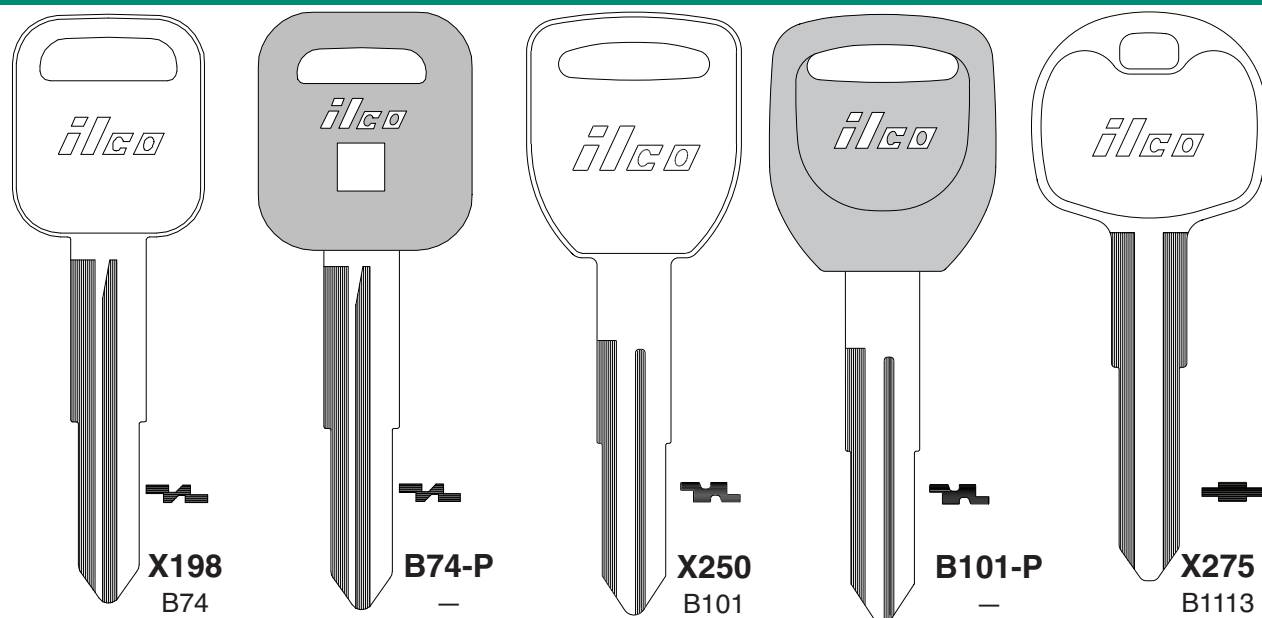
 ILCO
EZ

X198
B74

B74-P
—

X250
B101

B101-P
—

X275
B1113

ITALJET

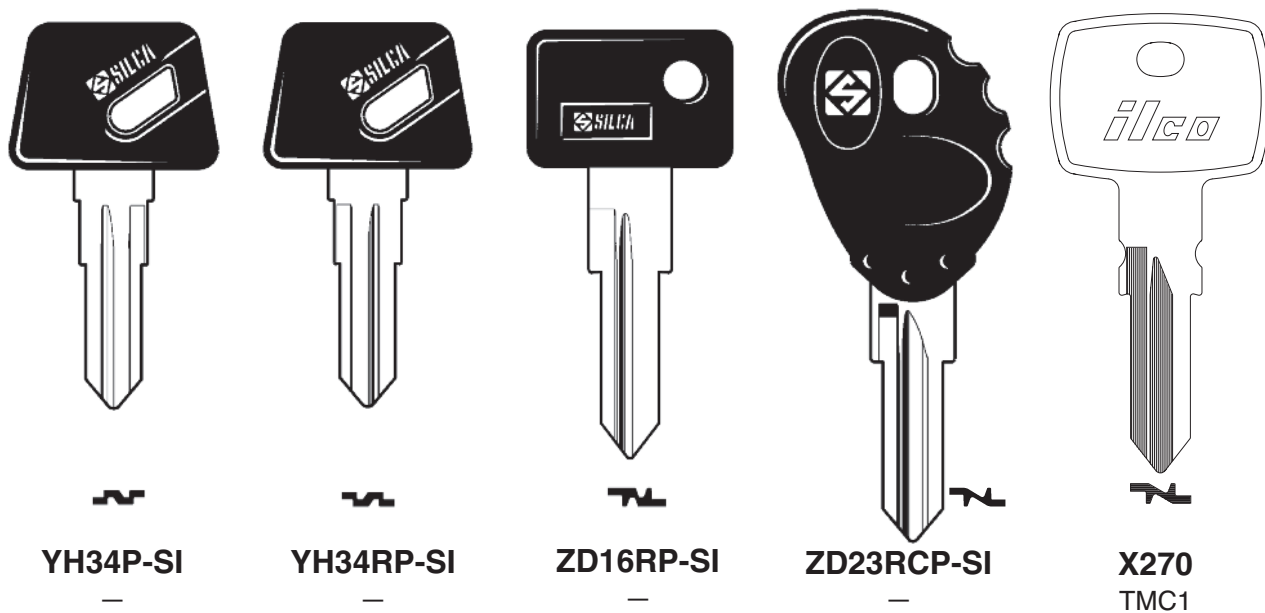
 ILCO
EZ

YH34P-SI
—

YH34RP-SI
—

ZD16RP-SI
—

ZD23RCP-SI
—

X270
TMC1

IVECO

JAGUAR

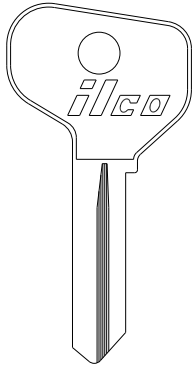

FT37
—

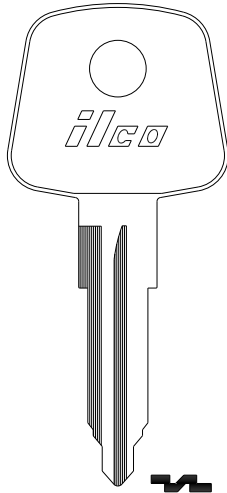

X50
AA3

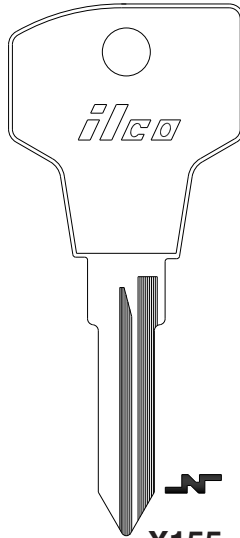

X155
IV1

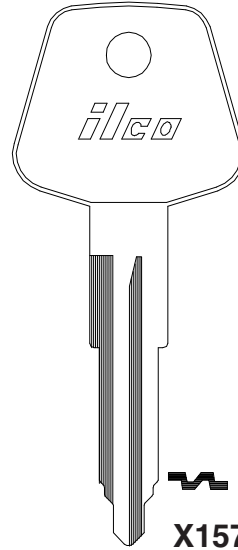

X157
LF17

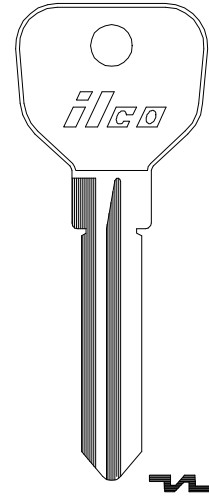

MG1
—

ILCO
EZ

JAGUAR

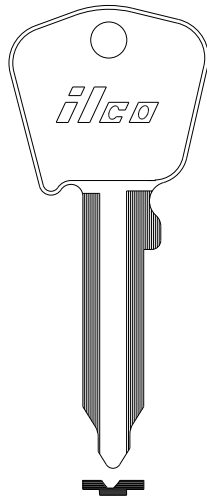

KL2
—

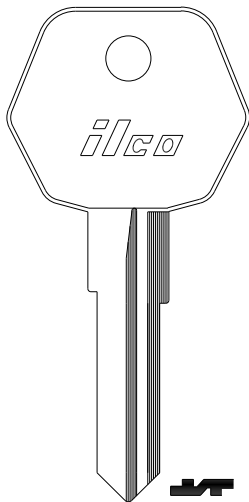

WB2
—

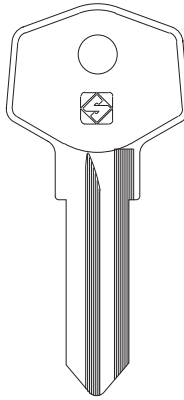

CEM5
—

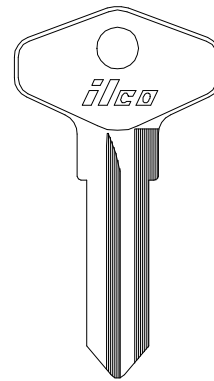

BL6
—

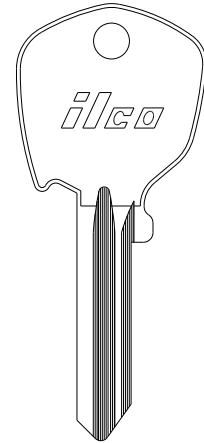

FT6R
F81E

ILCO
EZ

JAGUAR

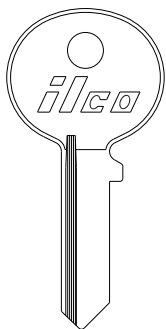

UN16
—

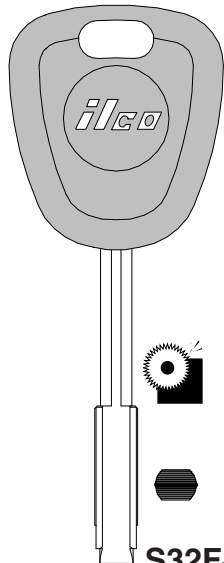

S32FJ-P
—

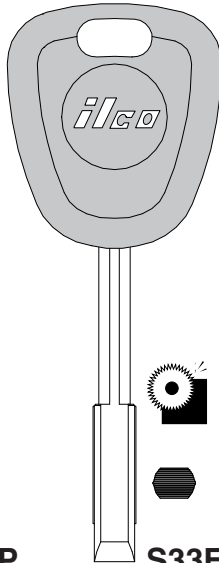

S33FJ-P
—

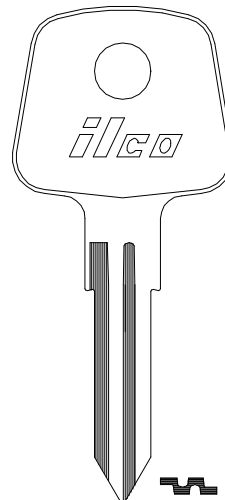

X51
AA2

ILCO
EZ

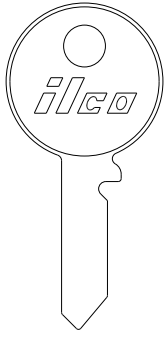
JAGUAR

62DG

-

62DH

-

62DK

-

62DM

-

62DP

-

R62DM

-

62DX

-

62FS

-

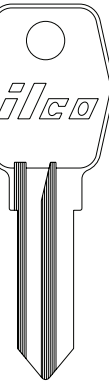
62FG

-

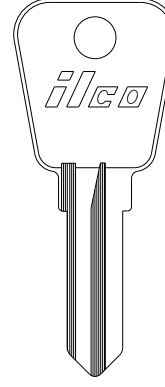
62FT

F68YT

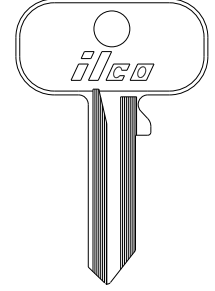
B62DR

-

B62DP

-

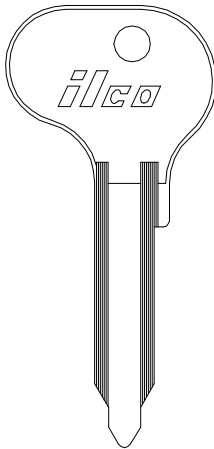
**ILCO
EZ**
JAGUAR

VW77

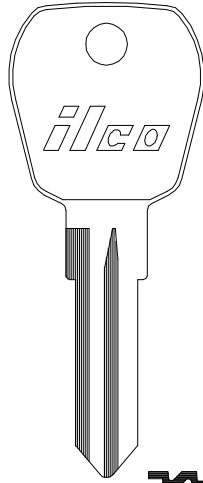
-

X86

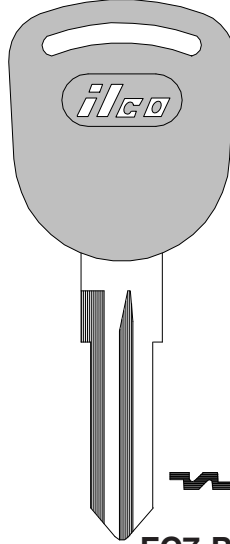
FC7

FC7-P

-

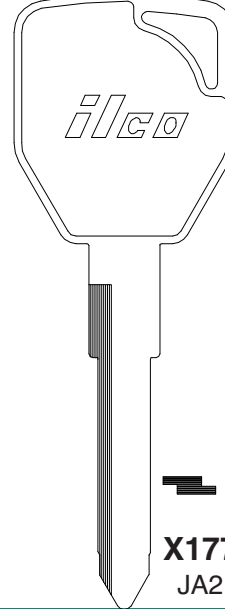
X177

JA2

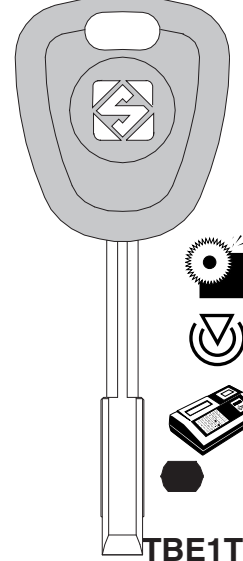
TBE1T5

-

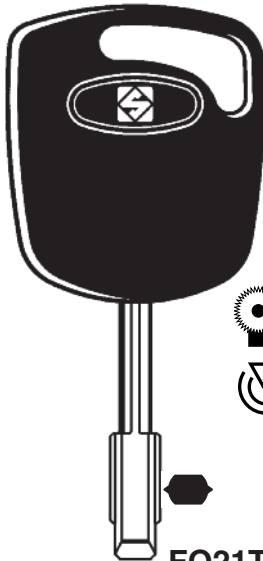
**ILCO
EZ**
JAGUAR
JAWA CYCLE

FO21T7-SI

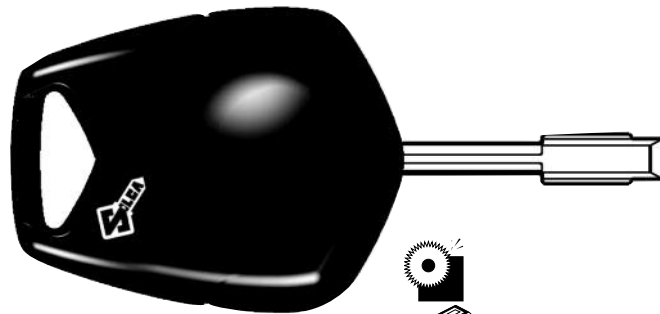
-

FO21EH2

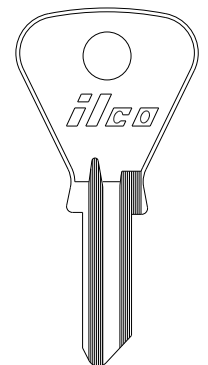
-

J66M

-

**ILCO
EZ**

JEEP

JOHN DEERE

SEE
AMERICAN
MOTORS
OR
CHRYSLER

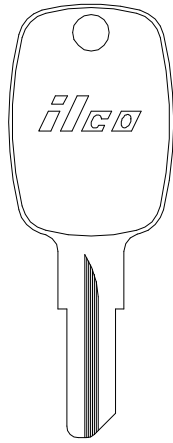

1098JD

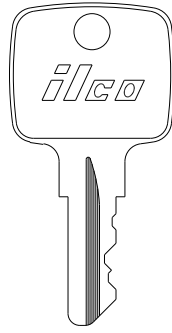

C1098JD

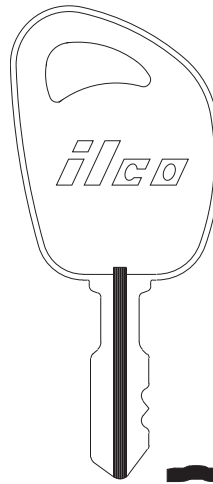

D1098JD

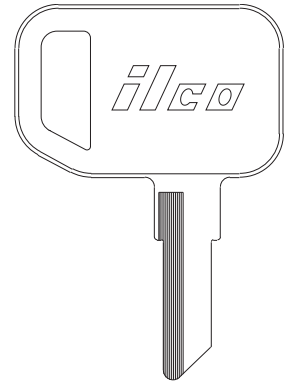

E1098JD

ILCO
EZ

JOHN DEERE

JOHNSTON MOTORS

KAISER FRAISER

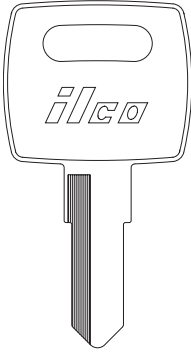

F1098JD

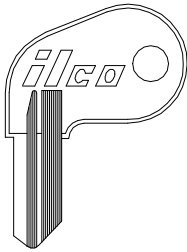

OM10

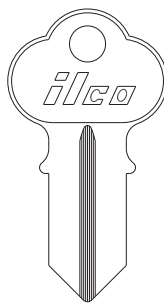

1041G
CG1

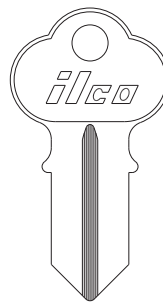

1041GA
CG2

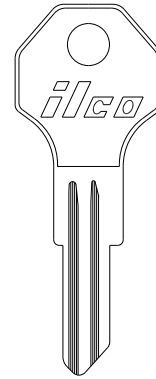

H122AL



H122ALR

ILCO
EZ

KAISER FRAISER

KAWASAKI

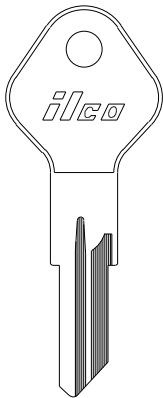

K122AR

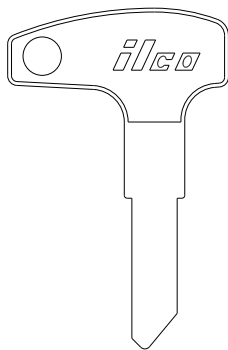

KA1



KA2



KA3

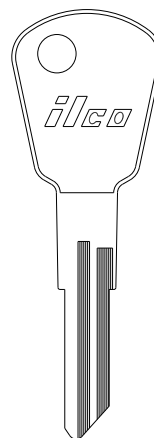

KA4



KA8

ILCO
EZ

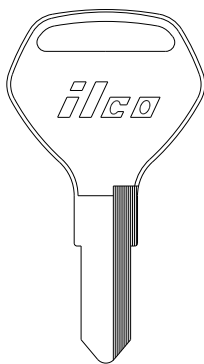
KAWASAKI

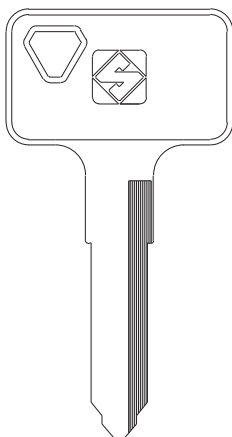
KA12
 —

KW14
 —

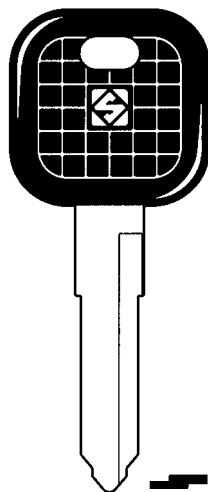
KW14R
 —

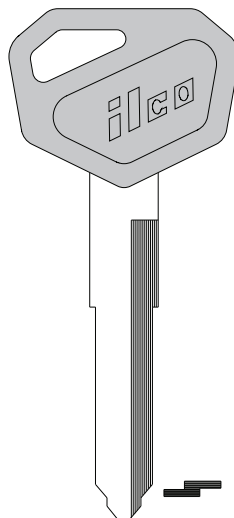
KW14AP
 —

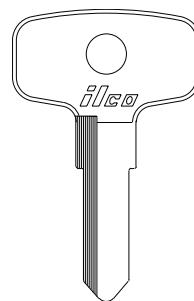
KW15BP
 —

X18
 YH21

ILCO
 EZ

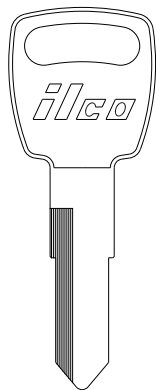
KAWASAKI

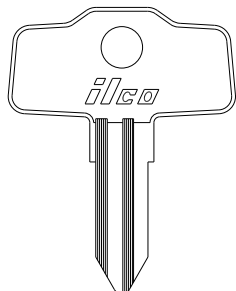
X24
 KA7

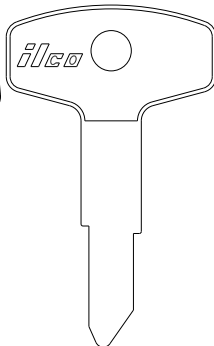
X40
 KA5

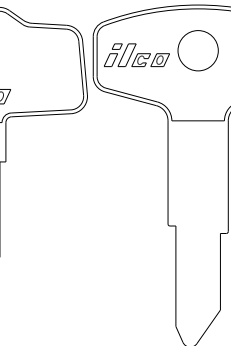
X34
 —

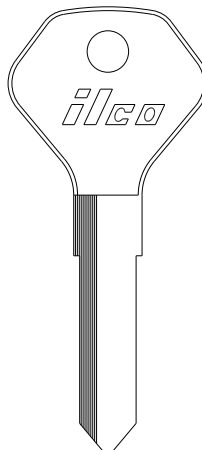
X41
 —

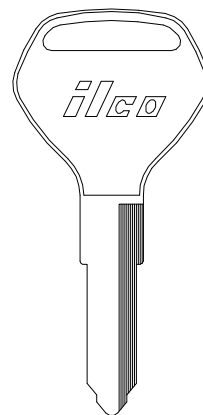
X35
 —

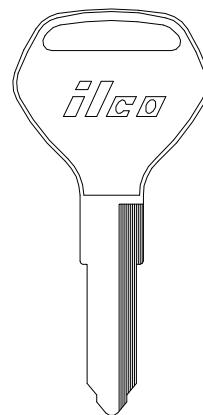
X90
 —

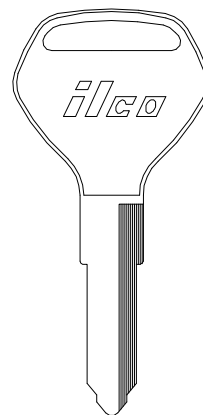
X91
 —

X103
 KA14

ILCO
 EZ

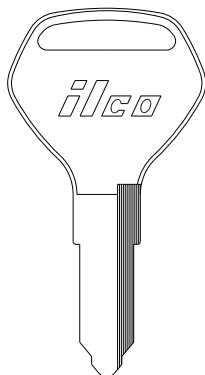
KAWASAKI

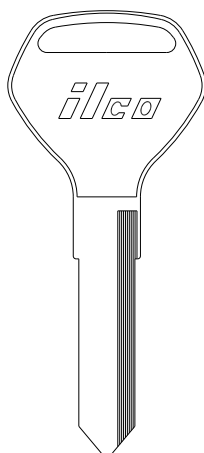
X104
 KA13

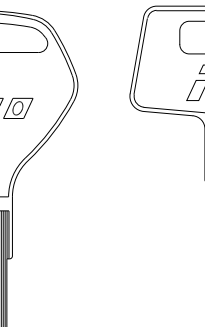
X105
 KA11

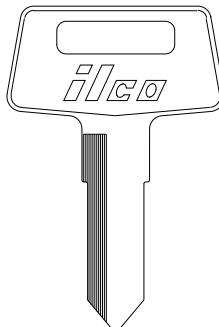
X106
 KA15

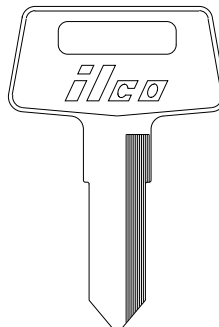
X254
 —

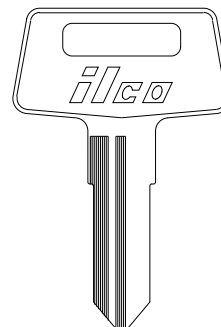
X255
 —

X256
 —

ILCO
 EZ

KAWASAKI

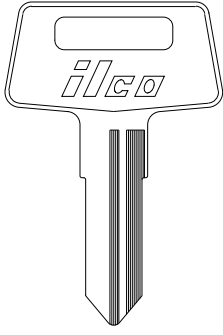

X257

—

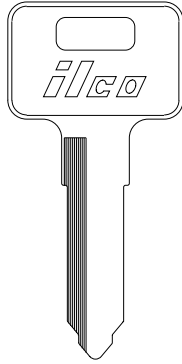

X258

—

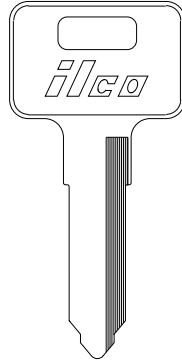

X259

—

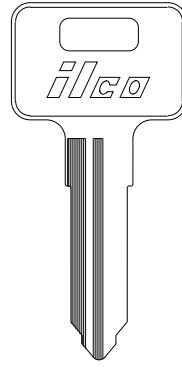

X260

—

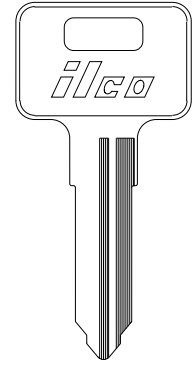

X261

—

ILCO
EZ

KAWASAKI

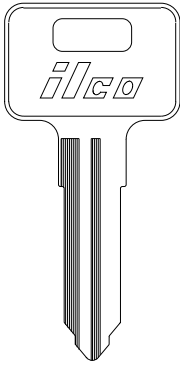

X262

—

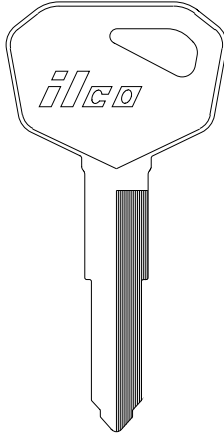

X266

KA16

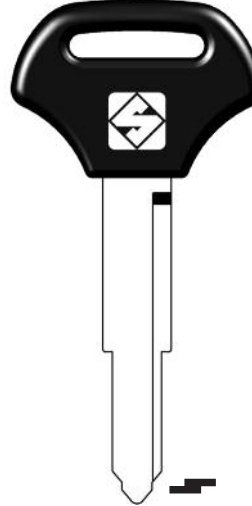

KW16CP-SI

—

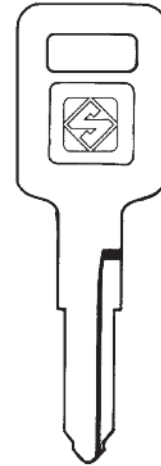

KW12-SI

—

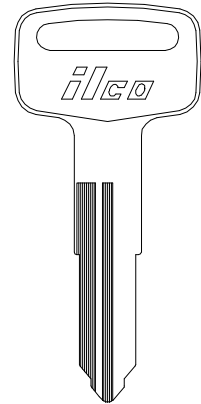

X117

YH48

ILCO
EZ

KAWASAKI

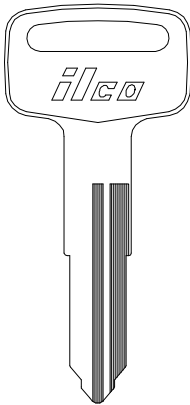

X118

YH49

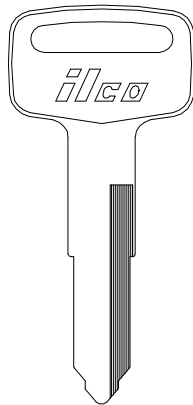

X119

YH47

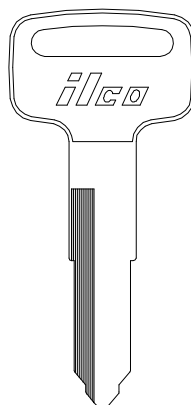

X120

YH46

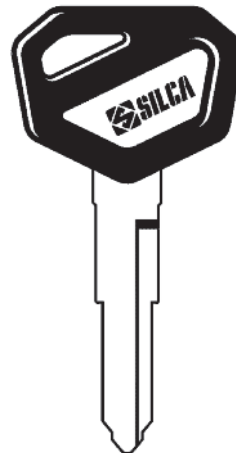

KW12BP-SI

—

ILCO
EZ

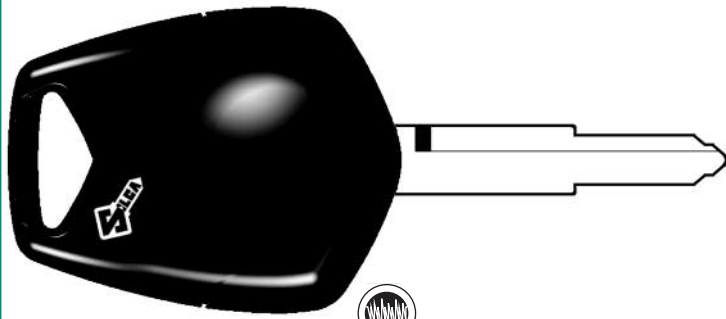
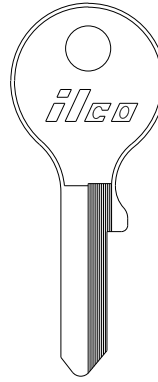
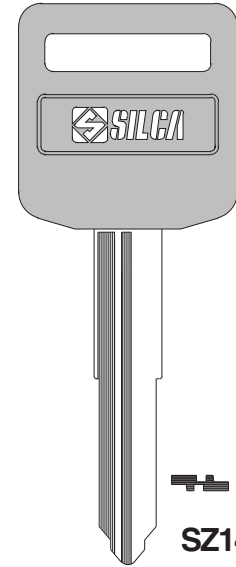
KAWASAKI

KW16EH2
—

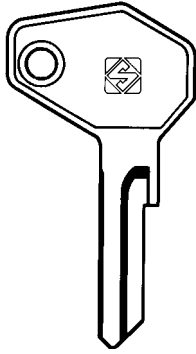
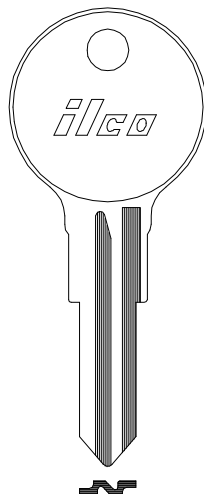
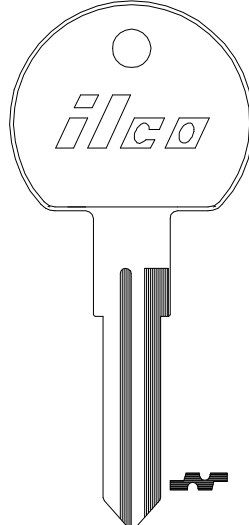
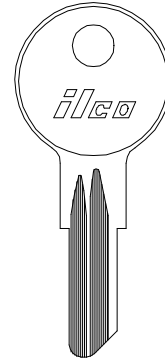
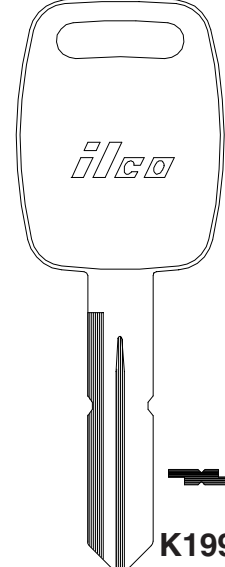
SR61N
—

SZ14RAP
—

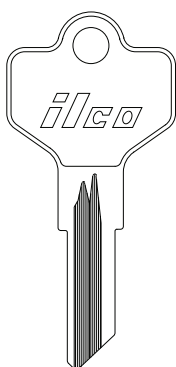
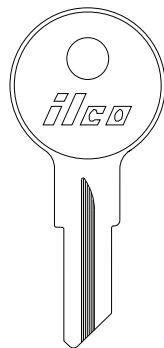
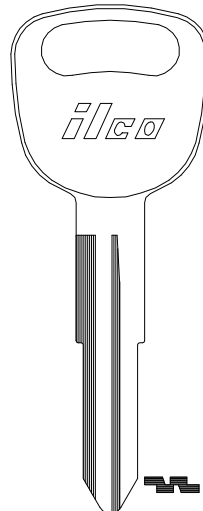
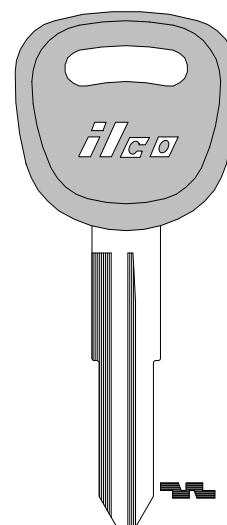
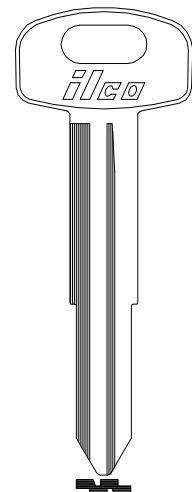
ILCO
EZ

KAWASAKI
KENWORTH

ZD7-SI
—

X53
V32

X170
NE48

1098DB
B5

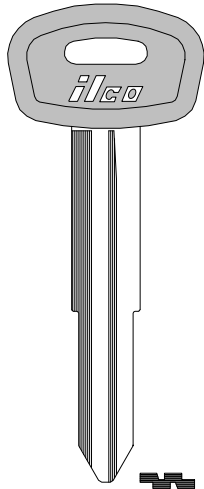
K1994
—

ILCO
EZ

KENWORTH
KIA

1656
—

1657
—

X233
KK1

KK1-P
—

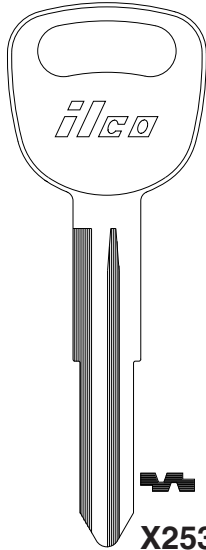
X240
KK2

ILCO
EZ

KIA



KK2-P
—



X253
KK3

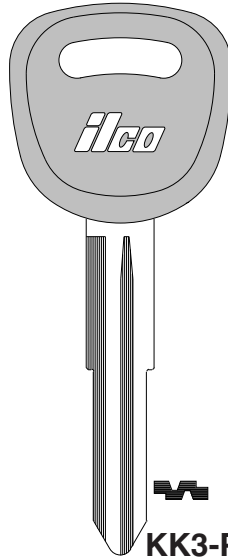

KK3-P
—

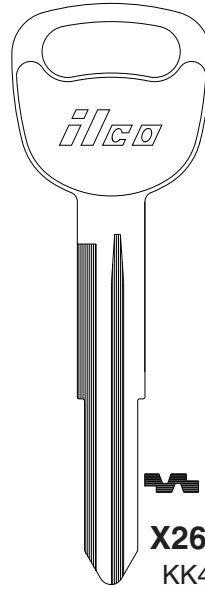

X267
KK4

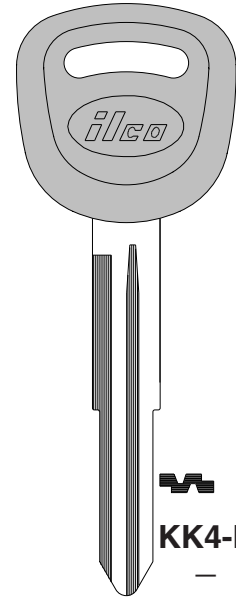

KK4-P
—

ILCO
EZ

KIA

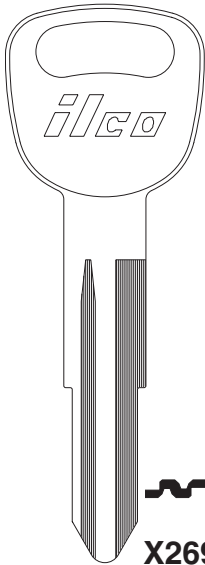

X269
KK5

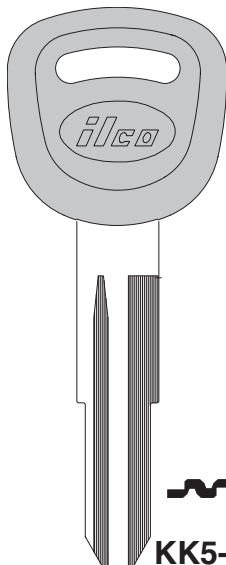

KK5-P
—

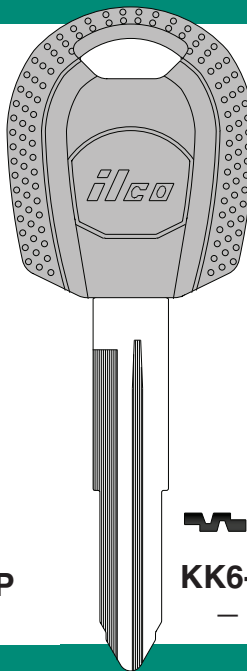

KK6-P
—

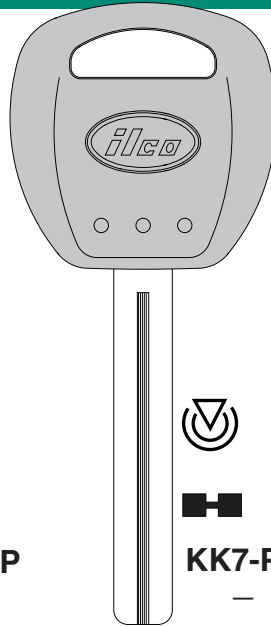

KK7-PT
—

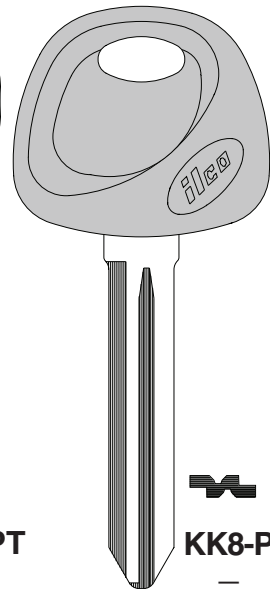

KK8-P
—

ILCO
EZ

KIA

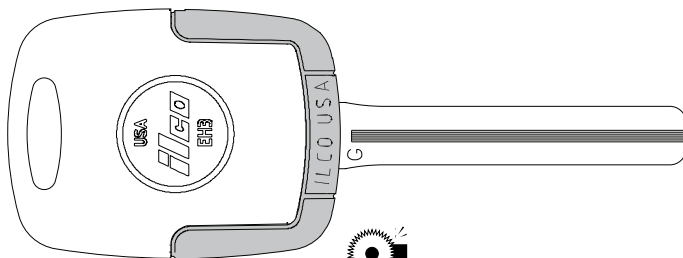

TOY40-EK3
(Complete Key)



EH3
(Head Only)

EB3-G-TOY40
(Blade Only)

ILCO
EZ

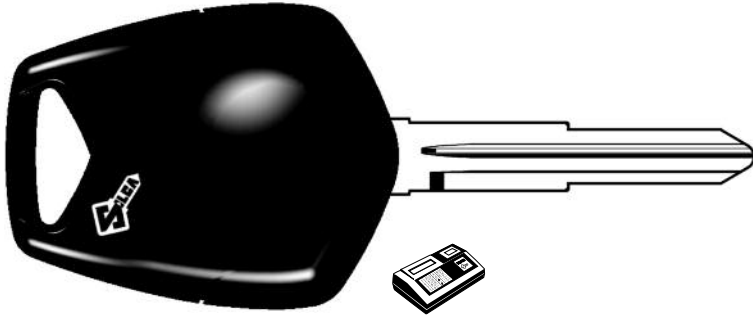
KIA**KIA3EHP**

—

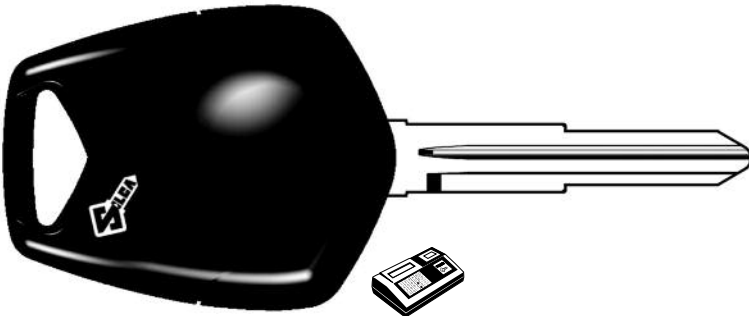
ILCO
EZ**KIA****KIA3REHP**

—

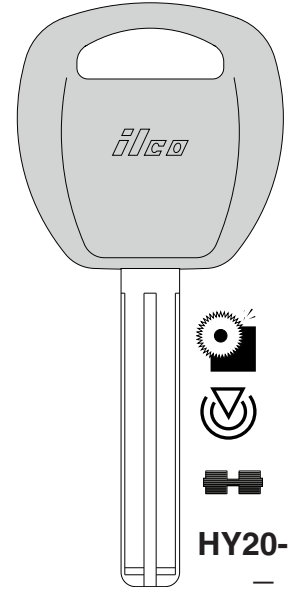
ILCO
EZ**HY20-PT**

—

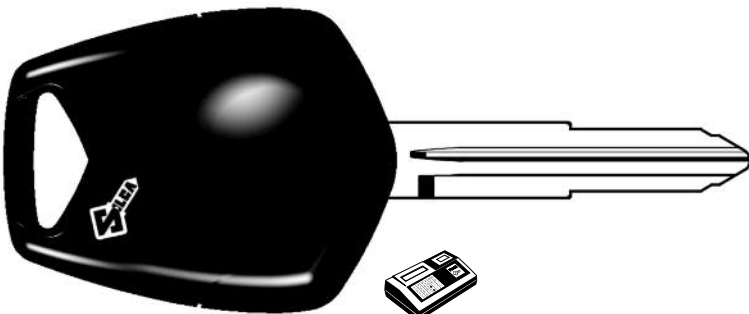
KIA**HYN7REHP**

—

ILCO
EZ

KIA

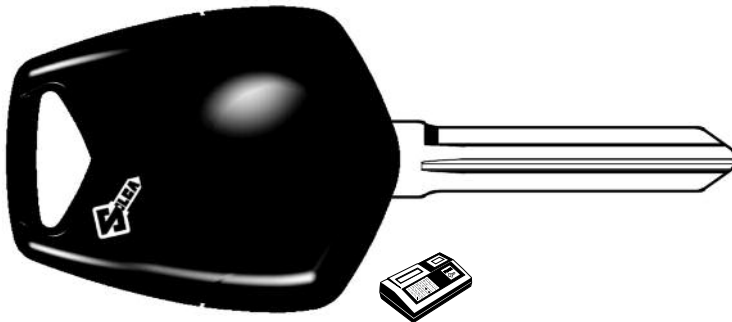

HYN14EHP

—

ILCO
EZ

KIA

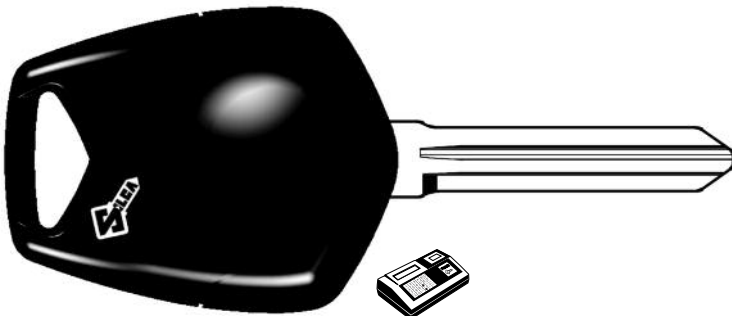

HYN14REHP

—

ILCO
EZ

KIA

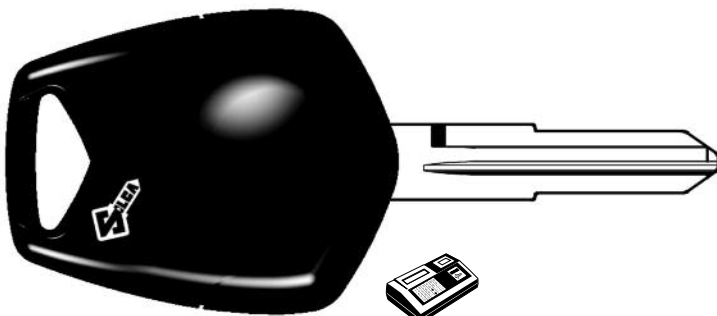

HYN15EHP

—

ILCO
EZ

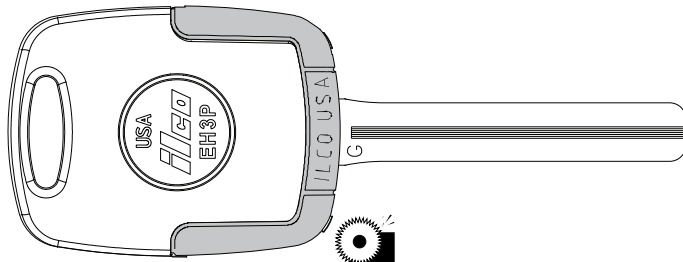
KIA
KOMATSU

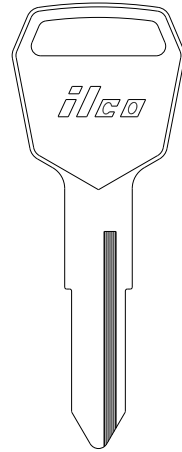
EH3P
(Head Only)

EB3-G-TOY40
(Blade Only)

1519
—

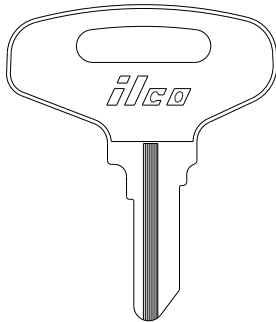
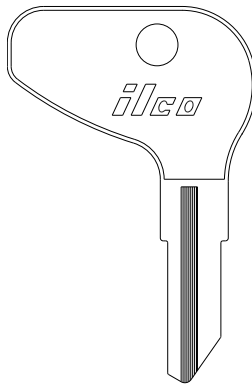
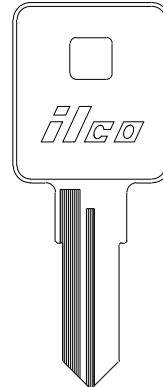
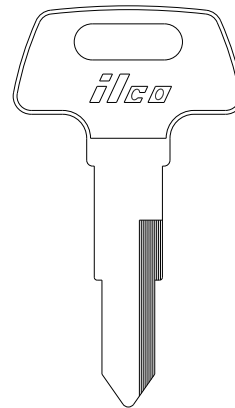
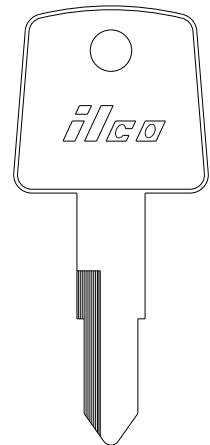
ILCO
EZ

EK3P-KK9
(Complete Key)

KUBOTA
KYMCO

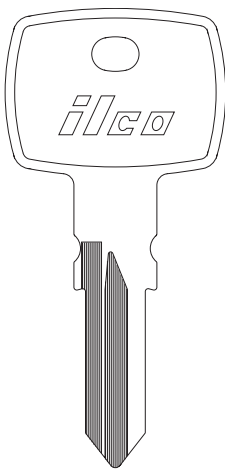
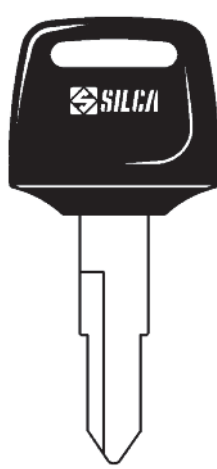
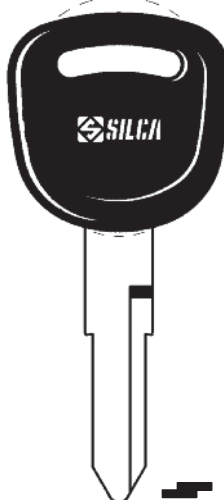
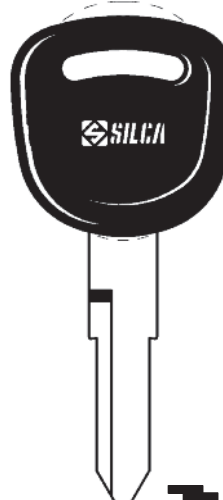
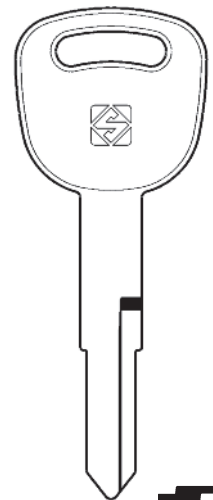
1539
—

1540
—

X234
HYD13

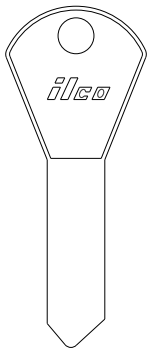
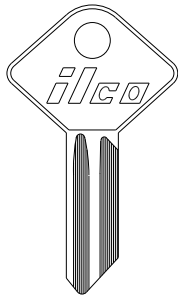
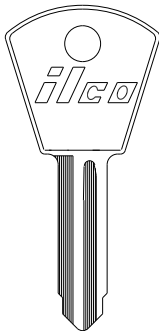
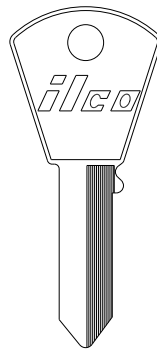
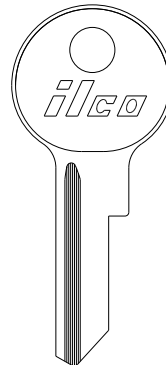
X84
HD74

X138
HD75

ILCO
EZ

KYMCO

X270
TMC1

HON31CP-SI
—

KYM1P-SI
—

KYM1RP-SI
—

KYM2-SI
—

ILCO
EZ

LAMBRETTA

LA1
—

LA2
—

LA3
—

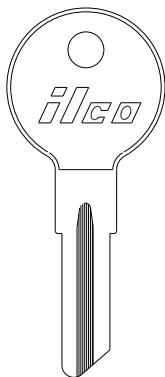
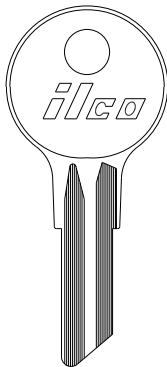
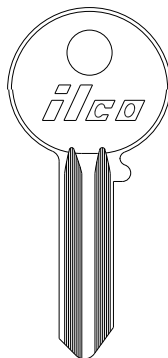
LA4
—

NE4
—

LA5
—

LA14
—

ILCO
EZ

LAMBRETTA

LA6
—

LA7
—

LA8
—

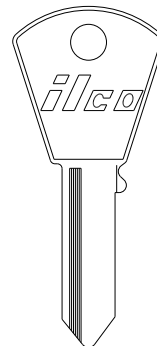
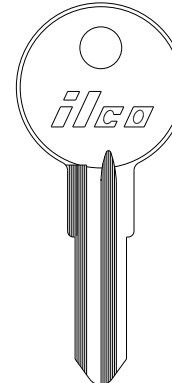
LA9
—

LA10
—

LA11
—

LA12
—

LA13
—

61H
—

R61H
—

ILCO
EZ

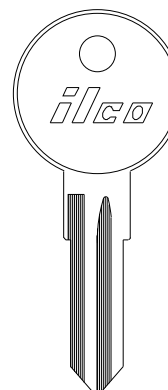
LAMBRETTA

H61N
—

62VA
—

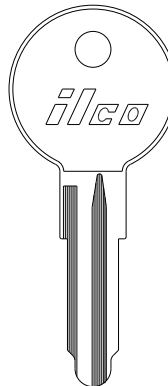
YR62
—

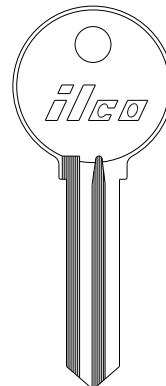
66A
—

66BB
—

125C
—

ILCO
EZ

LAMBRETTA	LANCIA					
125CR	GT1	GT2	GT3	GT4	LN4	SIP16T2
-	-	-	-	-	-	-
						61H R61H
						- -

ILCO EZ

LANCIA					
61N	61NA	62VA	63K	63W	64AL
-	-	-	-	-	-
	R61NA			R63K	64Y
	-			-	-

ILCO EZ

LANCIA	LAND ROVER	LAVERDA	LEXUS/TOYOTA	
	SEE ROVER			
F68C		ZD21P-SI	LXP90-P	LXV90-P
-		-	-	-
			LXP90-P	LXV90-P
			-	-

VALET FOR LXP90-P

ILCO EZ

LEXUS/TOYOTA

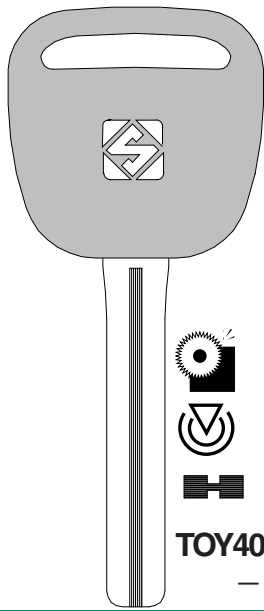

TOY40BT4

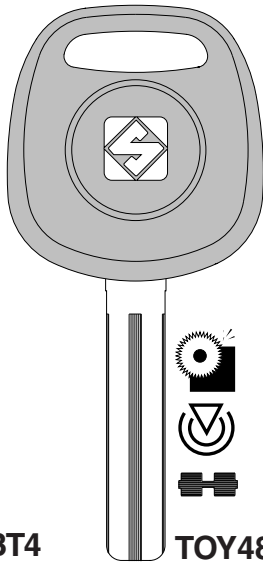

TOY48BT4

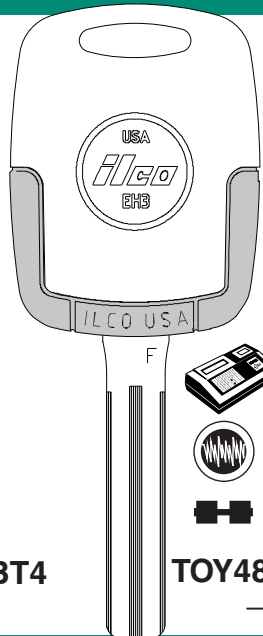

TOY48-EK3



EB3-F-TOY48
(Blade Only)

ILCO
EZ

LEXUS/TOYOTA

LINCOLN

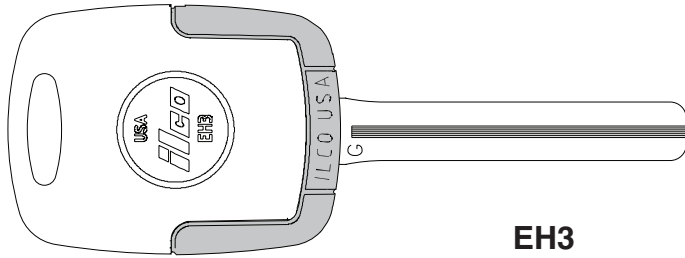

EH3
(Head Only)



EB3-G-TOY40
(Blade Only)

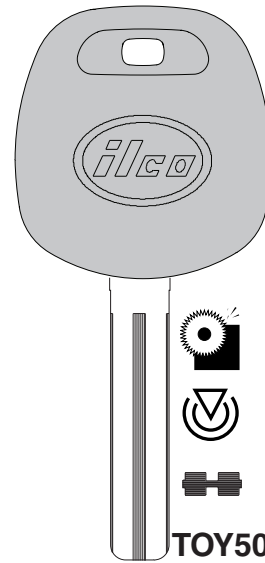

TOY50-PT

SEE
FORD

ILCO
EZ

LLOYD

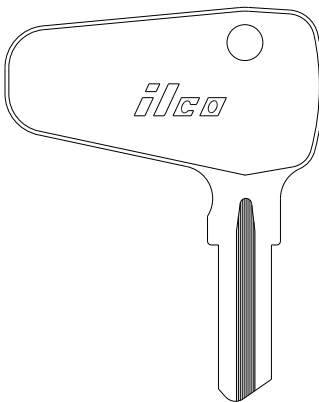

BH1

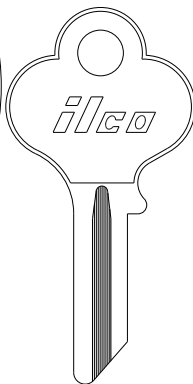

FV1

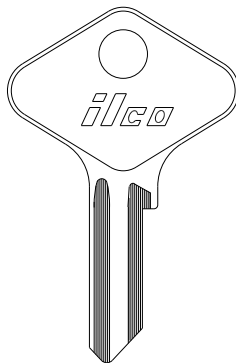

DM3

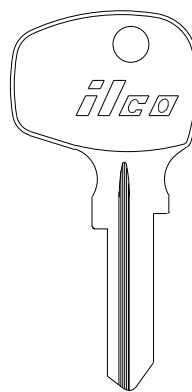

MB5

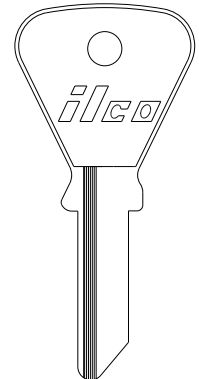

62VH

ILCO
EZ

LLOYD

S62VP	63	M63BG	63L	M63B	XD63
—	—	—	—	—	—

ILCO
EZ

LLOYD LOWE & FLETCHER MACK

138	LF5	LF7	LF8	LF24	L194	DAV10
—	—	—	—	—	—	—

ILCO
EZ

MACK MAGIRUS-DEUTZ

NE10	R62UC	X163	1098M	DAV10
—	—	BL11	B1	—

ILCO
EZ

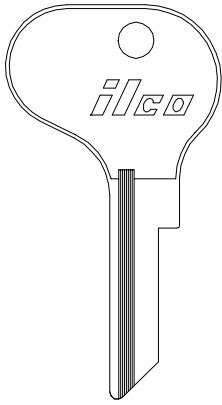
MAGIRUS-DEUTZ
MAGNETI-MARELLI

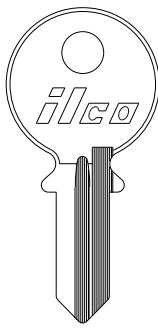
NE10
 —

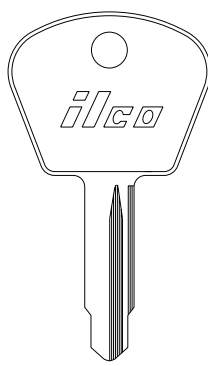
R62UC
 —

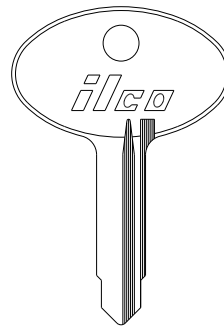
SP2
 —

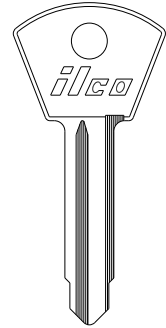
61D
 —

61F
 —

ILCO
 EZ

sec 1 page 91

VEHICLE

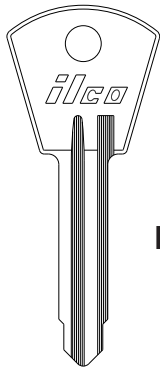
MAGNETI-MARELLI
MALAGUTI

L61D
 —

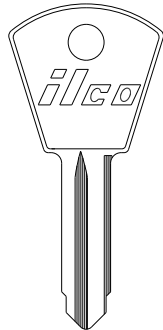
LR61D
 —

63ST
 —

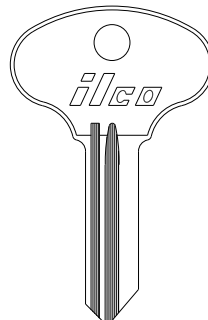

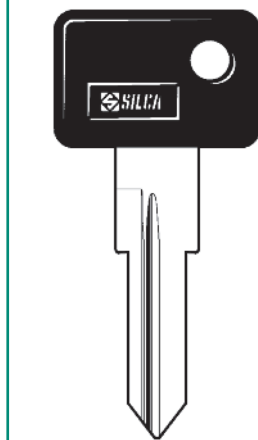
R63ST
 —

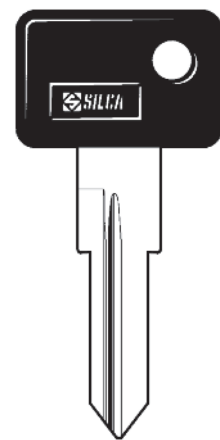
R63SP
 —

F91GS
 —

ZD16RP-SI
 —

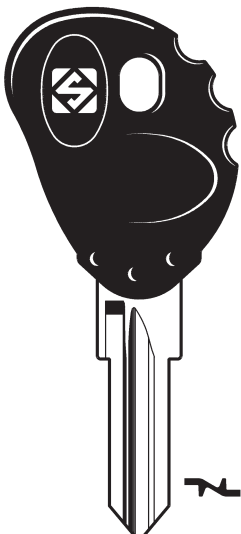
ILCO
 EZ

MALAGUTI
MASERATI

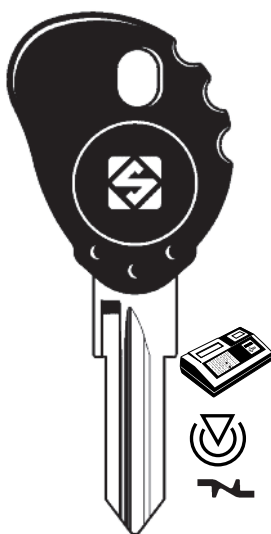
ZD23RCP-SI
 —

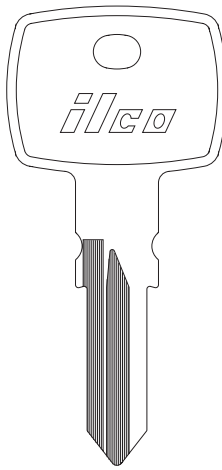
ZD23RT5-SI
 —

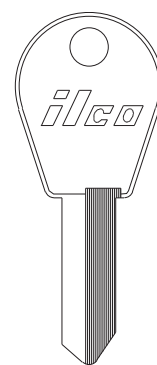
X270
 TMC1

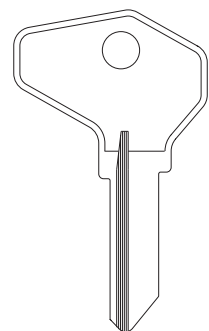



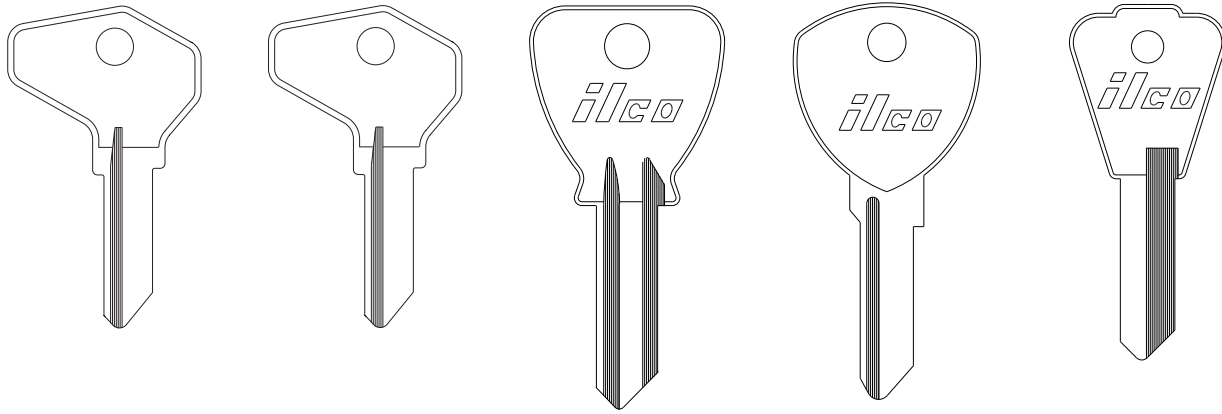

MAS1
 —

SF3-SI
 —

ILCO
 EZ

MASERATI









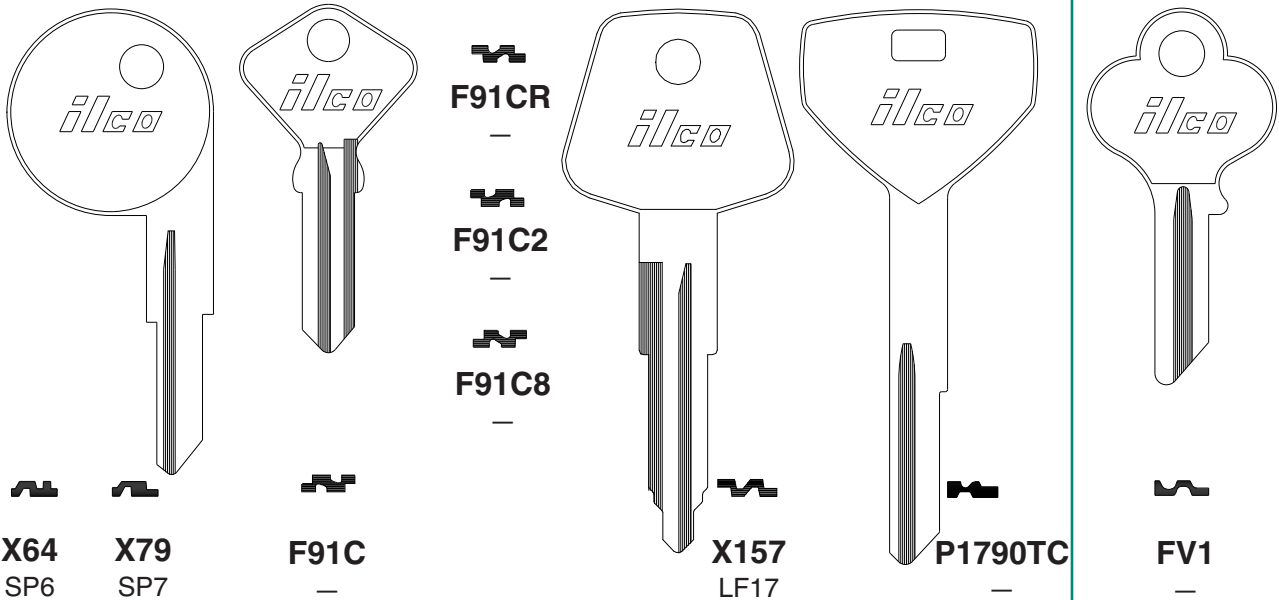

					
SF4-SI	SF5-SI	BO2	BO6	GT3	LN4
—	—	—	—	—	—

ILCO
EZ

MASERATI MATADOR



								
X64	X79	F91C	F91CR	F91C2	F91C8	X157	P1790TC	FV1
SP6	SP7	—	—	—	—	LF17	—	—

ILCO
EZ

MATADOR MAZDA

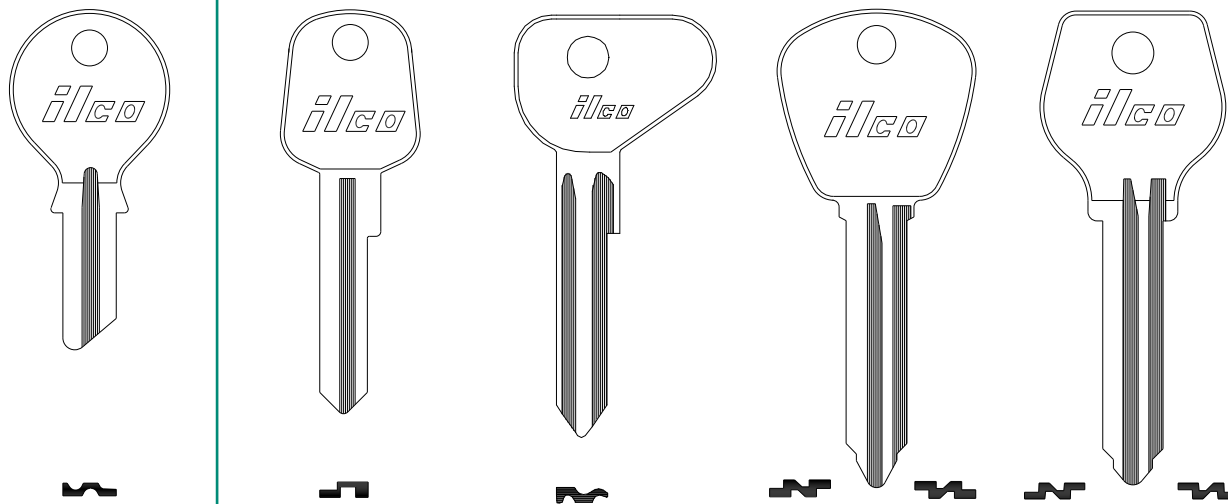

						
63	MZ1	X1	X2	X3	X4	X5
—	—	MZ12	MZ3	MZ2	MZ4	MZ5

ILCO
EZ

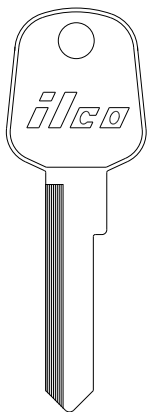
MAZDA

MZ6

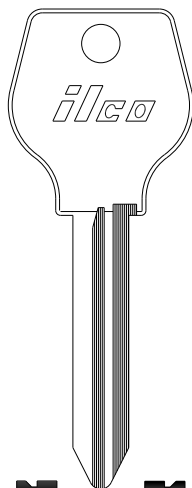
-

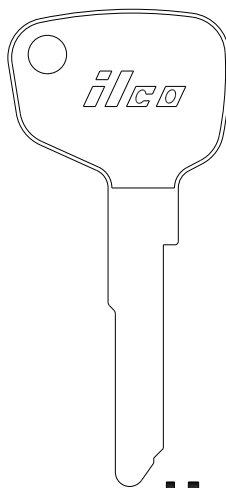

MZ7 MZ8

-

-

MZ15

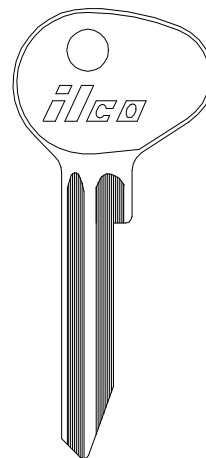
-

DA20

-

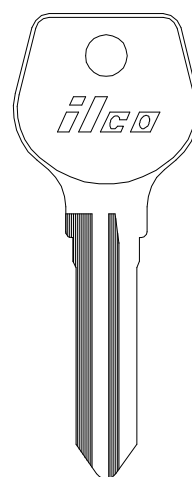

X26

MZ9

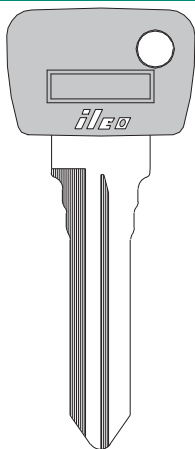

X27

MZ10

ILCO
EZ

MAZDA

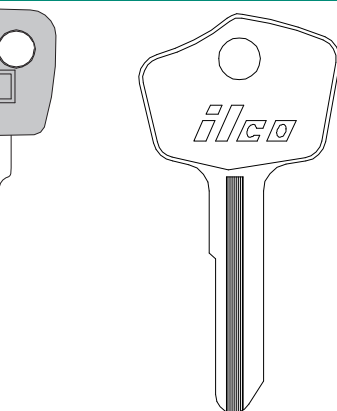
MZ9-P

-

MZ10-P

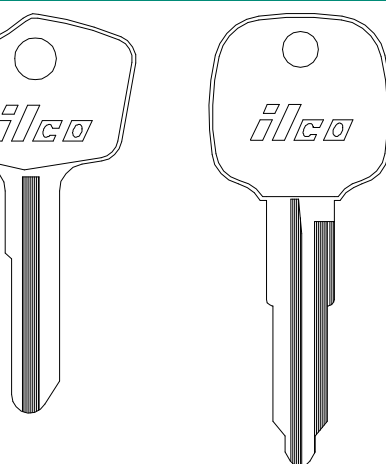
-

X36

MZ11

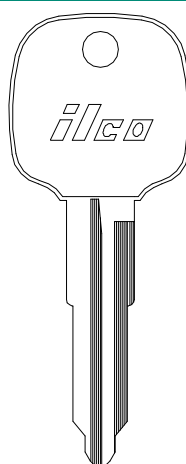
X60

MZ14

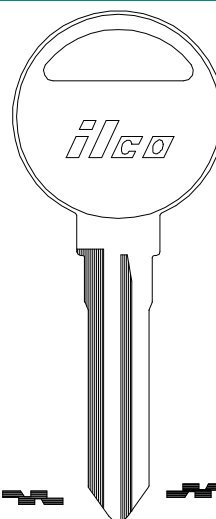
X131

MZ13

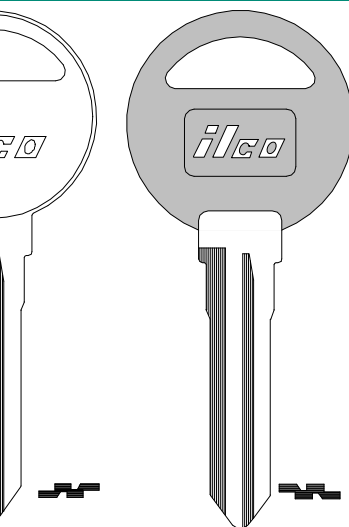

MZ13R

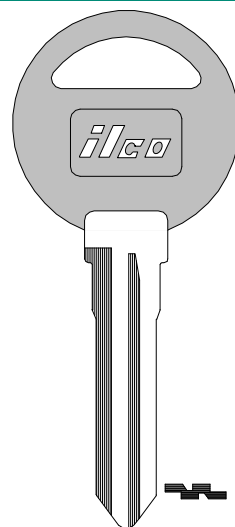
-

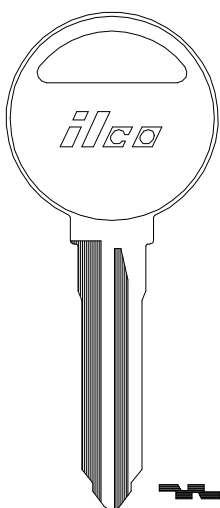

MZ13-P (-PC)

-

ILCO
EZ

MAZDA

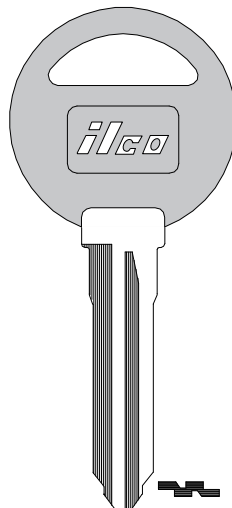
X178

MZ16

MZ16-P

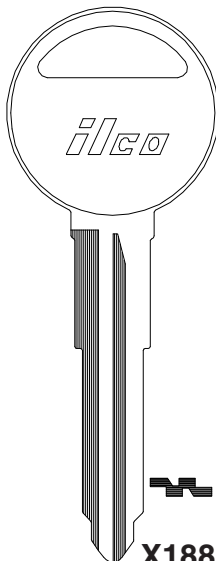
-

X188

MZ17

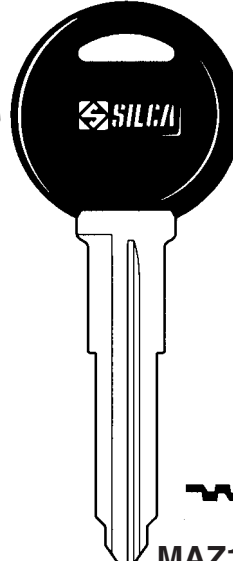
MAZ13AP

-

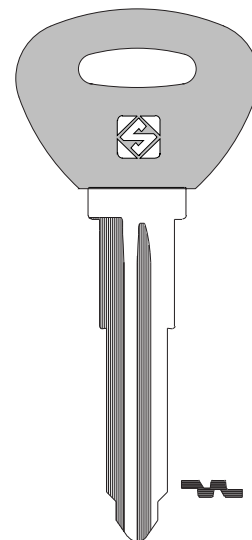
MAZ13EP

-

ILCO
EZ

MAZDA

MAZDA

VEHICLE

sec 1 page 94

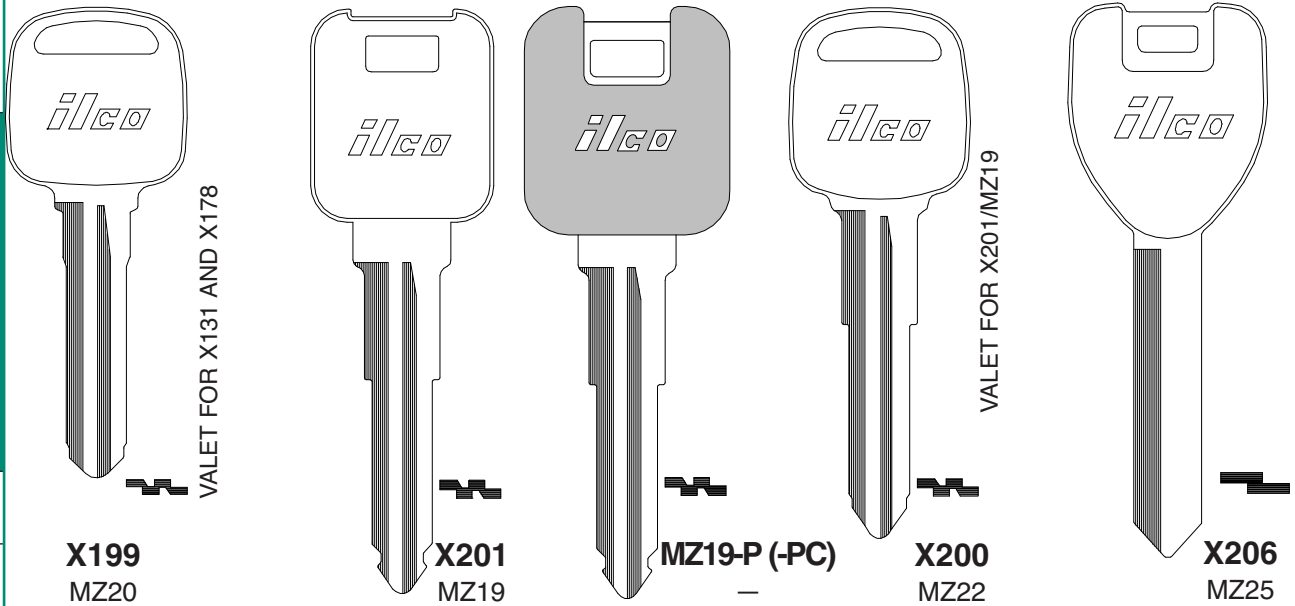

X199
MZ20

VALET FOR X131 AND X178

X201
MZ19

MZ19-P (-PC)
—

X200
MZ22

VALET FOR X201/MZ19

X206
MZ25

ILCO
EZ

MAZDA

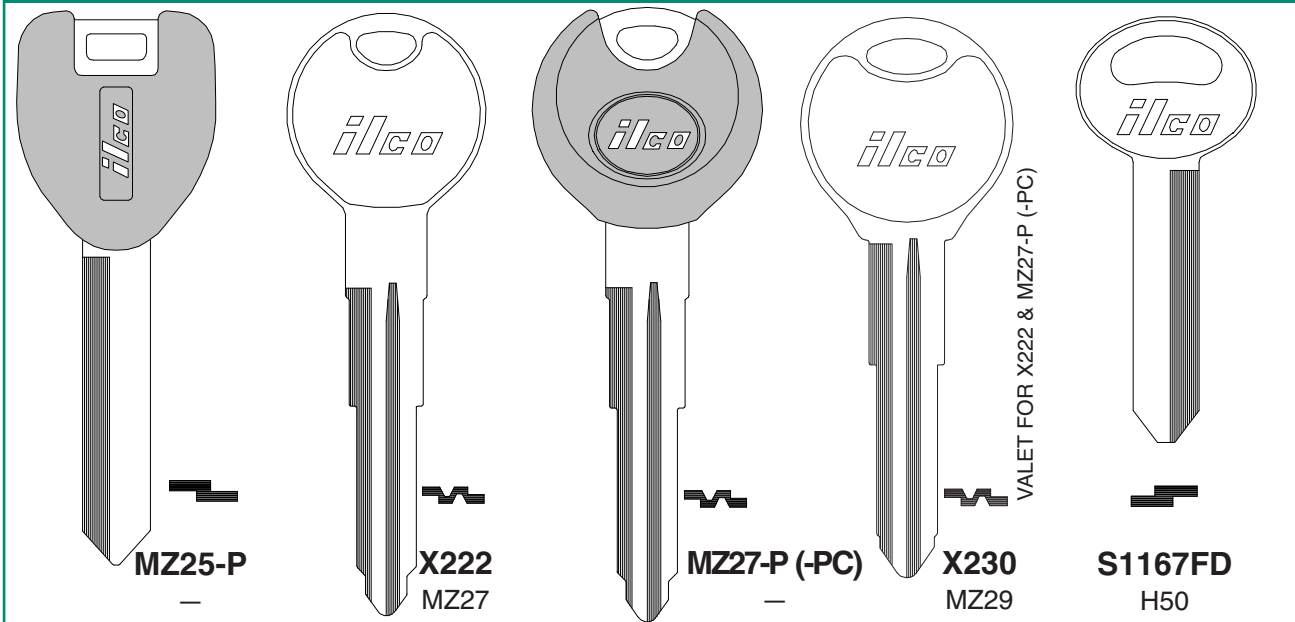

MZ25-P
—

X222
MZ27

MZ27-P (-PC)
—

X230
MZ29

VALET FOR X222 & MZ27-P (-PC)

S1167FD
H50

ILCO
EZ

MAZDA

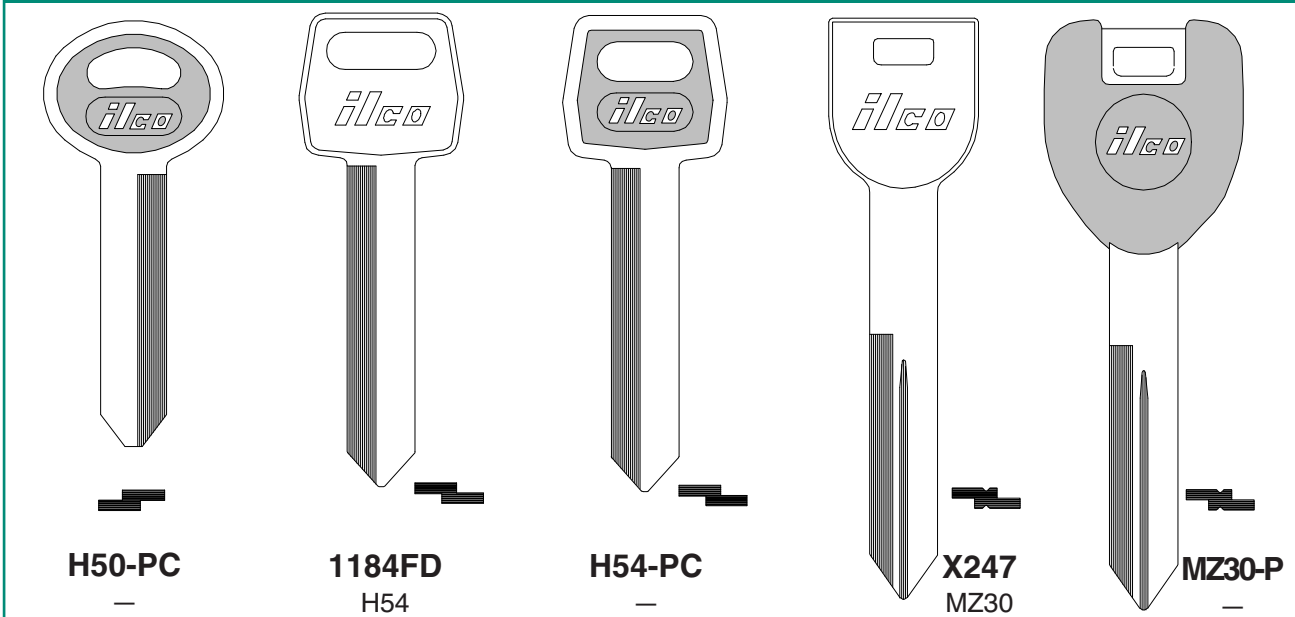

H50-PC
—

1184FD
H54

H54-PC
—

X247
MZ30

MZ30-P
—

ILCO
EZ

MAZDA

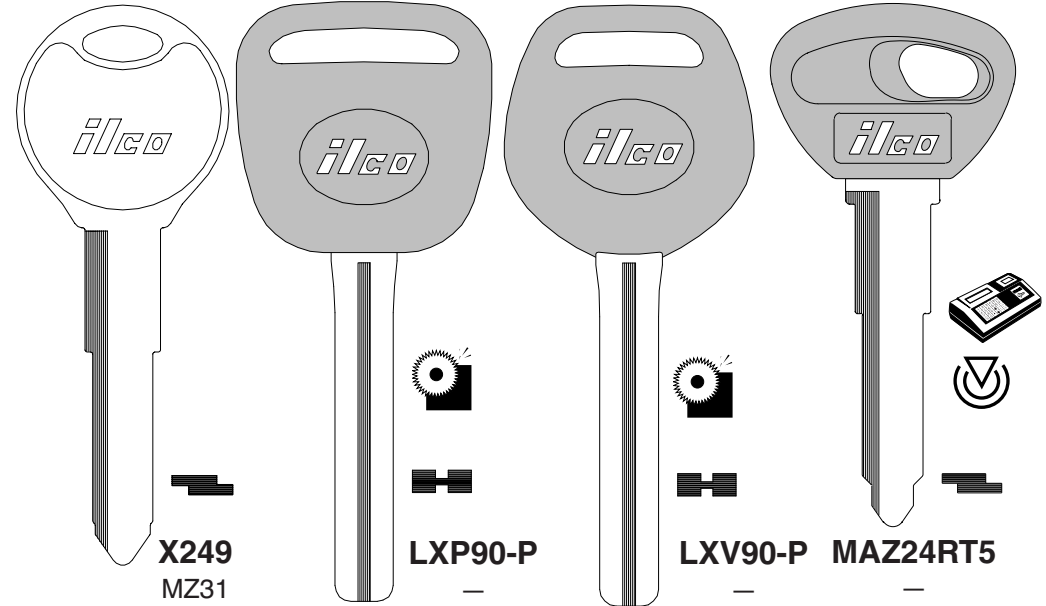

ILCO
EZ

X249
MZ31

LXP90-P
—

LXV90-P
—

MAZ24RT5
—

VEHICLE

sec 1 page 95

MAZDA

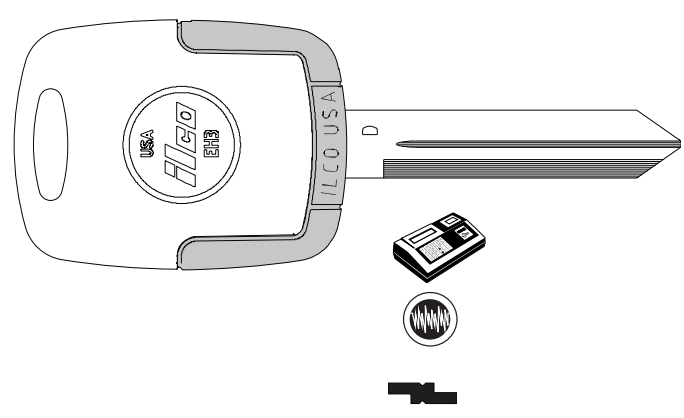

EH3
(Head Only)

EB3-D-H84
(Blade Only)

H84-EK3
(Complete Key)

ILCO
EZ

MAZDA

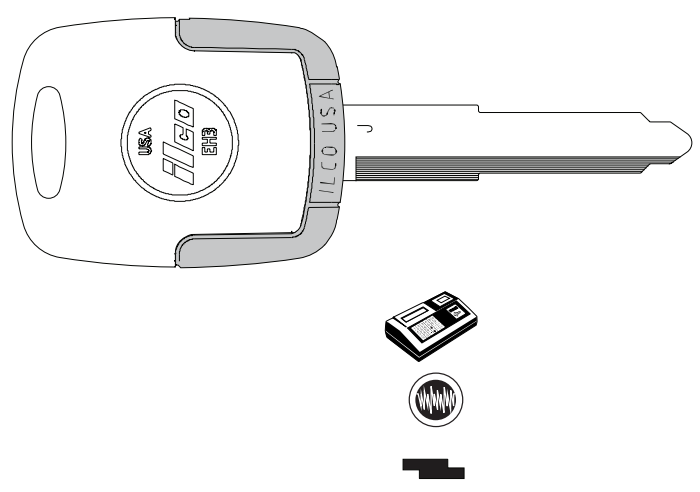

EH3
(Head Only)

EB3-J-MAZ24
(Blade Only)

MAZ24-EK3
(Complete Key)

ILCO
EZ

MAZDA - MERCEDES BENZ

VEHICLE

MAZDA

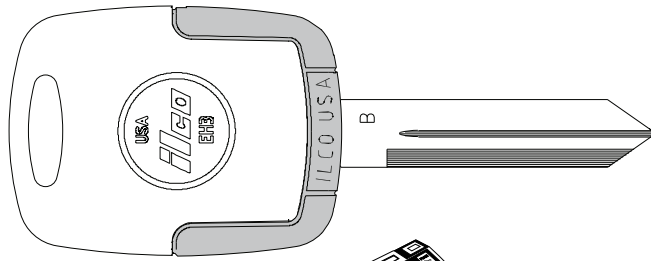

EH3
(Head Only)

EB3-B-H72
(Blade Only)

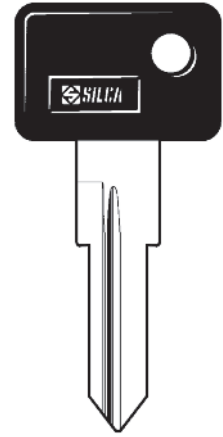

H72-EK3
(Complete Key)

ZD16RP-SI
—

ILCO
EZ

MAZDA

MERCEDES BENZ

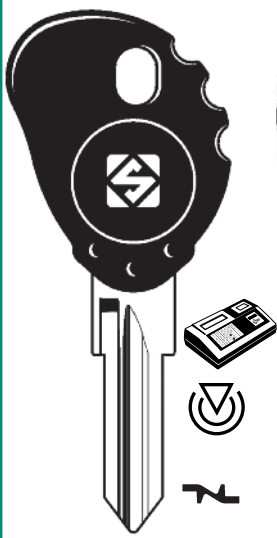

ZD23RT5-SI
—



ZD24RDP-SI
—

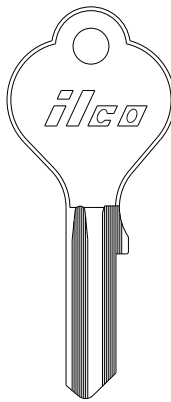

HF1
—

- HF3**
-
- HF4**
-
- HF5**
-
- HF6**

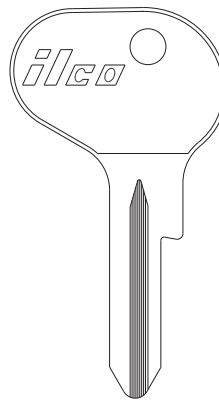

KL1
—

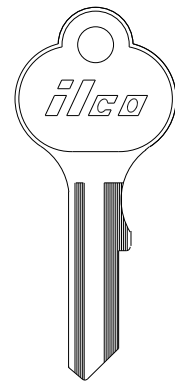

VW1
—

ILCO
EZ

MERCEDES BENZ

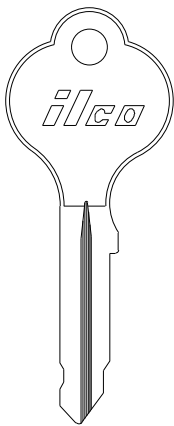

YM1
—

- YM3**
-
- YM4**
-
- YM5**
-

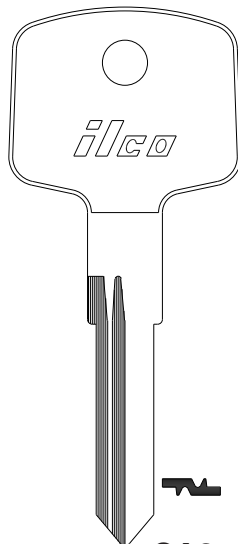

CA3
—

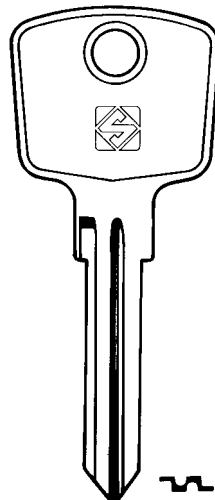



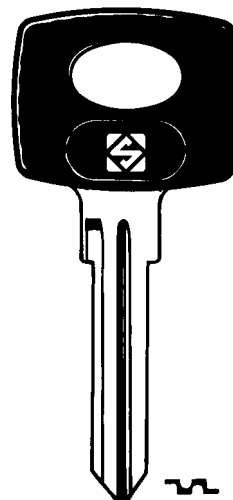







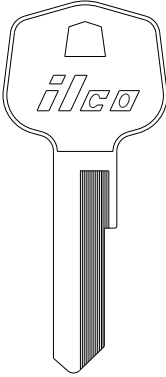

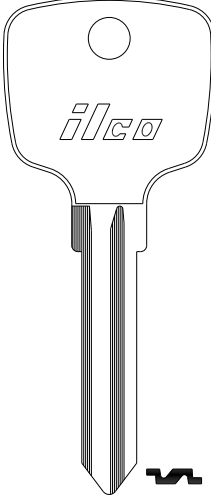

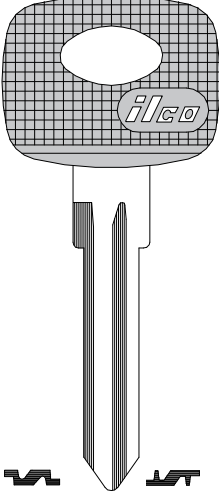
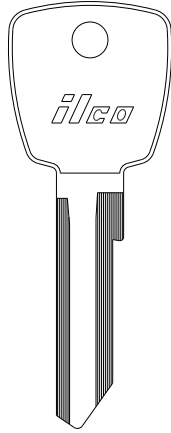
CR4R
—









CR4RP
—

ILCO
EZ

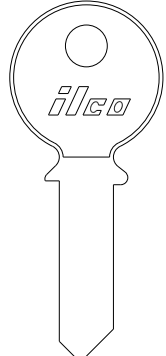
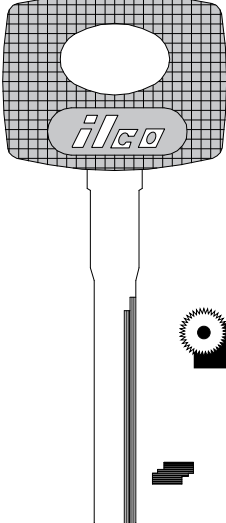
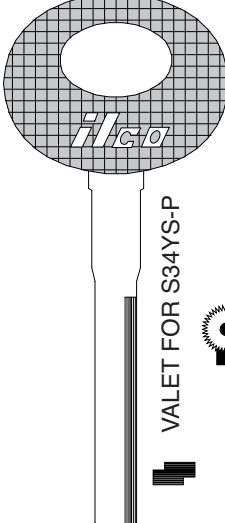
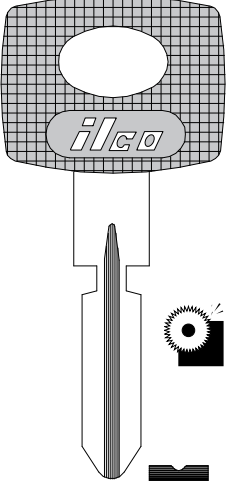
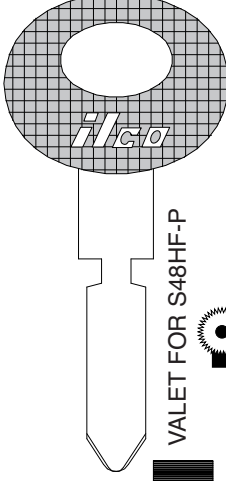
MERCEDES BENZ

ILCO EZ							
	HF9	HF14		MB16			
	—	—		—			
		HF15					MB17
							
	HF7	HF16	MB18	MB15	MB15-P	MB18-P	YM16
	—	—	—	—	—	—	—

MERCEDES BENZ







ILCO EZ					
					
	MB20	S34YS-P	S58HF-P	S48HF-P	S49HF-P
	—	—	—	—	—

VALET FOR S34YS-P

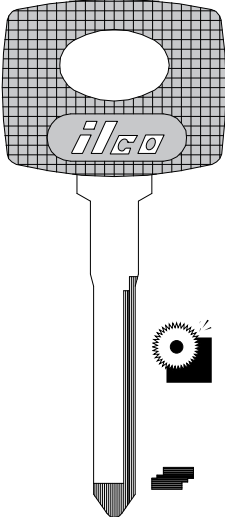
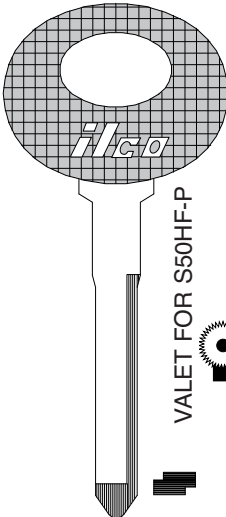
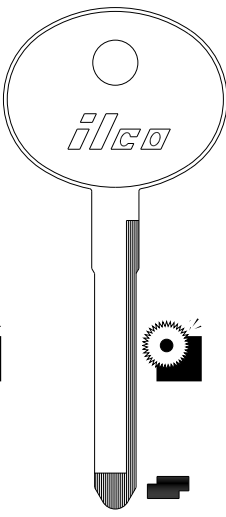
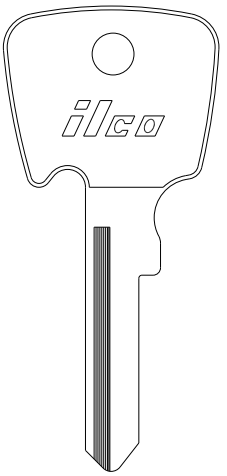
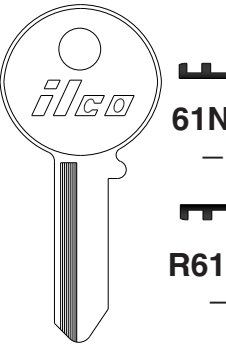
VALET FOR S48HF-P

VALET FOR S49HF-P

MERCEDES BENZ

ILCO EZ					
					
	S50HF-P	S53HF-P	HF57	MB59	61N
	—	—	—	M68	—

VALET FOR S50HF-P

VALET FOR S53HF-P

61NA

R61NA

MERCEDES BENZ

VEHICLE



61NC	H61NA	HR61NA	H61VM	H61VR	62VA	62VJ
-	-	-	-	-	-	-

ILCO
EZ

MERCEDES BENZ

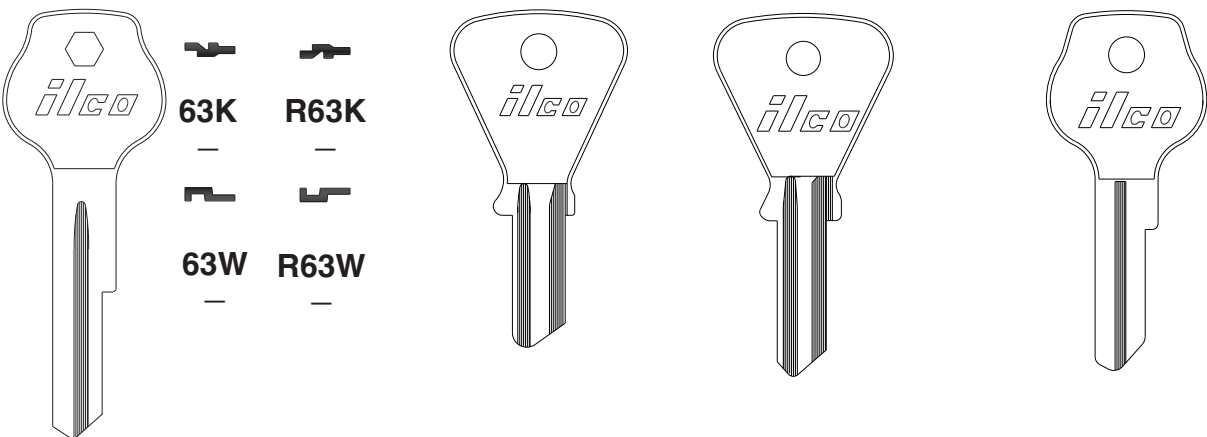

63K	R63K					
-	-					
63W	R63W					
-	-					
A62VN	B62G	H62VG	HR62VG	R62VA	R62VN	
-	-	-	-	-	-	

ILCO
EZ

MERCEDES BENZ

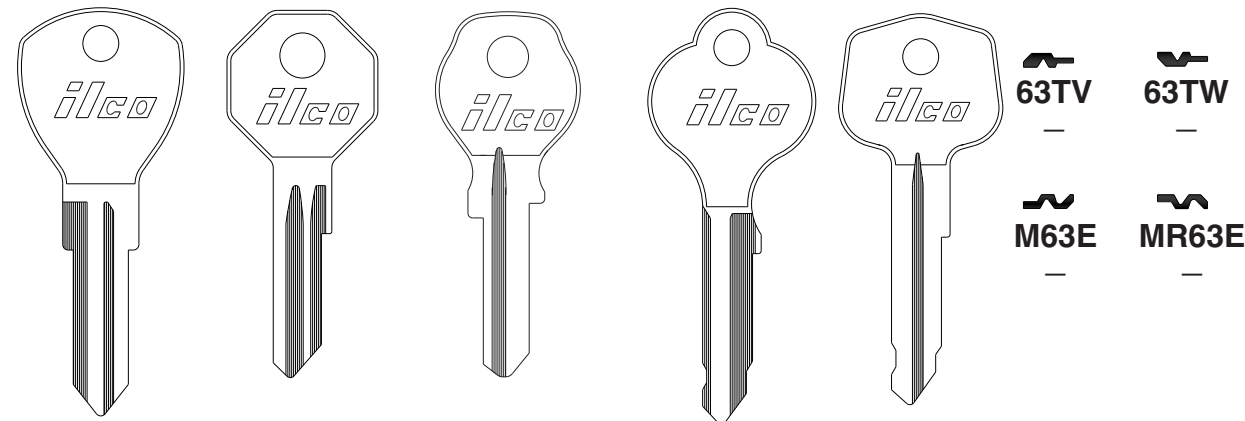

					63TV	63TW
					-	-
S62FD	63A	M63BG	63C	63E	M63E	MR63E
-	-	-	-	-	-	-

ILCO
EZ

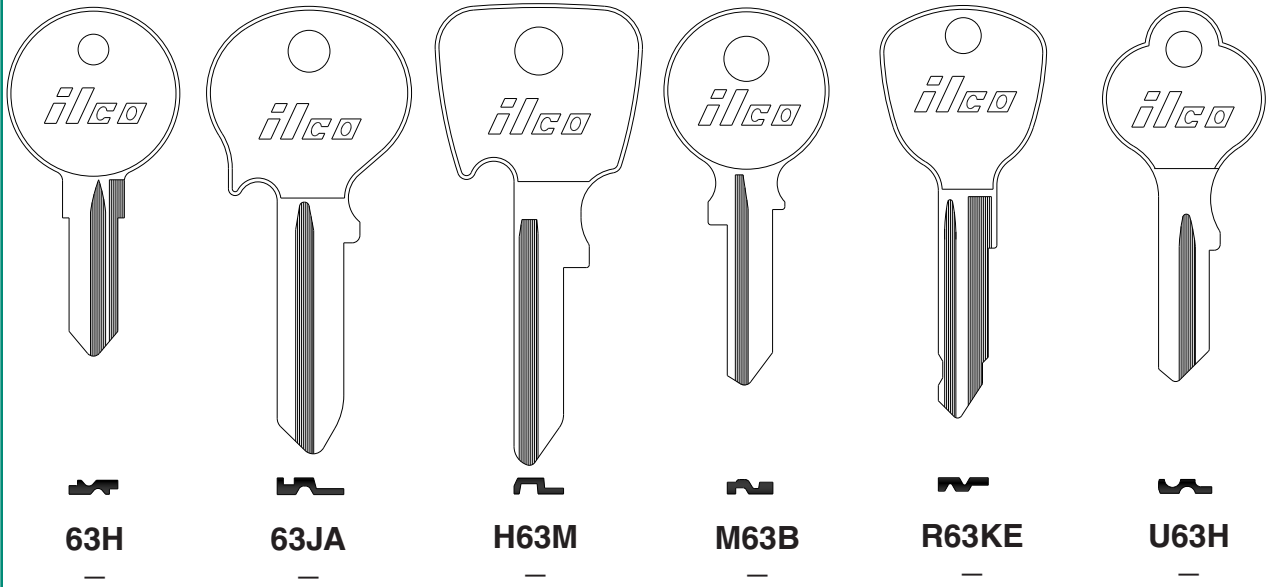
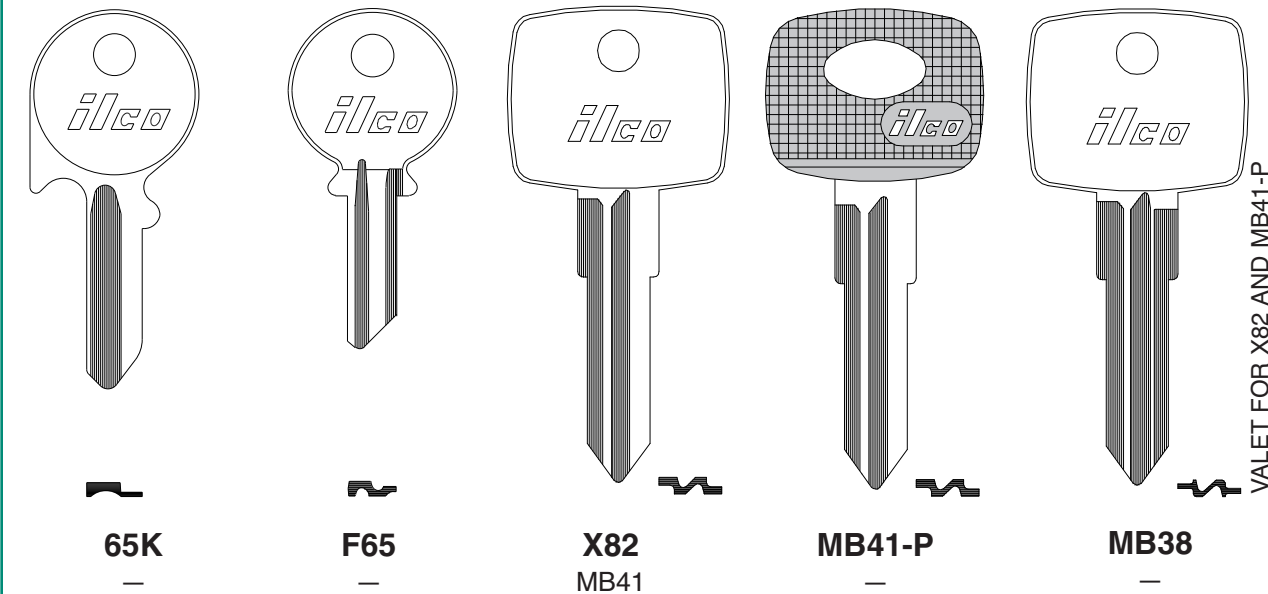
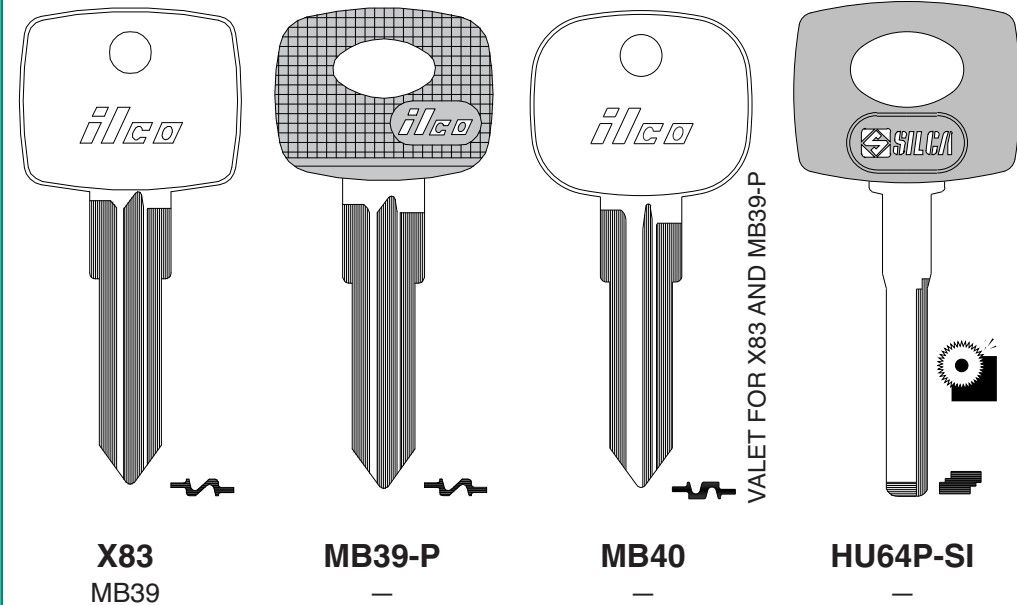
MERCEDES BENZ**MERCEDES BENZ****MERCEDES BENZ****MERCURY****SEE FORD**

MERCURY/MARINER OUTBOARDS

							ILCO EZ
1040	1040A	1040B	1040C	R1040C	1040E	R1040E	

MERCURY/MARINER OUTBOARDS

MERKUR

MESSERSCHMIDT

				SEE FORD INTERNATIONAL		ILCO EZ
CU9	CU10	1040U	CU12		62VA	
CU7	CU8	1262A	1193MU H66			

MESSERSCHMIDT MG

MISC. SWITCHES

	SEE BRITISH LEYLAND				ILCO EZ
63A		1098M B1	L1003M	1043B IL9	

MISC. SWITCHES

MITSUBISHI

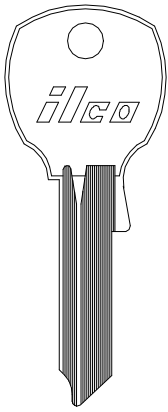

1069LB
NA12

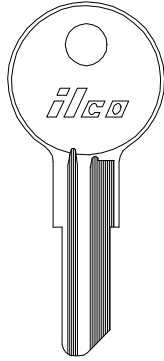

O1122
Y11

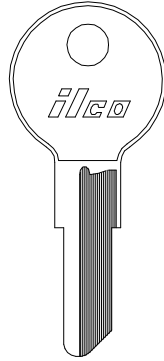

O1122AR
Y14

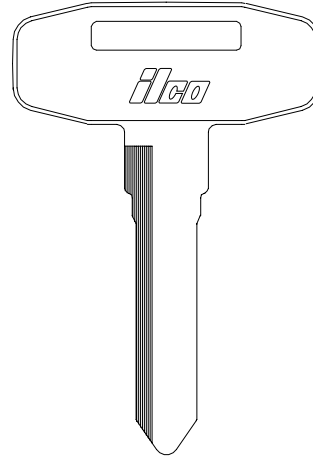

FU2
—

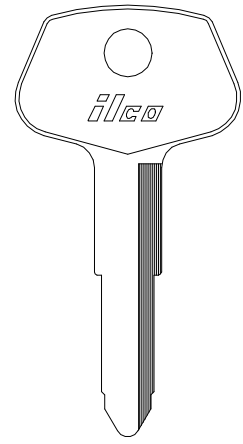

X54
DC1

ILCO
EZ

MITSUBISHI

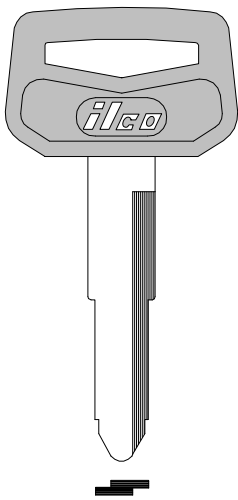

DC1-P
—

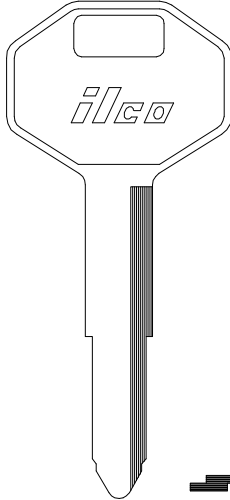

X121
DC3

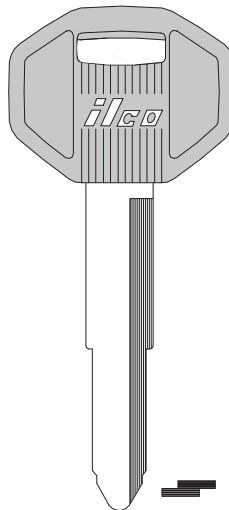

DC3-P (-PC)
—

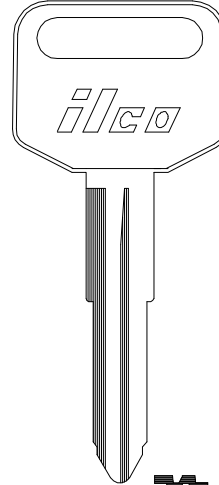

X160
HY2

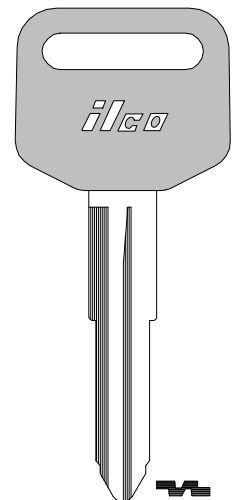

HY2-P
—

ILCO
EZ

MITSUBISHI

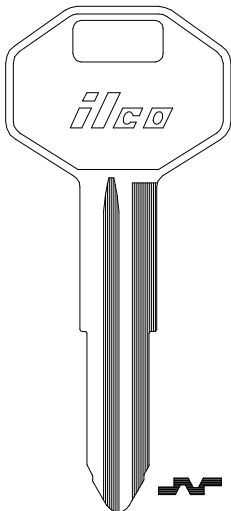

X176
MIT1

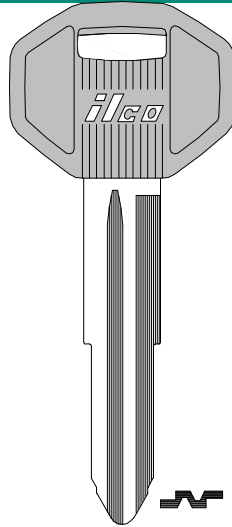

MIT1-P (-PC)
—

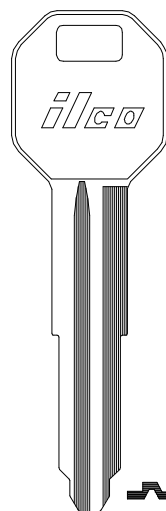

X213
MIT2

VALET FOR X176 & MIT1-P (-PC)

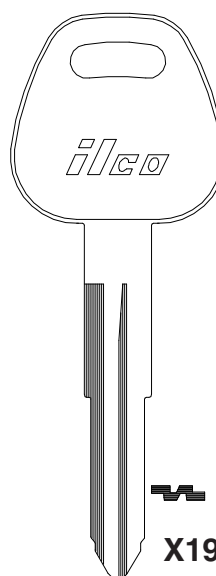

X196
HY5

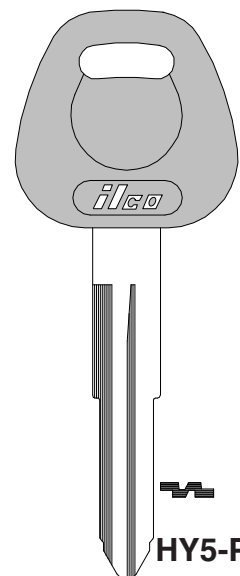

HY5-P
—

ILCO
EZ

MITSUBISHI

VEHICLE

sec 1 page 102

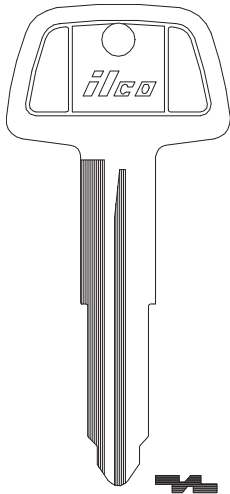

X224
MIT3

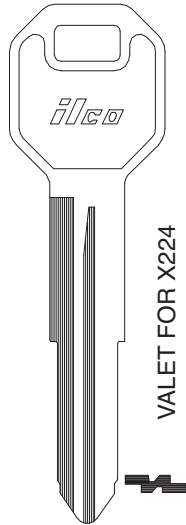

X229
MIT5

VALET FOR X224

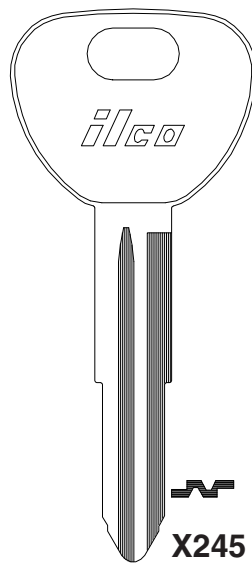

X245
MIT4

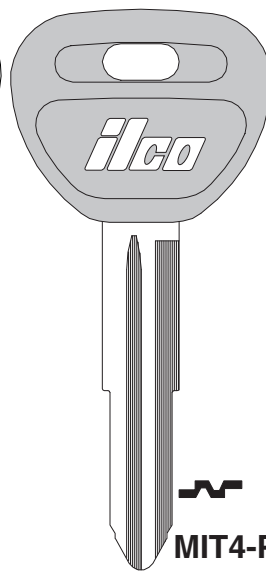

MIT4-P
—

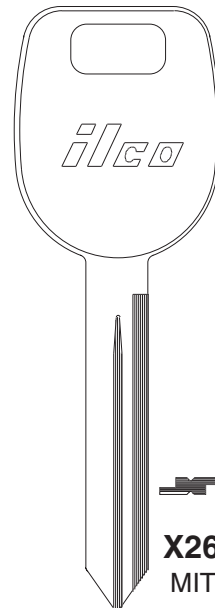

X263
MIT6

ILCO
EZ

MITSUBISHI

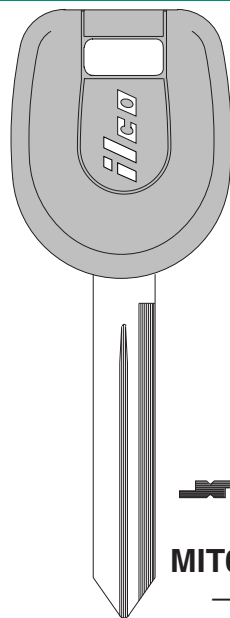

MIT6-P
—

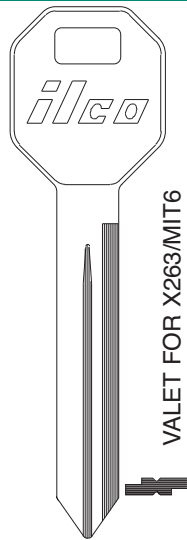

X264
MIT7

VALET FOR X263/MIT6

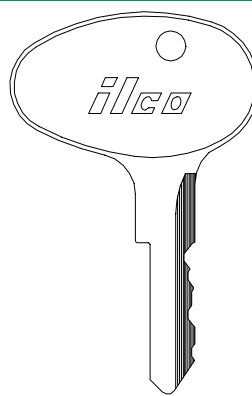

1596
—

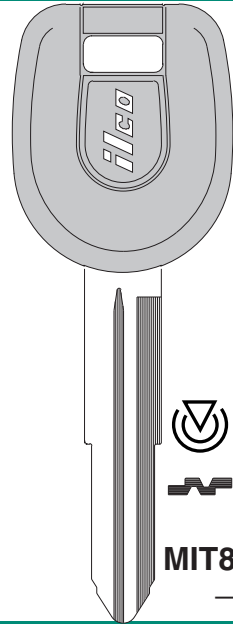

MIT8-PT
—

ILCO
EZ

MITSUBISHI

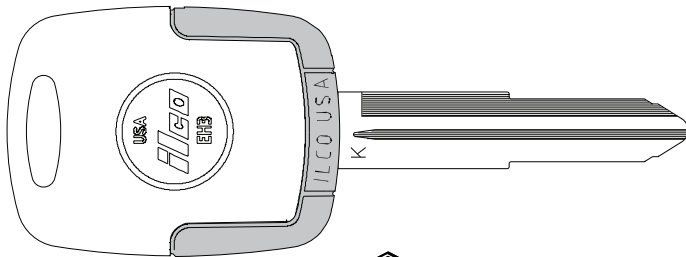

MIT8-EK3
(Complete Key)



EH3
(Head Only)



EB3-K-MIT8
(Blade Only)

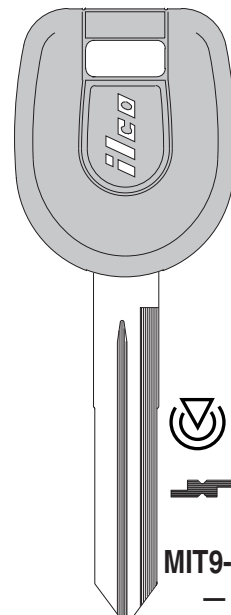

MIT9-PT
—

ILCO
EZ

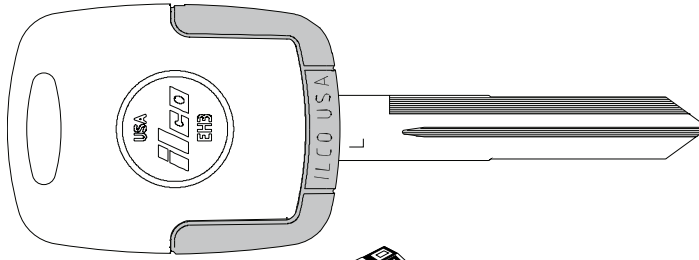
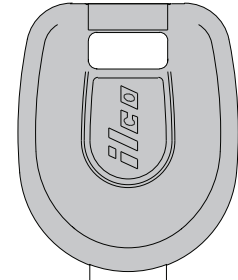
MITSUBISHI**MIT9-EK3**
(Complete Key)**EH3**
(Head Only)**EB3-L-MIT9**
(Blade Only)**MIT12-PT**
—ILCO
EZ

VEHICLE

sec 1 page 103

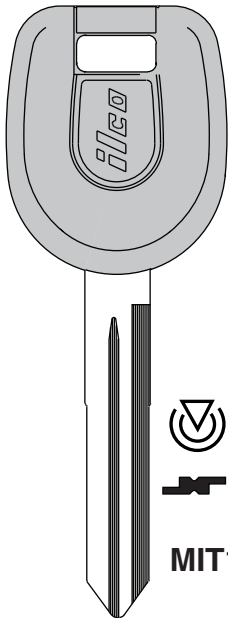
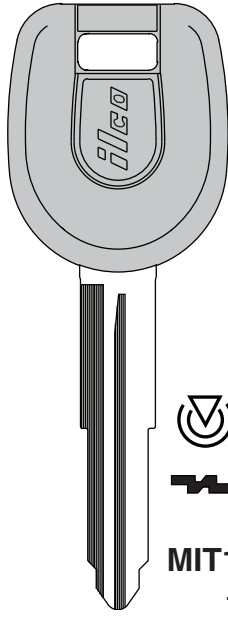
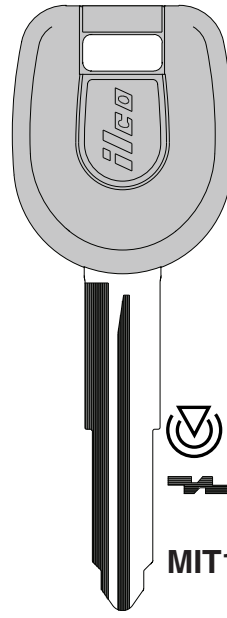
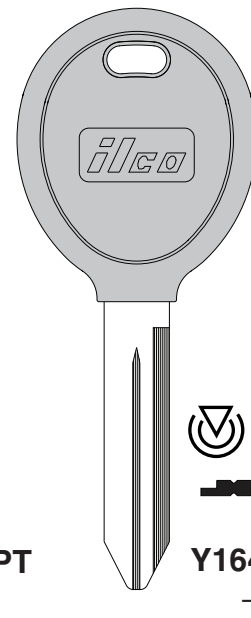
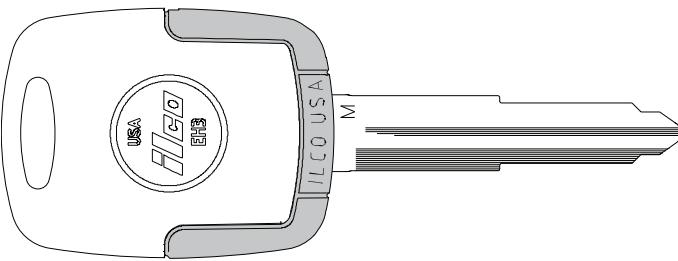
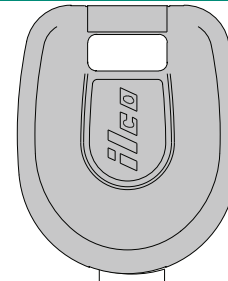
MITSUBISHI**MIT13-PT**
—**MIT14-PT**
—**MIT17A-PT**
—**Y164-PT**
—ILCO
EZ**MITSUBISHI****MIT14-EK3**
(Complete Key)**EH3**
(Head Only)**EB3-M-MIT14**
(Blade Only)**MIT16A-PT**
—ILCO
EZ

MITSUBISHI

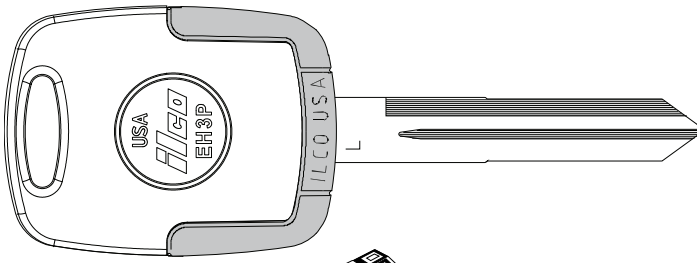

EH3P
(Head Only)



EB3-L-MIT9
(Blade Only)



EK3P-MIT16
(Complete Key)

ILCO
EZ

MITSUBISHI

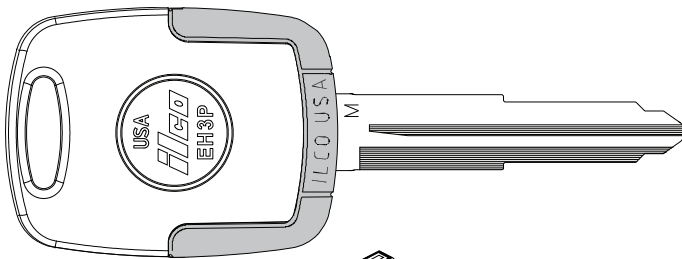

EH3P
(Head Only)



EB3-M-MIT14
(Blade Only)



EK3P-MIT17
(Complete Key)

ILCO
EZ

MITSUBISHI

MITSUBISHI-CATERPILLAR

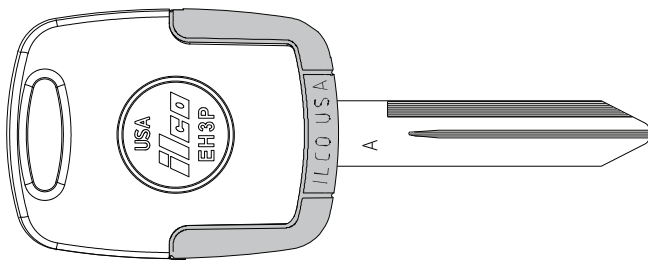

EH3P
(Head Only)

EB3-A-Y160
(Blade Only)



EK3P-Y164
(Complete Key)

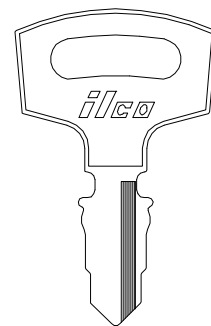

1583
—

ILCO
EZ

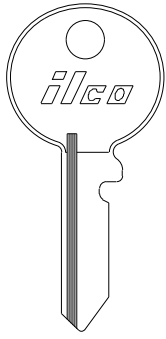
MOB
MOPED

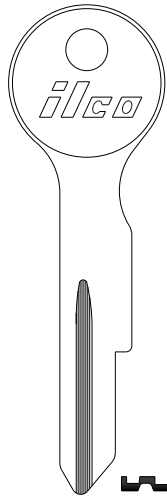
62DP

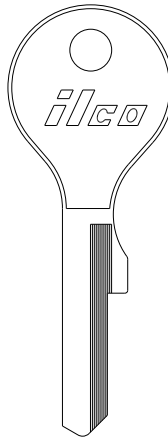
Z1

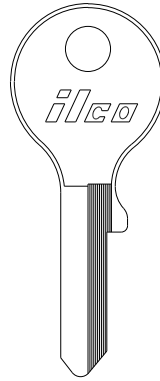
Z3H

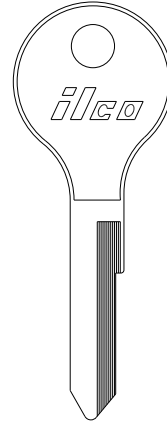
SR61N

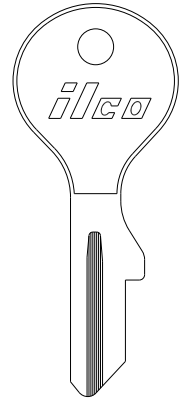
Y61

Z91
ILCO
EZ

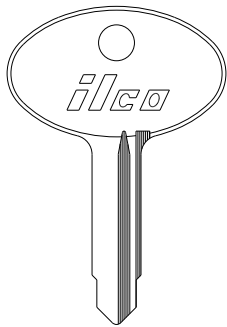
MORETTI

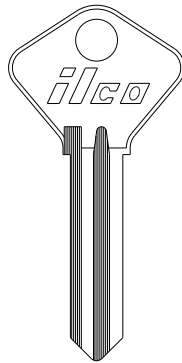
61D

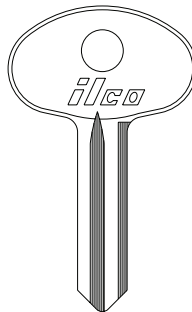
R61G

65FA

65G

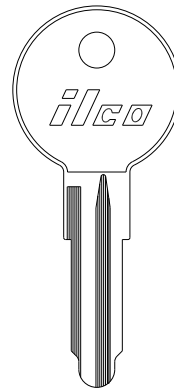
R65G

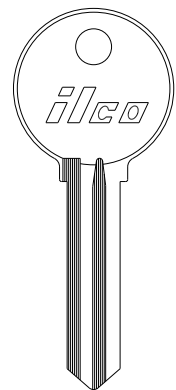
66A

66BB
ILCO
EZ

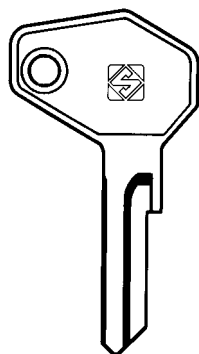
MORGAN
MOTO GUZZI
**SEE
BRITISH
LEYLAND**

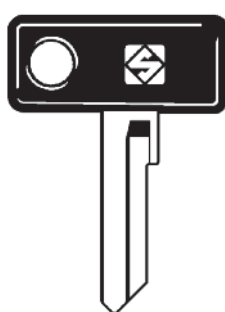
ZD7-SI

ZD9P-SI

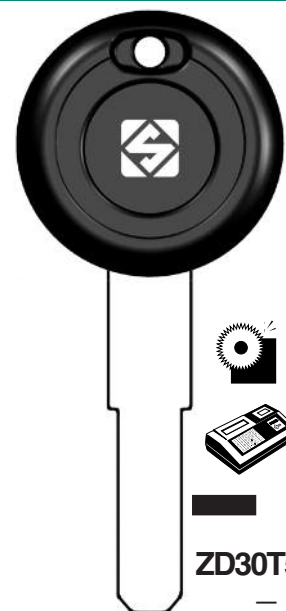

ZD24RDP-SI

ZD30T5-SI
ILCO
EZ

MOTO GUZZI		MV	MZ	N.S.U.	
X234 HYD13	X270 TMC1	X259 —	X270 TMC1	NE1 —	ILCO EZ

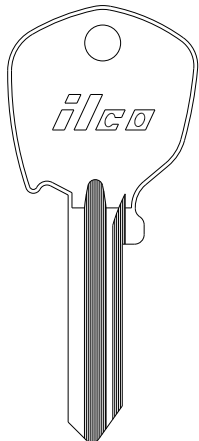
N.S.U.					
HF18 —	HF26 —	HF29 —	HF37 —	63VO —	ILCO EZ

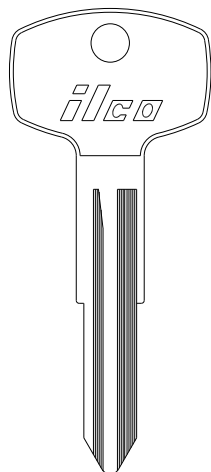
N.S.U.		NISSAN		
		5 PIN 	6 PIN 	
63Y —	5 PIN 	DT5 —	DT4 —	X1 MZ12
	6 PIN 			
		D72Z —	DT7 —	DT2 —
		D72D —	DT8 —	DT3 —
				ILCO EZ

NISSAN

FT6

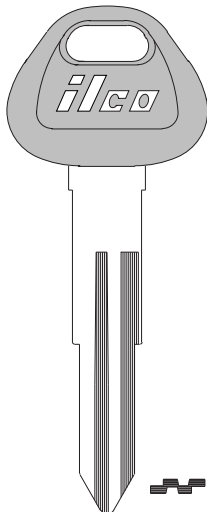
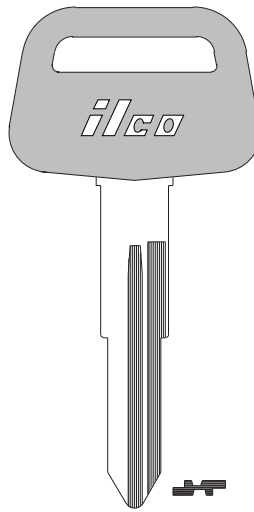
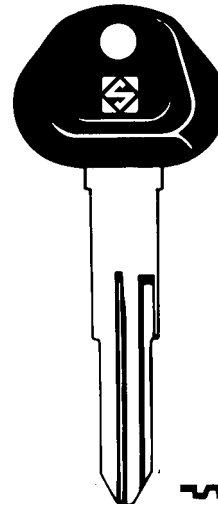
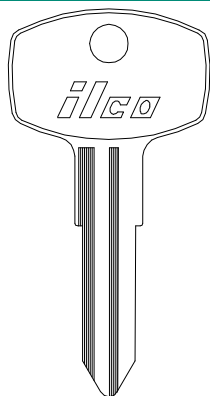
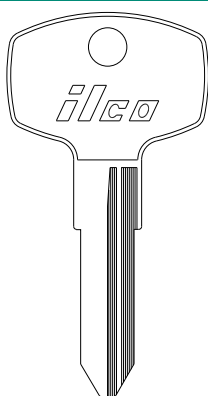
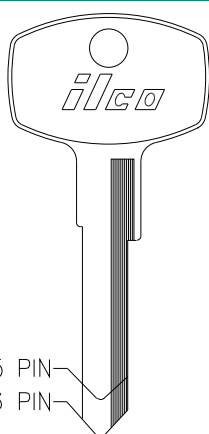
FT6R

X6

X7

DAT6P

DAT6BP

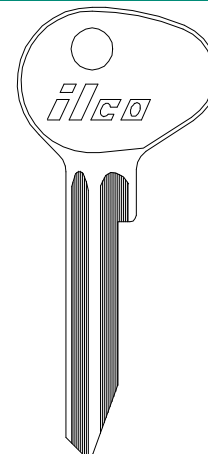
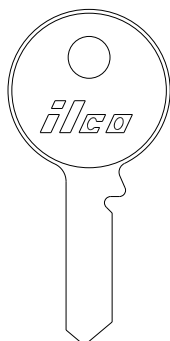
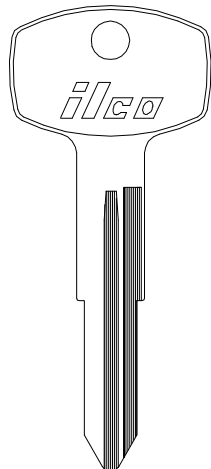
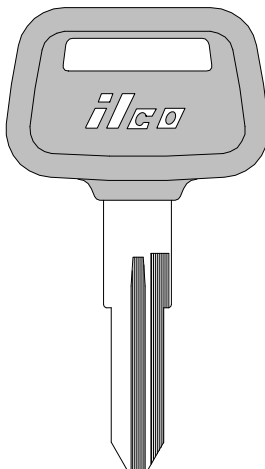
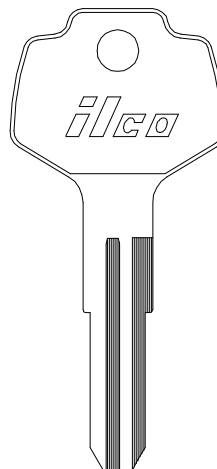
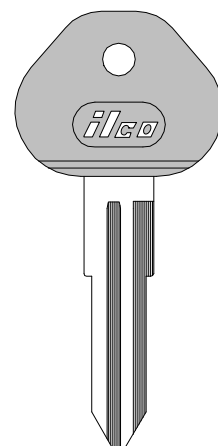
DAT6RP
**ILCO
EZ**
NISSAN

X10
62DV

DT20

 5 PIN
6 PIN

DT13 **DT9**

5 PIN

6 PIN

DT14
DT10
DT15
DT11
DT16
DT12

DA20
**ILCO
EZ**
NISSAN

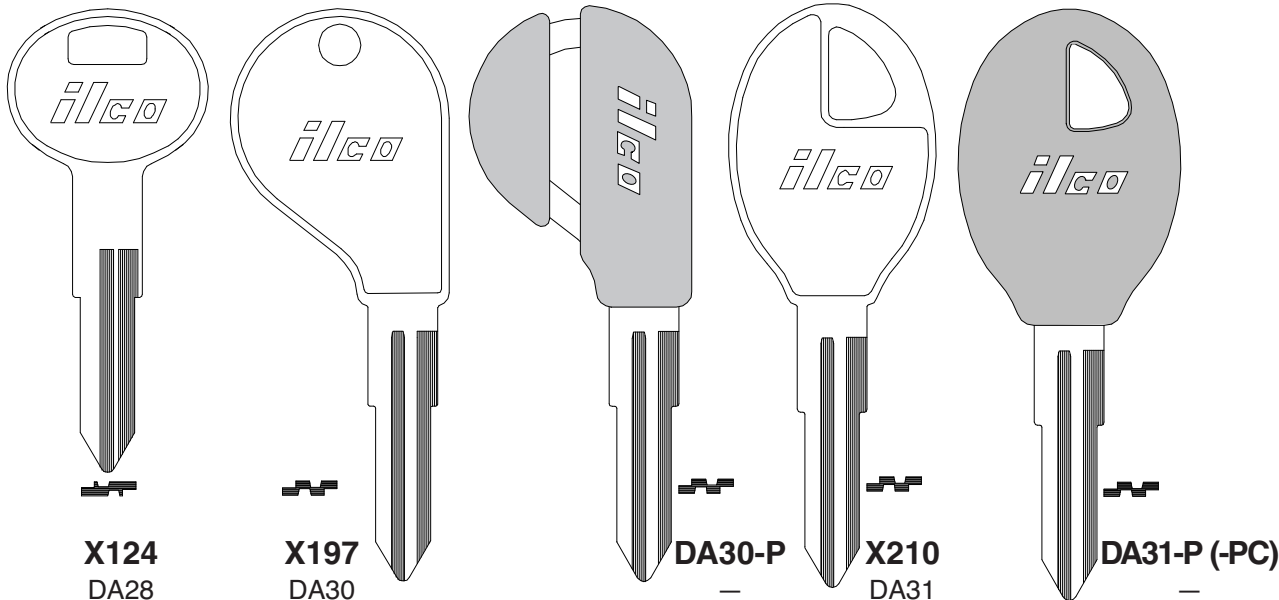
65TA

X115 **X114**
DA23 DA24

DA23-P

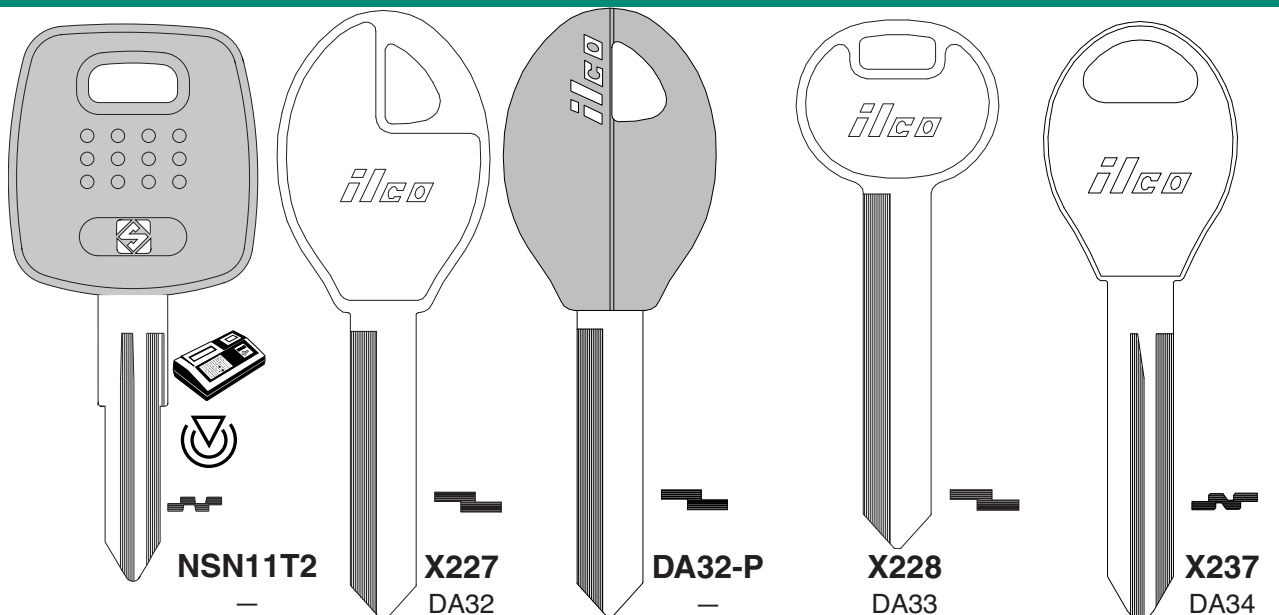
X123
DA25

DA25-P (-PC)
**ILCO
EZ**

NISSAN



ILCO
EZ

NISSAN



ILCO
EZ

NISSAN

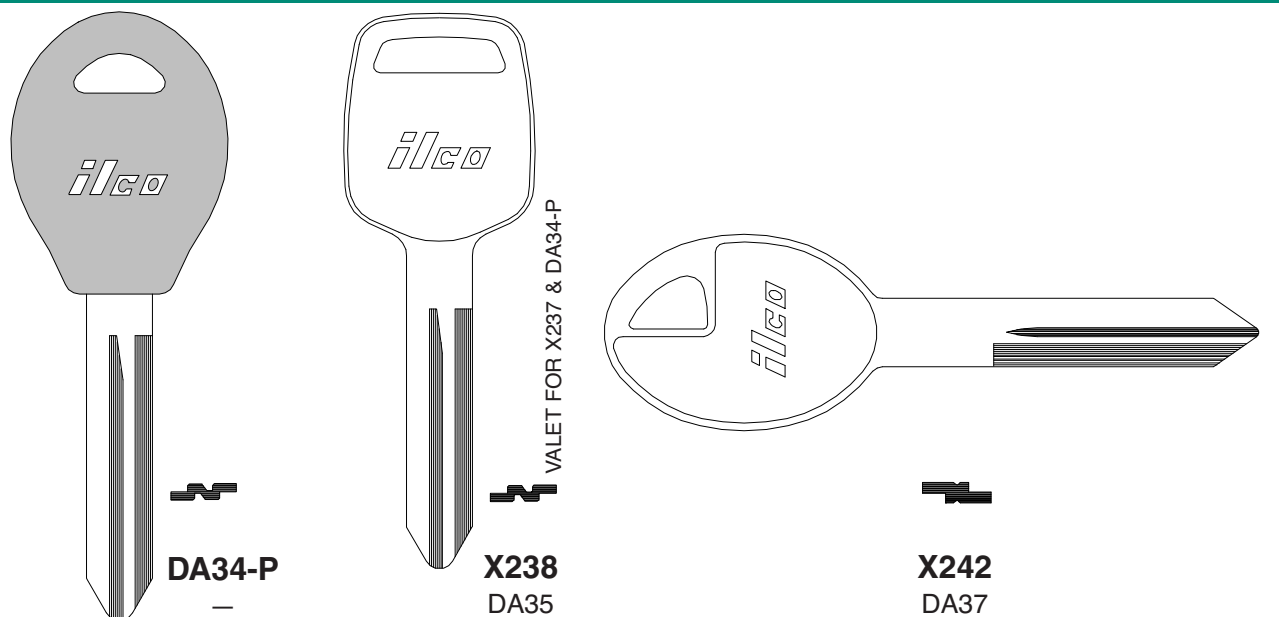

ILCO
EZ

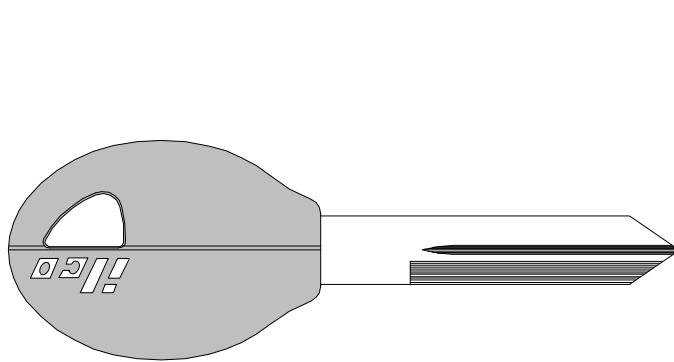
NISSAN**DA37-P**

—

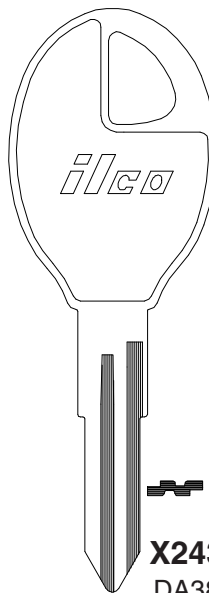
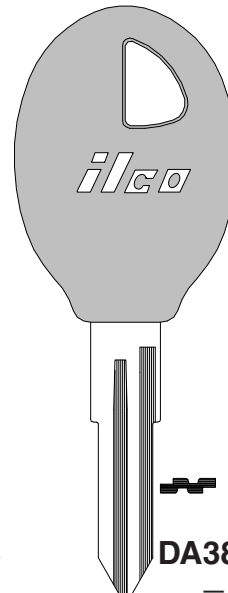
**X243**
DA38**DA38-P**

—

ILCO
EZ

sec 1 page 109

VEHICLE

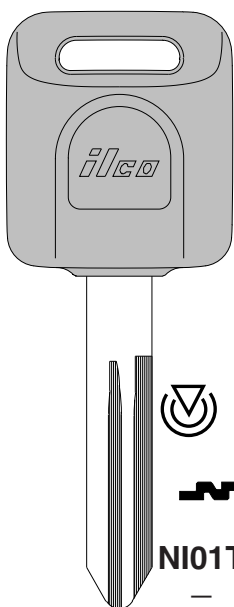
NISSAN**NI01T**

—

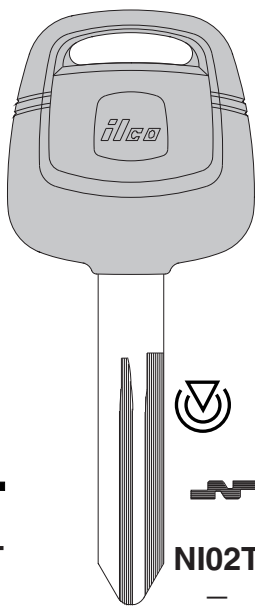
**NI02T**

—

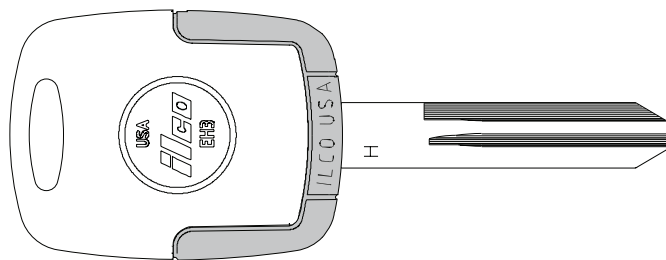
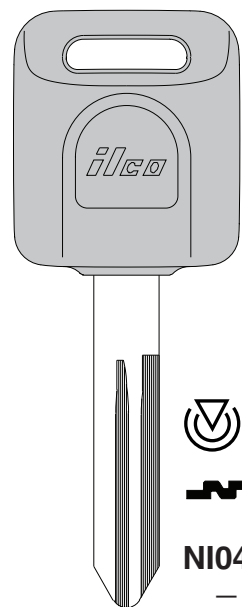
**NI02-EK3**
(Complete Key)**EH3**
(Head Only)**EB3-H-NI02**
(Blade Only)**ILCO**
EZ**NISSAN****NI04T**

—

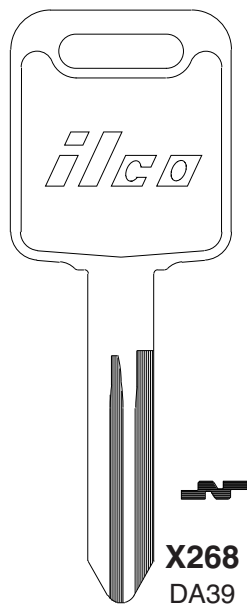
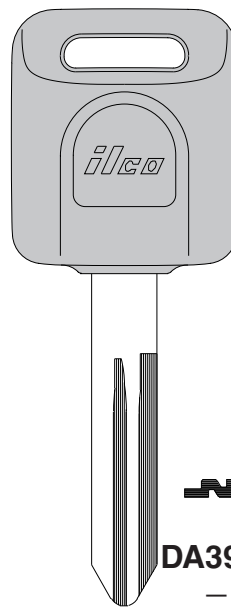
**X268**
DA39**DA39-P**

—

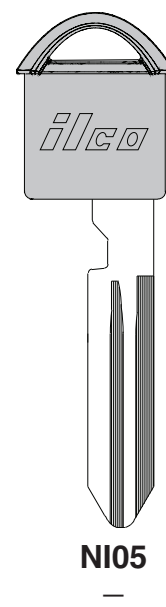
**NI05**

—

ILCO
EZ

NISSAN

NORTON

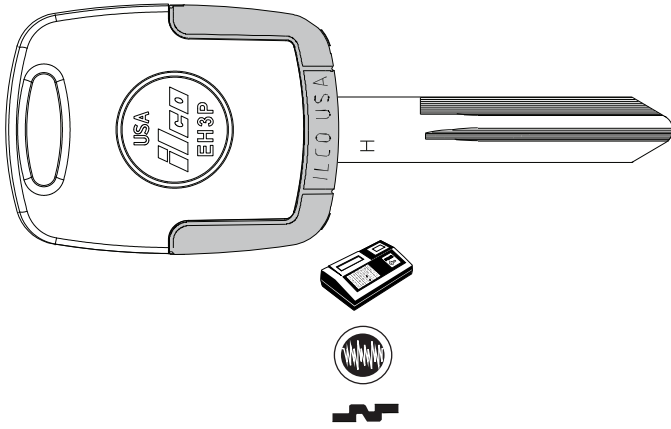

EH3P
(Head Only)

EB3-H-NI02
(Blade Only)

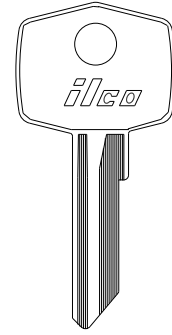

62FS
—

EK3P-NI04
(Complete Key)

ILCO
EZ

NORTON

OLDSMOBILE

OMC (JOHNSON & EVINRUDE)

OPEL

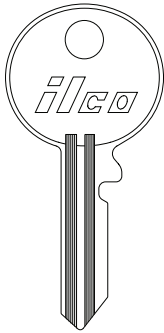



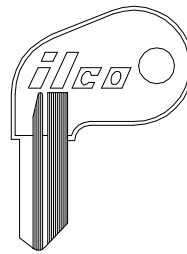

R62DM
—

**SEE
GENERAL
MOTORS
(GM)**

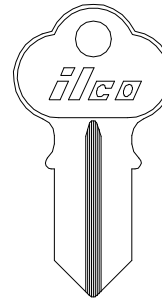

OM10
—



 
1041G 1041GA
CG1 CG2

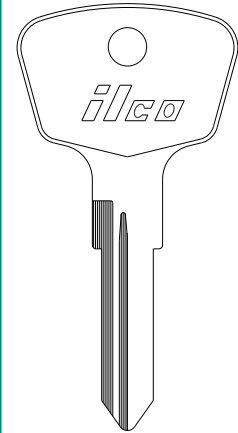



AD1
—

ILCO
EZ

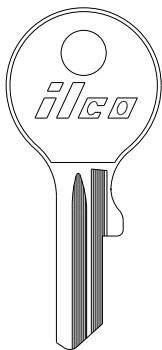
OPEL

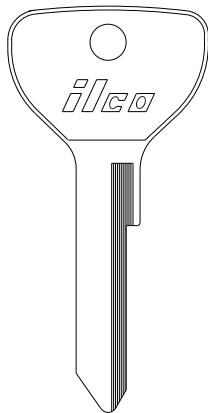

 
BU1 BU2
— —



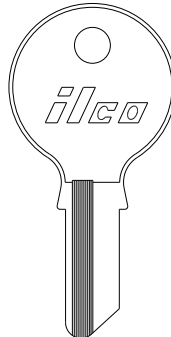

OPB1
—

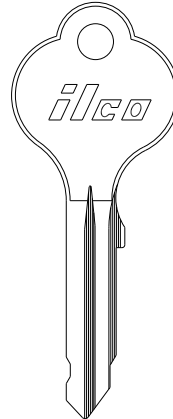

DK3
—

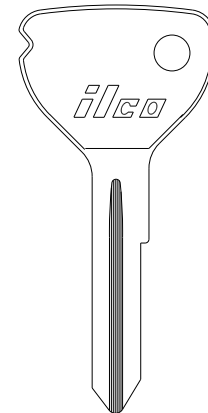

YM3
—





YM6
—

YM7
—

YM8
—

YM9
—

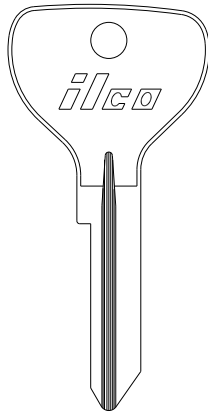
ILCO
EZ

OPEL

62PD
—

R62PD
—

U62VP
—

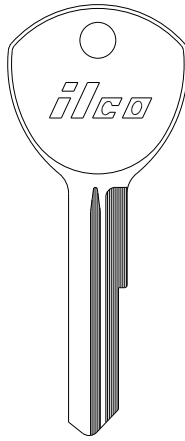
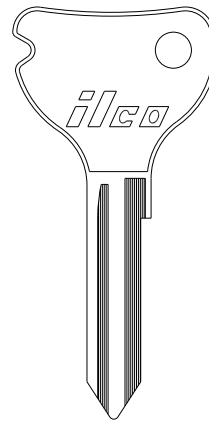
UR62VP
—

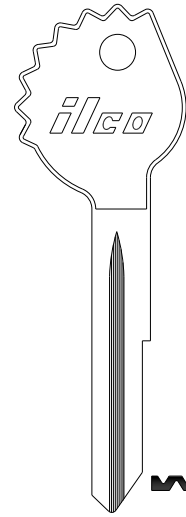
HF21
—

HF12
—

OP12
—

OP37
—

YM13
—

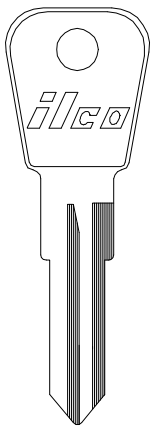
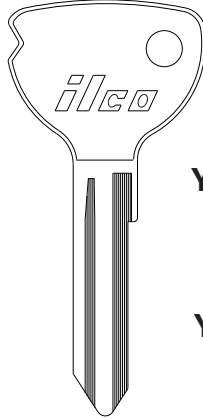
OP11
—

HF11
—

ILCO
EZ

OPEL

X21
YS1

X22
YS2

YM23
—

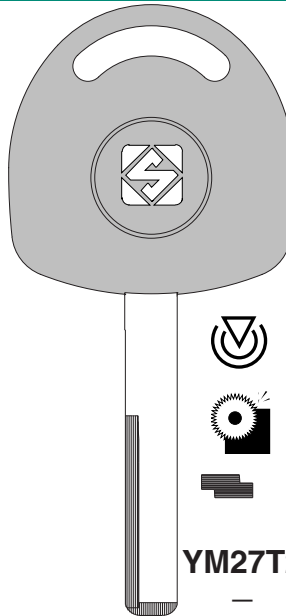
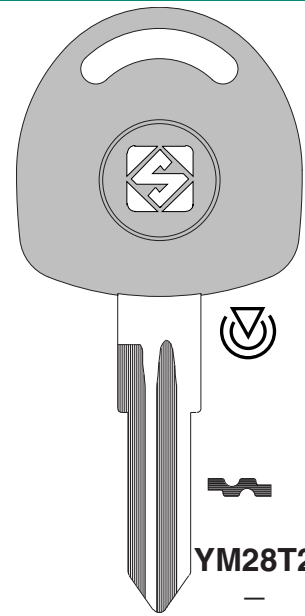
YM24
—

YM25
—

YM27
—

YM27T2
—

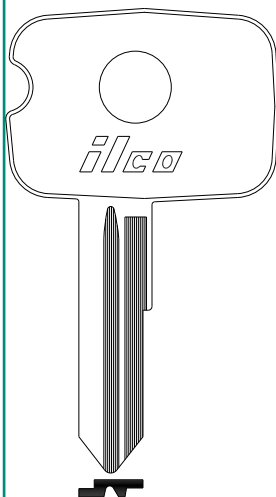
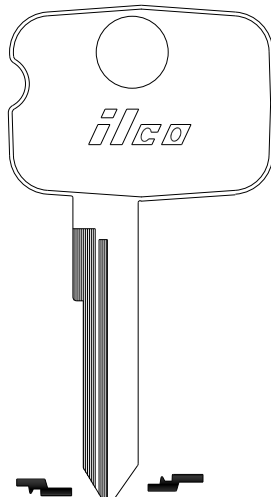
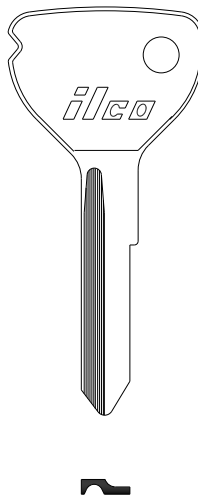
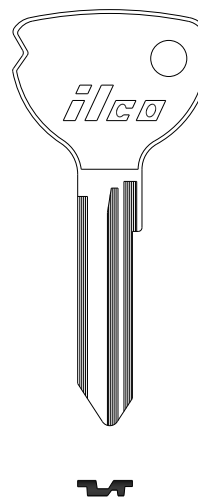
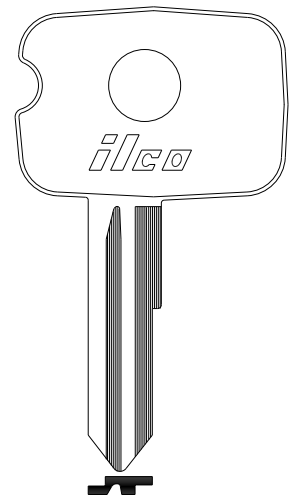
YM28T2
—

ILCO
EZ

OPEL

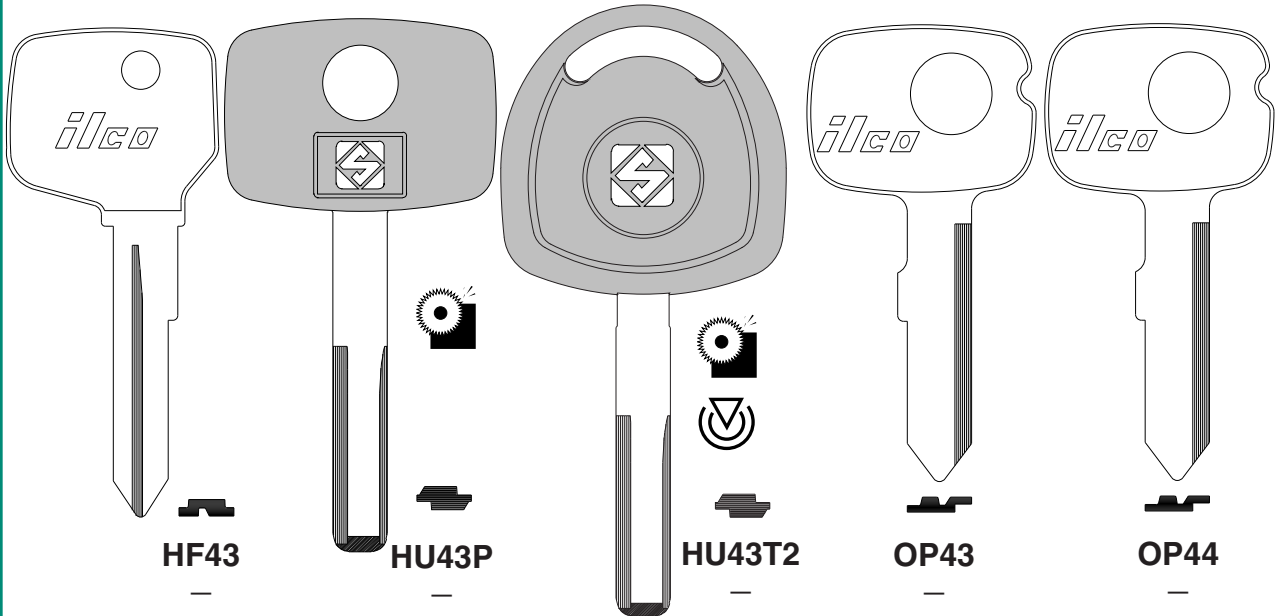
YM28
—

YM30 **YM29**
—

OP32
—

OP36
—

HF38
—

ILCO
EZ

OPEL



HF43

HU43P

HU43T2

OP43

OP44

ILCO
EZ

OPEL

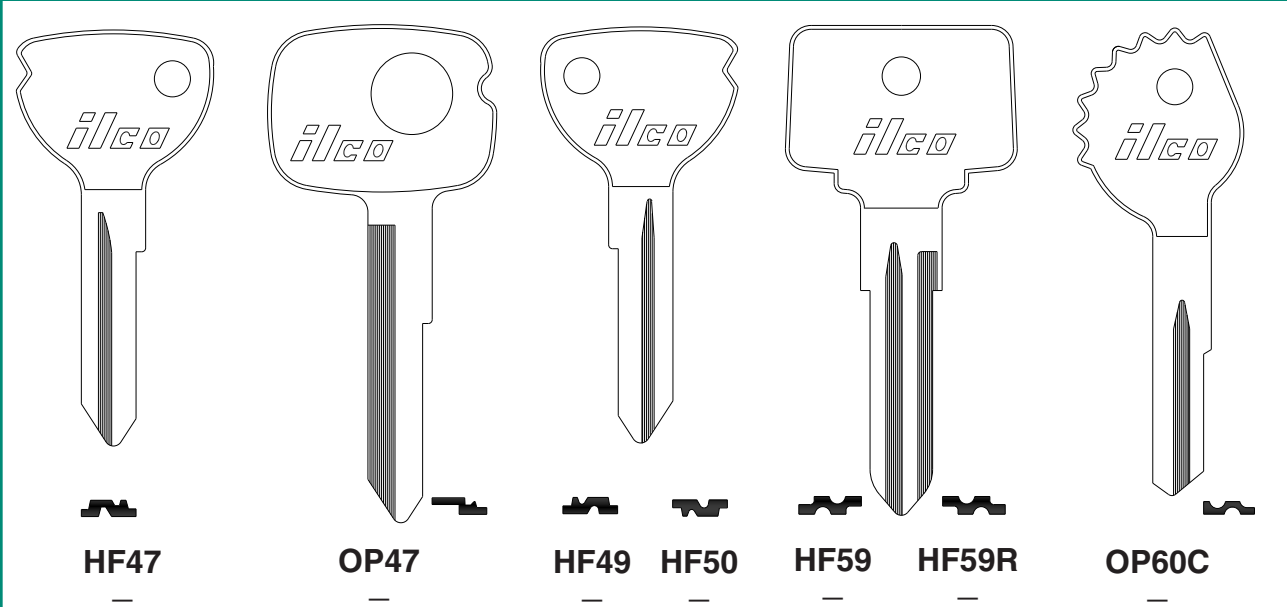

HF47

OP47

HF49

HF50

HF59

HF59R

OP60C

ILCO
EZ

OPEL

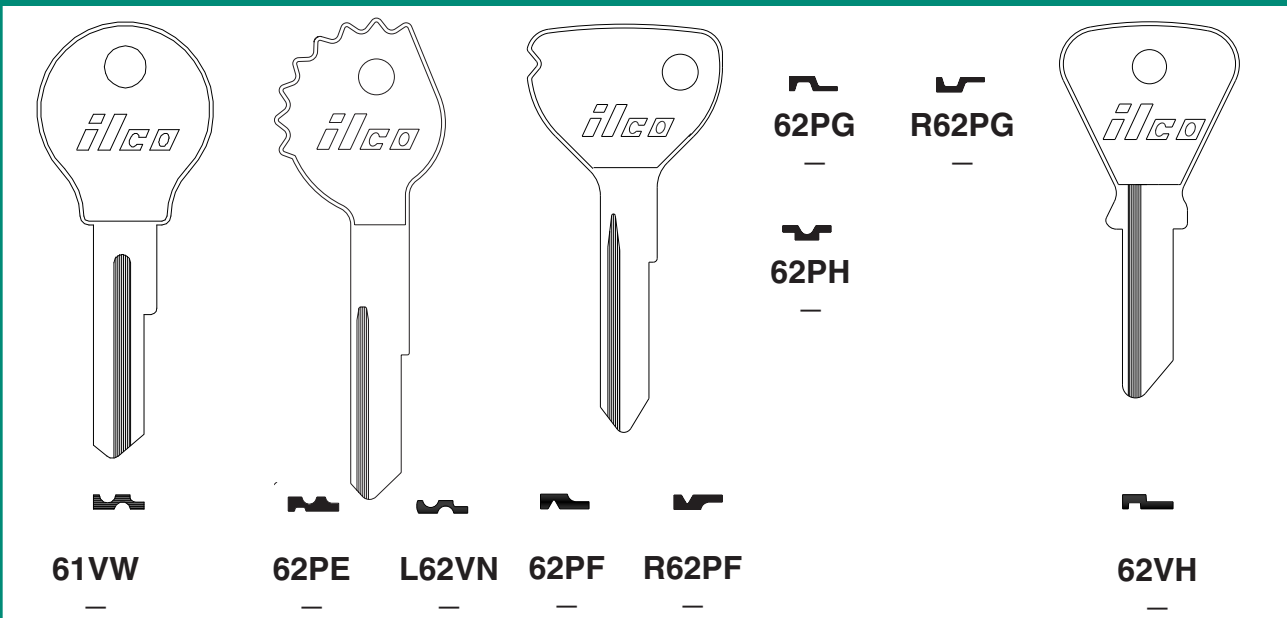

61VW

62PE

L62VN

62PF

R62PF

62PG

R62PG

62PH

62VH

ILCO
EZ

OPEL

						62WA
						—
						R62PE
						—
						63Y
						—
62VJ	62VM	62VO	62VP	A62VN		
—	—	—	—	—		

ILCO
EZ

VEHICLE

sec 1 page 113

OPEL

H62PD	HR62PD	H62VP	L62VJ	LR62VJ	S62VP	S62VT
—	—	—	—	—	—	—

ILCO
EZ

OPEL

			O79JC	O79JD	
63LL	U63H	O79JE			OP91G
—	—	—			—

ILCO
EZ

OPEL PANHARD

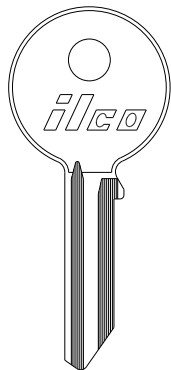

OP91S

—

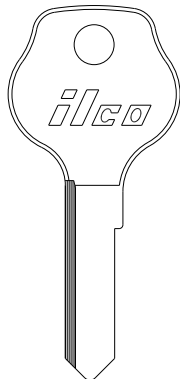

OP91SV

—

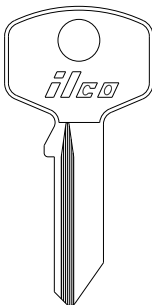

Y91C

—

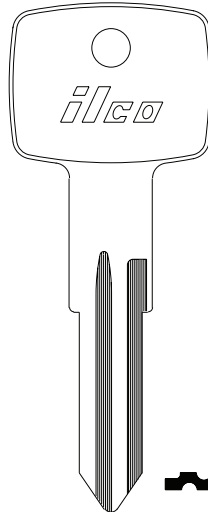

X168

B61



PA1

—

ILCO
EZ

PANHARD



7DC

—

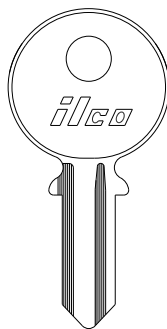

62BZ

—

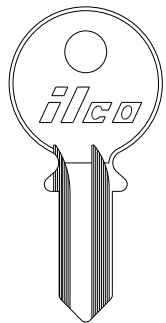

R62BZ

—

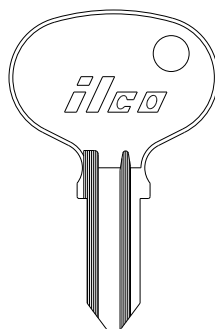

62R

—

H64K

—

HR64K

—



P64K

—

P65A

—

P65C

—

P64H

—

ILCO
EZ

PANHARD PANTERA PETERBILT

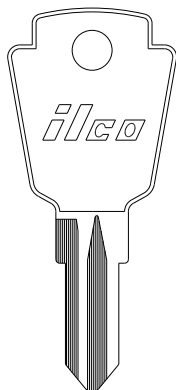

PA91

—

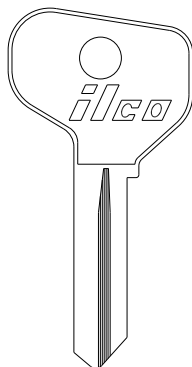

FT37 FT38

—

—

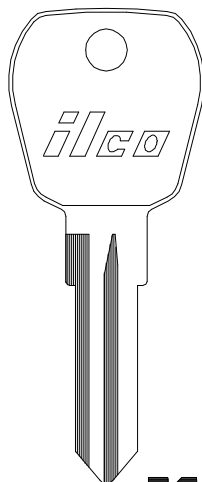

X86

FC7

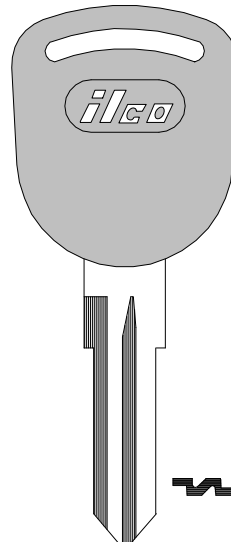

FC7-P

—

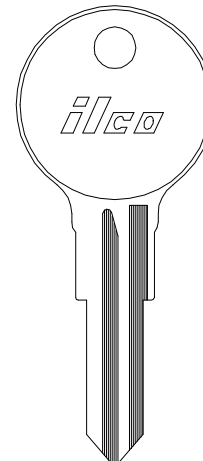

X53

V32

ILCO
EZ

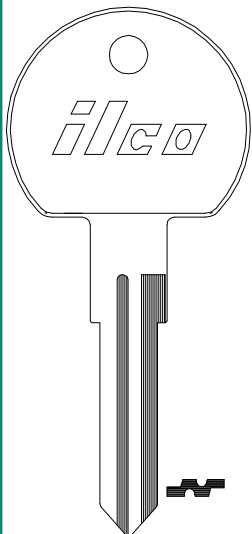
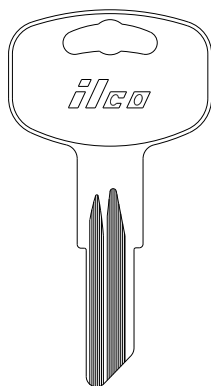
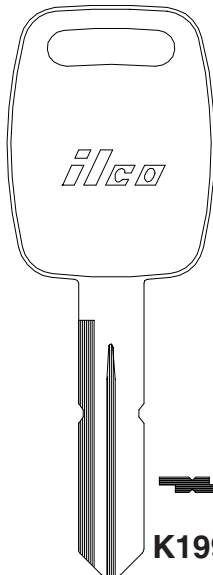
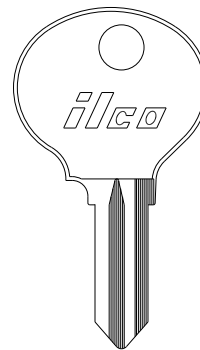
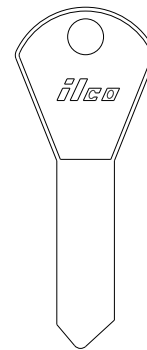
PETERBILT
PEUGEOT

X170
NE48

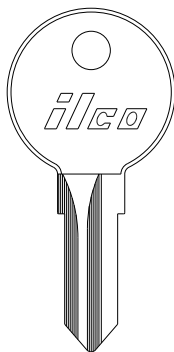
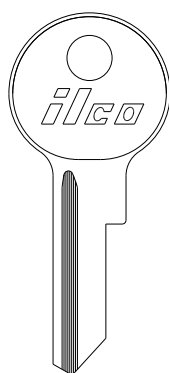
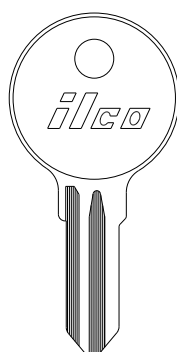
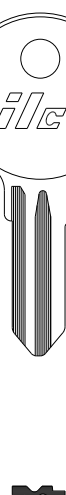
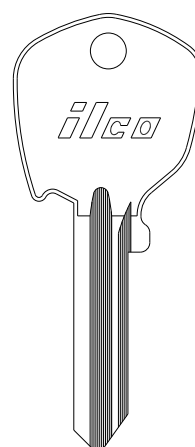
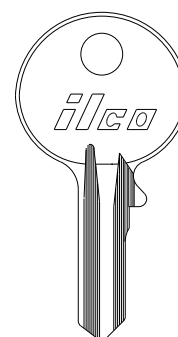
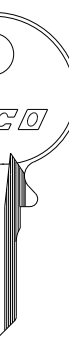
1098PB
—

K1994
—

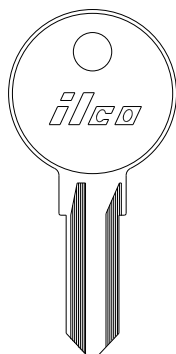
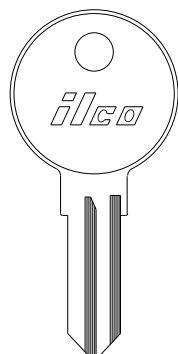
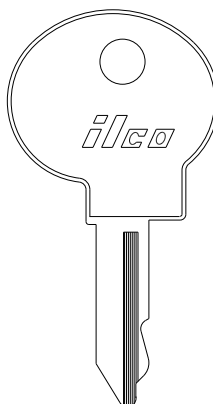
KM1
—

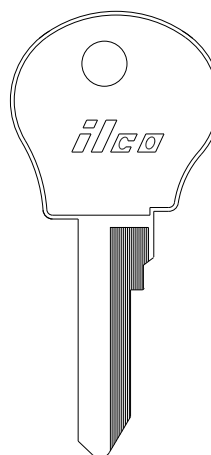
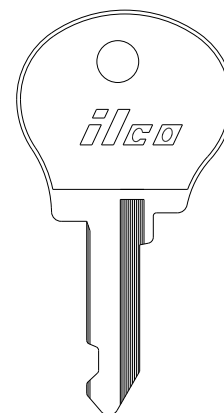
LA1
—

ILCO
EZ

PEUGEOT

KM2
—

KM3
—

NE4
—

SM4
—

FT6
—

7DC
—

R7DC
—

ILCO
EZ

PEUGEOT

KM8
—

X89
KM9

KM10
—

NE11
—

X12
RE61F

NE18
—

ILCO
EZ

PEUGEOT

						NE42 —
						NE43 —
RT19	NE27	NE31	NE39	NE41		
—	—	—	—	—		

ILCO
EZ

PEUGEOT

NE44	NE45	NE47	NE46	61PE	61PS	RE61XR	
—	—	—	—	—	—	—	

ILCO
EZ

PEUGEOT

											N63G NR63G — —
V61S	VR61S	62Z	R62Z	L62UC	63G	R63G	63H	R63H			
—	—	—	—	—	—	—	—	—			

ILCO
EZ

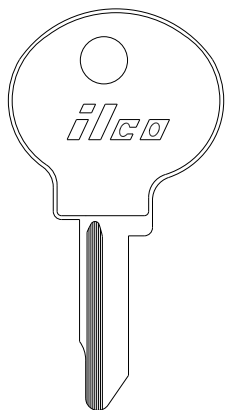
PEUGEOT

63M

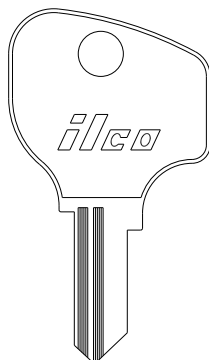
—

63Q

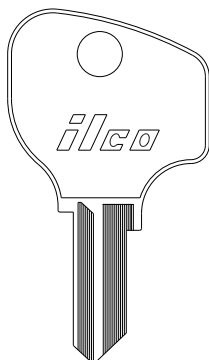
—

63P

—

63PX

—

R63PX

—

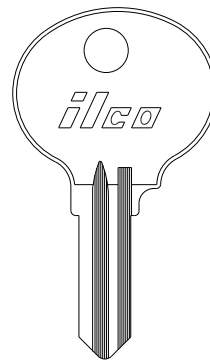
H63G

—

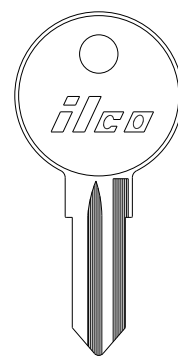
L63G

—



LR63G

—

**ILCO
EZ**

sec 1 page 117

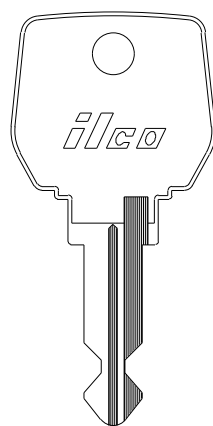
VEHICLE

PEUGEOT

X116

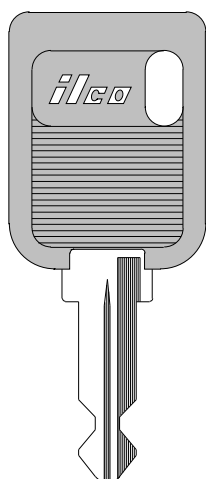
RN24

RN24-P

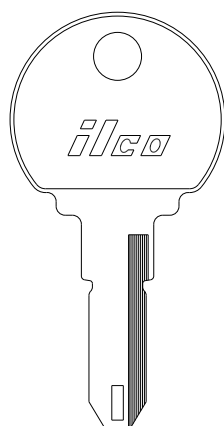
—

X147

RN30

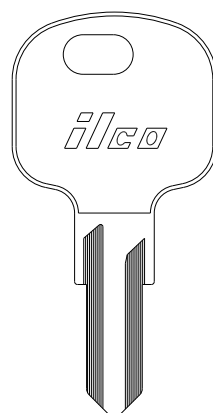
X148

PG5

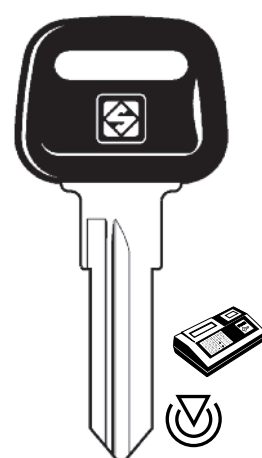
PEUGEOT MOTORCYCLE

NE74T5-SI

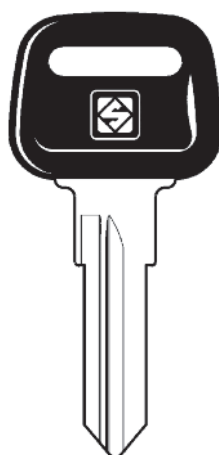
—

**ILCO
EZ**
PEUGEOT MOTORCYCLE

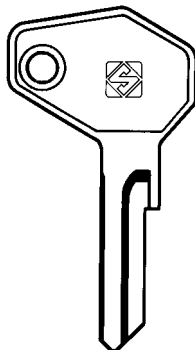
NE74P-SI

—

ZD7-SI

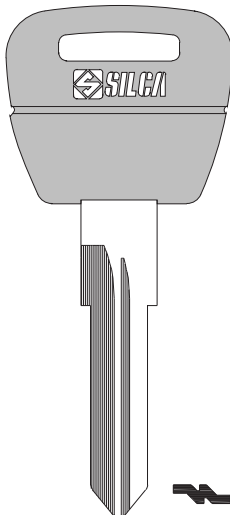
—

NE71RDP-SI

—

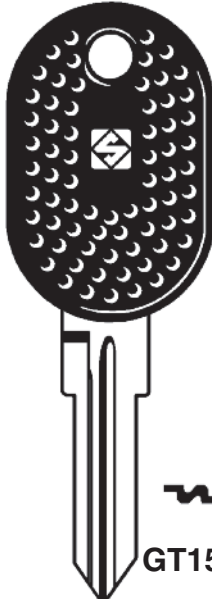
PIAGGIO

GT15RP-SI

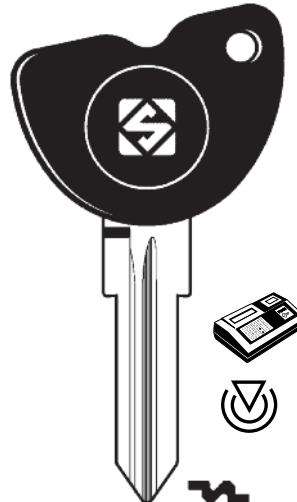
—

GT15RDT5-SI

—

**ILCO
EZ**

PIAGGIO

GT15RAP	ZD17RAP-SI	ZD16RP-SI	SIP22T5-SI	X270 TMC1

ILCO
EZ

PIPER AIRCRAFT PLYMOUTH POLARIS

	SEE CHRYSLER				
O1122 Y11			HD51	752	1041GB

ILCO
EZ

POLARIS

1041GR	1041K	CH3	CH7	X117 YH48

ILCO
EZ

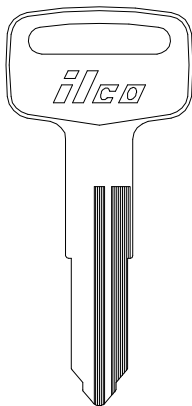
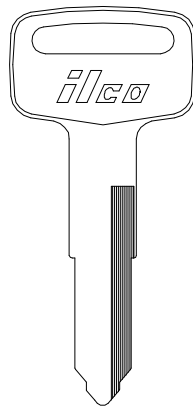
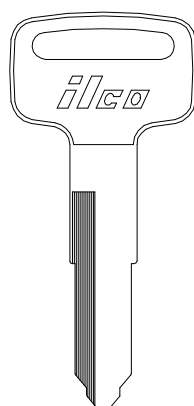
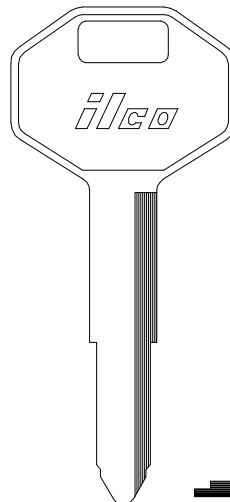
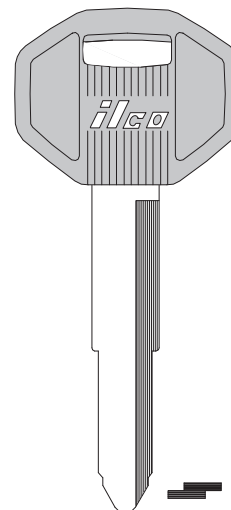
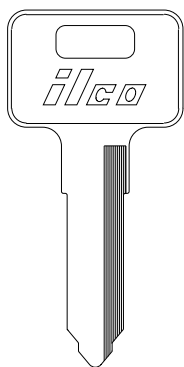
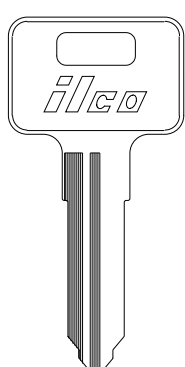
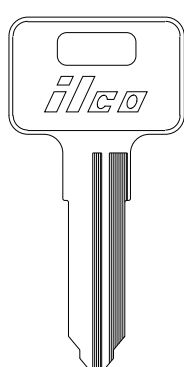
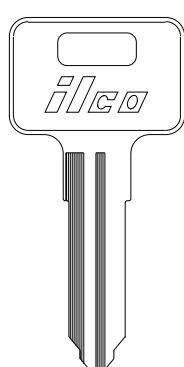
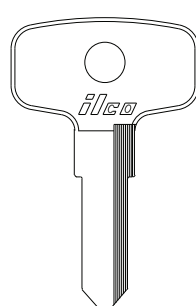
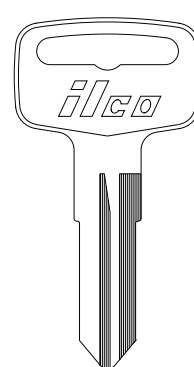
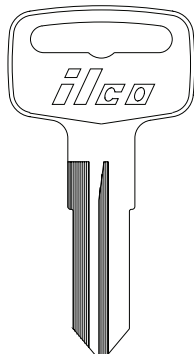
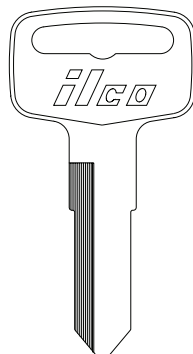
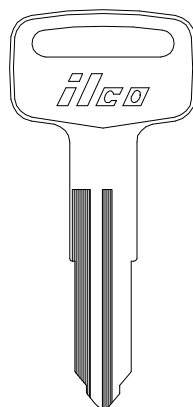
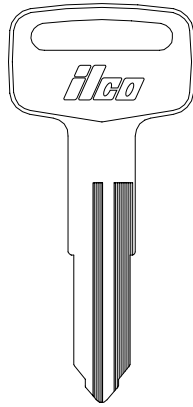
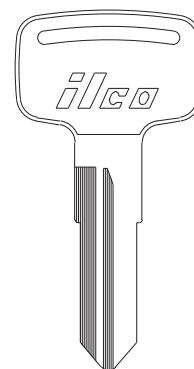
POLARIS**X118**
YH49**X119**
YH47**X120**
YH46**X121**
DC3**DC3-P (-PC)**
—ILCO
EZ**POLARIS****X259**
—**X260**
—**X261**
—**X262**
—**YH26**
—**YH33**
—ILCO
EZ**POLARIS****YH34**
—**YH38**
—**YH50**
—**YH51**
—**YM55**
—ILCO
EZ

POLARIS PONTIAC PORSCHE

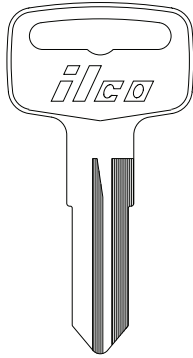

YM56

—

SEE
GENERAL
MOTORS
(GM)

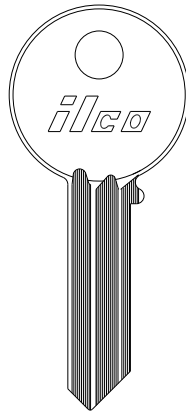

BZK1

—

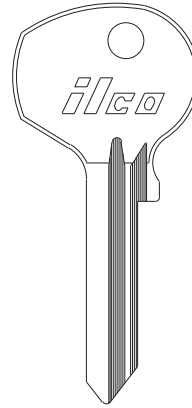

KP1

—

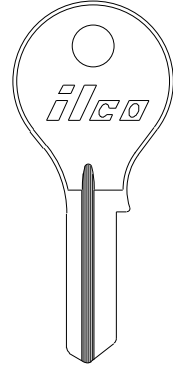

PO2

—

ILCO
EZ

PORSCHE

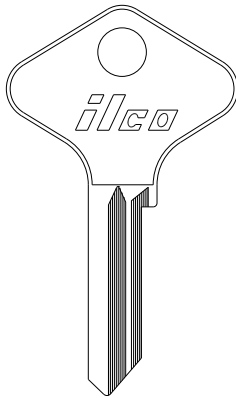

DM2

—

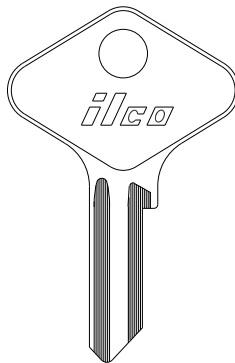

DM3

—

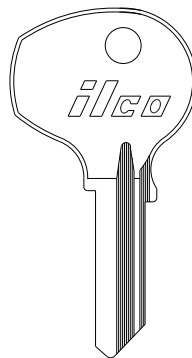

DM4

—

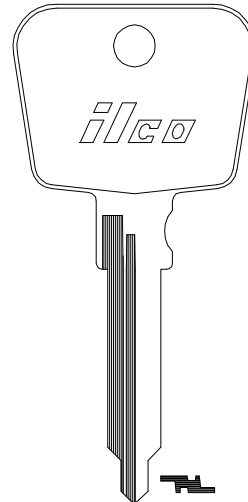

PO5

—

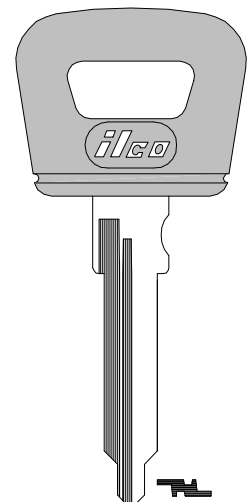

PO5-P

—

ILCO
EZ

PORSCHE

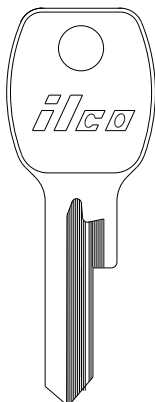

WS5

—

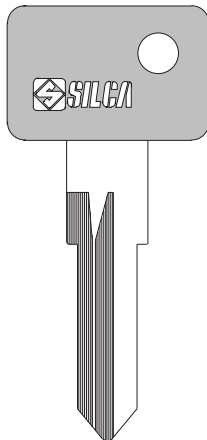

ZD14RP

—

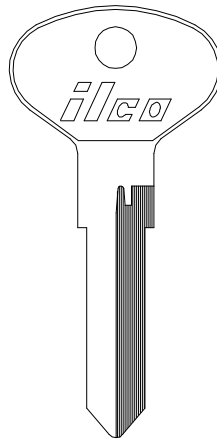

X9

73VB

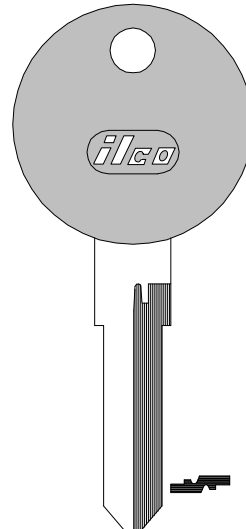

73VB-P

—

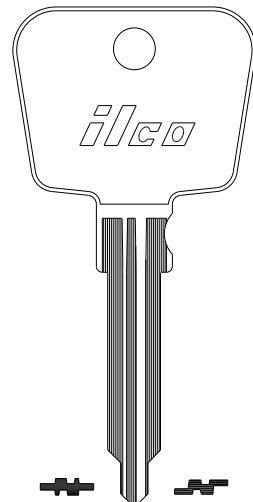

X32

PO6

PO7

—

ILCO
EZ

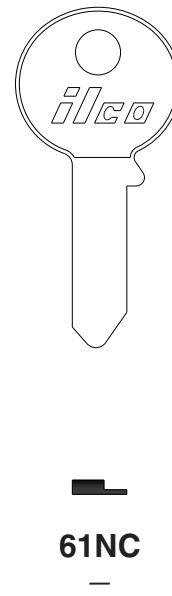
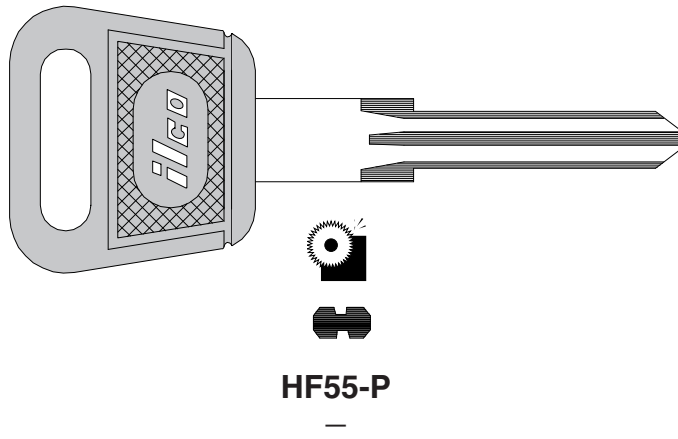
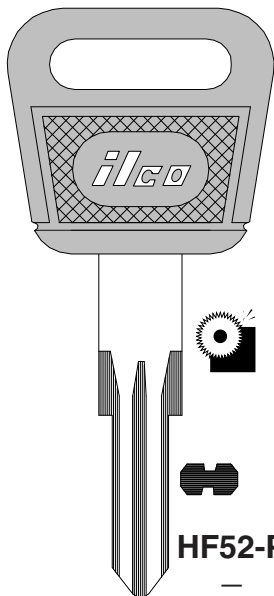
PORSCHEILCO
EZsec
1 page
121

VEHICLE

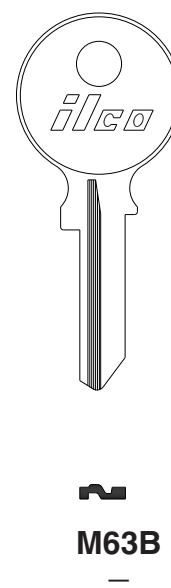
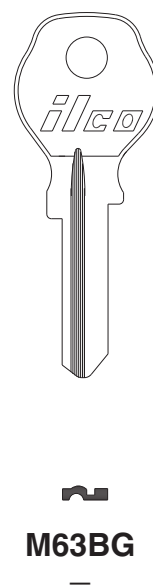
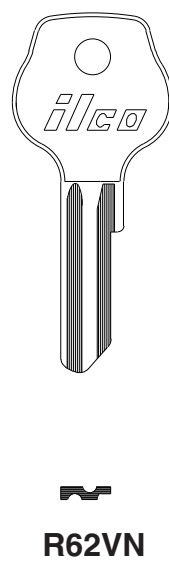
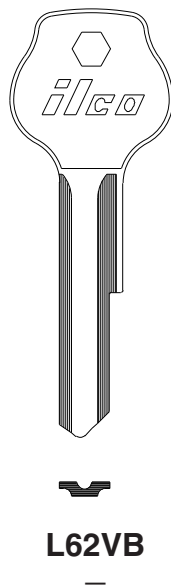
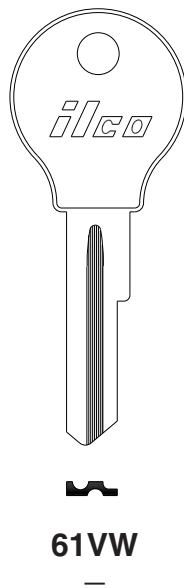
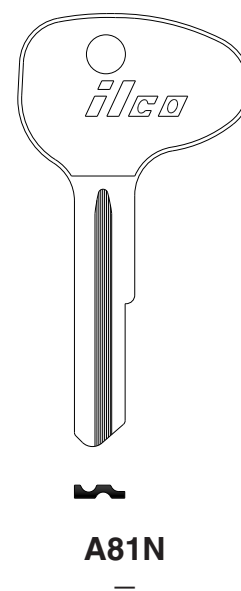
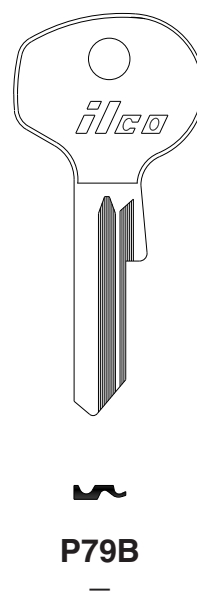
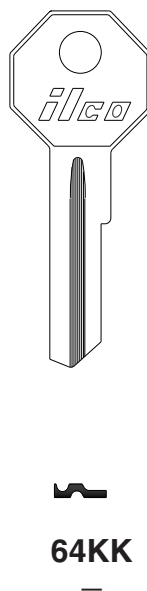
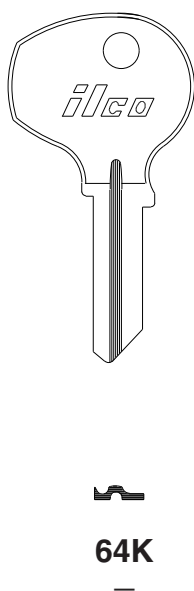
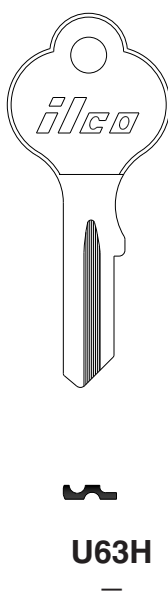
PORSCHEILCO
EZ**PORSCHE**ILCO
EZ

PORSCHE - RENAULT





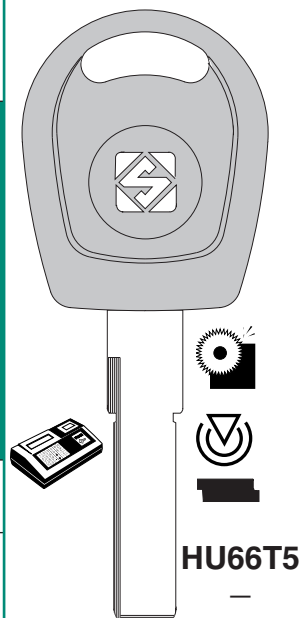
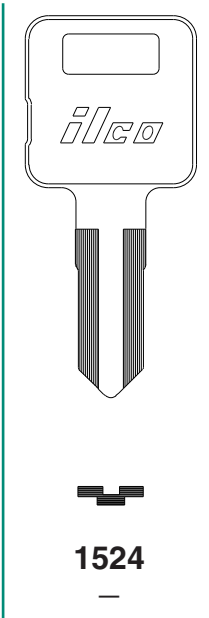
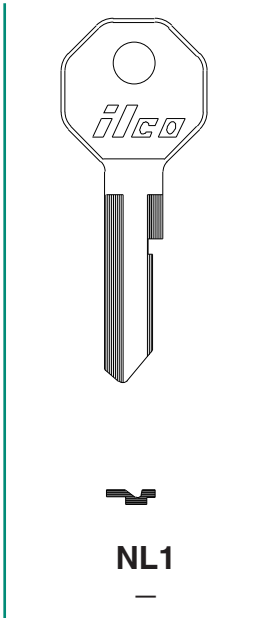
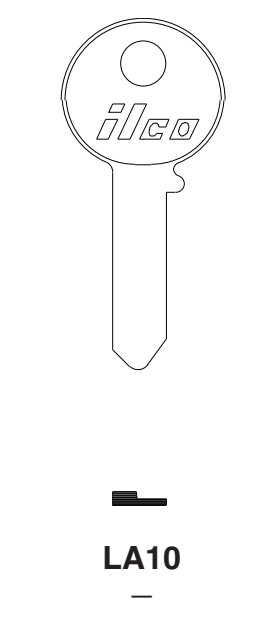
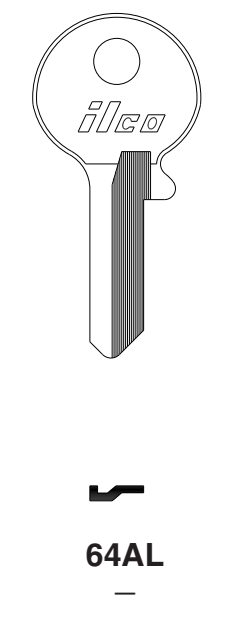

VEHICLE

sec 1 page 122

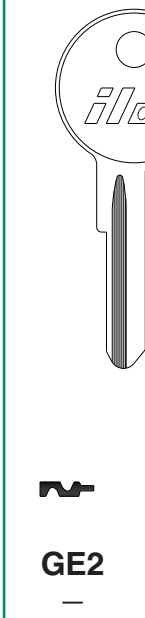
PORSCHE POST OFFICE PRINCE

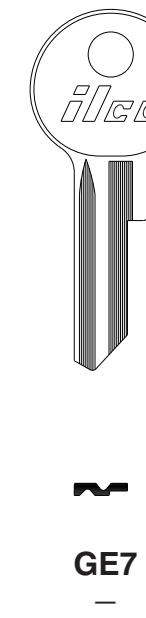
 <p>HU66T5 —</p>	 <p>1524 —</p>	 <p>NL1 —</p>	 <p>LA10 —</p>	 <p>64AL —</p>	<p>ILCO EZ</p>
---	---	--	--	---	--------------------

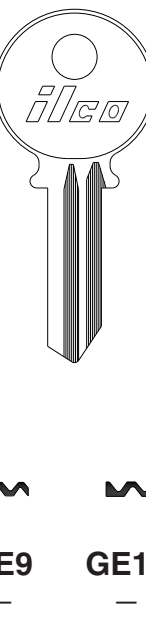
PUCH-SEARS

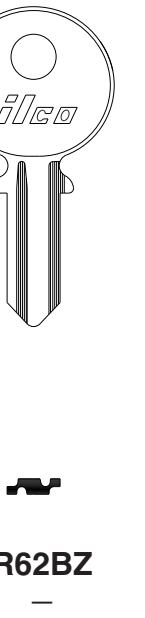
 <p>GE2 —</p>	 <p>GE4 —</p>	 <p>GE7 —</p>	 <p>GE9 —</p>	 <p>GE14 —</p>	 <p>R62BZ —</p>	 <p>64P —</p>	<p>ILCO EZ</p>
---	---	---	---	--	--	---	--------------------

PUCH-SEARS RALEIGH CYCLE RENAULT

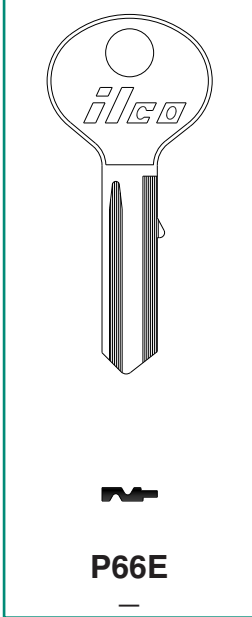
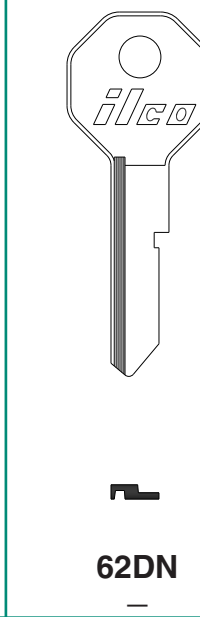
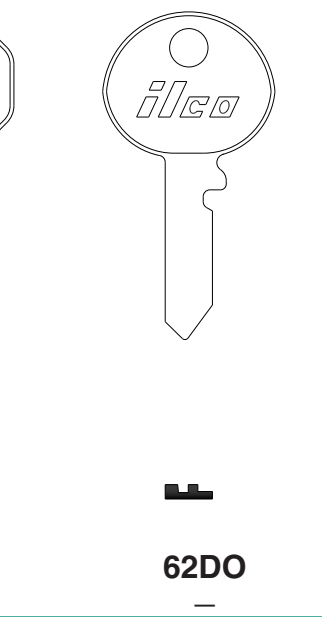
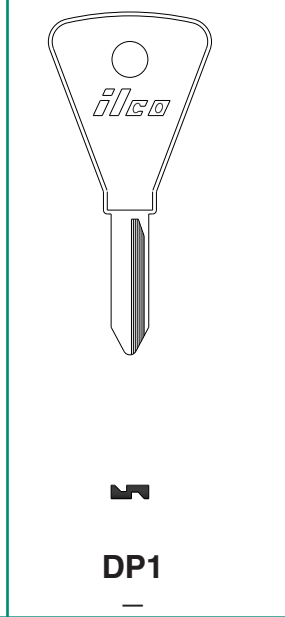
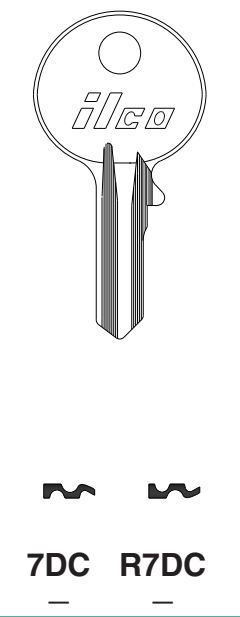
 <p>P66E —</p>	 <p>62DN —</p>	 <p>62DO —</p>	 <p>DP1 —</p>	 <p>7DC R7DC — —</p>	<p>ILCO EZ</p>
---	---	---	---	---	--------------------

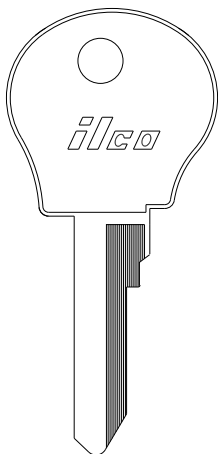
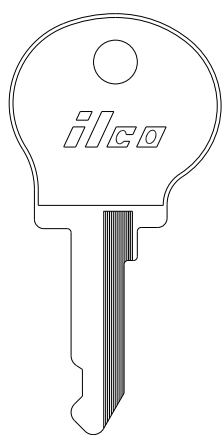
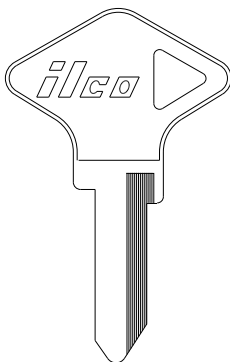
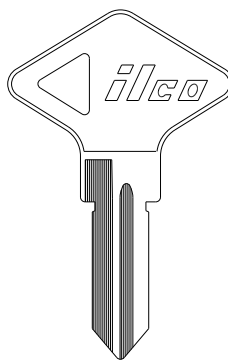
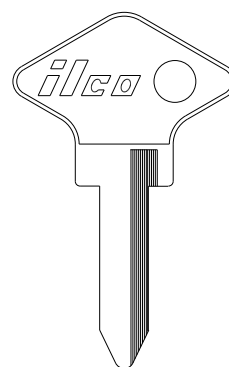
RENAULT**X12**
RE61F**NE13**
—**NE14**
—**NE15**
—**NE16**
—**NE29**
—ILCO
EZ

sec 1 page 123

VEHICLE

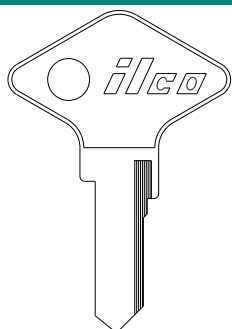
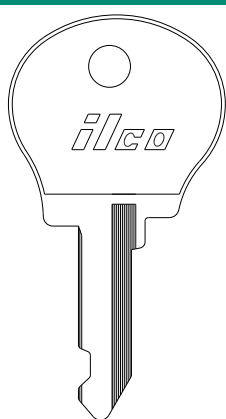
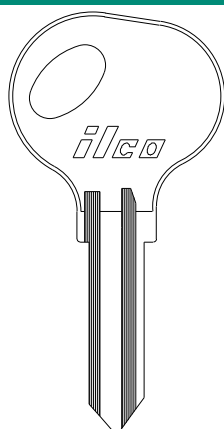
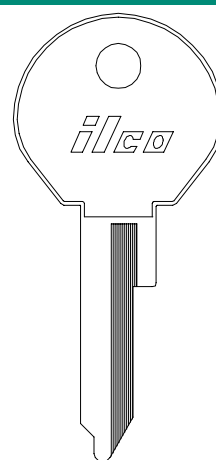
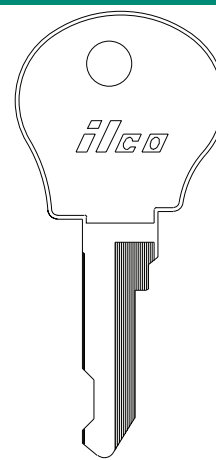
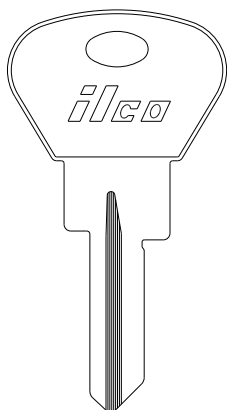
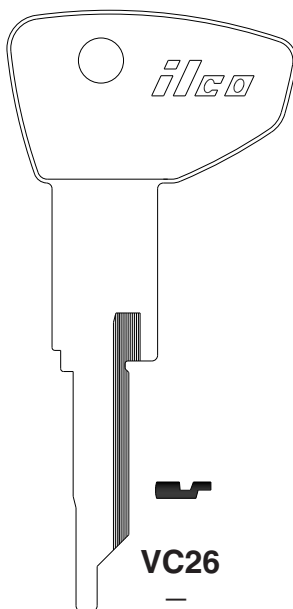
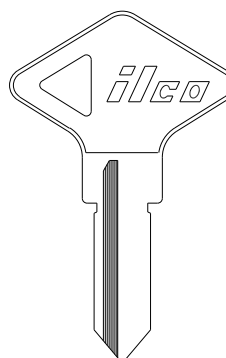
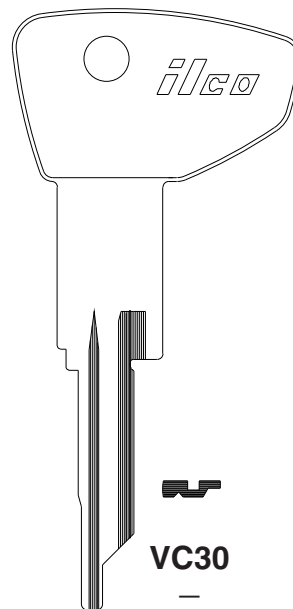
RENAULT**NE17**
—**NE18**
—**RT19**
—**NE20**
—**NE22**
—ILCO
EZ**RENAULT****VC24**
—**VC26**
—**VC29**
—**VC30**
—ILCO
EZ

RENAULT

NE33 —	NE39 —	NE45 —	HV61 HVR61 — —	RE61N —	ILCO EZ

RENAULT

RE61XR —	V61S —	VR61S —	X61 NE40	62VC —	ILCO EZ

RENAULT

62R —	62U —	R62UC —	62Z —	R62Z —	63M —	63Q —	64R —	64X —	P64K —	ILCO EZ

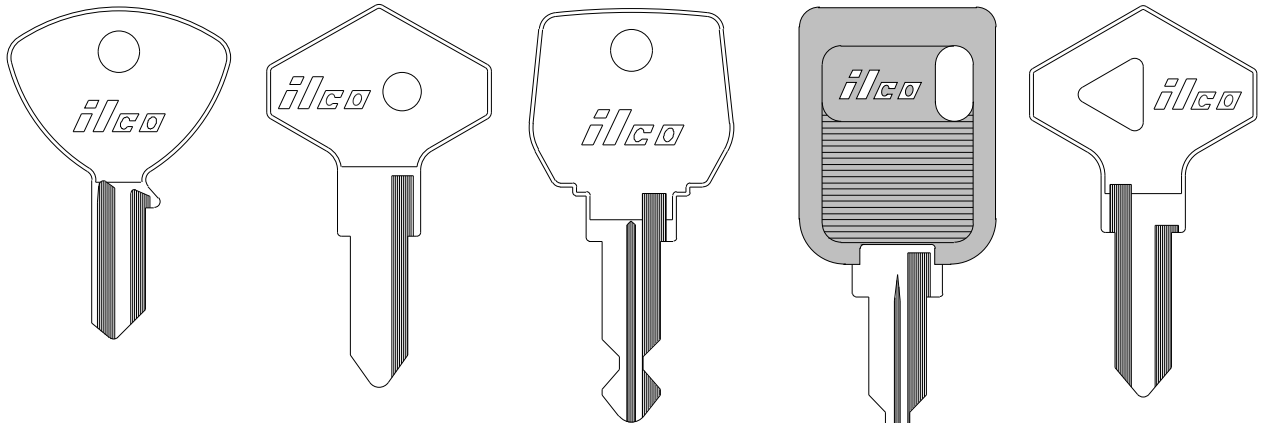
RENAULT

R80B
—



X85
NE36



X92
RN25



X116
RN24



RN24-P
—



X122
RN29

ILCO
EZ

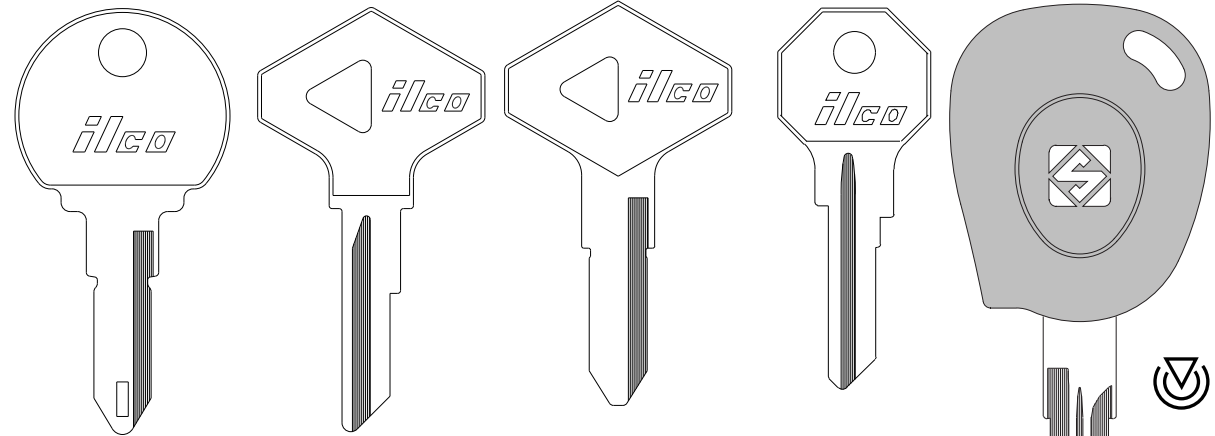
RENAULT

X147
RN30



X150
RN27



X171
RN31



H199N
—



VAC102T1
—

ILCO
EZ

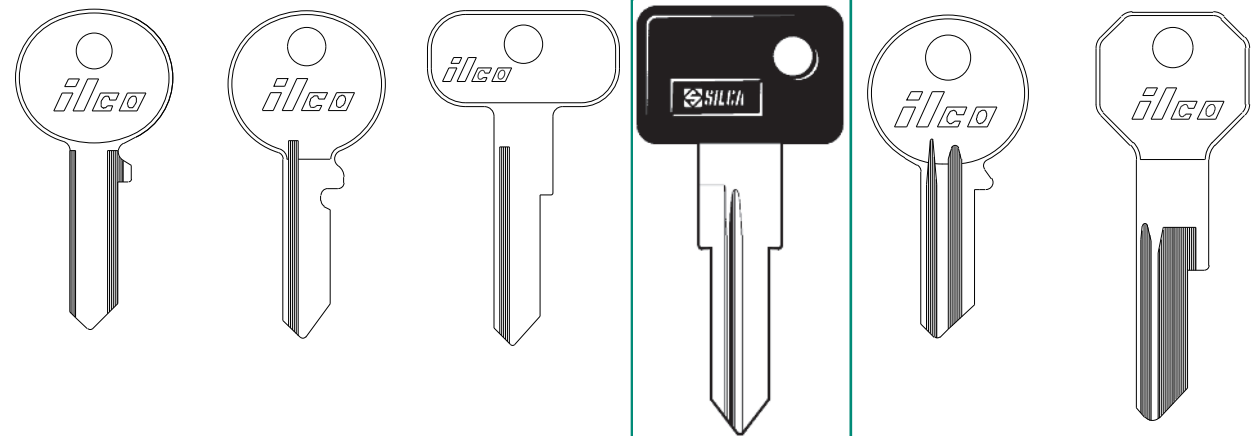
RILEY
RIZZATO
ROLLS ROYCE

62DB
—



62DP
—



H62DP
—



ZD16RP-SI
—



YL5
—



X28
62HE

ILCO
EZ

ROLLS ROYCE/BENTLEY

VEHICLE



62HA

—



62HB

—



62HC

—



62HD

—



62HF

—



62HG

—

ILCO
EZ

sec 1 page 126

ROLLS ROYCE/BENTLEY ROOTES GROUP

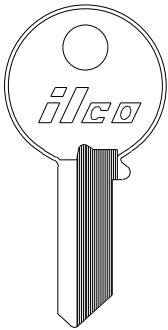

62JB

—



SR1

—

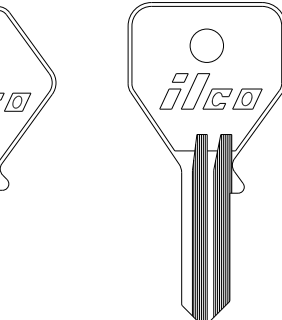

SR2

—

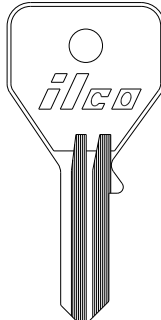

BR5

—

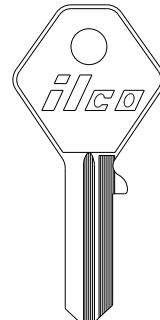

BR6

—

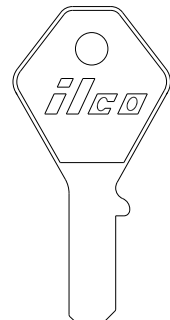

BR7

—

ILCO
EZ

ROOTES GROUP

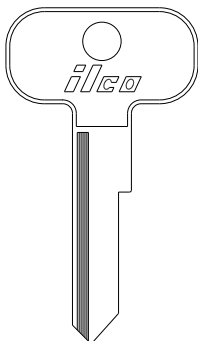

BR9

—

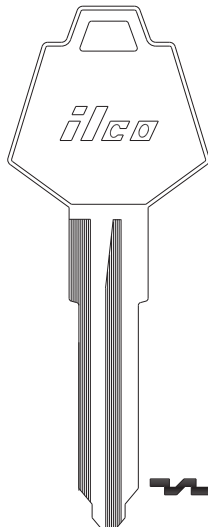

X16

P1771CR

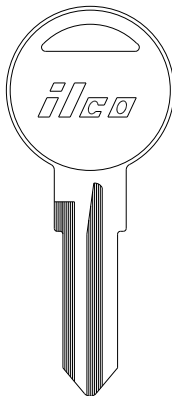

X17

S1771CR



62DC

—



62DG

—



R62DG

—



62DH

—



62DP

—



F70S

—



M72F

—

ILCO
EZ

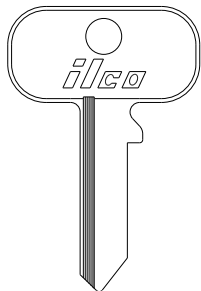
ROOTES GROUP
ROVER

B62DR

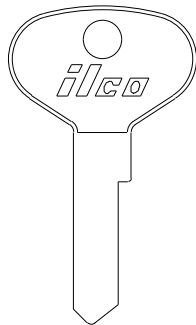
—

H62DG

—

HR62DG

—

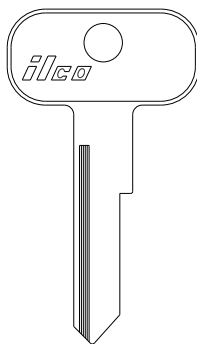
H62DP

—

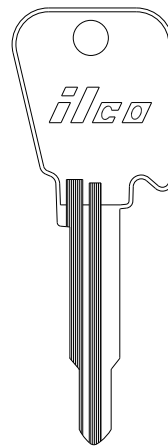
X13

LF4

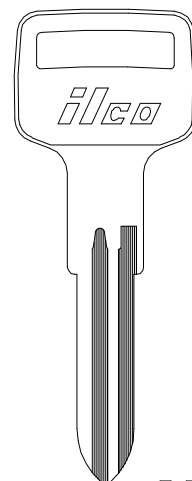
X29

VO73

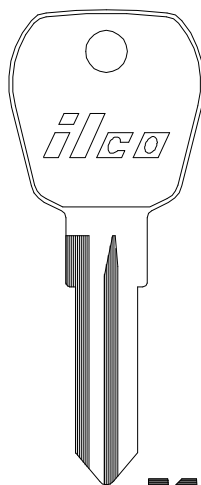
**ILCO
EZ**
ROVER

X86

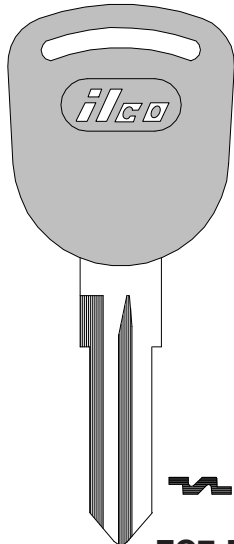
FC7

FC7-P

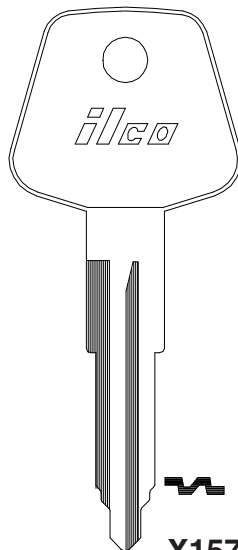
—

X157

LF17

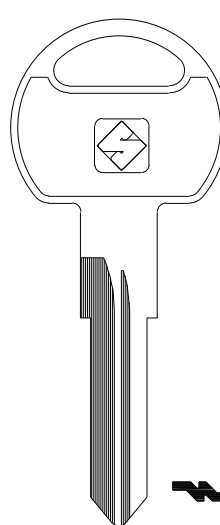
NE71R

—

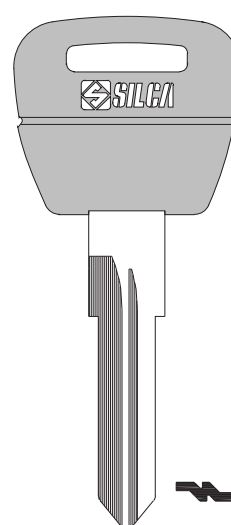
NE71RDP

—

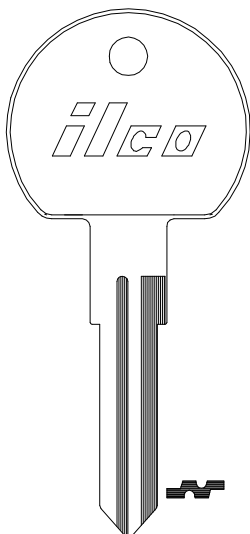
**ILCO
EZ**
ROVER

X170

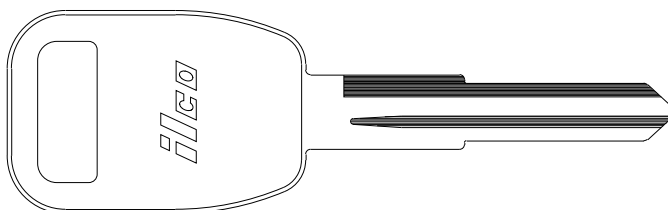
NE48

X239

RV4

**ILCO
EZ**

ROVER

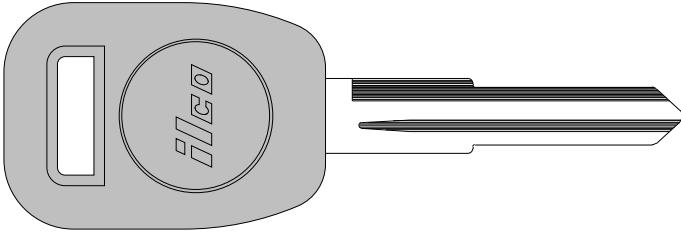

RV4-P

—

ILCO
EZ

ROVER SAAB

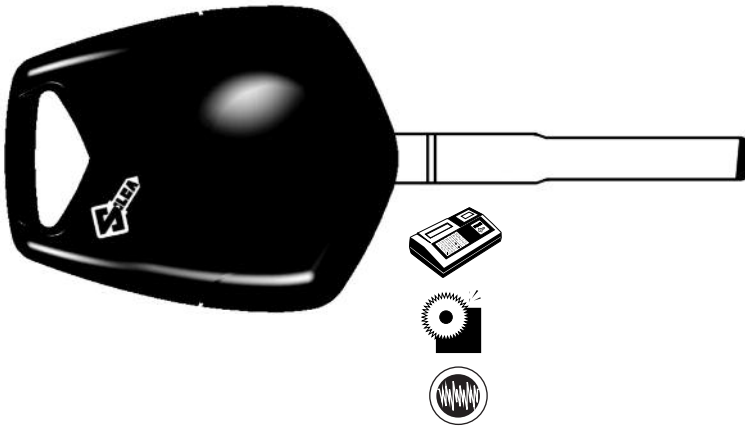

HU101EHP

—

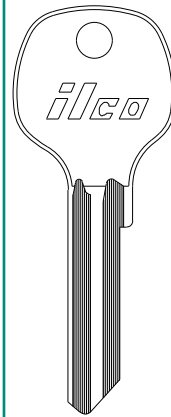

SB1

—

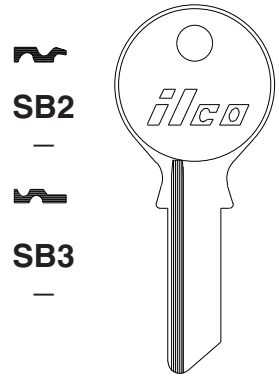

SB2

—



SB3

—



SB4

—

ILCO
EZ

SAAB

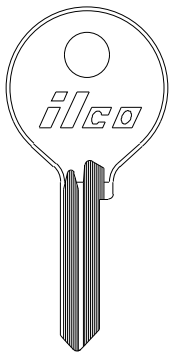

SB5

—

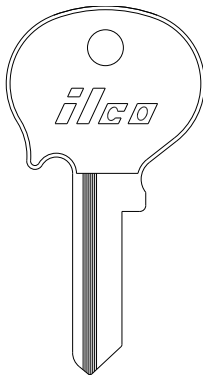

NE5

—

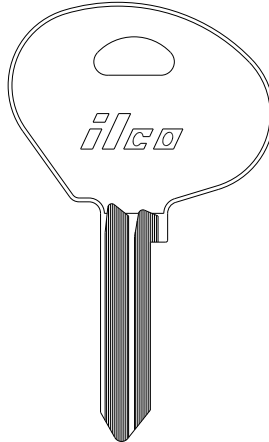

SB6

—

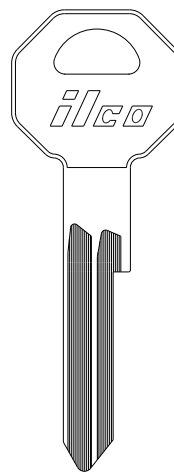

SB7

—

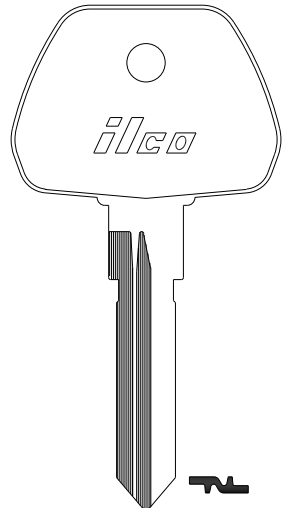

SB10

—

ILCO
EZ

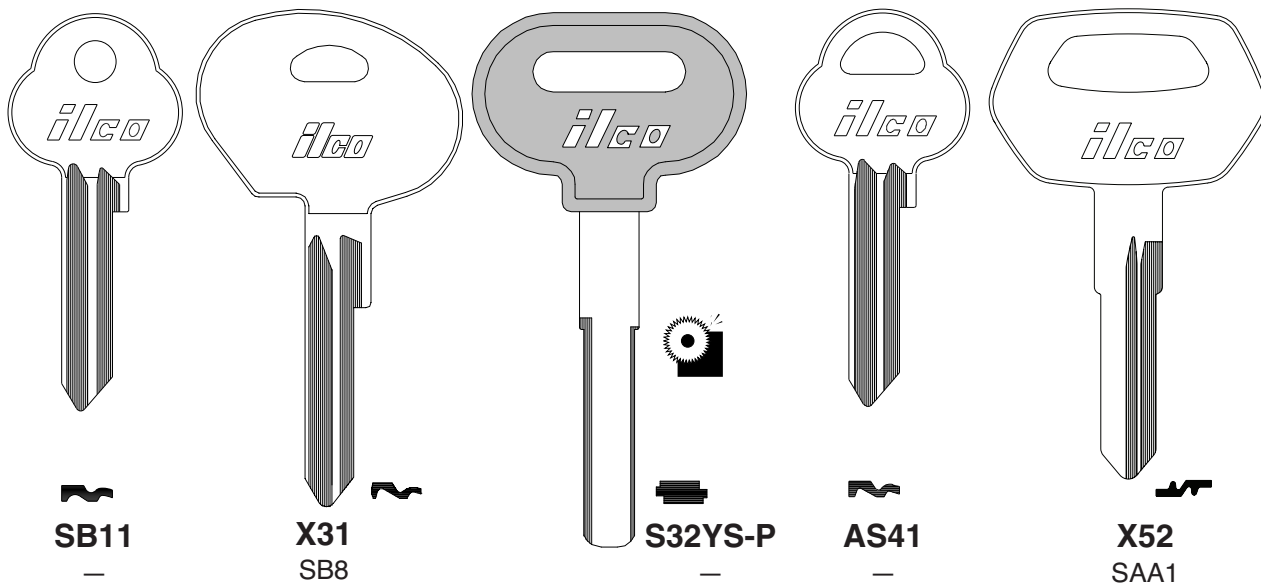
SAABILCO
EZ

sec 1 | page 129

VEHICLE

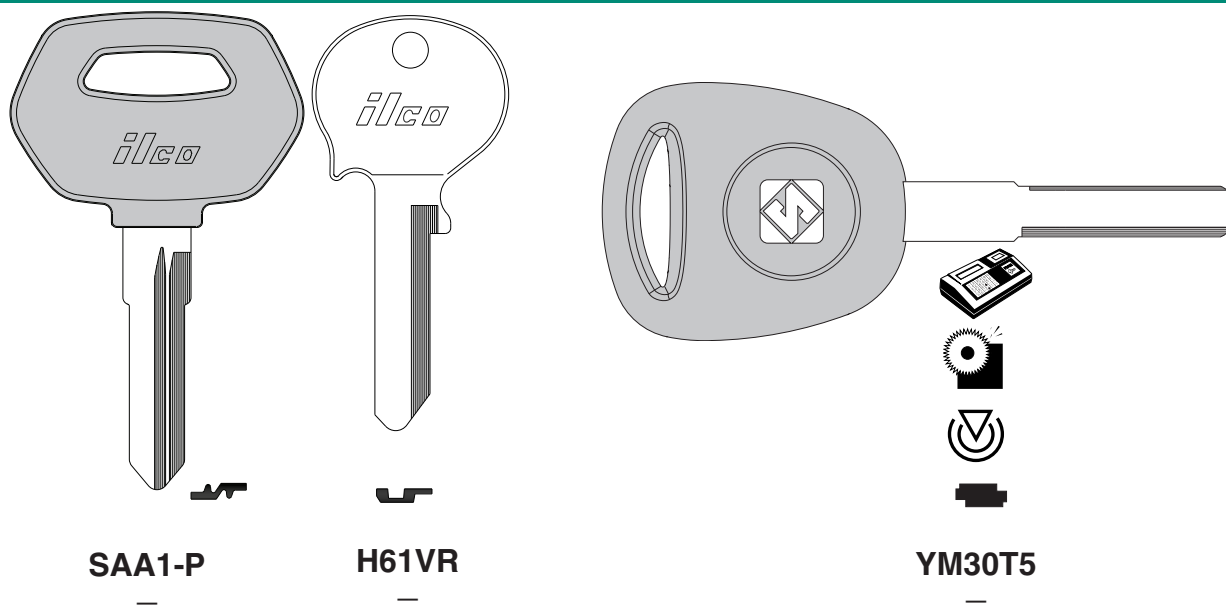
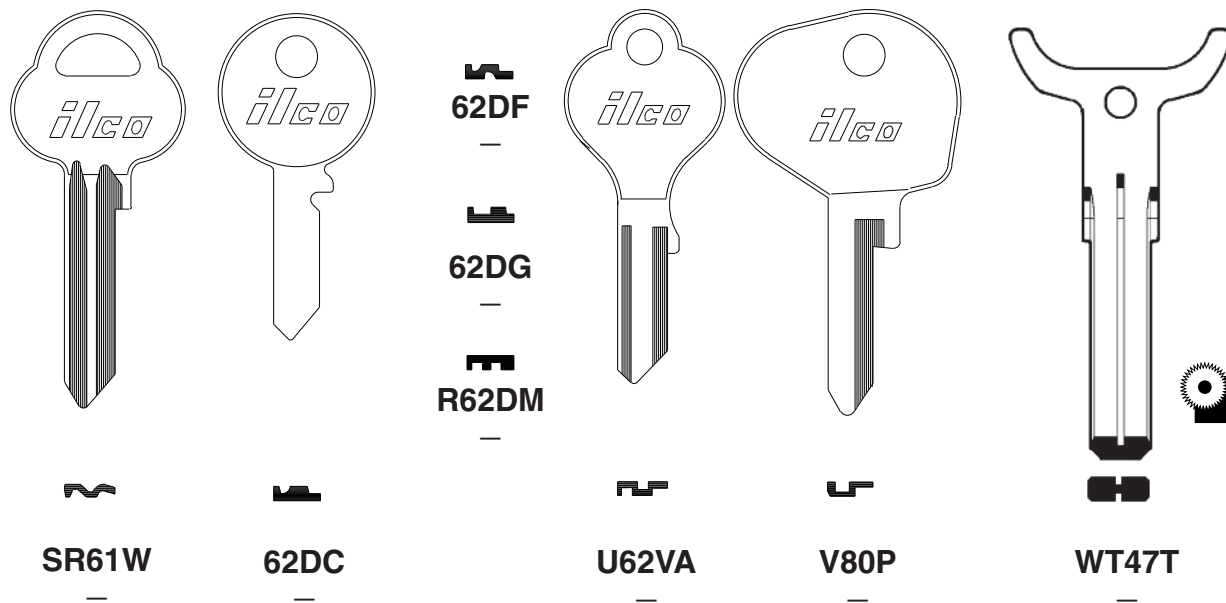
SAABILCO
EZ**SAAB**ILCO
EZ

SATURN

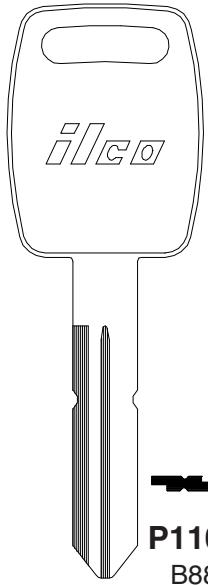

P1108
B88

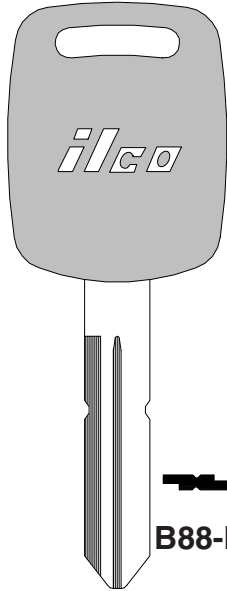

B88-P (-PC)
—

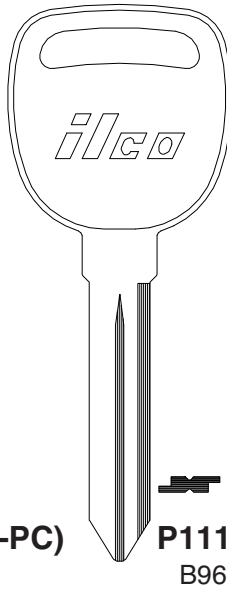

P1110
B96

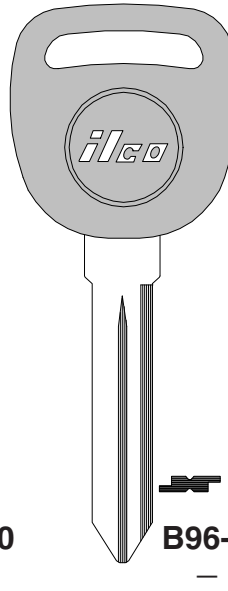

B96-P
—

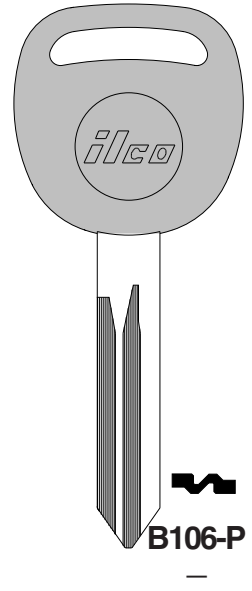

B106-P
—

ILCO
EZ

SATURN

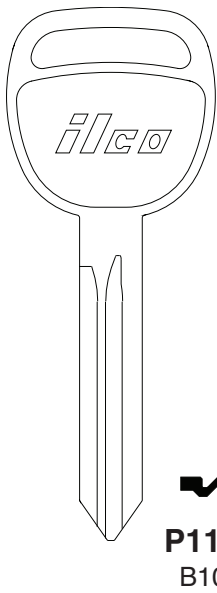

P1115
B106

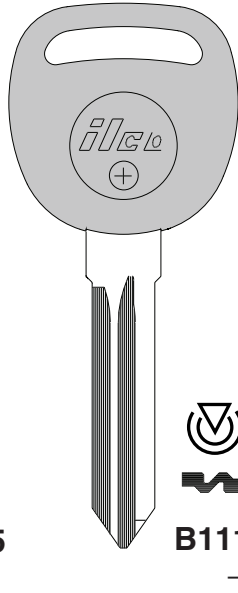

B111-PT
—

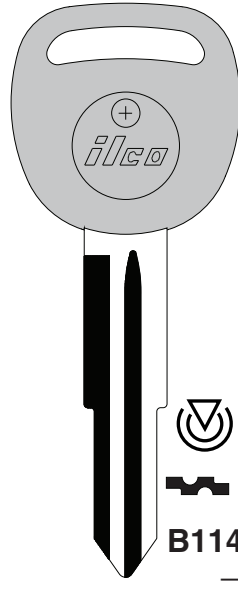

B114-PT
—

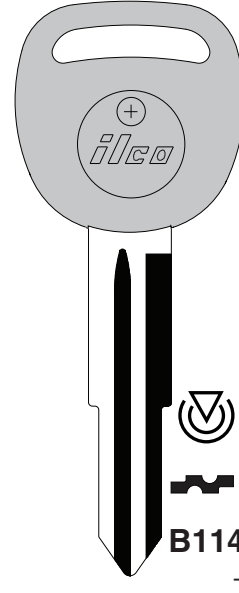

B114R-PT
—

ILCO
EZ

SATURN

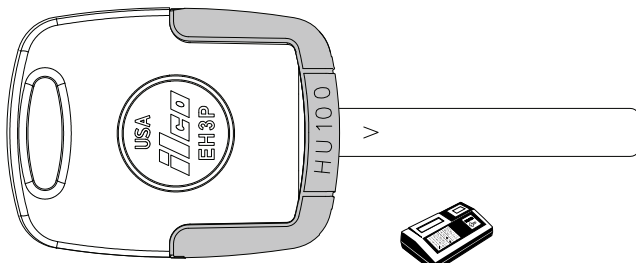

EH3P
(Head Only)

EB3-V-HU100
(Blade Only)



EK3P-HU100
(Complete Key)

ILCO
EZ

SATURN

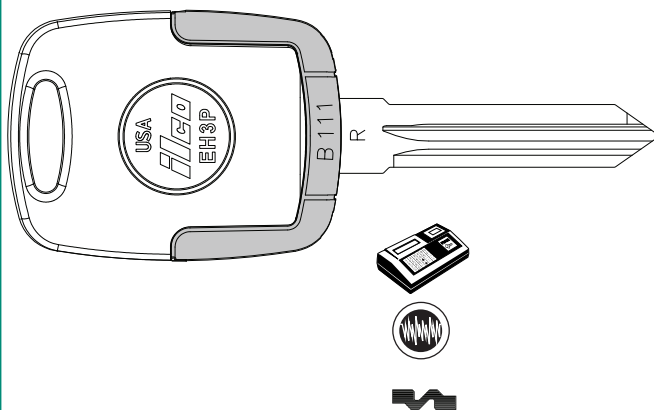

EH3P
(Head Only)

EB3-R-B111
(Blade Only)

EK3P-B111
(Complete Key)

ILCO
EZ

SATURN

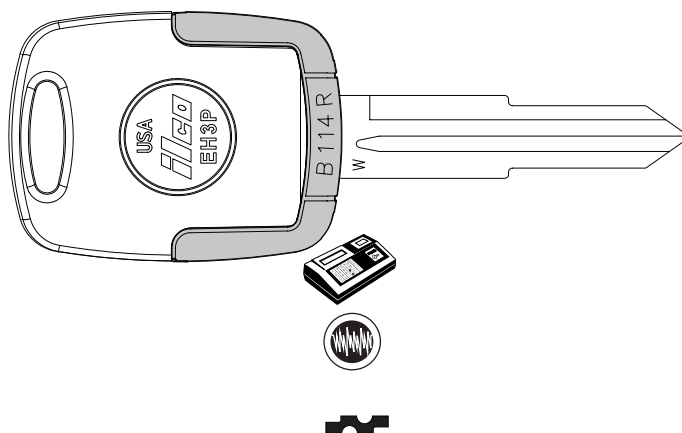

EH3P
(Head Only)

EB3-W-114R
(Blade Only)



EK3P-B114R
(Complete Key)

ILCO
EZ

SATURN

SCISSOR LIFT

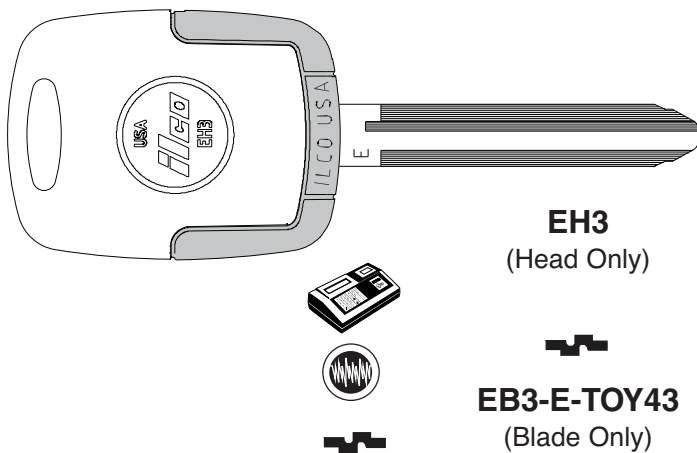
SEAT



EH3
(Head Only)



EB3-E-TOY43
(Blade Only)

TOY43-EK3
(Complete Key)

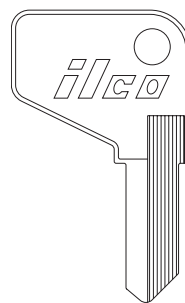
ILCO
EZ

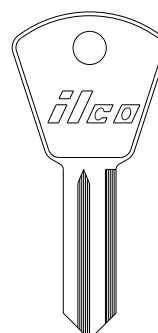

1627
—



SE1B
—



SE2B
—

SE3B
—

SE4B
—

SEAT

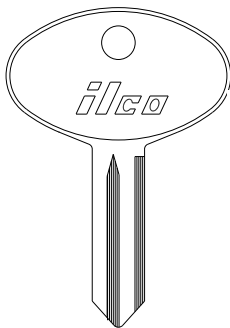
SIMCA/TALBOT/MATRA





SE1C

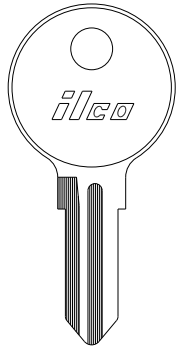

SE2C
—

SE3C
—

SE4C
—



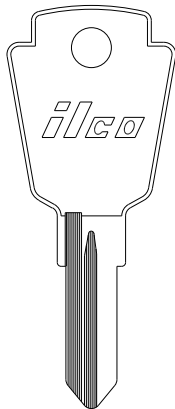

SE5F

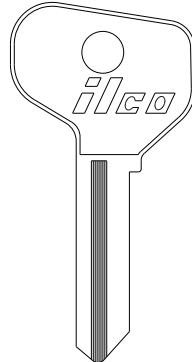

SMS8

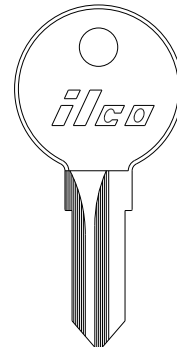

F54





KM2

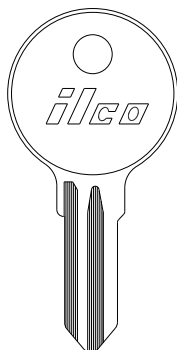

KM3

ILCO
EZ

SIMCA/TALBOT/MATRA



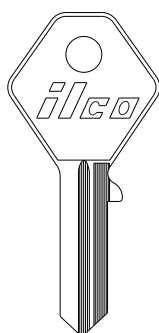

SM4



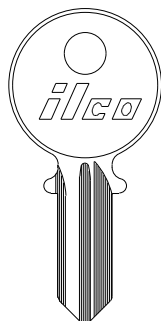

BR6

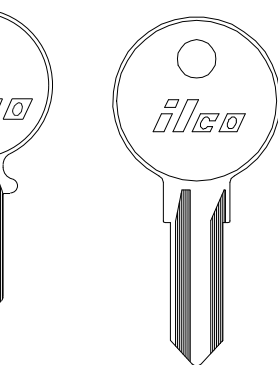



SM6

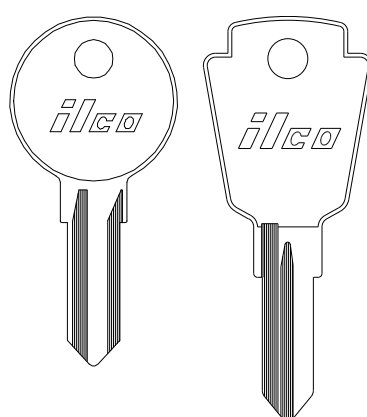



SM7

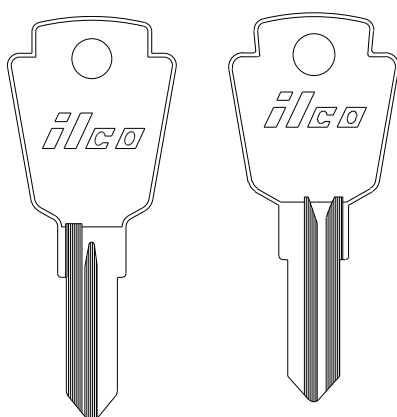



KM8

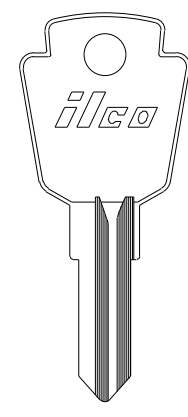

SMS8



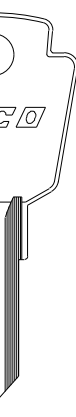

SM9C



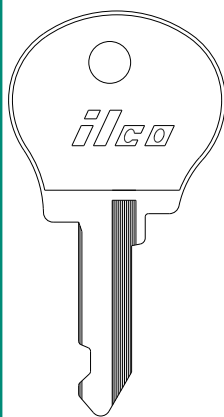

S91W

ILCO
EZ

SIMCA/TALBOT/MATRA



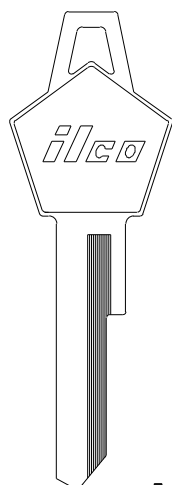

NE18

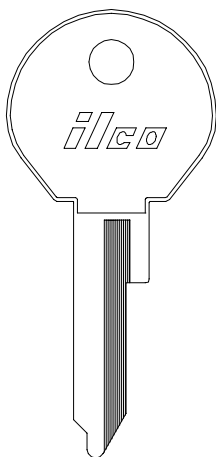

NE19



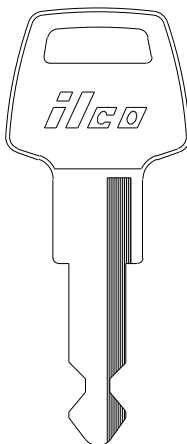

NE20



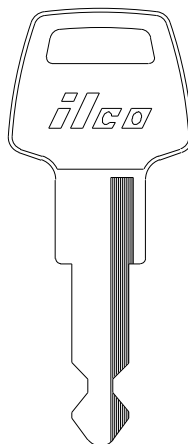

NE26

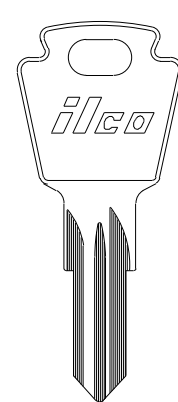

NE34



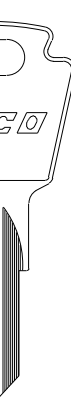

61P

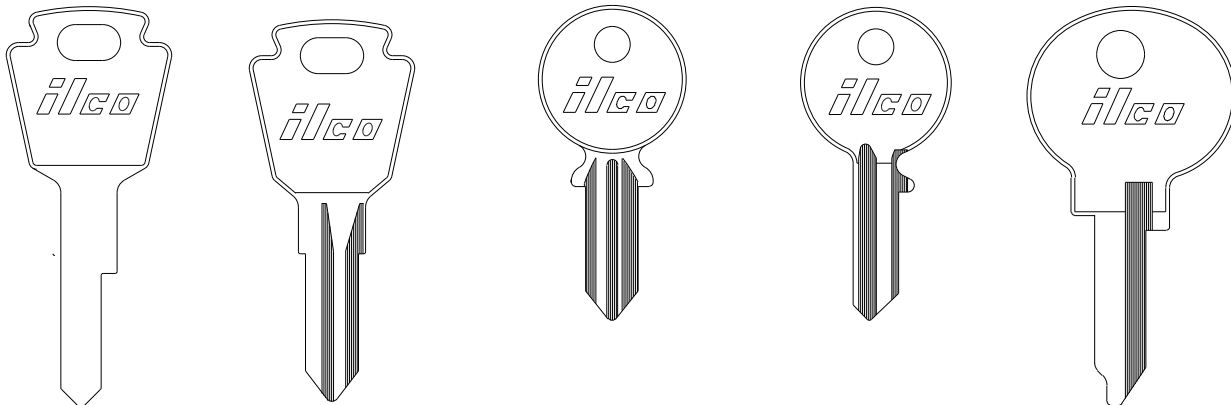

R61P

ILCO
EZ

SIMCA/TALBOT/MATRA

61PC	61PE	61PS	H61P	HR61P	HV61	HVR61	RE61XR
—	—	—	—	—	—	—	—

**ILCO
EZ**

sec 1 page 133

VEHICLE

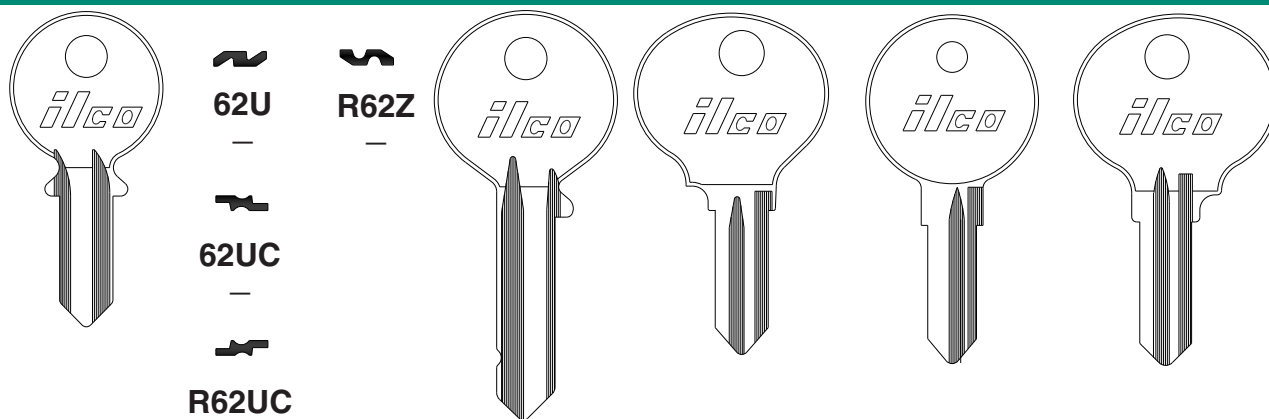
SIMCA/TALBOT/MATRA

62U	62UC	R62Z	R62UC	62R	62Z	62RS	63G	R63G	63H	R63H	H63G
—	—	—	—	—	—	—	—	—	—	—	—

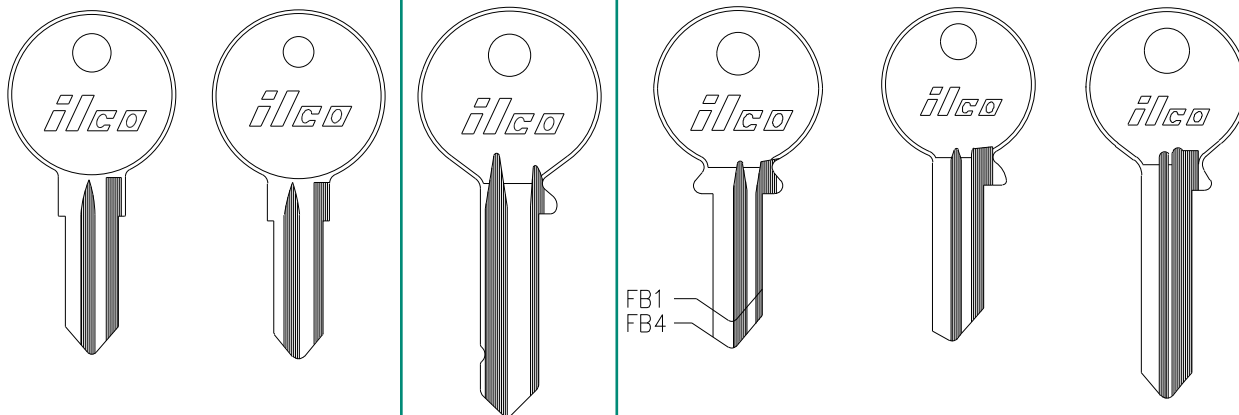
**ILCO
EZ**
SIMCA/TALBOT/MATRA
SIMPLES
SKODA

L63G	LR63G	N63G	62RS	FB1	FB4	FB5	FB6
—	—	—	—	—	—	—	—

**ILCO
EZ**

 FB1
FB4

SKODA

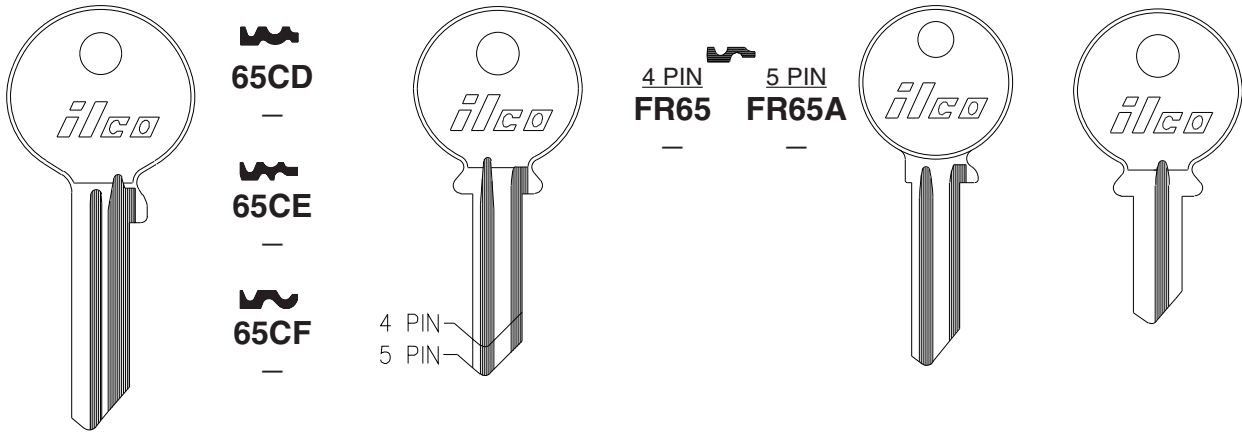

65CA	65CB	4 PIN F65	5 PIN F65A	F65L	FR65S	
-	-	-	-	-	-	

ILCO
EZ

SKODA

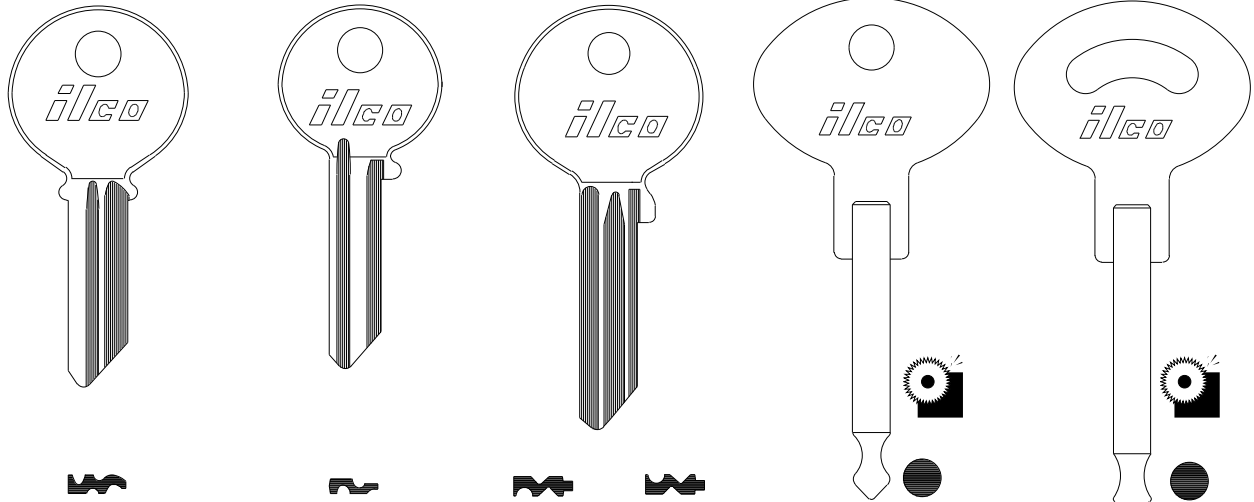

S65CA	UF65A	SK91E	SK91H	138	139
-	-	-	-	-	-

ILCO
EZ

SKODA SKODA MOTORBIKE STERLING

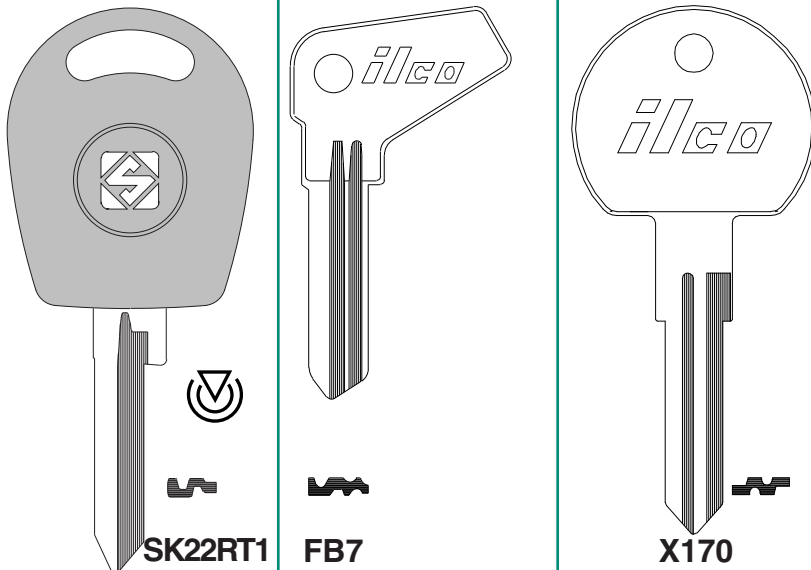

SK22RT1	FB7	X170 NE48
-	-	

ILCO
EZ

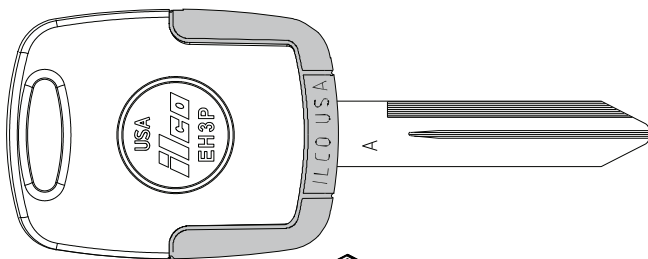
STERLING
STERLING TRUCK

EH3P
(Head Only)

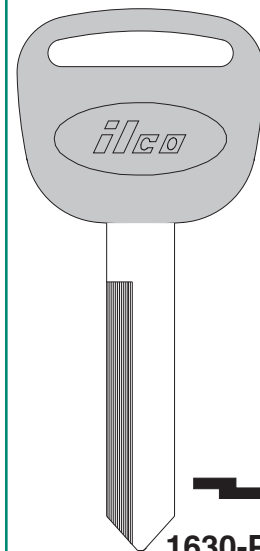
EB3-A-Y160
(Blade Only)

EK3P-Y164
(Complete Key)

1630-P
—

ILCO
EZ

sec 1 page 135

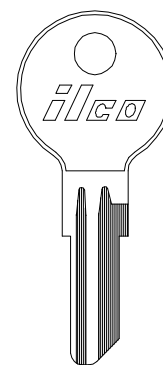
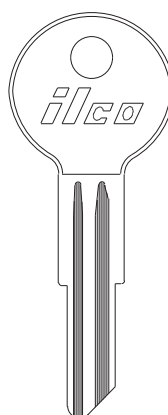
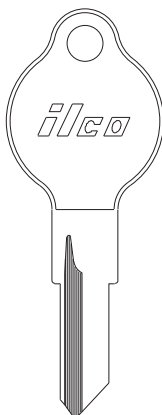
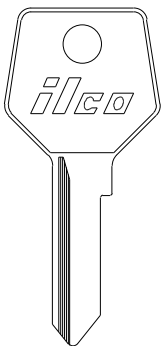
VEHICLE

STREBOR
STUDEBAKER

SR4
—

SR5
—

64SS
—

L1122A L1122AR
Y101 —

O1122A O1122AR
Y12 Y14

ILCO
EZ

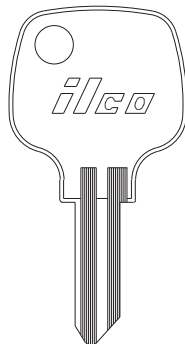
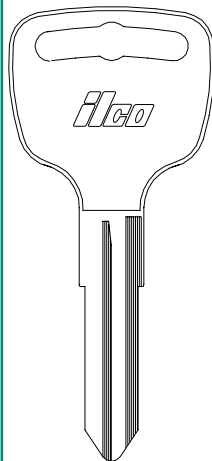
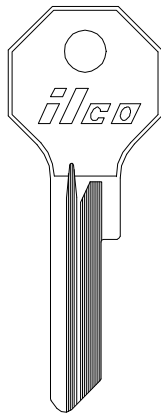
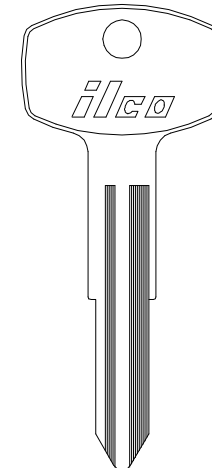
STUDEBAKER SUBARU

SJ4
—

SJ5
—

X1199AR
Y133

SJ1
—

SJ2 SJ3
— —

SJ6
—

X6
62DT

ILCO
EZ

SUBARU

VEHICLE

sec 1 page 136

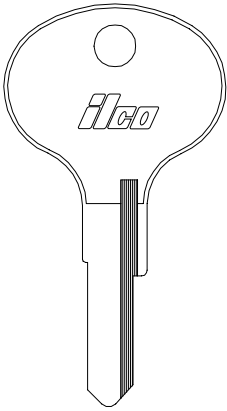

X108
SR6

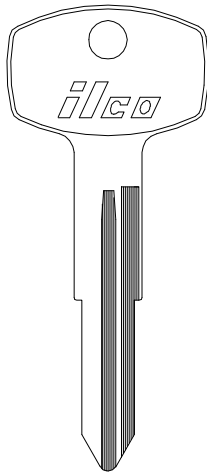

X115
DA23

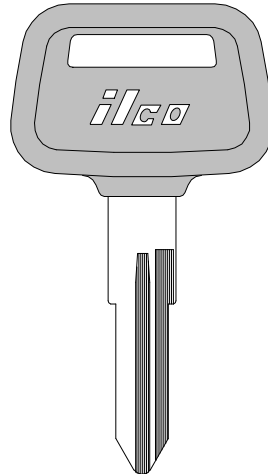

DA23-P
—

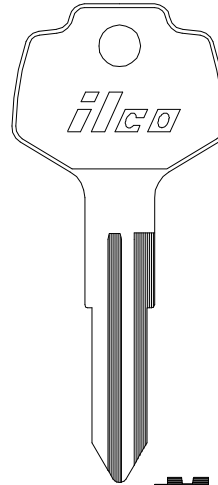

X123
DA25

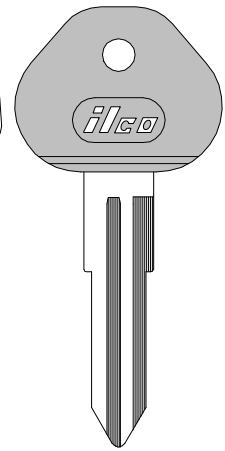

DA25-P (-PC)
—

ILCO
EZ

SUBARU

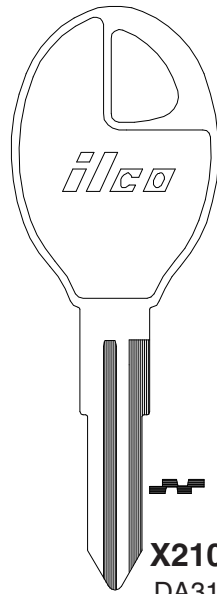

X210
DA31

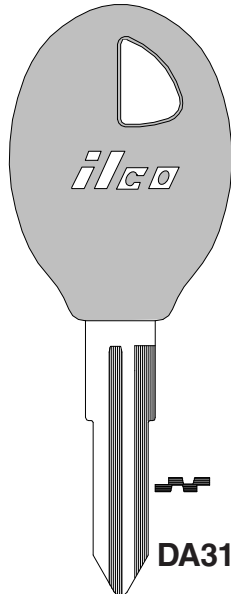

DA31-P (-PC)
—

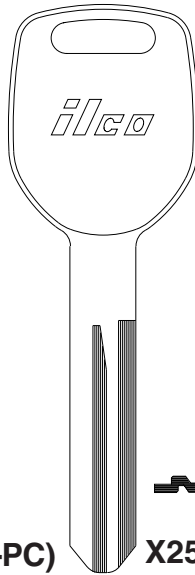

X251
SUB1

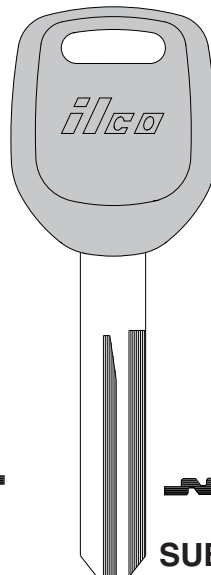

SUB1-P
—

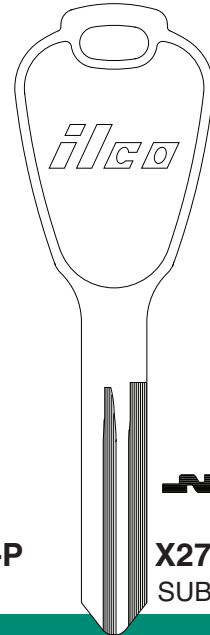

X271
SUB2

ILCO
EZ

SUBARU

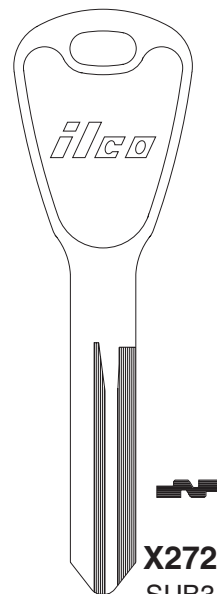

X272
SUB3

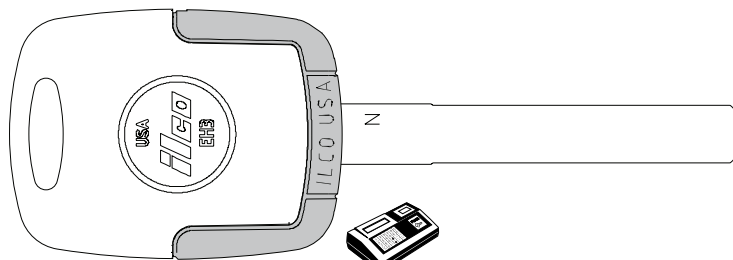



SUB1-EK3
(Complete Key)

EH3
(Head Only)

EB3-N-SUB1
(Blade Only)

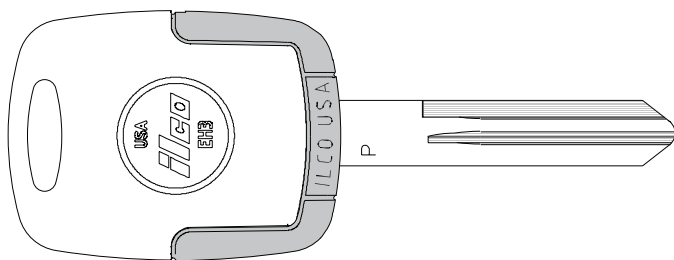
ILCO
EZ

SUBARU**EH3**
(Head Only)
EB3-P-SUB4
(Blade Only)**SUB4-EK3**
(Complete Key)ILCO
EZ

VEHICLE

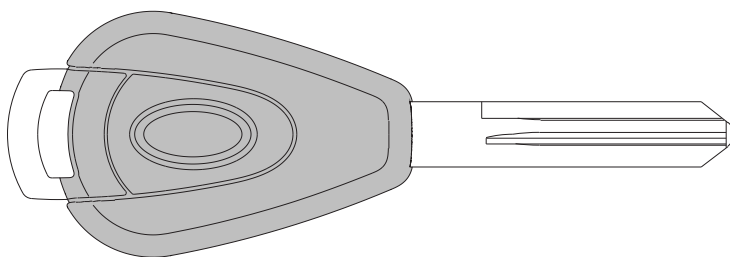
sec
1 page
137**SUBARU****SUB4-PT**

—

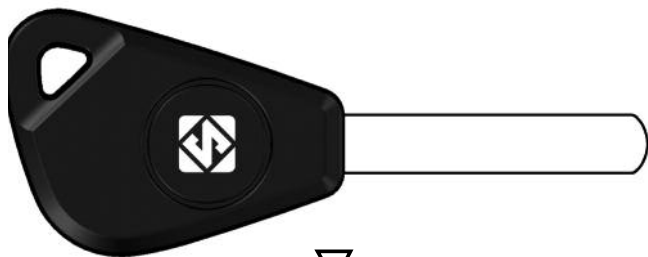
ILCO
EZ**SUBARU****SUNBEAM (See Rootes Group also)****DAT17T13**

—

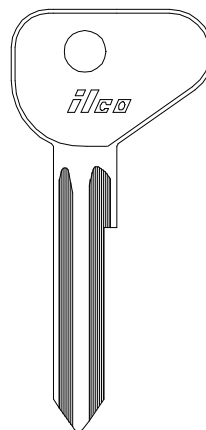
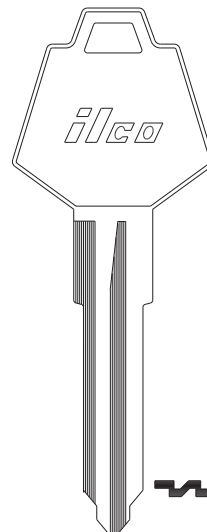
ILCO
EZ**X1**
MZ12**X16**
P1771CR

SUNBEAM

SUZUKI AUTOMOBILES

VEHICLE

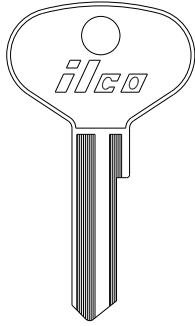

HR62DG

—

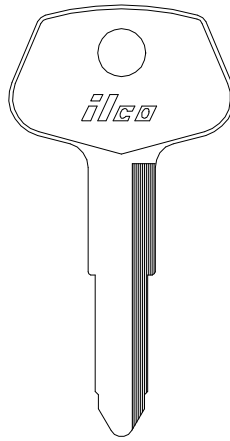

X54

DC1

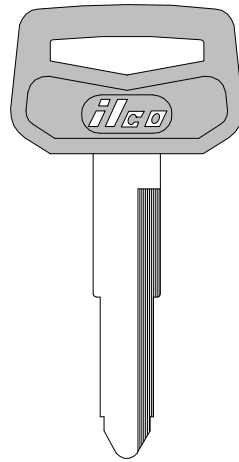

DC1-P

—

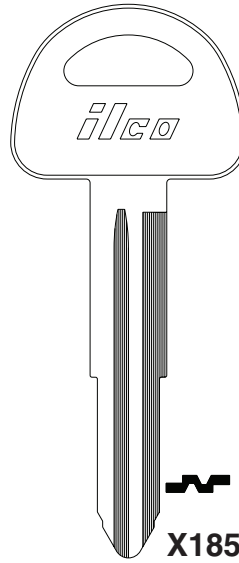

X185

SUZ15

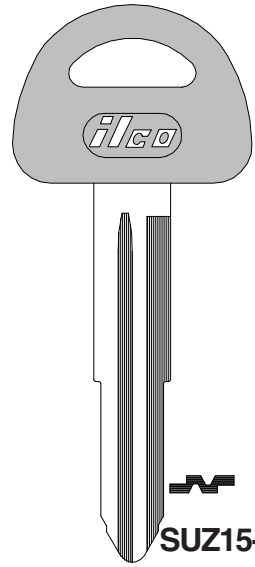

SUZ15-P

—

ILCO
EZ

SUZUKI AUTOMOBILES

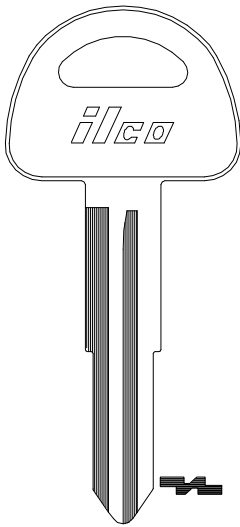

X186

SUZ17

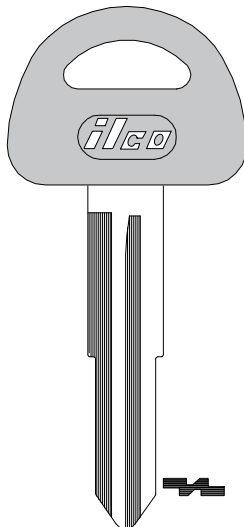

SUZ17-P

—

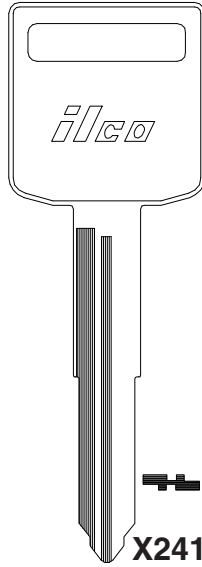

X241

SUZ18

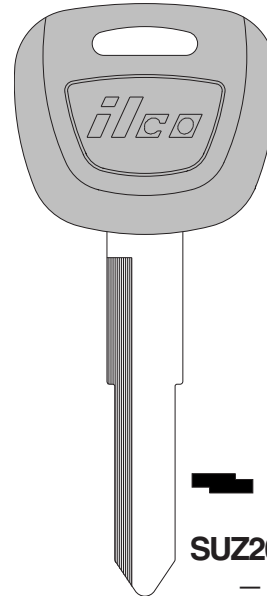

SUZ20-P

—

ILCO
EZ

SUZUKI AUTOMOBILES

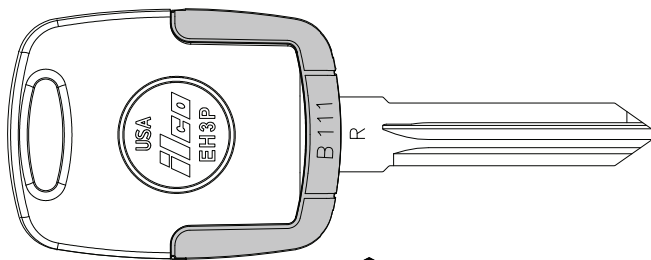

EH3P

(Head Only)



EB3-R-B111

(Blade Only)



EK3P-B111

(Complete Key)

ILCO
EZ

SUZUKI MOTORCYCLES

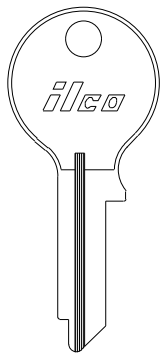

SUZ2
—

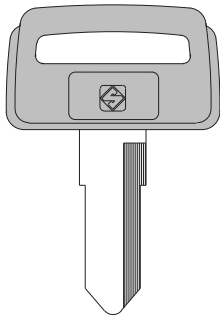

SZ4P
—

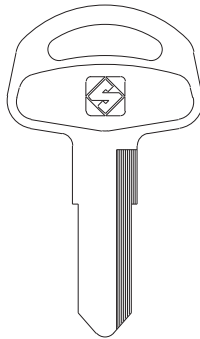

SZ4R
—

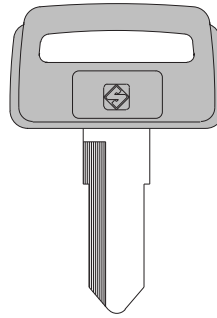

SZ4RP
—

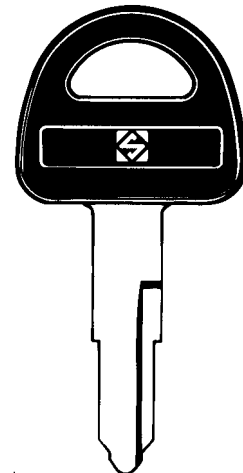

SZ5P
—

SUZ3
—

SUZ4
—



SUZ1
—

ILCO
EZ

SUZUKI MOTORCYCLES

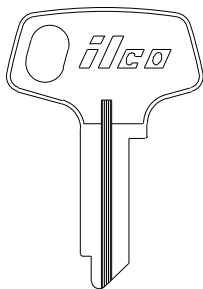

SUZ8
—

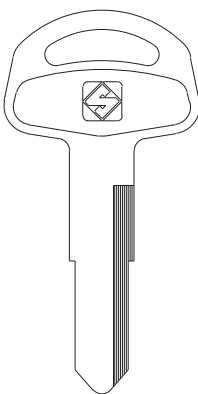

SZ9
—

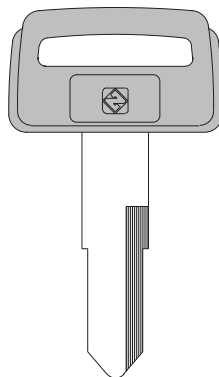

SZ9P
—

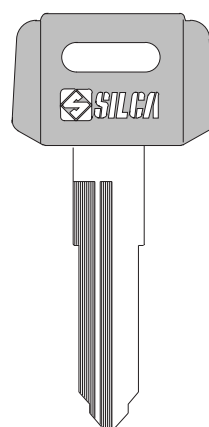

SZ10RP
—

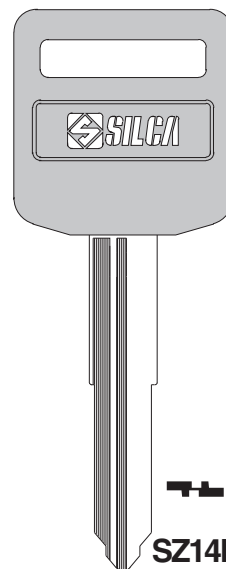

SZ14RAP
—

SUZ9
—



SUZ6
—



SUZ7
—

ILCO
EZ

SUZUKI MOTORCYCLES

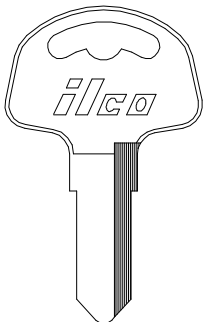

SUZ10
—

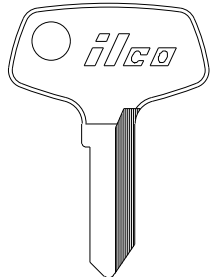

X11
SUZ5

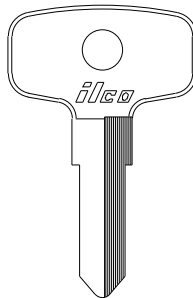

X25
—

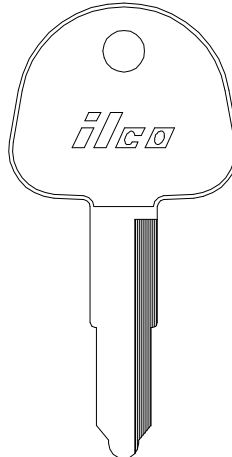

X87
SUZ11

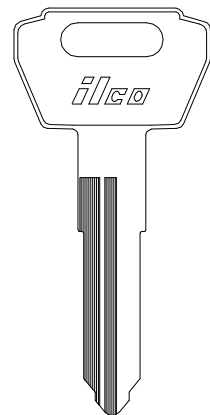

X179
SUZ12

ILCO
EZ

SUZUKI MOTORCYCLES

VEHICLE

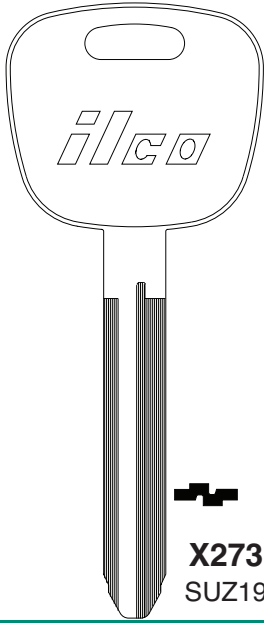

X273
SUZ19

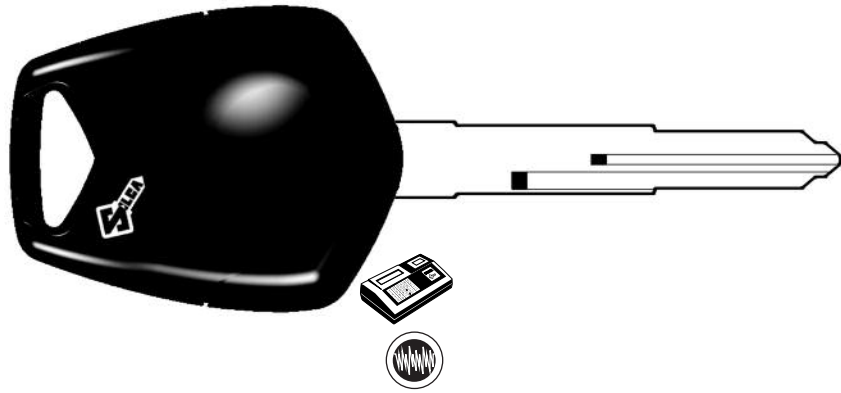

SZ17REH2
—

ILCO
EZ

sec 1 page 140

SUZUKI MOTORCYCLES

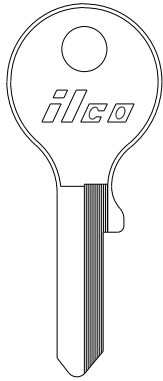

N2M
SR61N

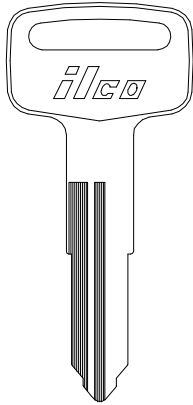

X117
YH48

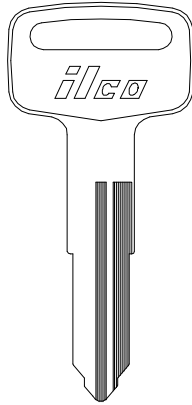

X118
YH49

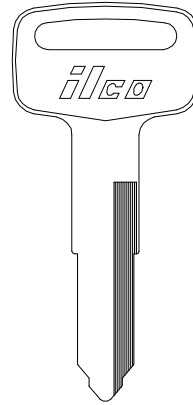

X119
YH47

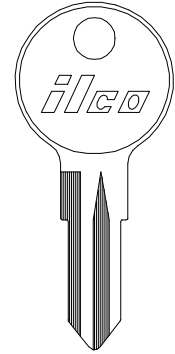

X226
HYD12

ILCO
EZ

SUZUKI MOTORCYCLES

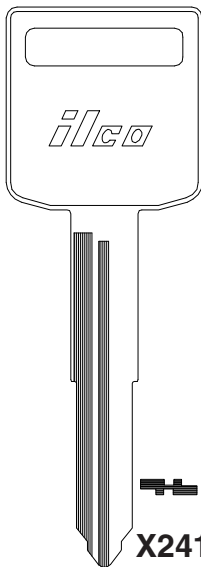

X241
SUZ18

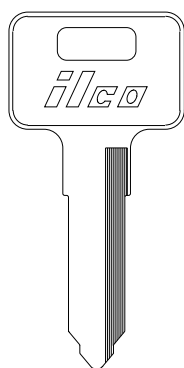

X259
KW14

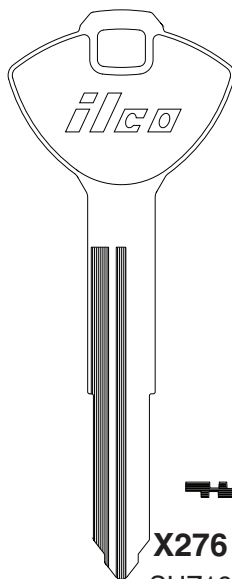

X276
SUZ16

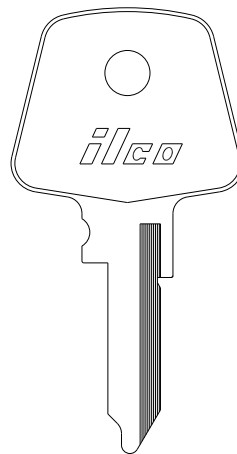

Y16
—

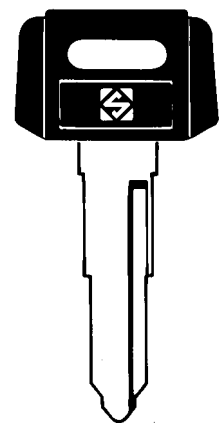

YH29P-SI
—

ILCO
EZ

SUZUKI MOTORCYCLES

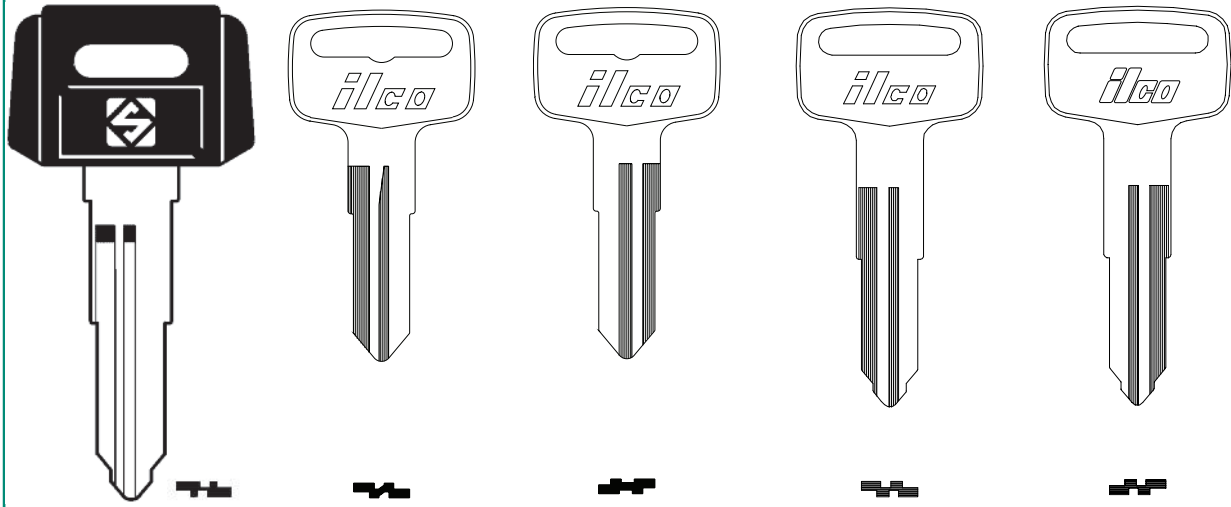

ILCO
EZ

YH29RP-SI

YH34

YH35

YH50

YH51

SUZUKI MOTORCYCLES

SWEDISH CAMP CAR

TAUNUA

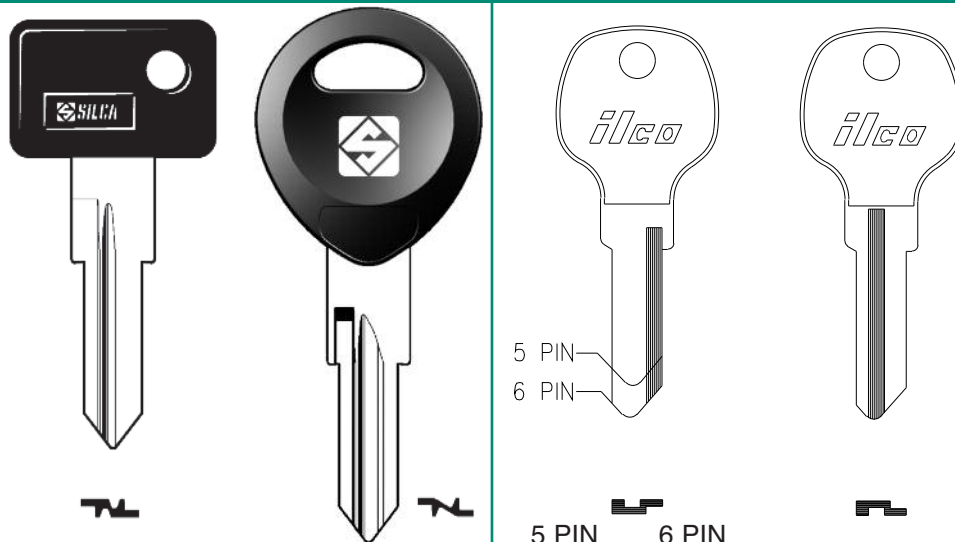

ILCO
EZ

ZD16RP-SI

ZD24RDP-SI

5 PIN
GH3

6 PIN
GH1

GH2

SEE
FORD
INTERNATIONAL

TEMPO

TITAN



ILCO
EZ

FV1
FV1

NE7

62VA

62VH

63L

TT1

TITAN	TOOL BOX					
TT91	1527	1529	1536	1536R	1557	1565
-	-	-	-	-	-	-

ILCO
EZ

TOOL BOX		TOYOTA			
1605	1620	TA1	TA14	TP1	TP4
-	-	-	-	-	-

ILCO
EZ

TOYOTA							
TA2	TA11	TA16	TA6	TA7	TA8	TA9	TA15
-	-	-	-	-	-	-	-

ILCO
EZ

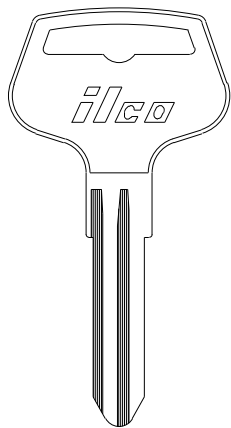
TOYOTA

TA19
—

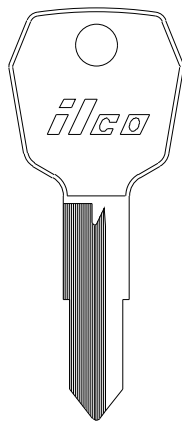

TA23
—

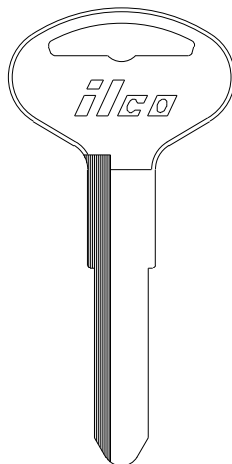

TA24
—

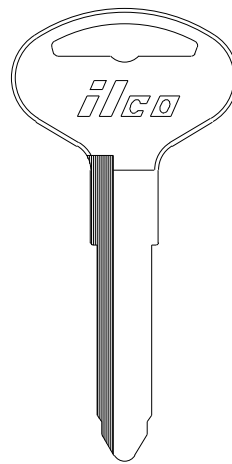

TA25
—

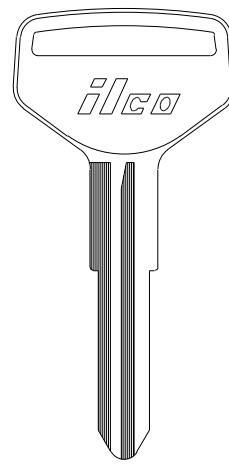

TR25
—

ILCO
EZ

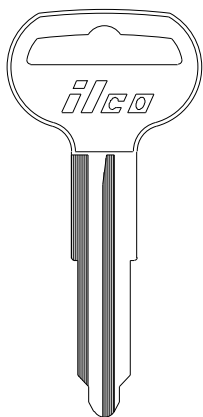
TOYOTA

TA26
—

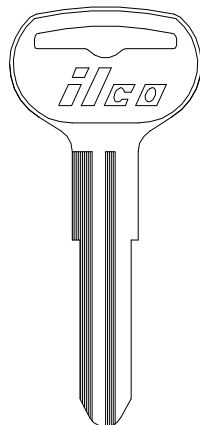

TR26
—

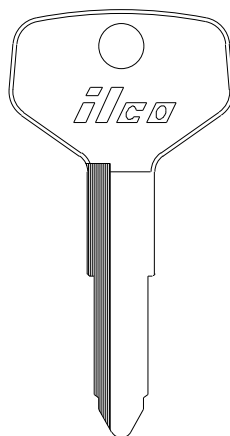

TA28
—

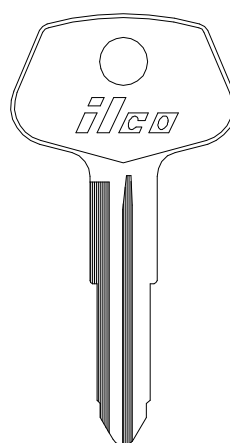

X37
TR28

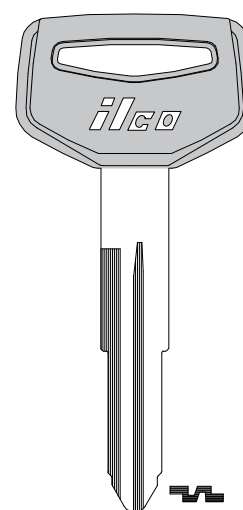

TR28-P
—

ILCO
EZ

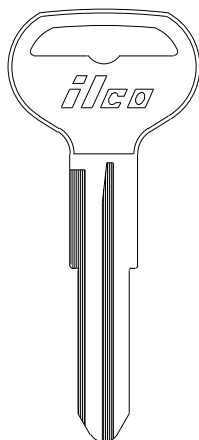
TOYOTA

X46
TA27

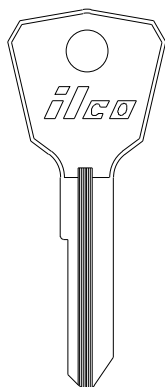

T61A

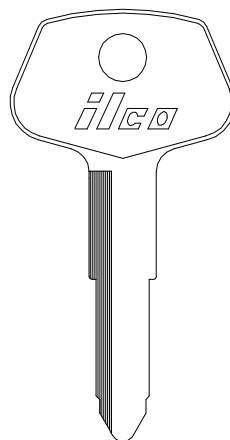

T61C
—

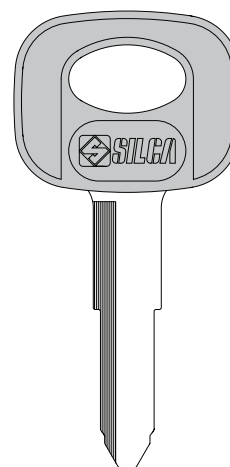

T61C-P
—

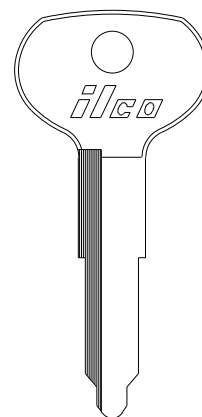

T61D
—

ILCO
EZ

TOYOTA

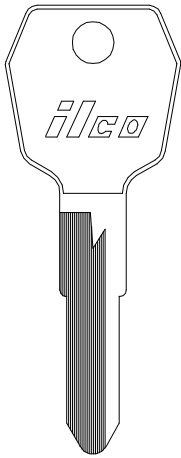

T61F

—

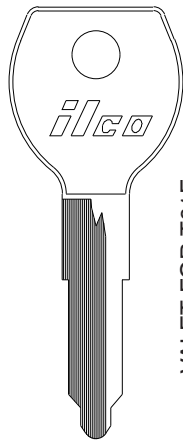

T61E

—

VALET FOR T61F

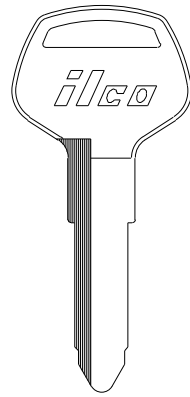

T61G

—

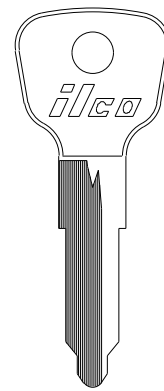

T80J

—

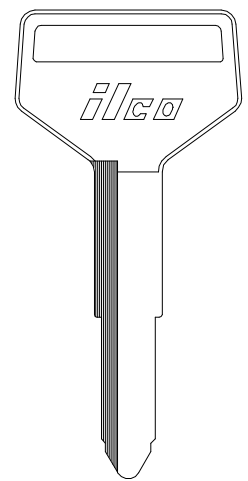

X137

TR33

—

ILCO
EZ

TOYOTA

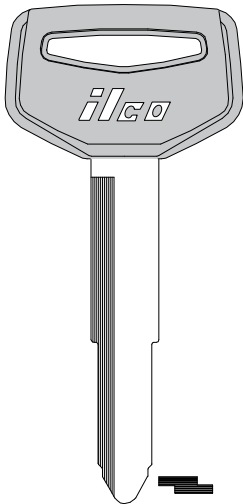

TR33-P (-PC)

—

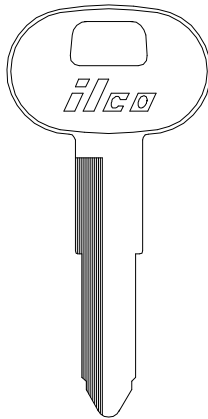

X146

B56

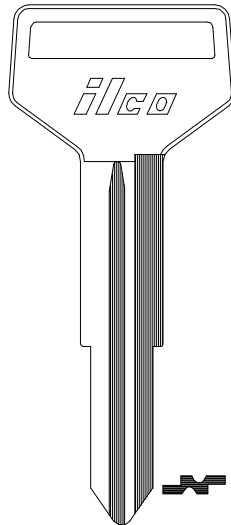

X151

TR39

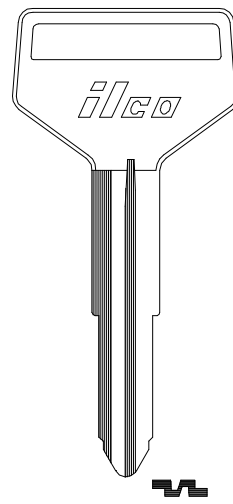

X159

TR37

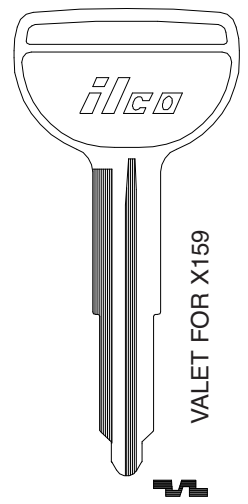

X218

TR49

VALET FOR X159

ILCO
EZ

TOYOTA

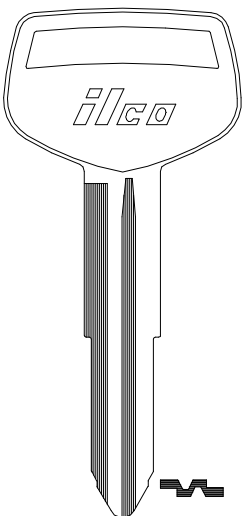

X174

TR40

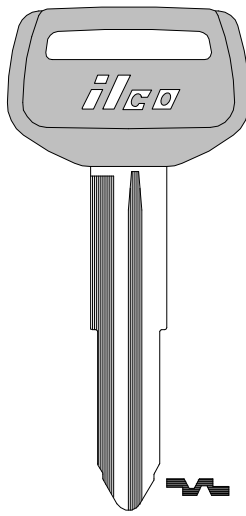

TR40-P (-PC)

—

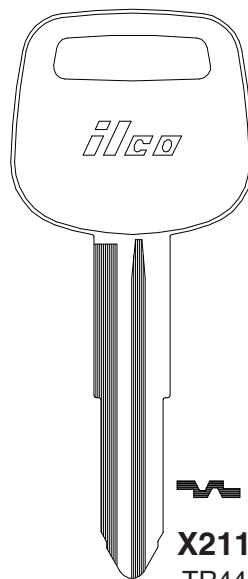

X211

TR44

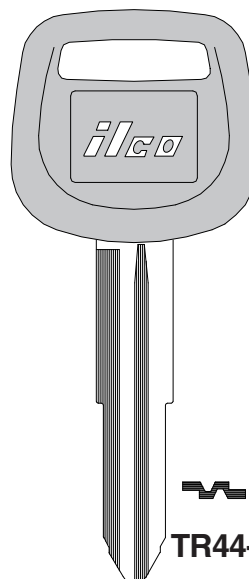

TR44-P

—

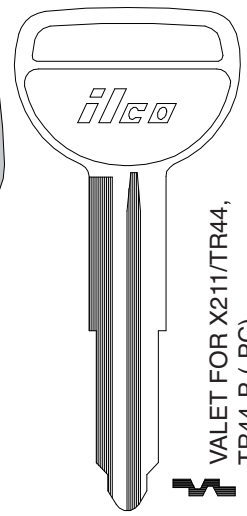

X219

TR48

VALET FOR X211/TR44,
TR44-P (-PC)

ILCO
EZ

TOYOTA

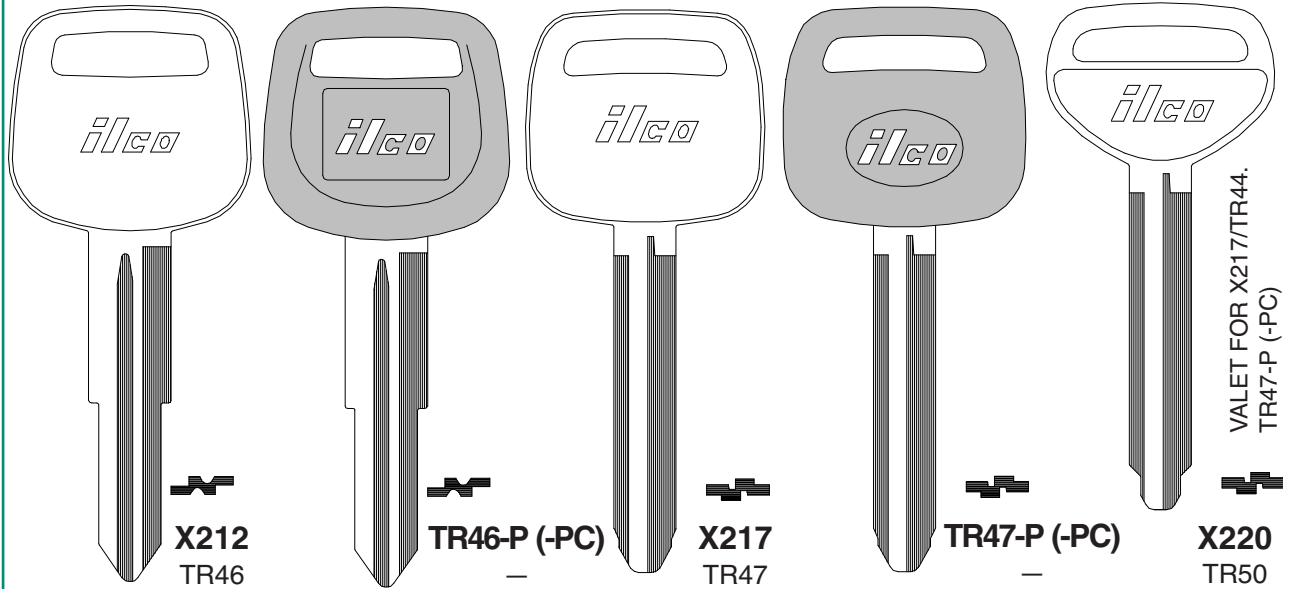

TOYOTA

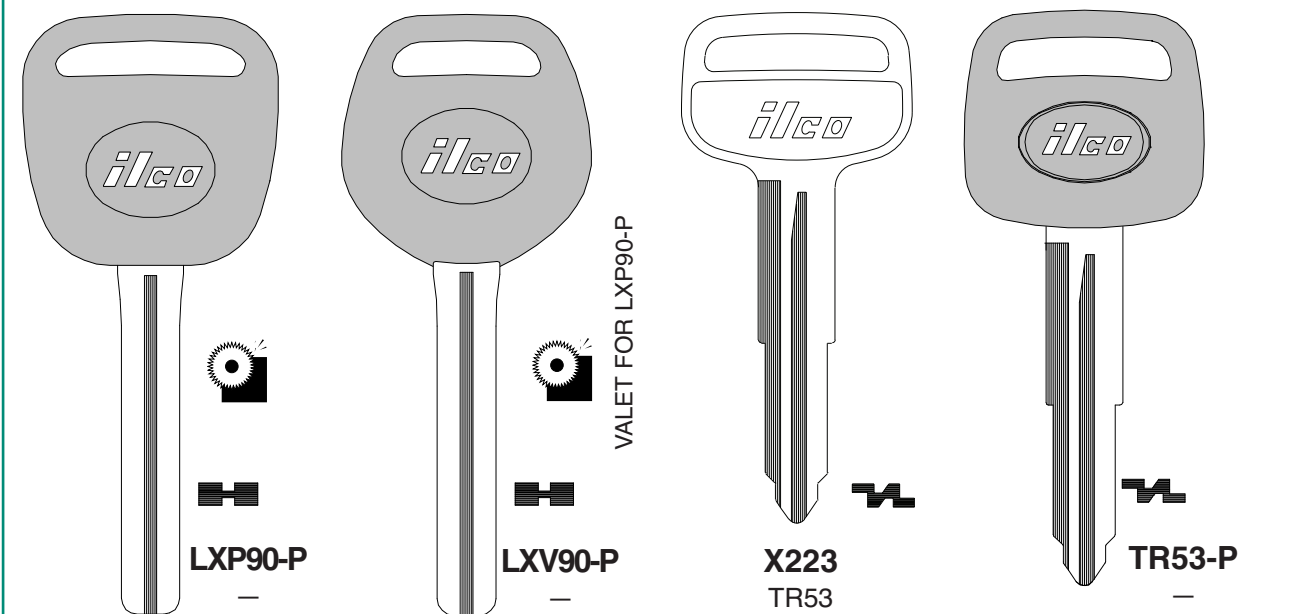

TOYOTA

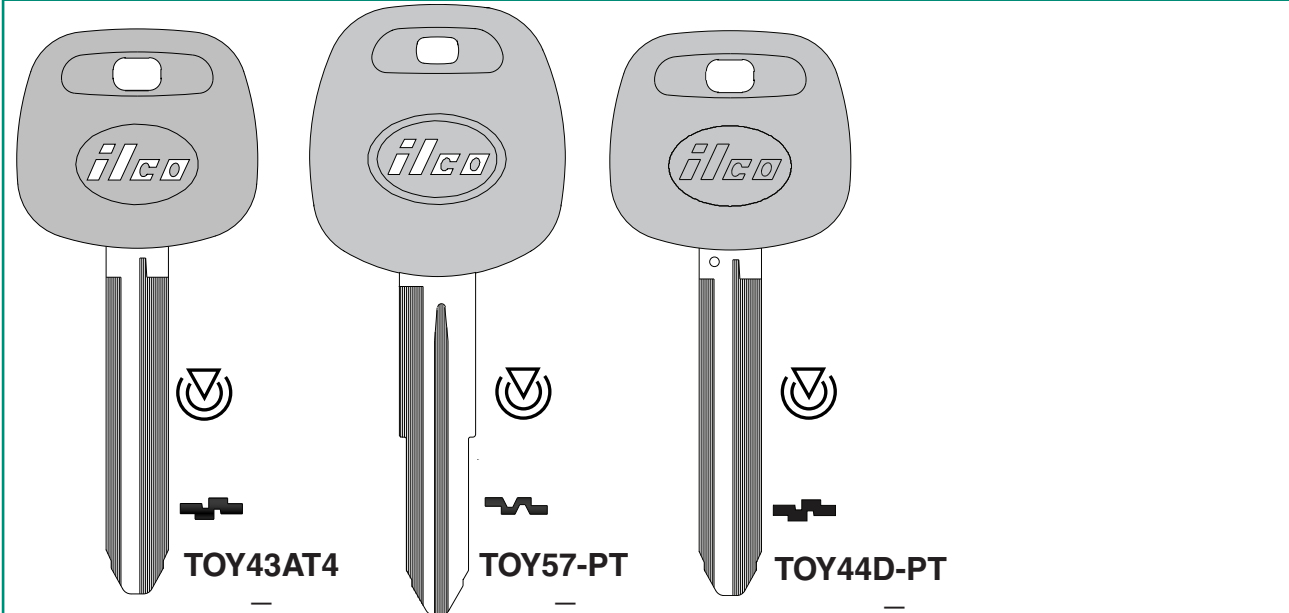

TOYOTA

TRABANT

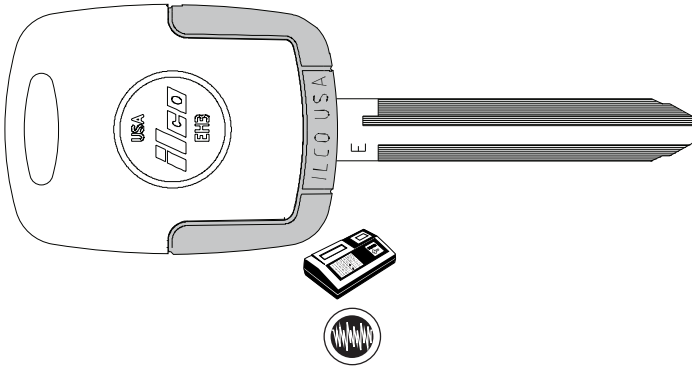

EH3
(Head Only)

EB3-E-TOY43
(Blade Only)

TOY43-EK3
(Complete Key)

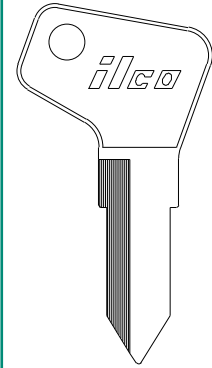

 
DB1 **DB2**
— —

ILCO
EZ

TRIUMPH

TRIUMPH MOTORCYCLE

**SEE
BRITISH
LEYLAND**

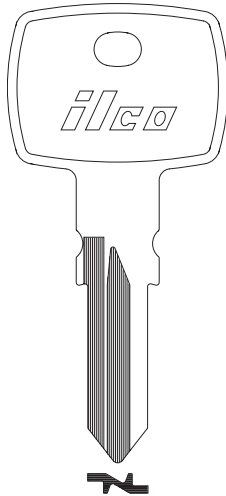

X270
TMC1

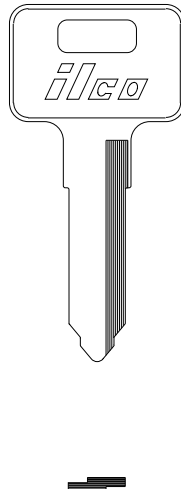

X259
KW14

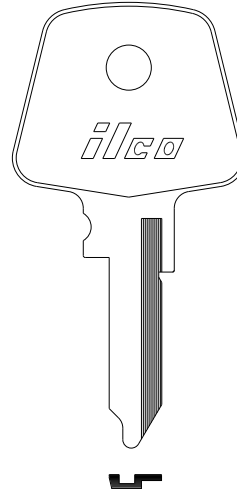

Y16
—

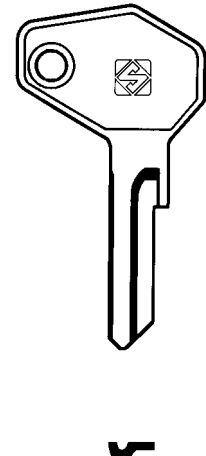

ZD7-SI
—

ILCO
EZ

TRIUMPH MOTORCYCLE

VAN GUARD

VAUXHALL



ZD24RDP-SI
—

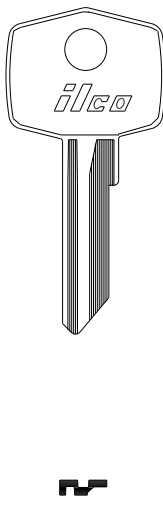

62FS
—

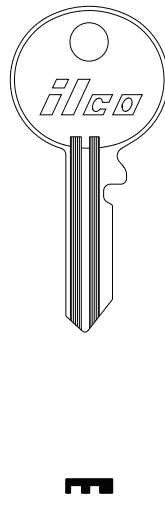

R62DM
—

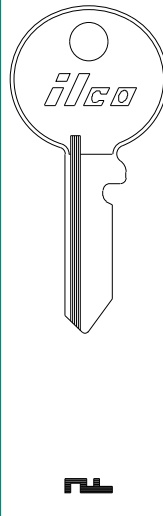

62DP
—

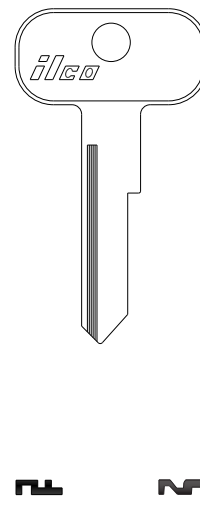

H62DP **H62DR**
— —

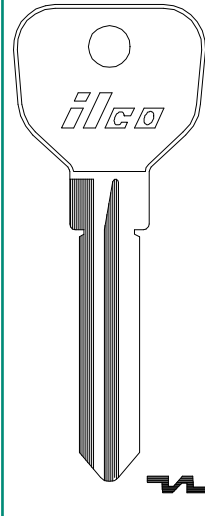

MG1
—

ILCO
EZ

VAUXHALL

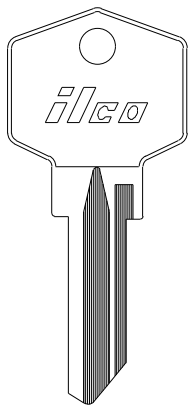

UN1

—

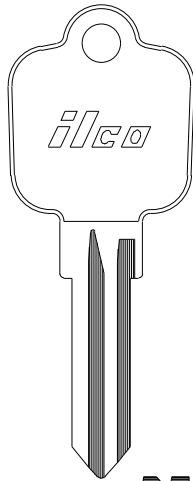

CE2

—

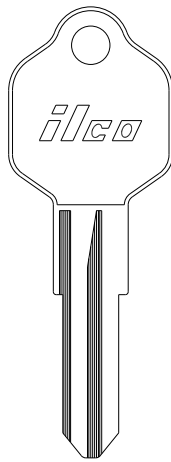

CE3

—

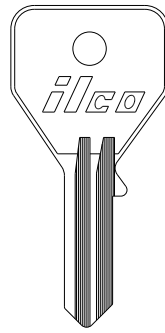

BR5

—

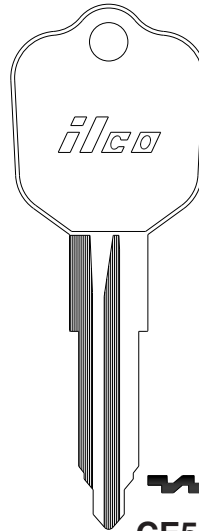

CE5

—

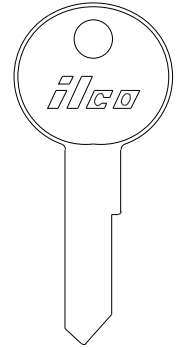

LF5

—

ILCO
EZ

VAUXHALL

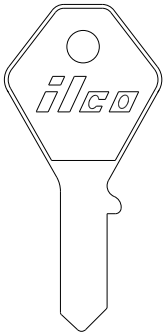

BR7

—

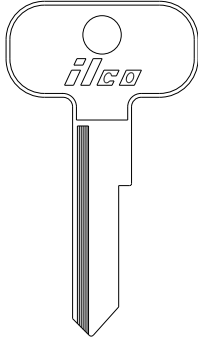

BR9

—

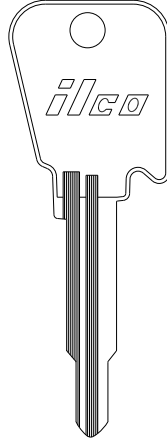

X13

LF4

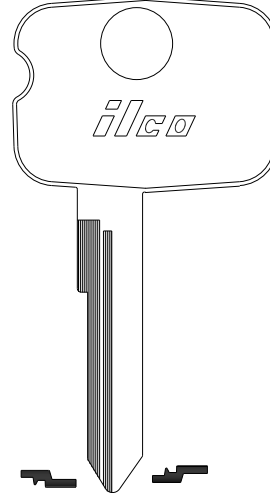

YM29

—

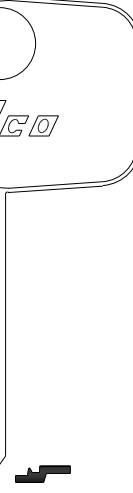

YM30

—

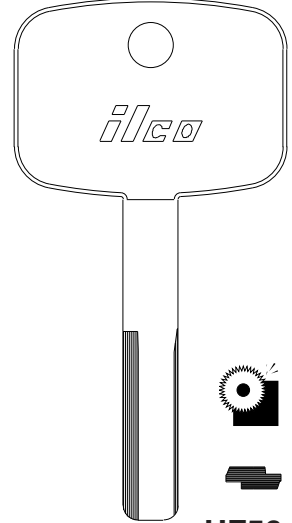

HF56

—

ILCO
EZ

VAUXHALL

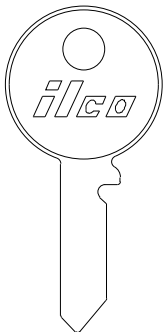

62DG

—

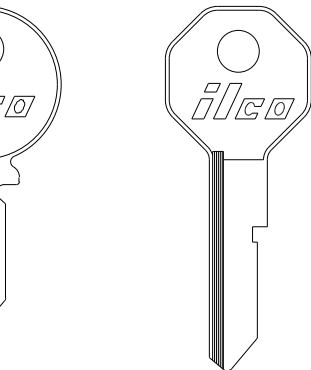

62DP

—

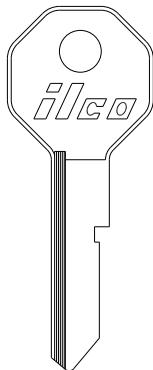

62DN

—

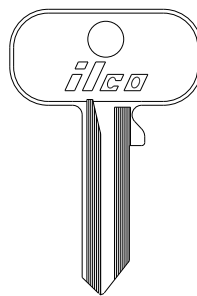

B62DR

—

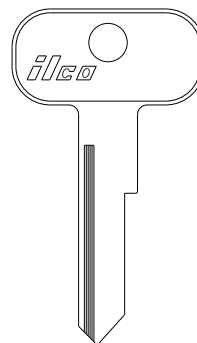

H62DP

—



H62DR

—



64K

—

ILCO
EZ

VESPER

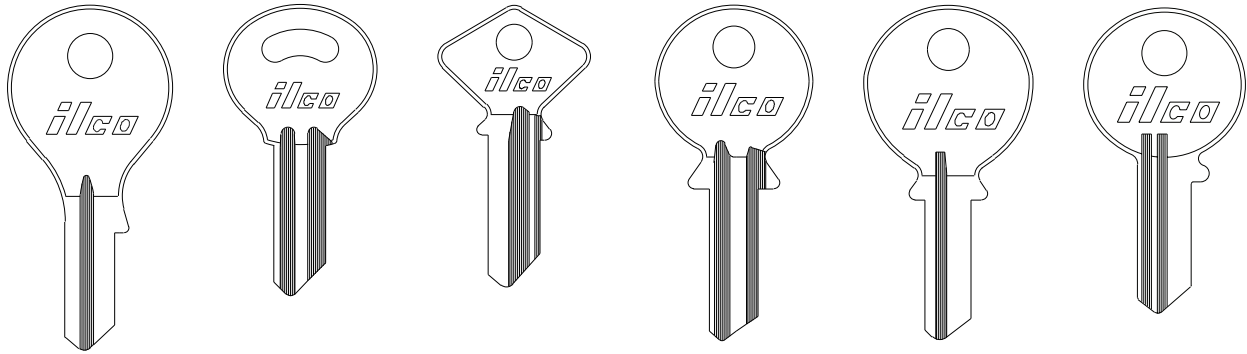

									ILCO
DO1S	VS1	VS3	VE4	VE5	VE6	V61S	VR61S	EZ	
-	-	-	-	-	-	-	-		

VESPER

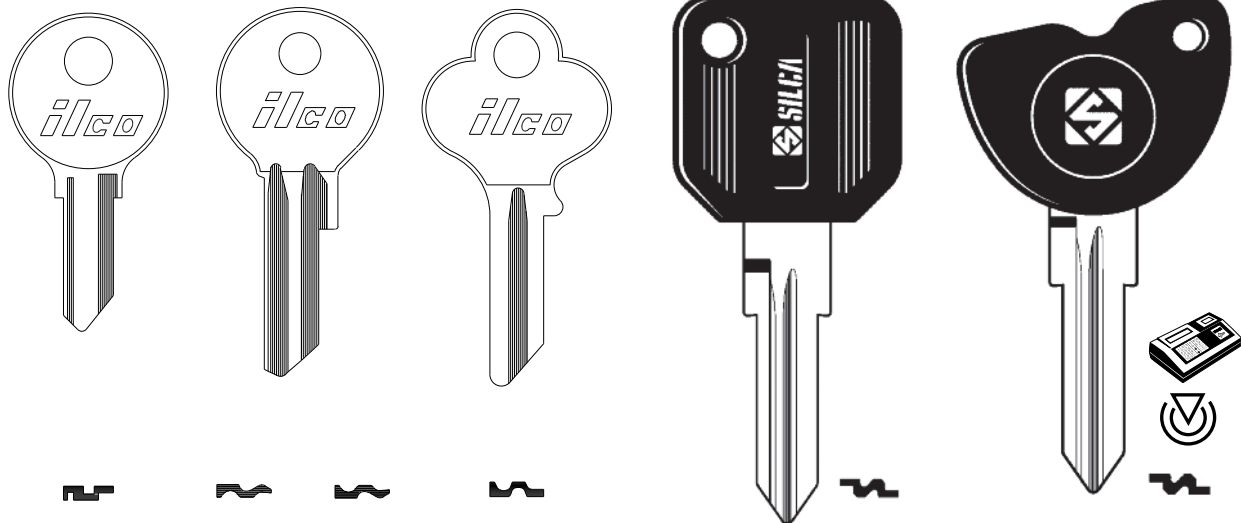

							ILCO
62VA	63V	R63V	FV1	GTI5RAP-SI	GTI5RDT5-SI		EZ
-	-	-	-	-	-		

VESPER VICTORY VIKING

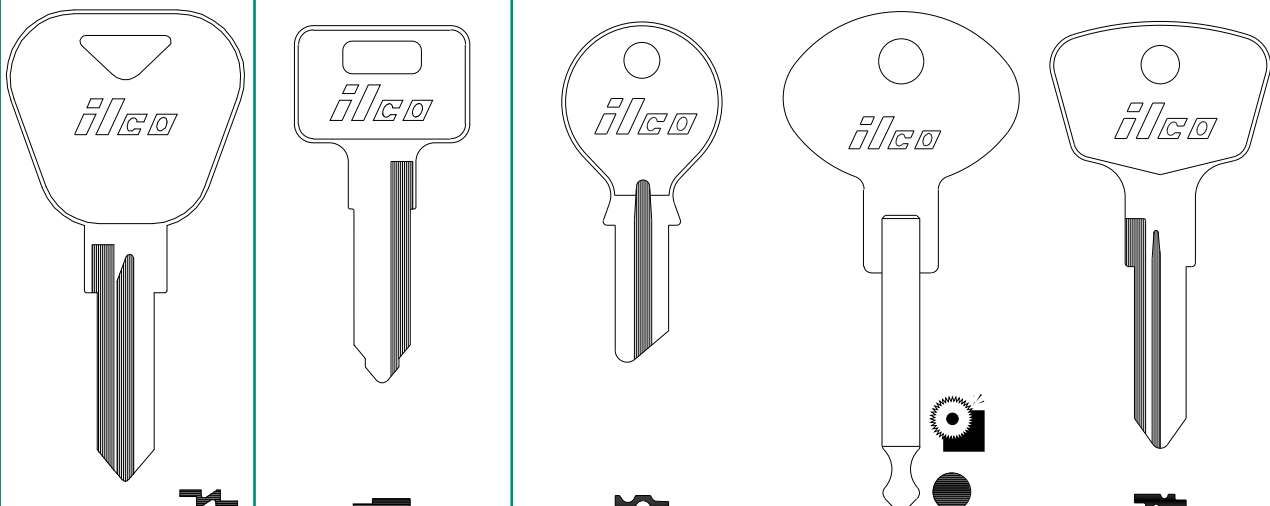

					ILCO
X167	X259	63	138	AD1	EZ
YU2	KW14	-	-	-	

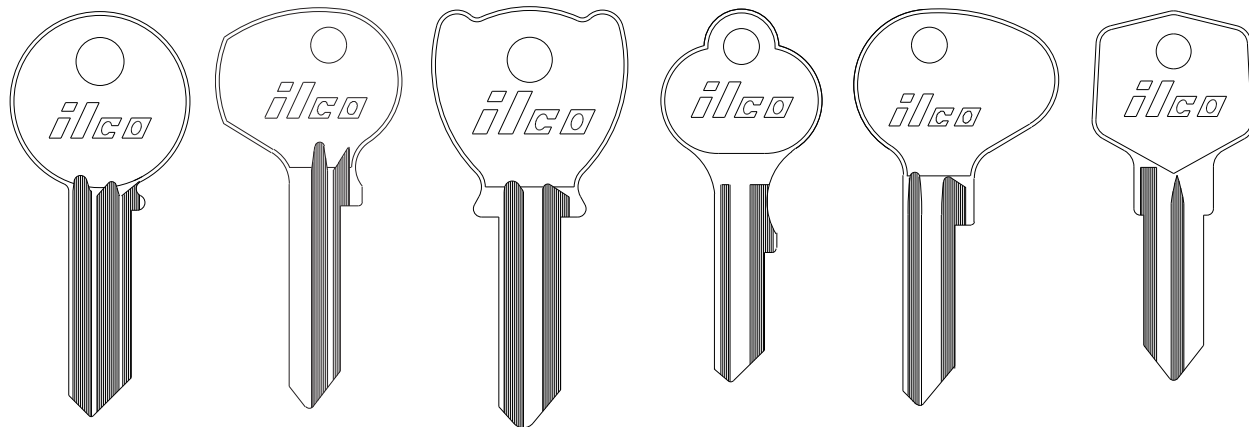
VOLKSWAGEN

BKZ1

—

KP1

—

BT2

—

VW1

—

VW1CZ

—

CA2

—

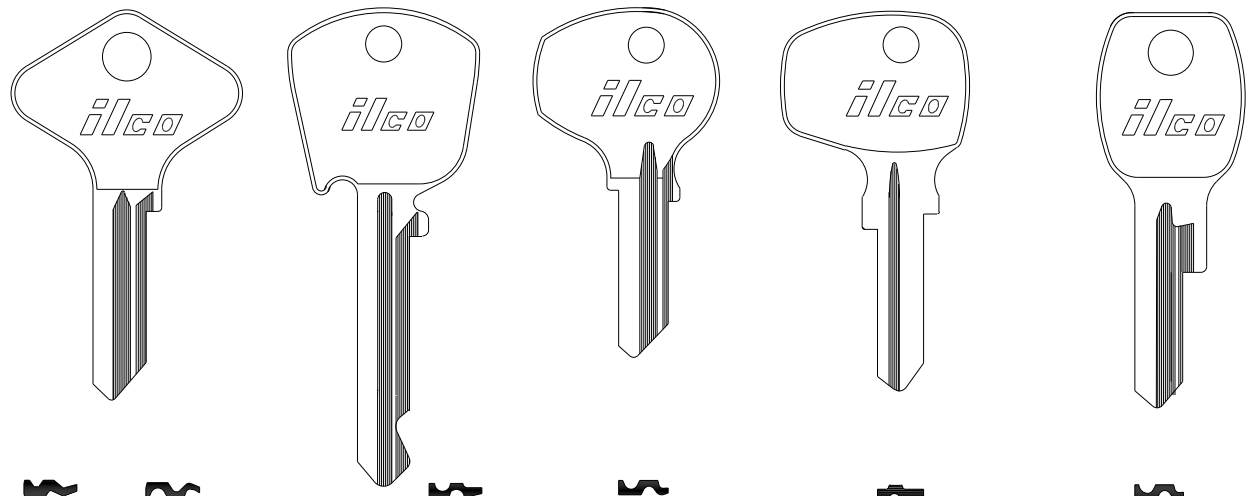
**ILCO
EZ**
VOLKSWAGEN

DM2

—

DM3

—

FT3

—

DM4

—

MB5

—

WS5

—

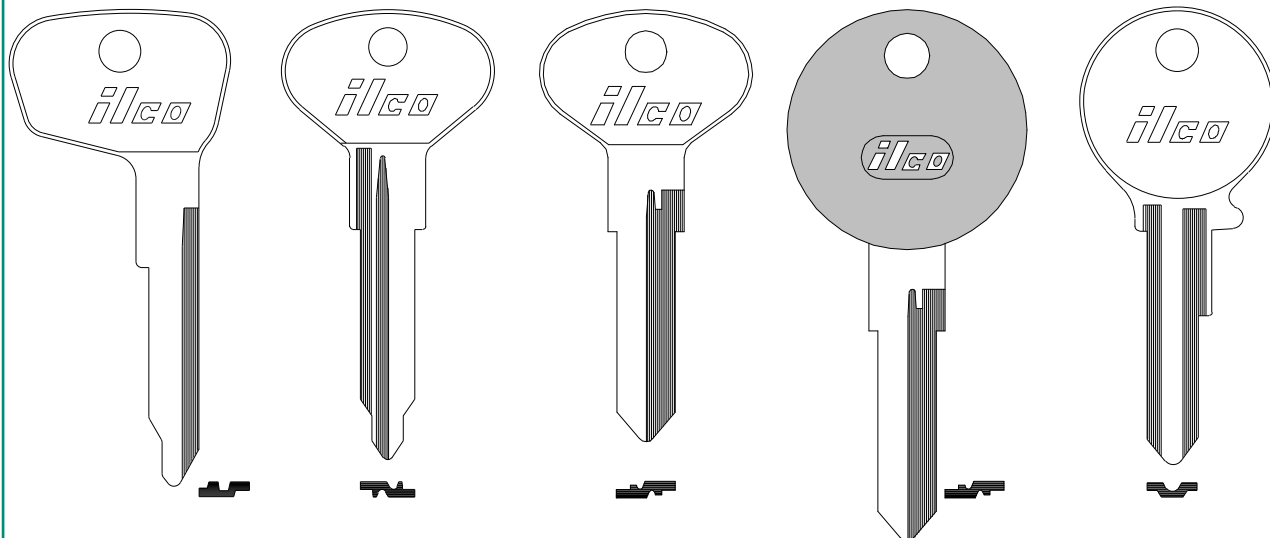
**ILCO
EZ**
VOLKSWAGEN

WT5

—

X8

VW20

X9

73VB

73VB-P

—

HF17

—

**ILCO
EZ**

VOLKSWAGEN

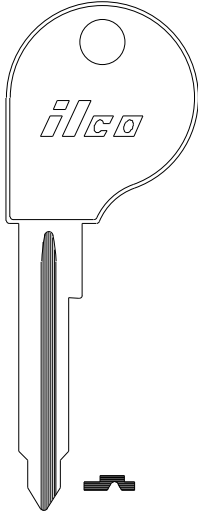

HF35
—

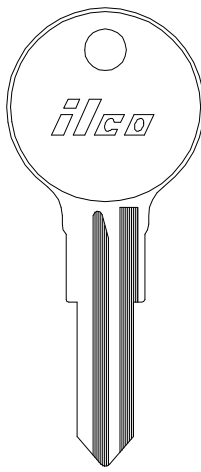

X53
V32

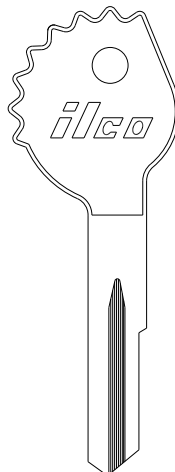

OP60C
—



61N
—



61NC
—

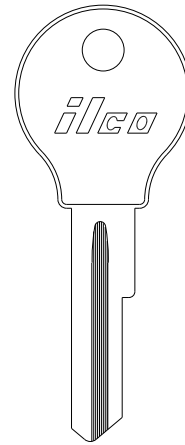

61VW
—



U61VW
—



V61VW
—

ILCO
EZ

VOLKSWAGEN

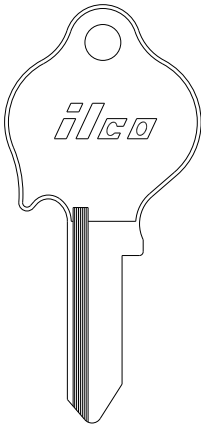

H61VM
—

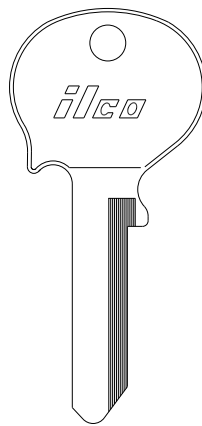

H61VR
—

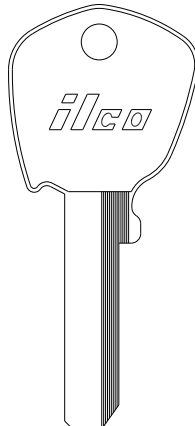

FT12R
—

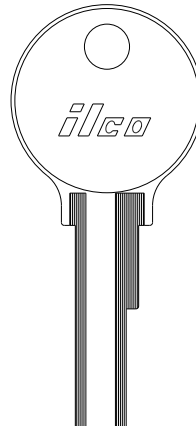

T61VR
—



62DW
—

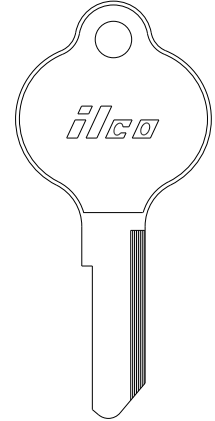

62VC
—

62VE
—

ILCO
EZ

VOLKSWAGEN



62VG
—

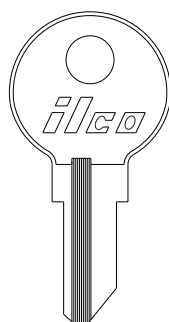

62VO
—

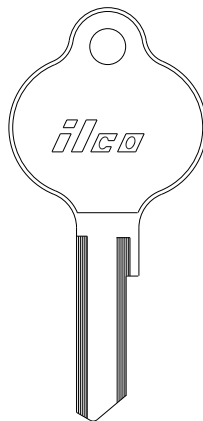

62VW
—

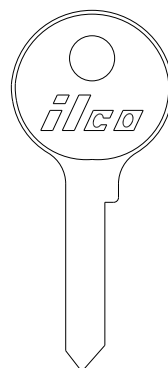

A62VC
—

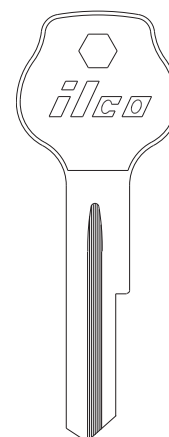

A62VN
—



HR62VK
—



L62VB
—

ILCO
EZ

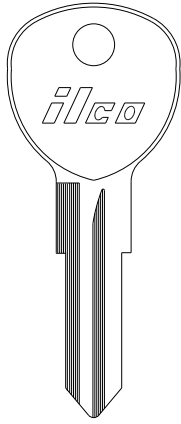
VOLKSWAGEN

H62FD

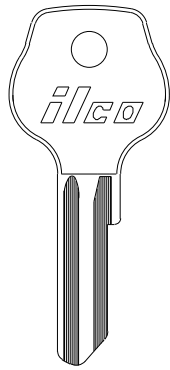
—

HR62FD

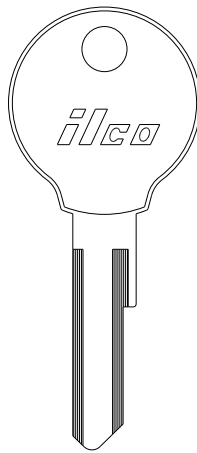
—

R62VN

—

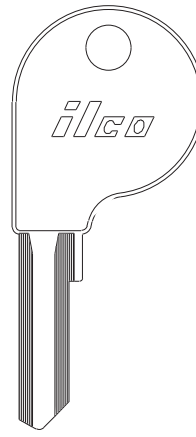
S62DW

—

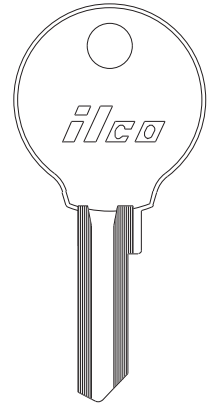
U62VB

—

U62VN

—

W62VB

—

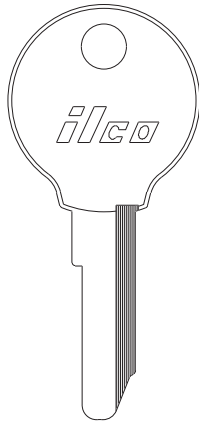
**ILCO
EZ**
VOLKSWAGEN

W62VE

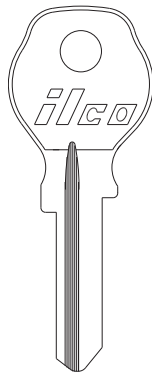
—

M63BG

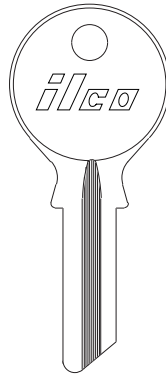
—

63L

—

A63L

—

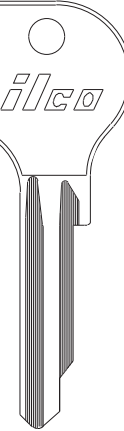
63VN

—

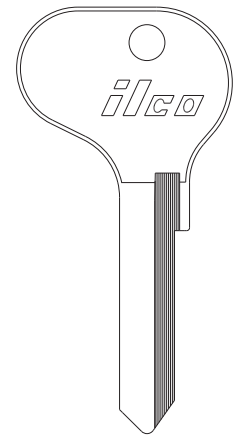
63VR

—

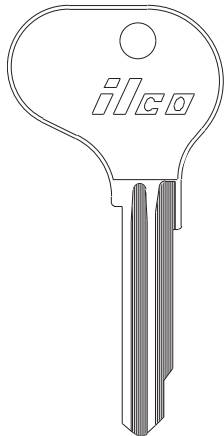
**ILCO
EZ**
VOLKSWAGEN

63VS

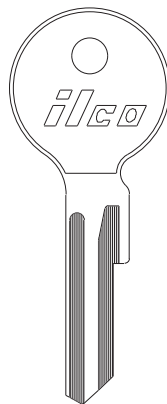
—

R63VS

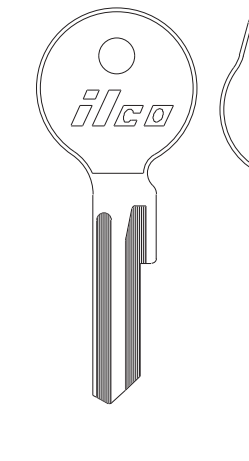
—

63WG

—

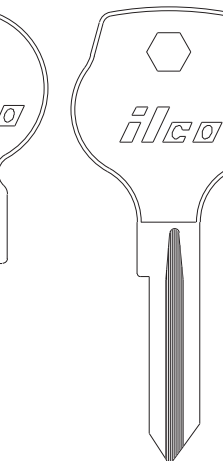
R63WG

—

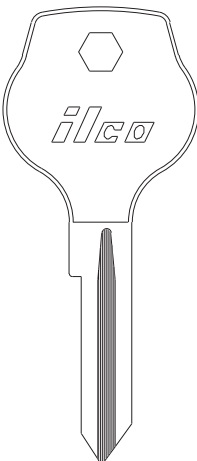
H63VO

—

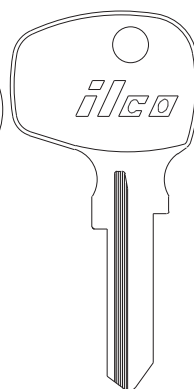
S63B

—

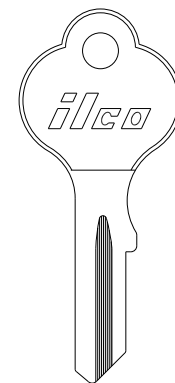
U63H

—

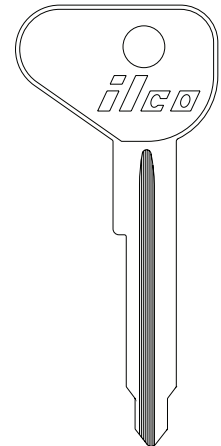
V27

V78JK

**ILCO
EZ**

VOLKSWAGEN

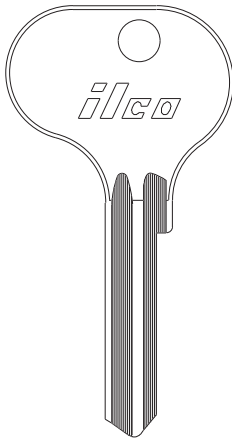

VW64
—

V72N
—



VW63
—

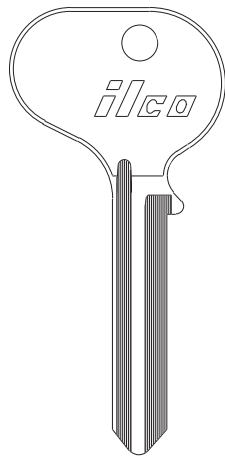

VW63A
—

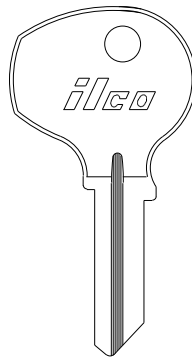

64K
—

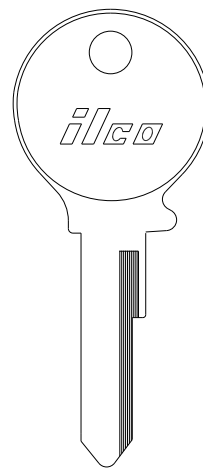

VW64T
—

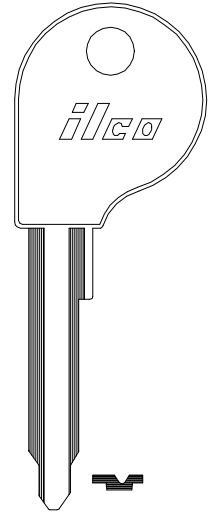

VW67
—

ILCO
EZ

VOLKSWAGEN

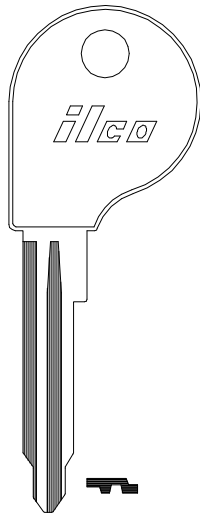

VW67S
—

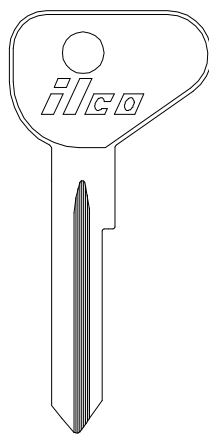

VW71



VW71A
—

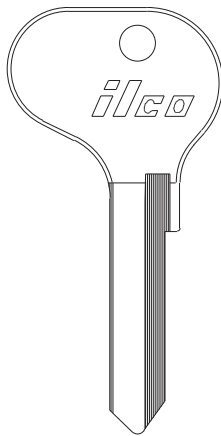

V72E
—

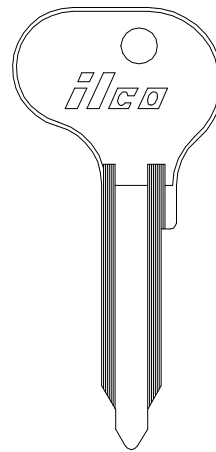

VW77
—

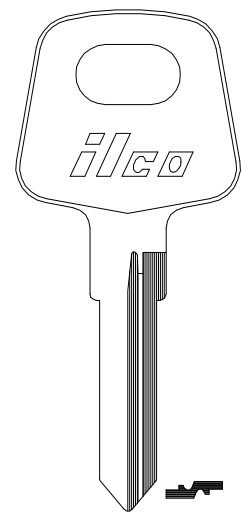

X88
PA8

ILCO
EZ

VOLKSWAGEN

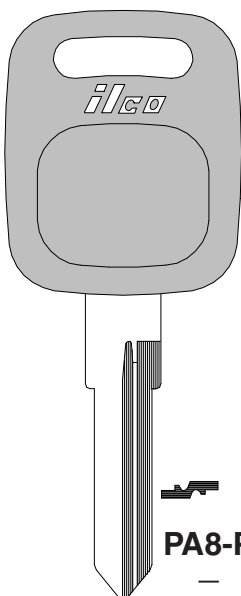

PA8-P
—

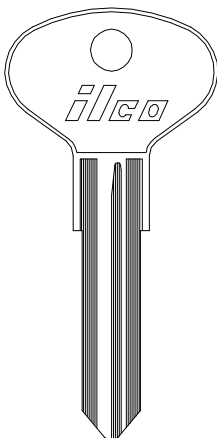

X110
V33

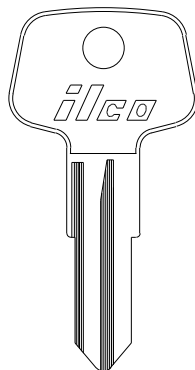

X132
—

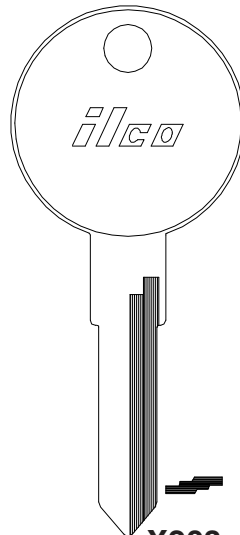

X203
V37

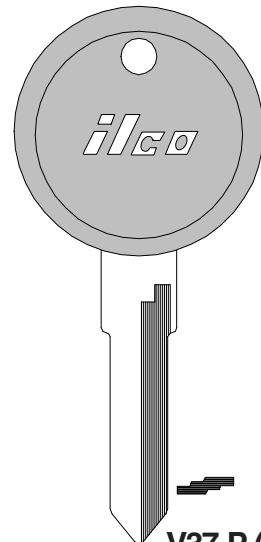

V37-P (-PC)
—

ILCO
EZ

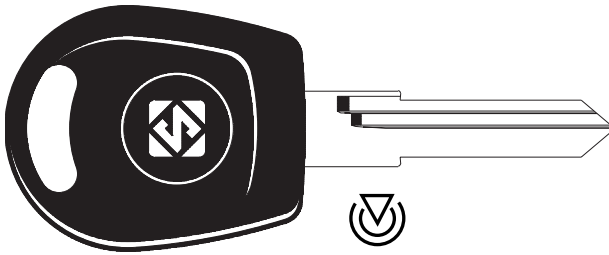
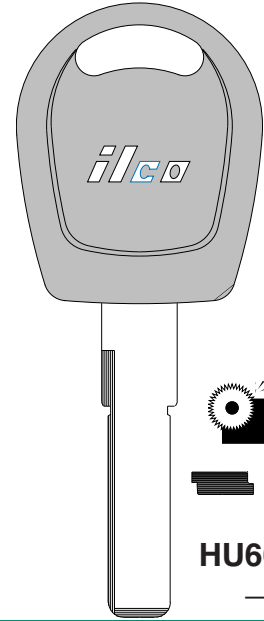
VOLKSWAGEN

HU49T1
—

HU66-P
—

ILCO
EZ

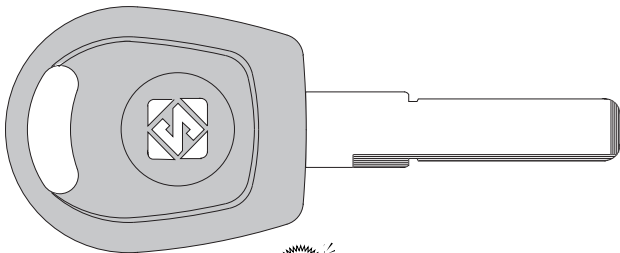
sec 1 page 153

VEHICLE

VOLKSWAGEN
VOLVO

HU66T5
HU66T6
HU66T24

HU66T1
—

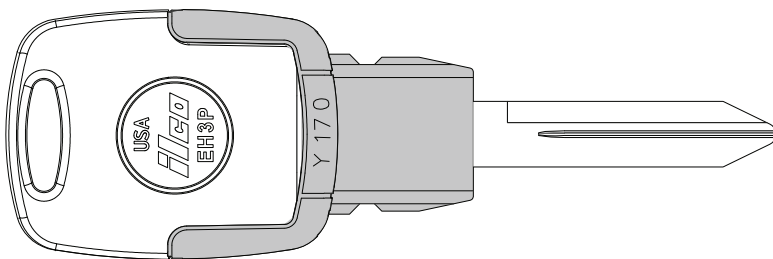
ILCO
EZ

VOLKSWAGEN
VOLVO

EH3P
(Head Only)

EB3-T-Y170
(Blade Only)

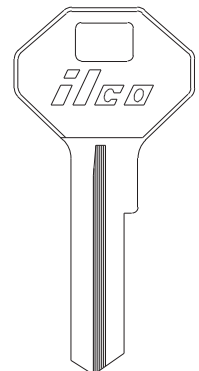
EK3P-Y170
(Complete Key)

ILCO
EZ

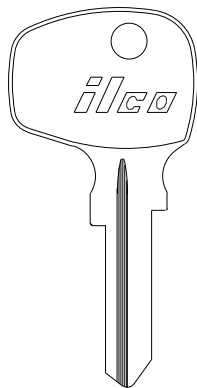
VL1
—

VOLVO

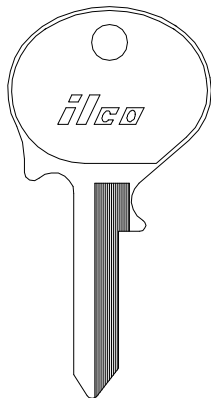

MB5

—



VO6

V77

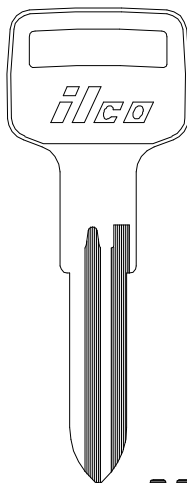

X29

VO73

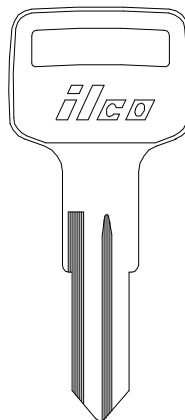

X30

VO73S

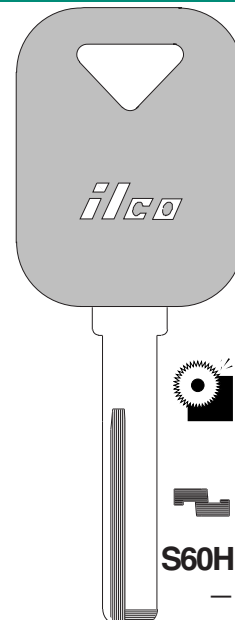

S60HF-P

—

ILCO

EZ

VOLVO

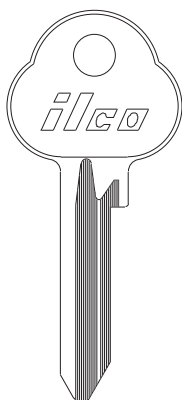

SR61W

—

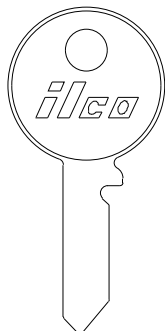

62DG 62DP

—

—

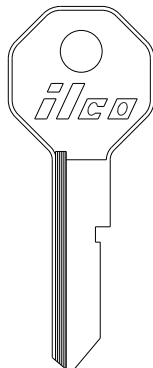

62DN

—



62DS

—

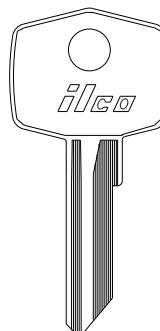

62FS

—



62VO

—

ILCO

EZ

VOLVO

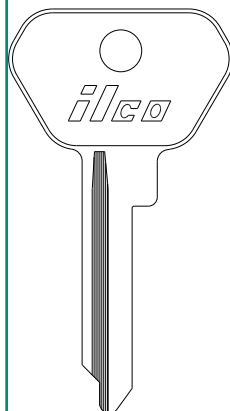

VO62

—

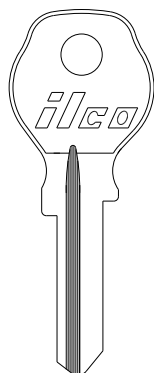

M63BG

—

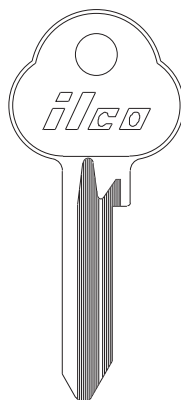

V61A

—

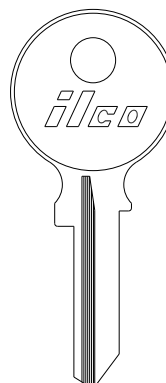

M63B

—

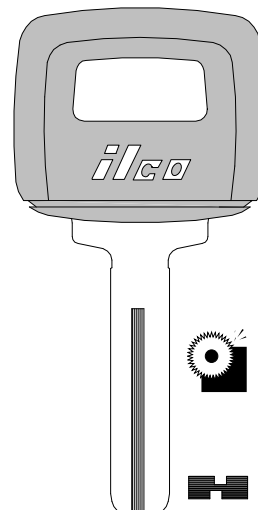

S66NN-P

—

ILCO

EZ

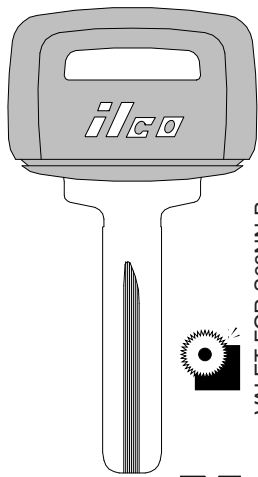
VOLVO

VALET FOR S66NN-P

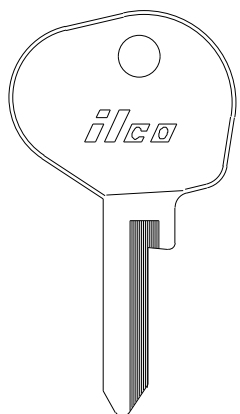
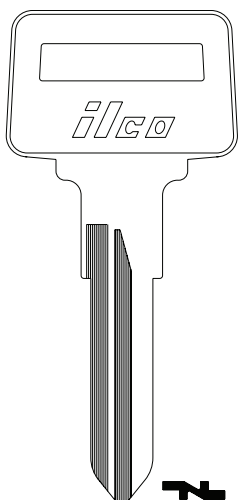
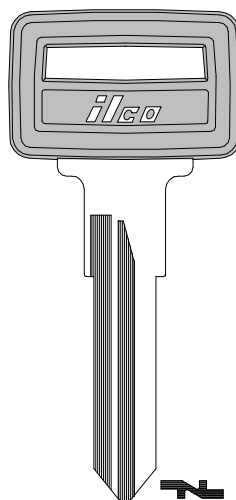
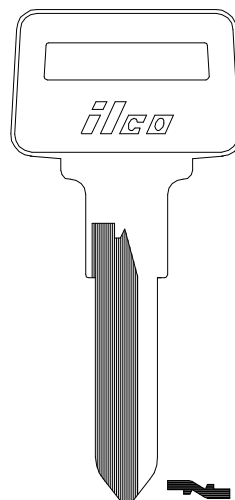

S67NN-P
—

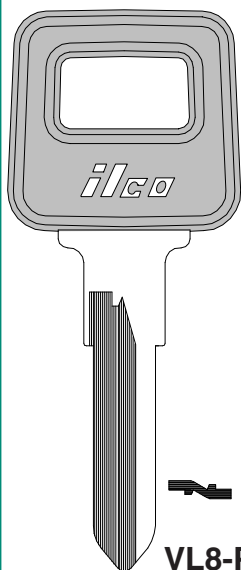
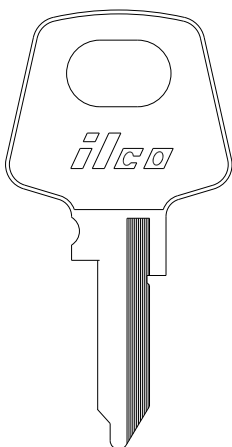
V80P
—

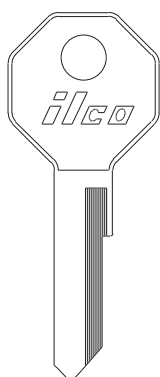
X80
VL6

VL6-P
—

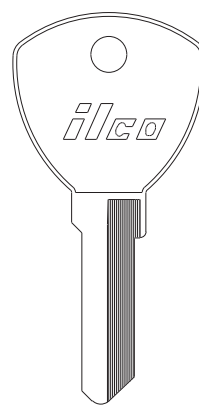
X140
VL8

ILCO
EZ

VOLVO

VL8-P
—

X163
BL11

WARTBURG

WAR1
—

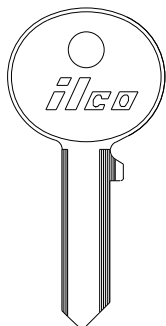
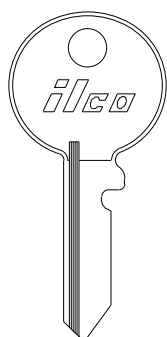
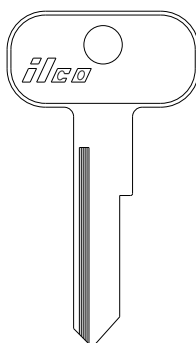
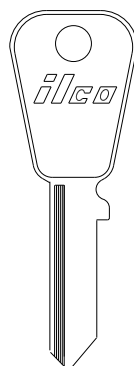
WAR3
—

WAR4
—

WA3
—

ILCO
EZ

WOLSLEY

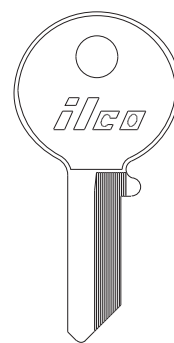
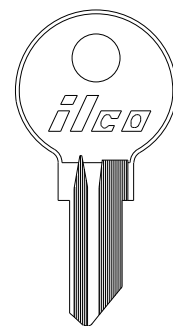
62DB
—

62DP
—

H62DP
—

S62DP
—

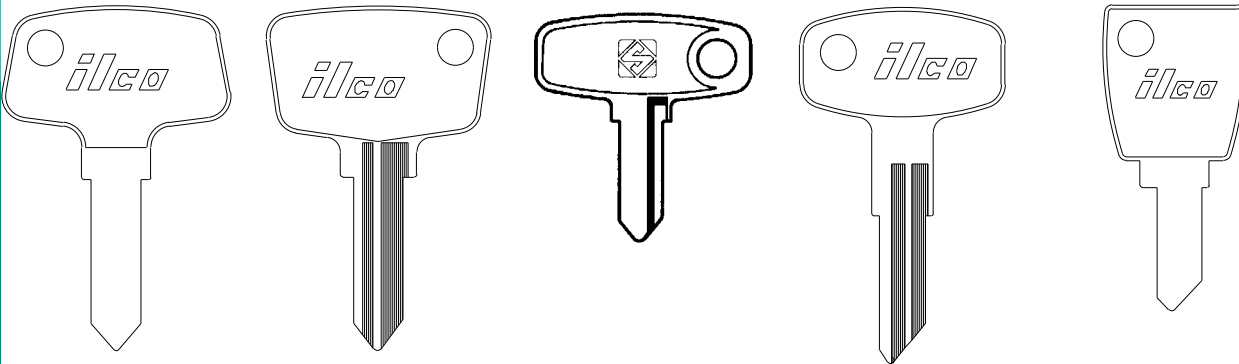
ILCO
EZ

YAMAHA

YH1
—

YH2
—

YAMAHA

VEHICLE



YH3	YH4	YH5	YH6-SI	YH6R	YH6	YH15	YH7
-	-	-	-	-	-	-	-

ILCO
EZ

YAMAHA

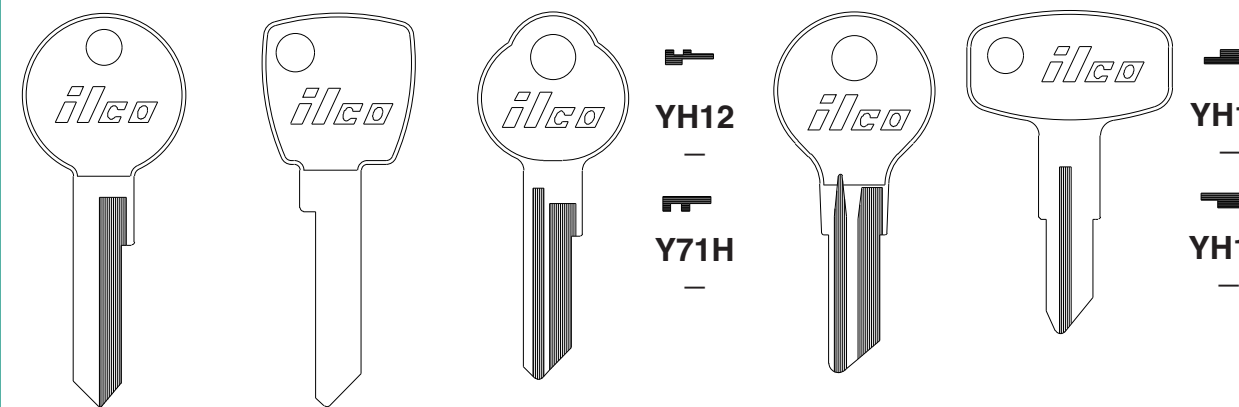

YH8	YH9	YH16	YH10	YH11	YH13
-	-	-	-	-	-

ILCO
EZ

YAMAHA

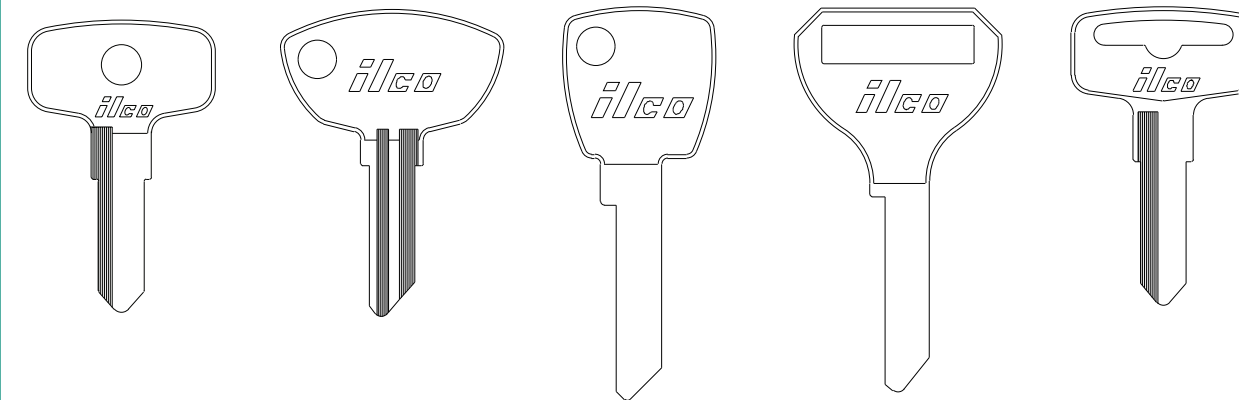

X18	X39	YH18	YH20	YH22	YH23	YH24	YH29
YH21	YH19	-	-	-	-	-	-

ILCO
EZ

YAMAHA

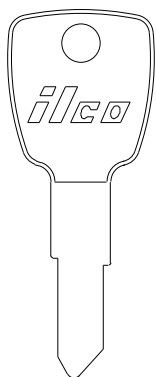

YH31

—

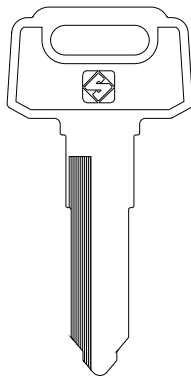

YH31R

—

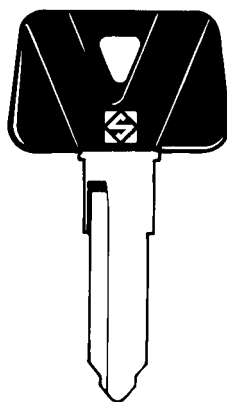

YH31RAP

—

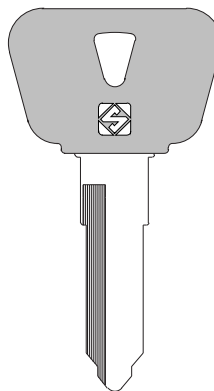

YH31RBP

—

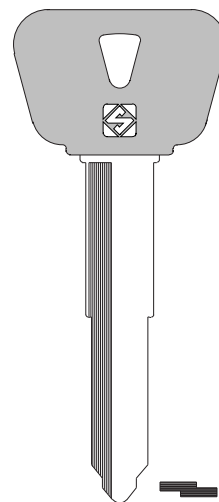

YH35RBP

—

ILCO
EZ

YAMAHA



X33

—

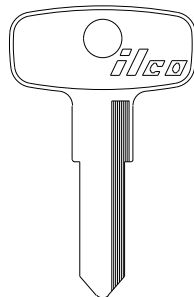

X48

—



YH40

—



YH43

—

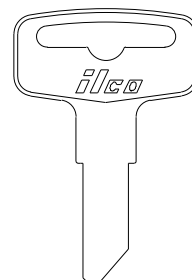

YH41

—



YH42

—

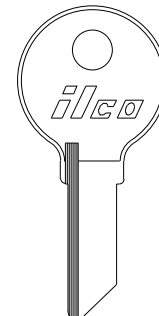

X49

—

ILCO
EZ

YAMAHA

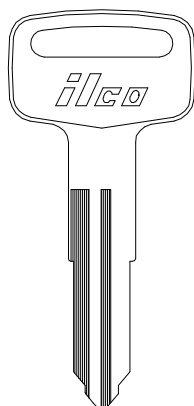

YH50

—



YH51

—

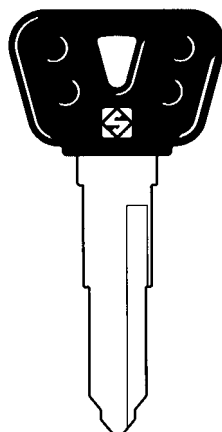

YH28BP

—



YH28RBP

—



YH29BP

—



YH29RBP

—



YH30BP

—



YH30RBP

—

ILCO
EZ

YAMAHA

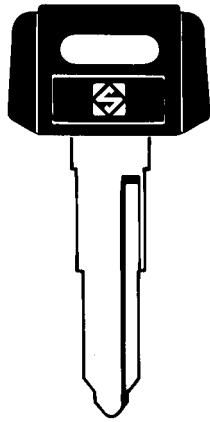

YH28P
—

YH28RP
—

YH29P
—

YH29RP
—

YH30P
—

YH30RP
—

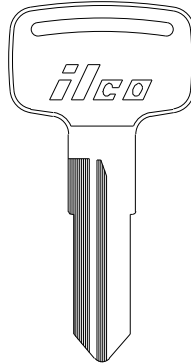

X69
YH37

X72
YH36

X75
YH33

X74
YH34

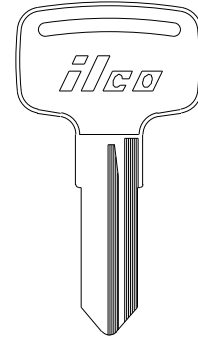

X62
YH44



X107
YH45



X63
YH32



X76
YH30

ILCO
EZ

YAMAHA

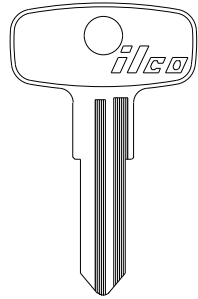
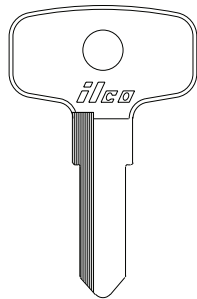

X65
YH25



X66
YH26



X67
YH28



X68
YH27



Y76B
—



Y76C
—

ILCO
EZ

YAMAHA

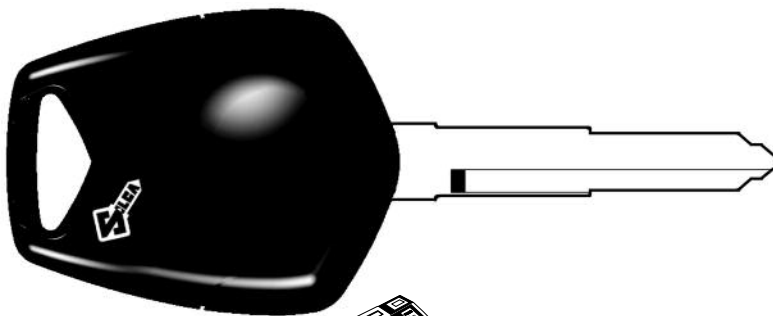

YH35REH2
—

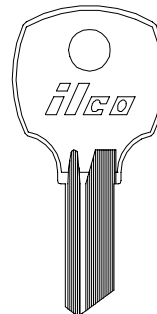

M1069L
—

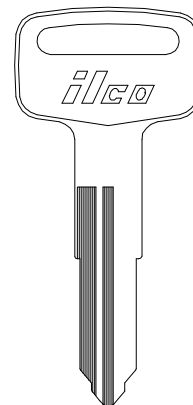

X117
YH48

ILCO
EZ

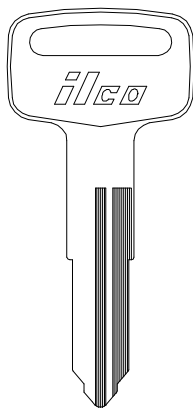
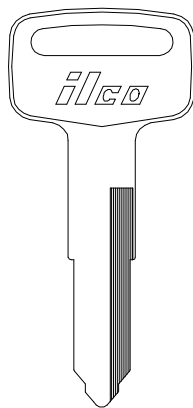
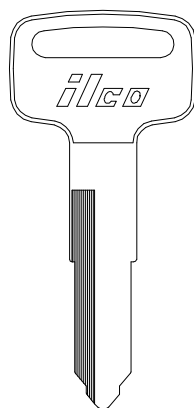
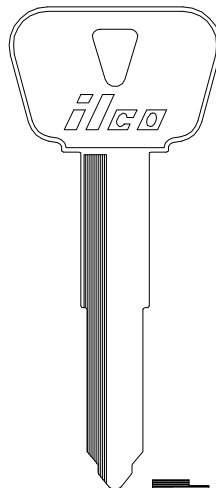
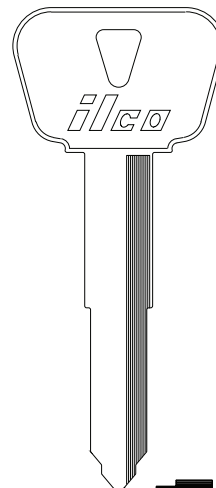
YAMAHA

X118
YH49

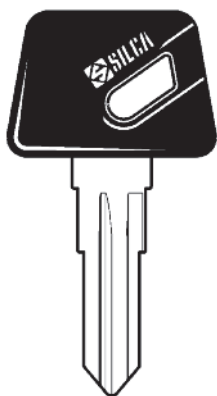
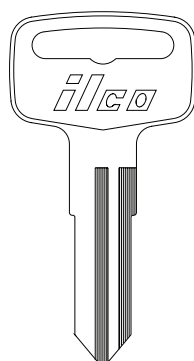
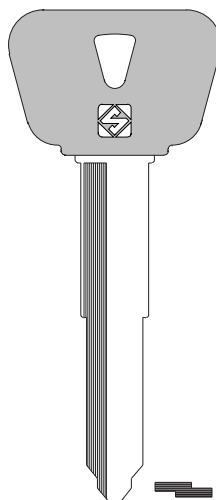
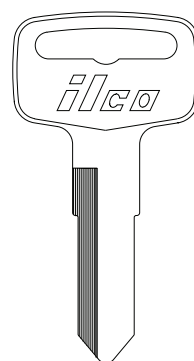
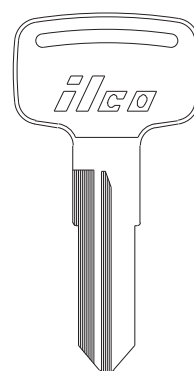
X119
YH47

X120
YH46

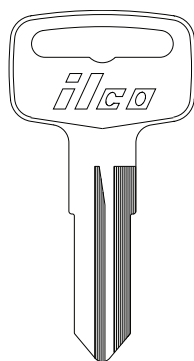
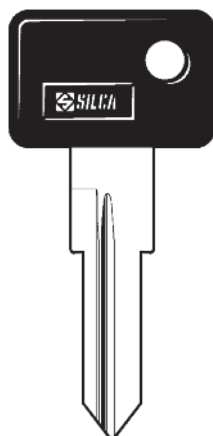
X248
YM63

X277
YM64

ILCO
EZ

YAMAHA

YH34P-SI
—

YH35
—

YH35RPB-SI
—

YH38
X77

YM55
X111

ILCO
EZ

YAMAHA

YM56
X112

ZD16RP-SI
—

ZD24RAT22-SI
—

ZD24RDP-SI
—

ZD24RT5-SI
—

ILCO
EZ

YARD TRACTOR YUGO

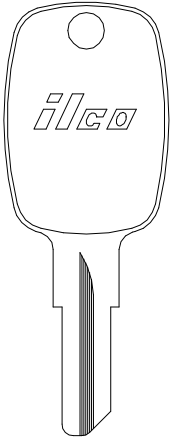

1098JD

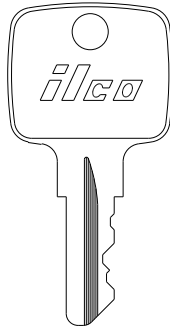

C1098JD

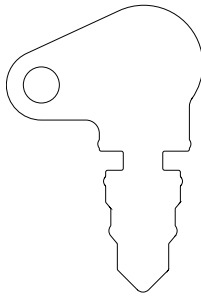

1147

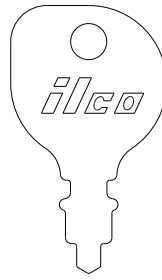

1148

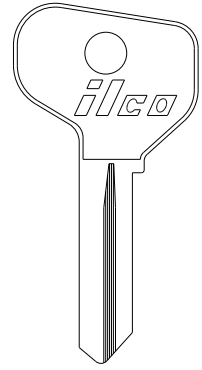

FT37



FT38

ILCO
EZ

YUGO ZEPHYR ZUNDAPP

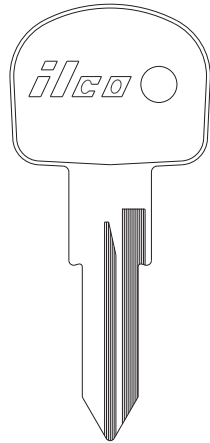

X152
FT46

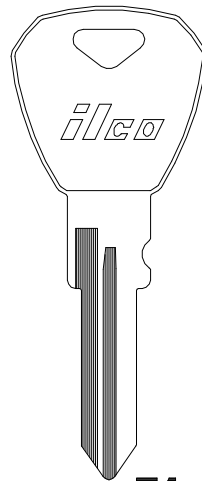

X153
YU1

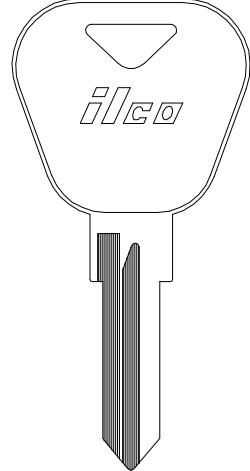

X167
YU2

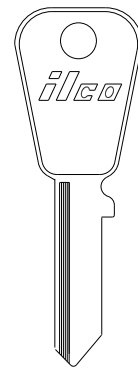

S62DP

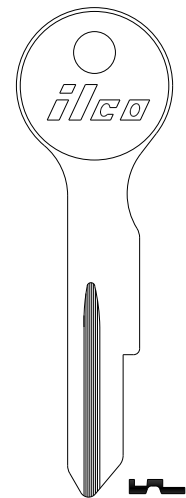

Z1

ILCO
EZ

ZUNDAPP

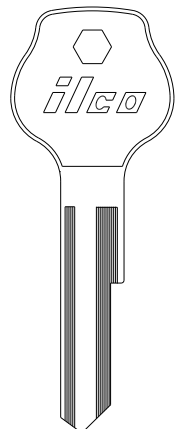

LR62VA

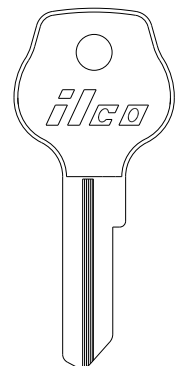

R62VA

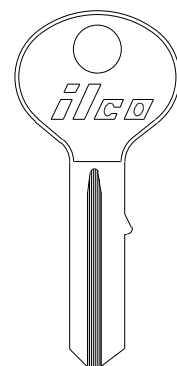

63J

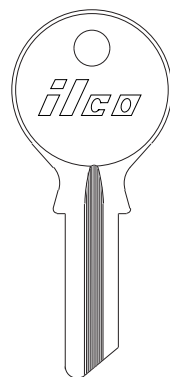

63L

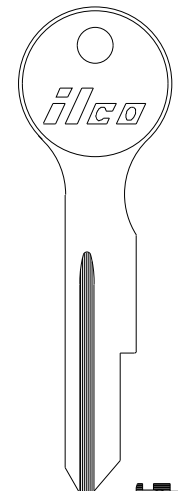

65J

ILCO
EZ