

PATIOJOY

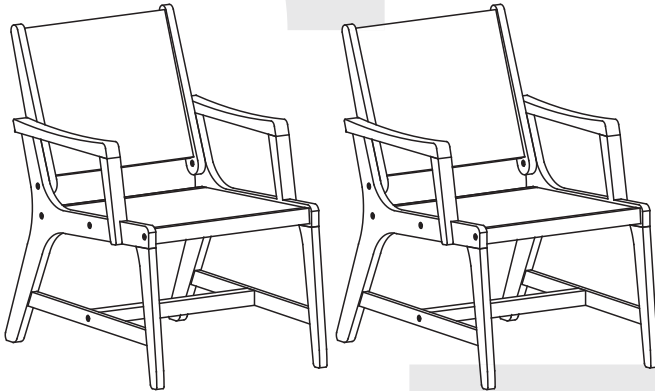

Dining Chairs Set of 2
Ensemble de Chaises de Salle à Manger de 2 Pièces

HW70896



Before You Start

- ⚠ Please read all instructions carefully.
- ⚠ Retain instructions for future reference.
- ⚠ Separate and count all parts and hardware.
- ⚠ Read through each step carefully and follow the proper order.
- ⚠ We recommend that, where possible, all items are assembled near to the area in which they will be placed in use, to avoid moving the product unnecessarily once assembled.
- ⚠ Always place the product on a flat, steady and stable surface.
- ⚠ Keep all small parts and packaging materials for this product away from babies and children as they potentially pose a serious choking hazard.



Avant de Commencer

- ⚠ Veuillez lire attentivement toutes les instructions.
- ⚠ Conservez les instructions pour vous y référer ultérieurement.
- ⚠ Vérifiez toutes les pièces et les accessoires.
- ⚠ Lisez attentivement chaque étape et suivez l'ordre correct.
- ⚠ Nous recommandons que, dans la mesure du possible, tous les produits soient assemblés à proximité de la zone où ils seront utilisés, afin d'éviter tout déplacement inutile du produit une fois assemblé.
- ⚠ Placez toujours le produit sur une surface plane et stable.
- ⚠ Conservez toutes les petites pièces de ce produit et les matériaux d'emballage hors de portée des bébés et des enfants, car ils pourraient présenter un risque d'étouffement.

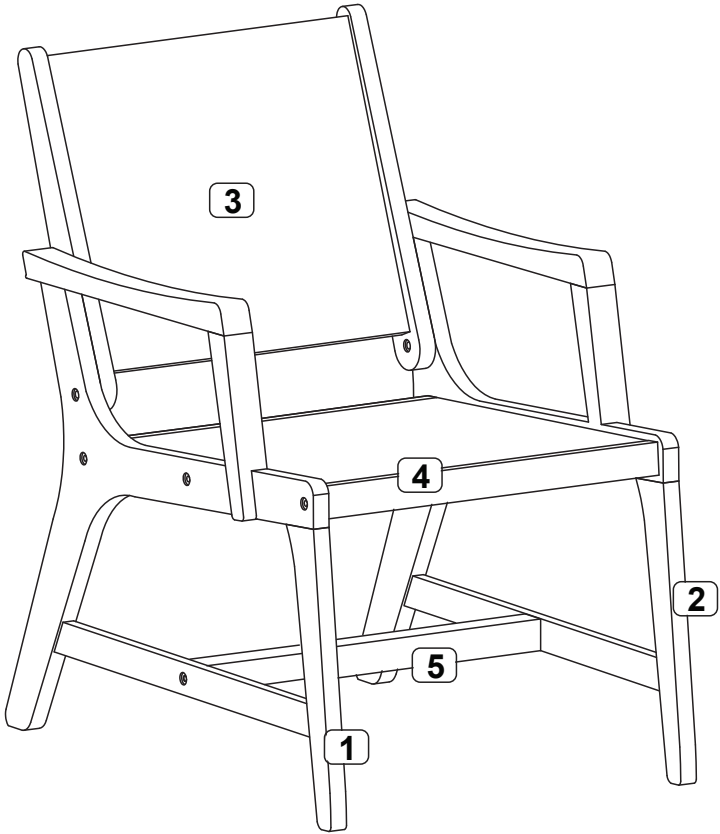

PARTS LIST / LISTE DES PIÈCES

1 x2

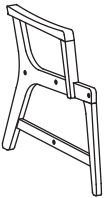

Right Leg Frame /
Cadre de jambe droite

2 x2

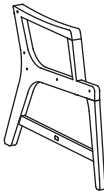

Left Leg Frame /
Cadre de jambe gauche

3 x2

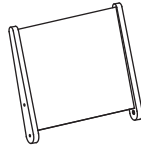

Backrest /
Dossier

4 x2

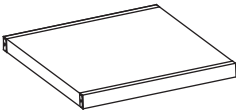

Seat / Siège

5 x2



Crossbar /
Barre transversale

A x1



M6x30mm
Bolt / Boulon

B x4

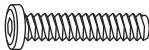

M6x40mm
Bolt / Boulon

C x4

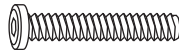

M6x50mm
Bolt / Boulon

D x8



M6x70mm
Bolt / Boulon

E x8



Cross Dowel /
Cheville croisée

F x4

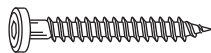

M6x50mm
Screw / Vis

G x4

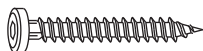

M6x45mm
Screw / Vis



H x2



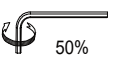

M4 Allen Key /
Clé Allen

1 X2

  50%

50%  100% 

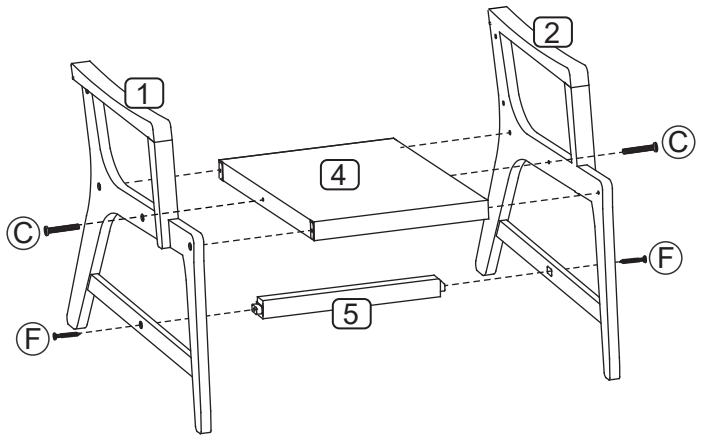

 **C** x4

 **F** x4



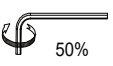

2 X2

  50%

50%  100% 

 **D** x8

 **E** x8

 **A** x1

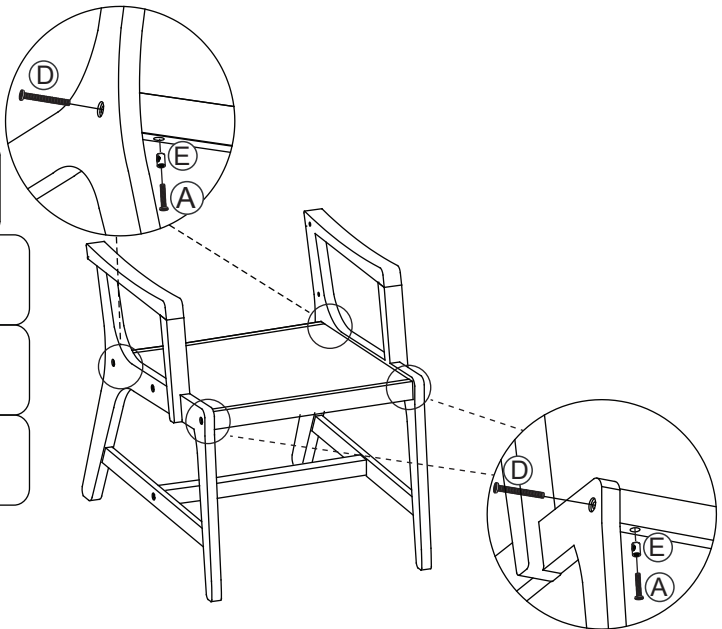

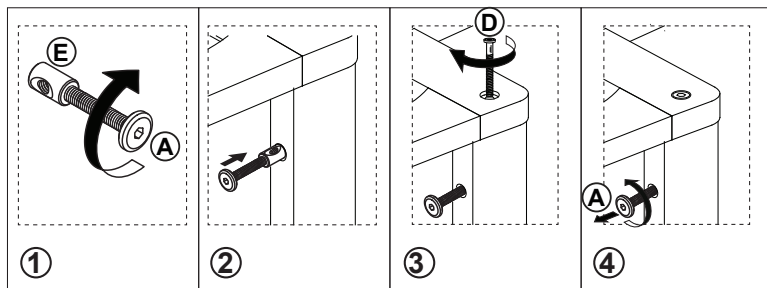

EN

- ① Fix and tighten Bolt (A) into Cross dowel (E).
- ② Insert the assembled part into the holes from bottom side of seat.
- ③ Fix and tighten Bolt (D).
- ④ Remove Bolt (A) and repeat the operation for the others.

FR

- ① Fixez et serrez le boulon (A) dans la cheville transversale (E).
- ② Insérez la pièce assemblée dans les trous du côté inférieur du siège.
- ③ Fixez et serrez le boulon (D).
- ④ Retirez le boulon (A) et répétez l'opération pour les autres.

3 X2

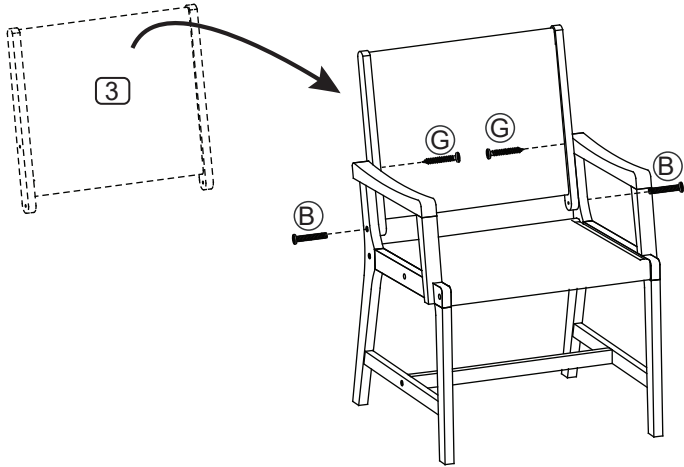
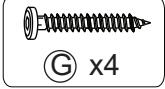
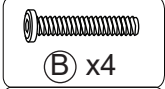
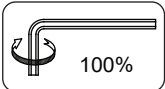

4

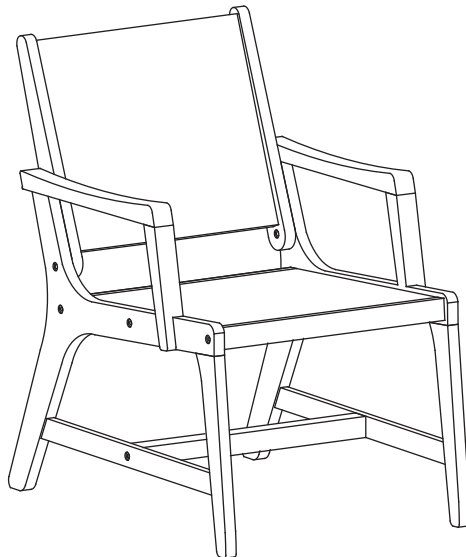
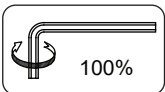

X2



Return / Damage Claim Instructions

- ⚠ **DO NOT discard the box / original packaging.**
In case a return is required, the item must be returned in original box. Without this your return will not be accepted.
- ⚠ **Take a photo of the box markings.**
A photo of the markings (text) on the side of the box is required in case a part is needed for replacement. This helps our staff identify your product number to ensure you receive the correct parts.
- ⚠ **Take a photo of the damaged part (if applicable).**
A photo of the damage is always required to file a claim and get your replacement or refund processed quickly. Please make sure you have the box even if it is damaged.
- ⚠ **Send us an email with the images requested.**
Email us directly from marketplace where your item was purchased with the attached images and a description of your claim.



Instructions De Retour / Réclamation De Dommages

- ⚠ **NE PAS jeter la boîte/l'emballage d'origine.**
Dans le cas où un retour est requis, l'article doit être retourné dans sa boîte d'origine. Sans cela, votre retour ne sera pas accepté.
- ⚠ **Prenez une photo des marquages de la boîte.**
Une photo des marquages (texte) sur le côté de la boîte est requise au cas où une pièce serait nécessaire pour le remplacement. Cela aide notre personnel à identifier votre numéro de produit pour s'assurer que vous recevez les bonnes pièces.
- ⚠ **Prenez une photo des dommages (le cas échéant).**
Une photo des dommages est toujours requise pour déposer une réclamation et obtenir rapidement votre remplacement ou votre remboursement. Assurez-vous d'avoir la boîte même si elle est endommagée.
- ⚠ **Envoyez-nous un e-mail avec les images demandées.**
Envoyez-nous un e-mail directement depuis le marché où votre article a été acheté avec les images ci-jointes et une description de votre réclamation.

PATIOJOY

USA office: Fontana **AUS** office: Truganina **GBR** office: Ipswich **FRA** office: Saint Vigor d'Ymonville

If you're having difficulty, our friendly customer team is always here to help.



USA: cs.us@costway.com
AUS: cs.au@costway.com
GBR: cs.uk@costway.com
FRA: cs.fr@costway.com