

# MULTI-PURPOSE BENCH

## FM-504 / FM-TN504

### Assembly Manual

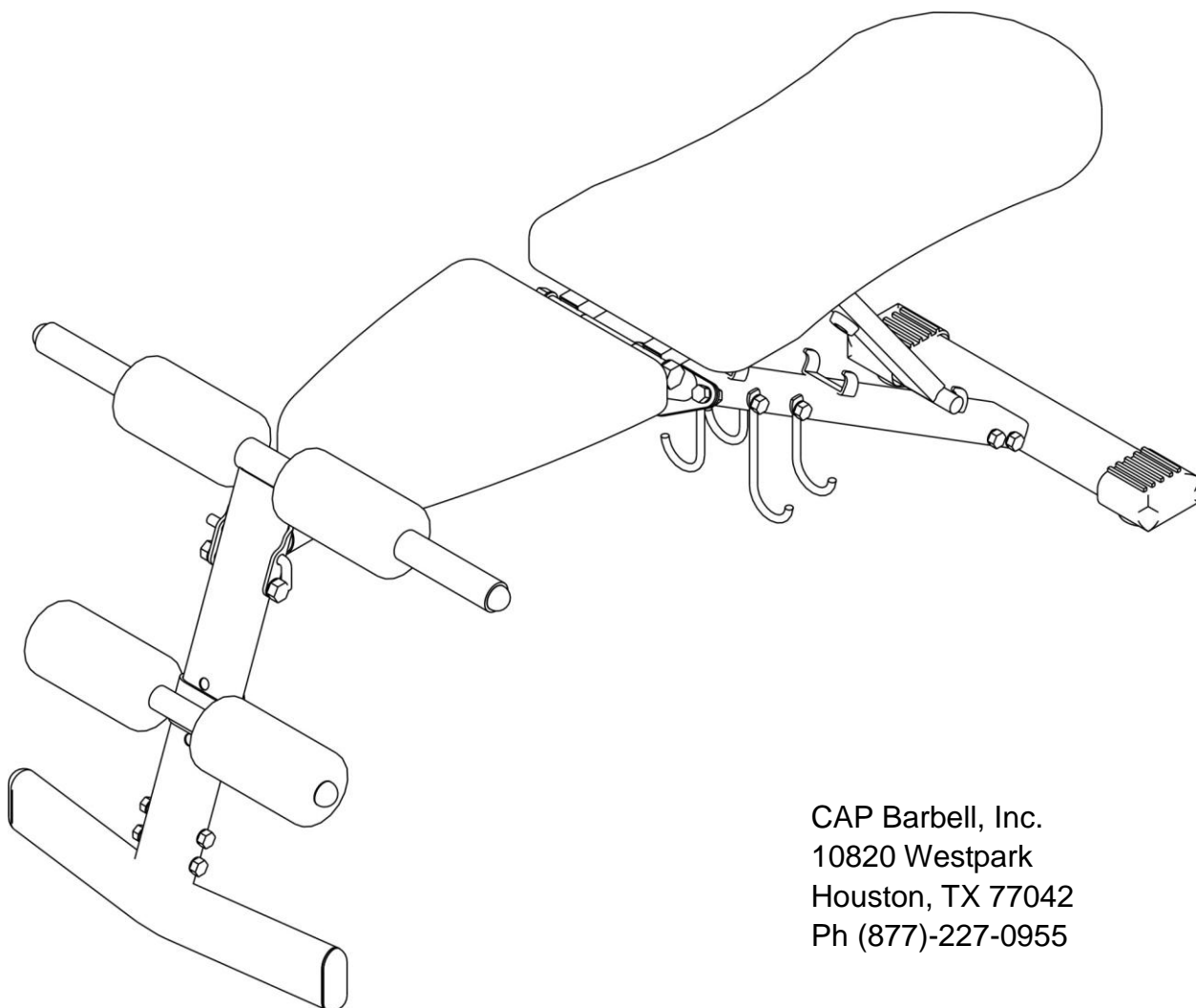

CAP Barbell, Inc.  
10820 Westpark  
Houston, TX 77042  
Ph (877)-227-0955

# TABLE OF CONTENTS

WARNING DECAL PLACEMENT.....	2
BENCH OVERVIEW & DIMENSIONS .....	3
BEFORE YOU BEGIN/PRECAUTIONS.....	4
EXPLODED VIEW.....	5
PARTS LIST.....	6
ASSEMBLY.....	8
EXERCISE GUIDELINES.....	11
MANUFACTURERS WARRANTY.....	13

Note: A PART IDENTIFICATION CHART and a PART LIST/EXPLODED DRAWING are attached in the center of this manual. Remove the PART IDENTIFICATION CHART and PART LIST/EXPLODED DRAWING before beginning assembly.

## WARNING DECAL PLACEMENT

The decals shown here have been placed on the weight bench. If the decal is missing or illegible, please call toll-free 877-227-0955, Monday through Friday 9 a.m. until 4 p.m. Central Time, and order a free replacement Decal. Apply the decal in the location shown.

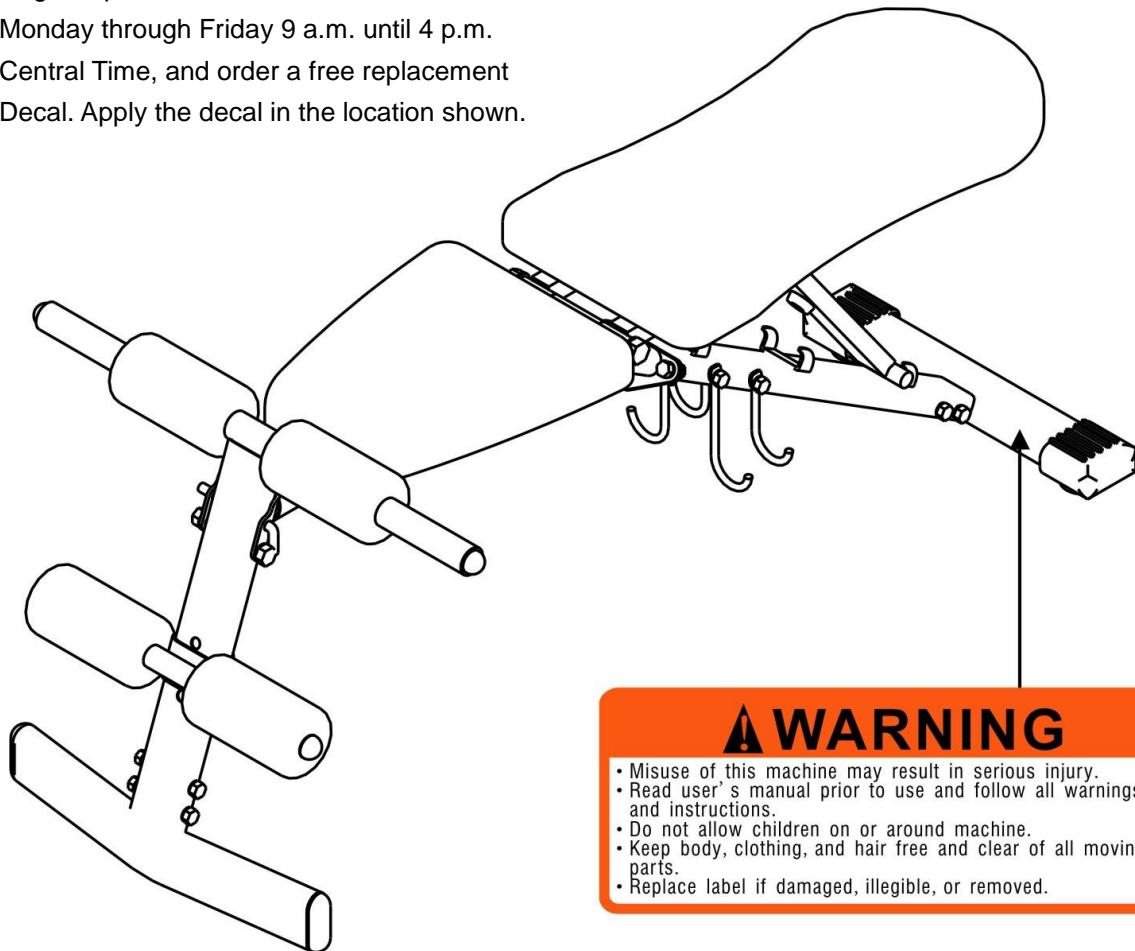

### **▲ WARNING**

- Misuse of this machine may result in serious injury.
- Read user's manual prior to use and follow all warnings and instructions.
- Do not allow children on or around machine.
- Keep body, clothing, and hair free and clear of all moving parts.
- Replace label if damaged, illegible, or removed.

Thank you for selecting your CAP Strength product. This bench will help you build and tone major muscle groups in the body. Please read this manual carefully before using your bench. please look at diagram below to get familiar will your new bench.

reading this manual, call 877-227-0955. To help assist you, please note the product model number before calling. The model number is FM-504 or FM-TN504

Before reading further, please look at the drawing below and familiarize yourself with the parts that are labeled.

**For your benefit, read this manual carefully before using the product.** If you have questions after

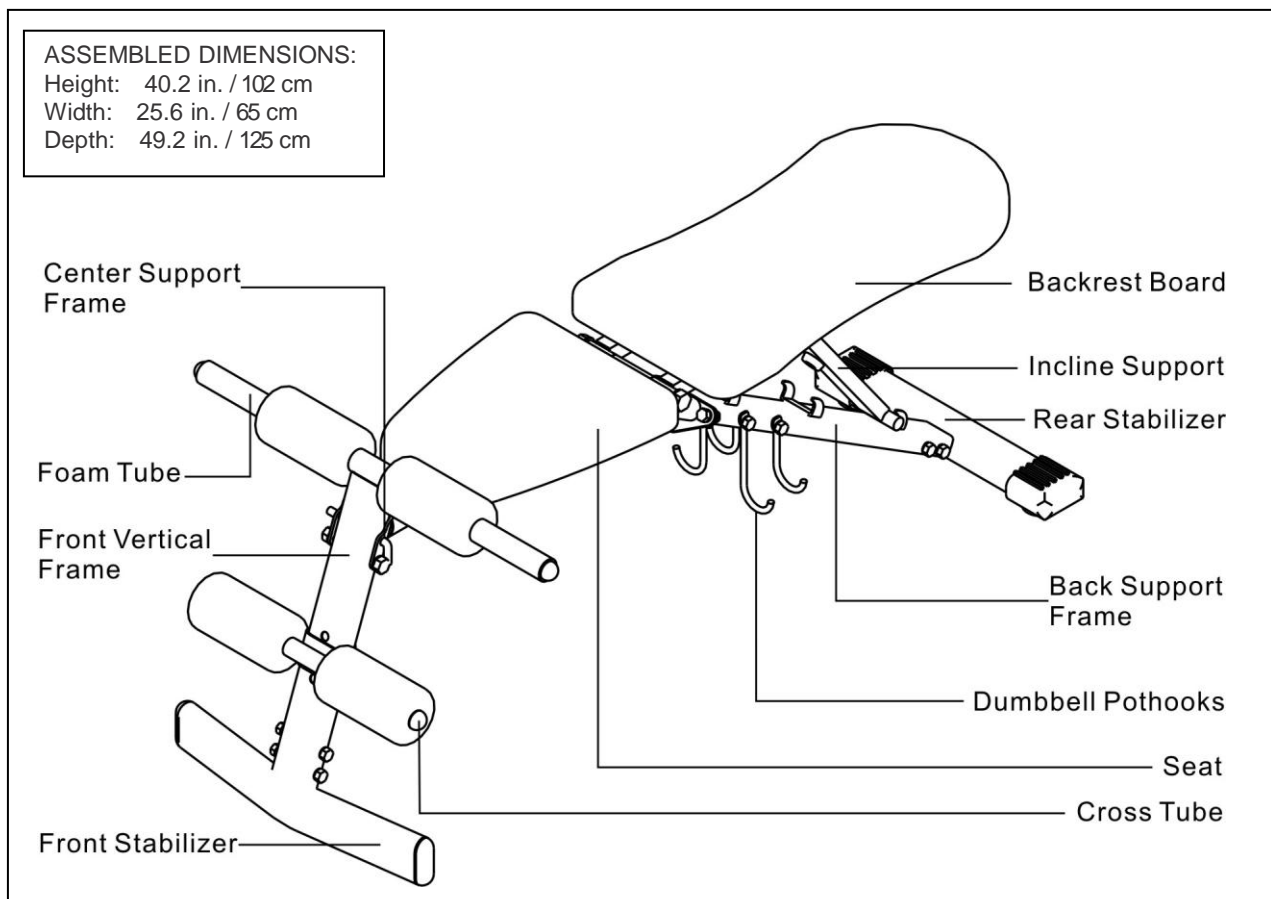

## TOOLS NEEDED

### Make Things Easier for Yourself





This manual is designed to ensure that the weight bench can be assembled successfully by anyone. Most people find that by setting aside plenty of time, assembly will go smoothly.

**Before beginning assembly, carefully read the following information and instructions:**

- Assembly requires two people.
- For help identifying small parts, see the **PART IDENTIFICATION CHART**.
- Tighten all parts as you assemble them, unless instructed to do otherwise.
- As you assemble this product, make sure all parts are oriented as shown in the drawings.

- Place all parts in a cleared area and remove the packing materials. Do not dispose of the packing materials until assembly is completed.

**The following tools (not included) may be required for assembly:**

- **Two adjustable wrenches** 
- **One hammer** 
- **One standard screwdriver** 
- **One Phillips screwdriver** 

Assembly will be more convenient if you have a socket set, a set of open-end or closed-end wrenches, or a set of ratchet wrenches.

# IMPORTANT PRECAUTIONS

**⚠️ WARNING:** To reduce the risk of serious injury, read the following important precautions before using this product.

1. Read all instructions in this manual and all warnings on the bench before using. Use this product only as described in this manual.
2. It is the responsibility of the owner to ensure that all users of this product adequately informed of all precautions.
3. This bench is intended for home use only. Do not use this bench in any commercial, rental, or institutional setting.
4. Keep this bench indoors, away from moisture and dust. Place the bench on a level surface, with a mat beneath it to protect the floor or carpet. Make sure that there is enough clearance around the bench to mount, dismount, and use the bench.
5. Inspect and properly tighten all parts regularly. Replace any worn parts immediately.
6. Keep children under the age of 12 and pets away from this bench at all times.
7. Keep hands and feet away from moving parts.
8. Always wear athletic shoes for foot protection while exercising.
9. This bench is designed to support a maximum weight capacity of **300 lbs** including user.
10. If you feel pain or dizziness at any time while exercising, stop immediately and begin cooling down.
11. Before each use make sure that the incline support (7) is placed securely within the brackets on the back support frame (2).

**⚠️ WARNING:** Before beginning this or any exercise program, consult your physician. This is especially important for persons over the age of 35 or persons with pre-existing health problems. Read all instructions before using. Cap Barbell assumes no responsibility for personal injury or property damage sustained by or through the use of this product.



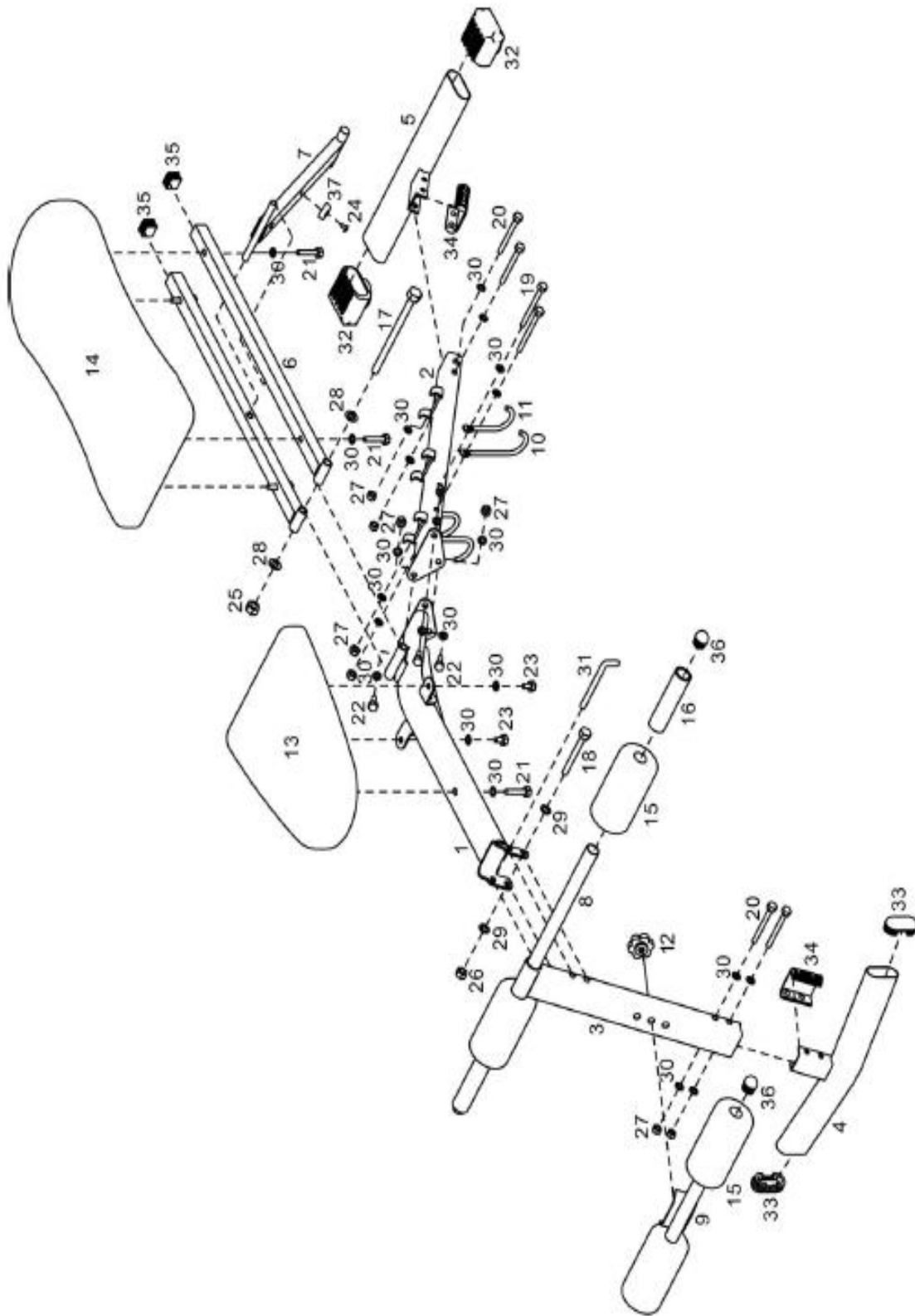









# EXPLODED DIAGRAM













# PART LIST

No.	Part No.	Description	Qty.	Pre.-assembled
1	PFM504-01	Center Support Frame	1	No
2	PFM504-02	Back Support Frame	1	No
3	PFM504-03	Front Vertical Frame	1	No
4	PFM504-04	Front Stabilizer	1	No
5	PFM504-05	Rear Stabilizer	1	No
6	PFM504-06	Backrest Supports	2	No
7	PFM504-07	Incline Support	1	No
8	PFM504-08	Foam Tube	1	No
9	PFM504-09	Cross Tube	1	No
10	PFM504-10	Long Dumbbell Pothooks	2	No
11	PFM504-11	Short Dumbbell Pothooks	2	No
12	PFM504-12	Knob	1	No
13	PFM504-13	Seat	1	No
14	PFM504-14	Backrest Board	1	No
15	PFM504-15	Foam Rolls	4	No
16	PFM504-16	Foam Grips	2	No
17	PFM504-17	M12 x 180mm Bolt	1	No
18	PFM504-18	M10 x 90mm Bolt	1	No
19	PFM504-19	M8 x 90mm Bolts	2	No

No.	Part No.	Description	Qty.	Pre.-assembled
20	PFM504-20	M8 x 80mm Bolts	4	No
21	PFM504-21	M8 x 45mm Bolts	5	No
22	PFM504-22	M8 x 20mm Bolts	3	No
23	PFM504-23	M8 x 15mm Bolts	2	No
24	PFM2240-23	M6 x 15mm Screw	1	No
25	PRK3E-04	M12 Nylon Locknut	1	No
26	PFMS80-27	M10 Nylon Locknut	1	No
27	PFMS80-16	M8 Nylon Locknuts	9	No
28	PRK3E-05	M12 Washers	2	No
29	PFMS80-28	M10 Washers	2	No
30	PFMS80-15	M8 Washers	25	No
31	PFM504-24	L-shaped Lock Pin	1	No
32	PFMG3007-01	30x70mm Rubber End Caps	2	No
33	PFMG3251-22	30x70mm Inner Caps	2	No
34	PFM504-25	U-shaped Sleeves	2	No
35	PFM2240-32	25mm Square Inner Caps	2	Yes
36	PFM504-26	25mm Round Inner Caps	4	No
37	PFM504-27	Rubber Bumper	1	Yes

NO.	DRAWING	Q'TY
1	 Center Support Frame	1
2	 Back Support Frame	1
3	 Front Vertical Frame	1
4	 Front Stabilizer	1
5	 Rear Stabilizer	1
6	 Backrest Supports	2
7	 Incline Support	1
8	 Foam Tube	1
9	 Cross Tube	1
10	 Long Dumbbell Pothooks	2
11	 Short Dumbbell Pothooks	2
12	 Knob	1

NO.	DRAWING	Q'TY
13	 Seat	1
14	 Backrest Board	1
15	 Foam Rolls	4
16	 Foam Grips	2
31	 L-shaped Lock Pin	1
32	 30x70mm Rubber End Caps	2
33	 30x70mm Inner Caps	2
34	 U-shaped Sleeves	2
35	 25mm Square Inner Caps	2
36	 25mm Round Inner Caps	4
37	 Rubber Bumper	1

# ASSEMBLY INSTRUCTION:

## STEP 1:

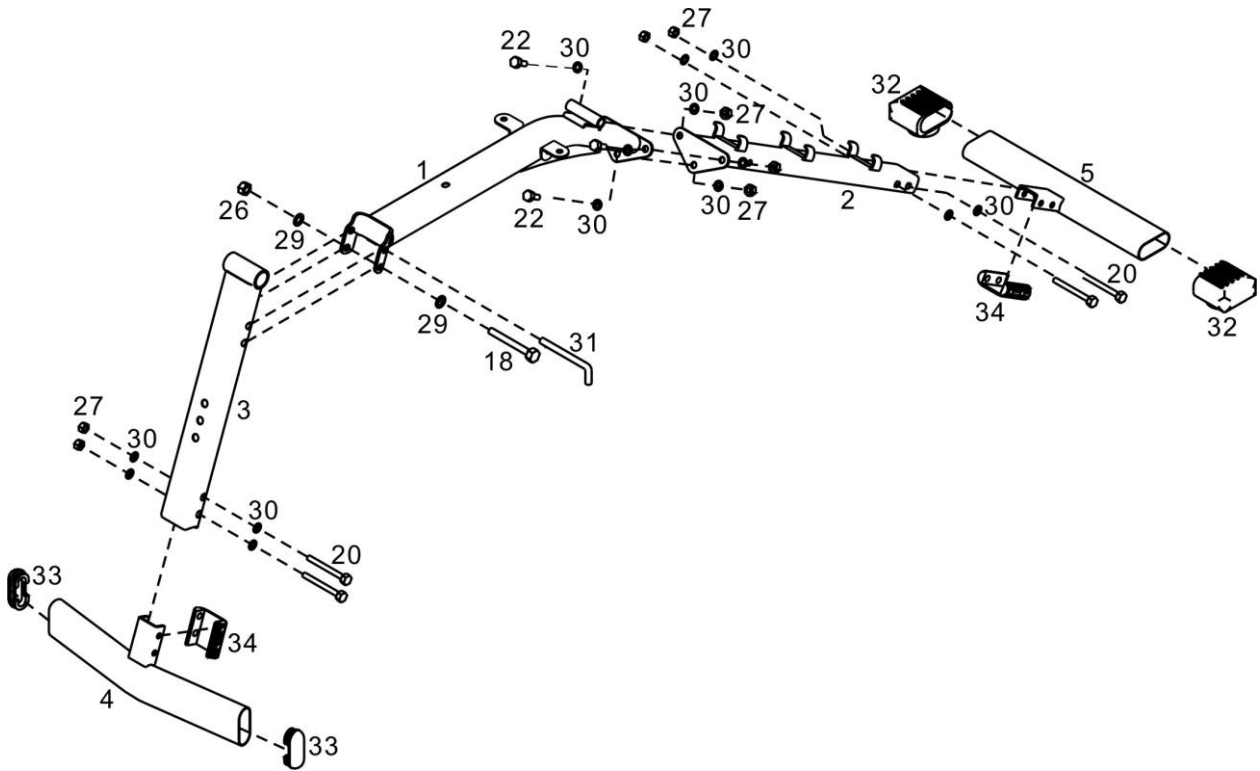

- A.) Push two Inner Caps (#33) into the Front Stabilizer (#4). Push two Rubber End Caps (#32) into the Rear Stabilizer (#5).
- B.) Attach a U-shaped Sleeve (#34) onto the bracket on the Front Stabilizer (#4). Make sure the opening on the Sleeve is facing towards the front. Attach the Front Stabilizer to the Front Vertical Frame (#3). Secure it with two M8 x 80mm Bolts (#20), four M 8 Washers (#30), and two M8 Nylon Locknuts (#27).
- C.) Attach one U-shaped Sleeve (#34) to the bracket on the Rear Stabilizer (#5). Attach the Back Support Frame (#2) to the Rear Stabilizer (#5). Secure it with two M8 x 80mm Bolts (#20), four M8 Washers (#30), and two M8 Nylon Locknuts (#27).
- D.) Connect the Center Support Frame (#1) to the Back Support Frame (#2). Secure the Lower hole with three M8 x 20mm Bolts (#22), six M8 Washers (#30), and three M8 Nylon Locknuts (#27).
- E.) Connect the Center Support Frame (#1) to the Front Vertical Frame (#3). Secure the lower hole with one M10 x 90mm Bolt (#18), two M10 Washers (#29), and one M10 Nylon Locknut (#26). Insert a L-shaped Lock Pin (#31) through the upper hole to lock the Front Vertical Frame in position. Remove the Pin when folding the bench for storage.



**STEP 2:**

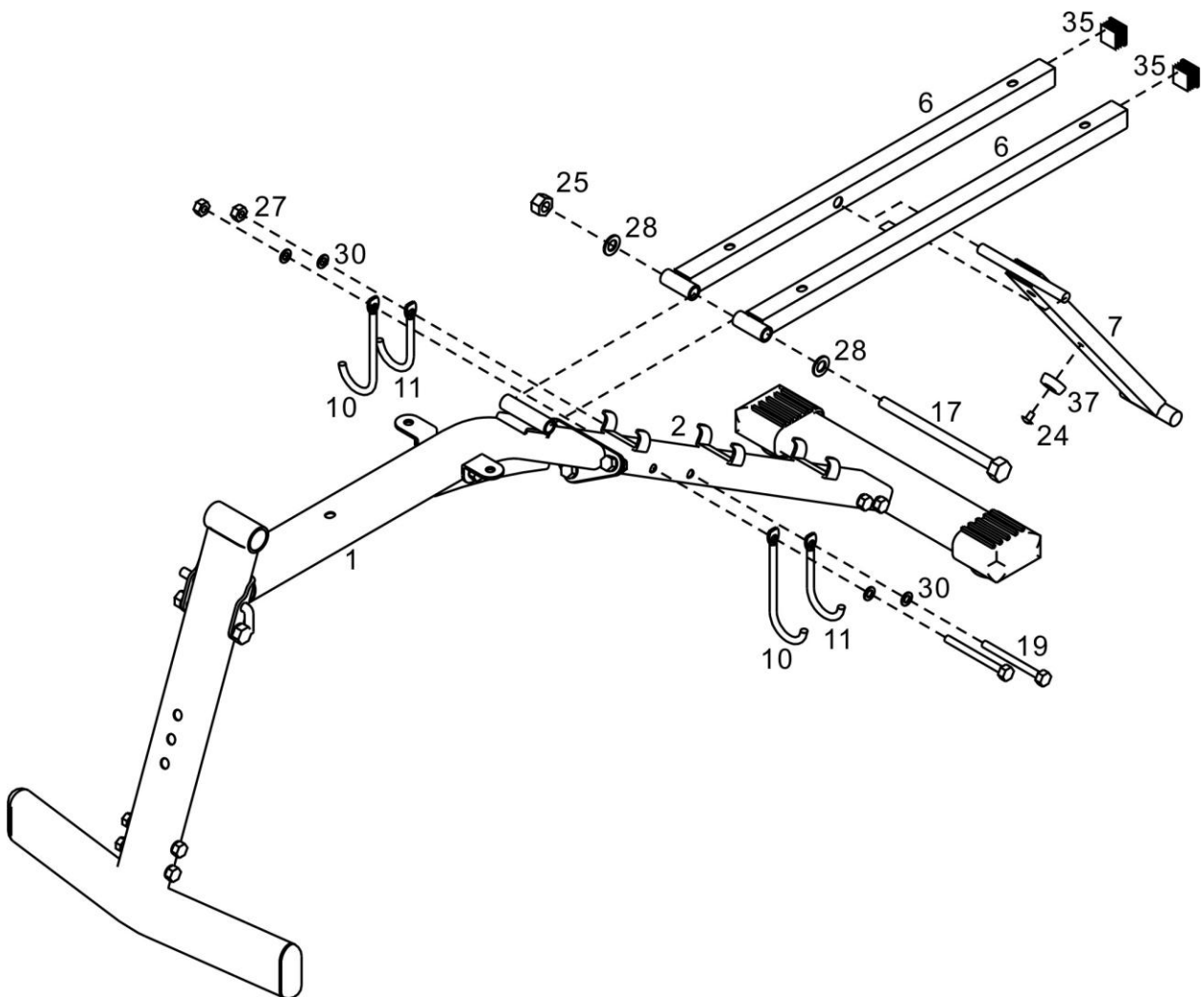

- A.) Push two Square Inner Caps (#35) into the Backrest Support (#6). Push one M6 x 15mm Screw (#24) and Rubber Bumper (#37) into the Incline Support (#7). Attach the Incline Support (#7) in between the two Backrest Supports (#6).
- B.) Attach the Pivot of the Backrest Supports (#6) to the Pivot on the Center Support Frame (#1). Secure them with one M12 x 180mm Bolt (#17), two M12 Washers (#28), and one M12 Nylon Locknut (#25).
- C.) Attach two Long Dumbbell Pothook (#10) and Short Dumbbell Pothook (#11) to the Back Support Frame (#2). Secure them with two M8 x 90mm Bolts (#19), four M8 Washers (#30), and two M8 Nylon Locknuts (#27).

**STEP 3:**

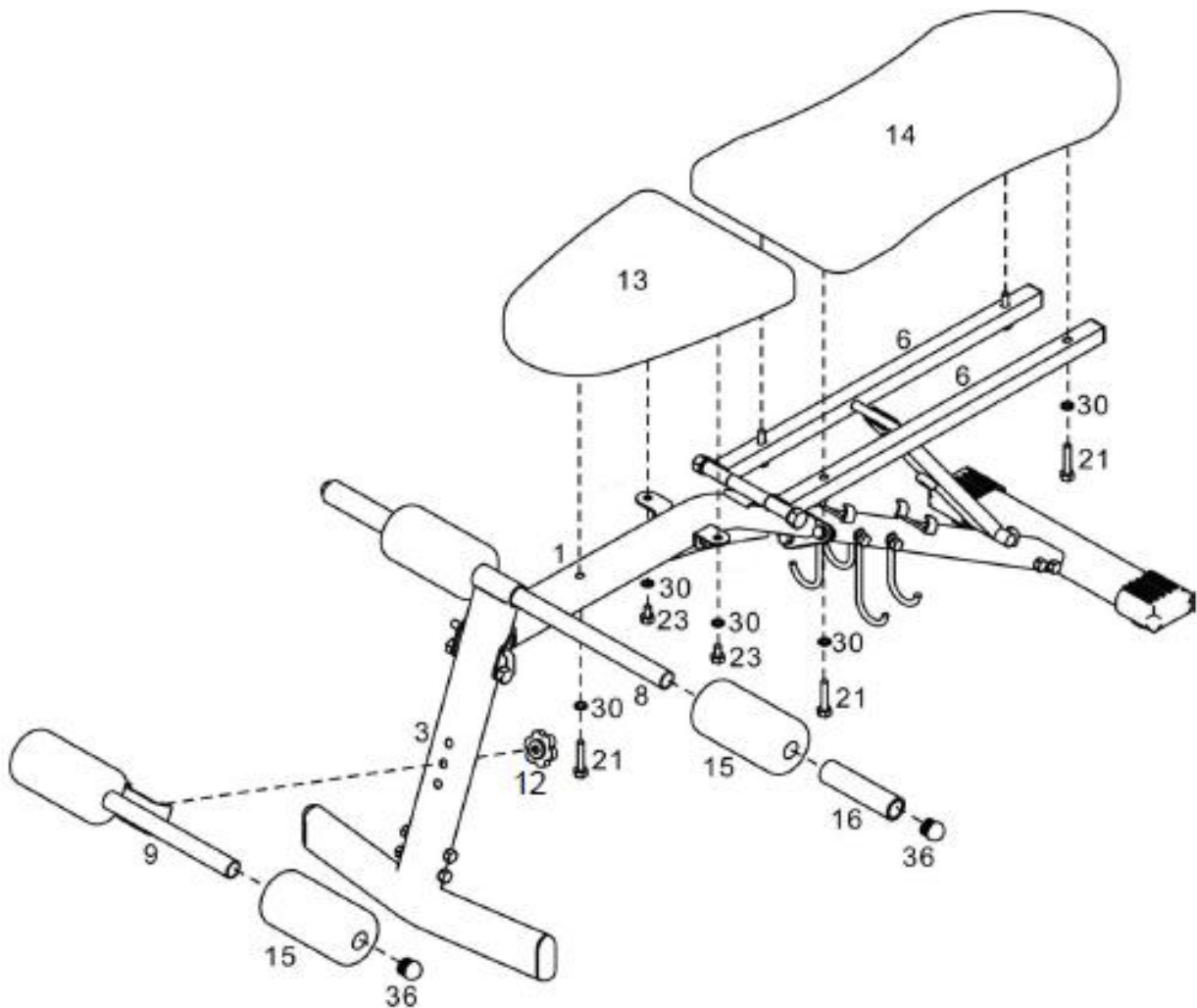

A.) Place the Seat (#13) onto the Center Support Frame (#1). Secure it to the Center Support – Frame (#1) with two M8 x15mm Bolts (#23) and M8 Washers (#30). Secure the Seat to the Center Support Frame with one M8 x 45mm Bolt (#21) and M8 Washer (#30).

B.) Place the Backrest Board (#14) onto the Backrest Supports (#6). Secure it with four M8 x 45mm Bolts (#21) and M8 Washers (#30).

C.) Attach the Cross Tube (#9) to the Front Vertical Frame (#3). Use a Knob (#12) to secure the Tube at selected hole. Push two Foam Rolls (#15) onto the Cross Tube.

D.) Insert the Foam Tube (#8) halfway through the hole on the Front Vertical Frame (#3). Push two Foam Rolls (#15) onto the Tube.

E.) Lubricate the inside of the Foam Grips (#16) with water. Slide the Foam Grips onto the Foam Tube (#8) from both sides. 12

# EXERCISE GUIDELINES

## THE FOUR BASIC TYPES OF WORKOUTS

### Muscle Building

To increase the size and strength of your muscles, push them close to their maximum capacity. Your muscles will continually adapt and grow as you progressively increase the intensity of your exercise. You can adjust the intensity level of an individual exercise in two ways:

- by changing the amount of resistance used
- by changing the number of repetitions or sets performed. (A "repetition" is one complete cycle of an exercise, such as one sit-up. A "set" is a series of repetitions.)

The proper amount of resistance for each exercise depends upon the individual user. You must gauge your limits and select the amount of resistance that is right for you. Begin with 3 sets of 8 repetitions for each exercise you perform. Rest for 3 minutes after each set. When you can complete 3 sets of 12 repetitions without difficulty, increase the amount of resistance.

### Toning

You can tone your muscles by pushing them to a moderate percentage of their capacity. Select a moderate amount of resistance and increase the number of repetitions in each set. Complete as many sets of 15 to 20 repetitions as possible without discomfort. Rest for 1 minute after each set. Work your muscles by completing more sets rather than by using high amounts of resistance.

### Weight Loss

To lose weight, use a low amount of resistance and increase the number of repetitions in each set. Exercise for 20 to 30 minutes, resting for a maximum of 30 seconds between sets.

### Cross Training

Cross training is an efficient way to get a complete and well-balanced fitness program. An example of a balanced program is:

- Plan strength training workouts on Monday, Wednesday, and Friday.
- Plan 20 to 30 minutes of aerobic exercise, such as running on a treadmill or riding on an exercise cycle or an elliptical exerciser, on Tuesday and Thursday.
- Rest from both strength training and aerobic exercise for at least one full day each week to give your body time to regenerate.

The combination of strength training and aerobic exercise will reshape and strengthen your body, plus develop your heart and lungs.

## PERSONALIZING YOUR EXERCISE PROGRAM

Determining the exact length of time for each workout, as well as the number of repetitions or sets completed, is an individual matter. It is important to avoid overdoing it during the first few months of your exercise program. You should progress at your own pace and be sensitive to your body's signals. If you experience pain or dizziness at any time while exercising, stop immediately and begin cooling down. Find out what is wrong before continuing. Remember that adequate rest and a proper diet are important factors in any exercise program.

### WARMING UP

Begin each workout with 5 to 10 minutes of stretching and light exercise to warm up. Warming up prepares your body for more strenuous exercise by increasing circulation, raising your body temperature and delivering more oxygen to your muscles.

## WORKING OUT

Each workout should include 6 to 10 different exercises. Select exercises for every major muscle group, emphasizing areas that you want to develop most. To give balance and variety to your workouts, vary the exercises from session to session. Schedule your workouts for the time of day when your energy level is the highest. Each workout should be followed by at least one day of rest. Once you find the schedule that is right for you, stick with it.

## EXERCISE FORM

Maintaining proper form is an essential part of an effective exercise program. This requires moving through the full range of motion for each exercise, and moving only the appropriate parts of the body. Exercising in an uncontrolled manner will leave you feeling exhausted. See the muscle chart below to find the names of the muscles.

The repetitions in each set should be performed smoothly and without pausing. The exertion stage of each repetition should last about half as long as the return stage. Proper breathing is important. Exhale during the exertion stage of each repetition and inhale during the return stroke. Never hold your breath.

Rest for a short period of time after each set. The ideal resting periods are:

- Rest for three minutes after each set for a muscle-building workout.
- Rest for one minute after each set for a toning workout.
- Rest for 30 seconds after each set for a weight loss workout.

Plan to spend the first couple of weeks familiarizing yourself with the equipment and learning the proper form for each exercise.

## COOLING DOWN

End each workout with 5 to 10 minutes of stretching. Include stretches for both your arms and legs. Move slowly as you stretch and do not bounce. Ease into each stretch gradually and go only as far as you can without strain. Stretching at the end of each workout is an effective way to increase flexibility.

## STAYING MOTIVATED

For motivation, keep a record of each workout. List the date, the exercises performed, the resistance used, and the numbers of sets and repetitions completed. Record your weight and key body measurements at the end of every month. Remember, the key to achieving the greatest results is to make exercise a regular and enjoyable part of your everyday life.

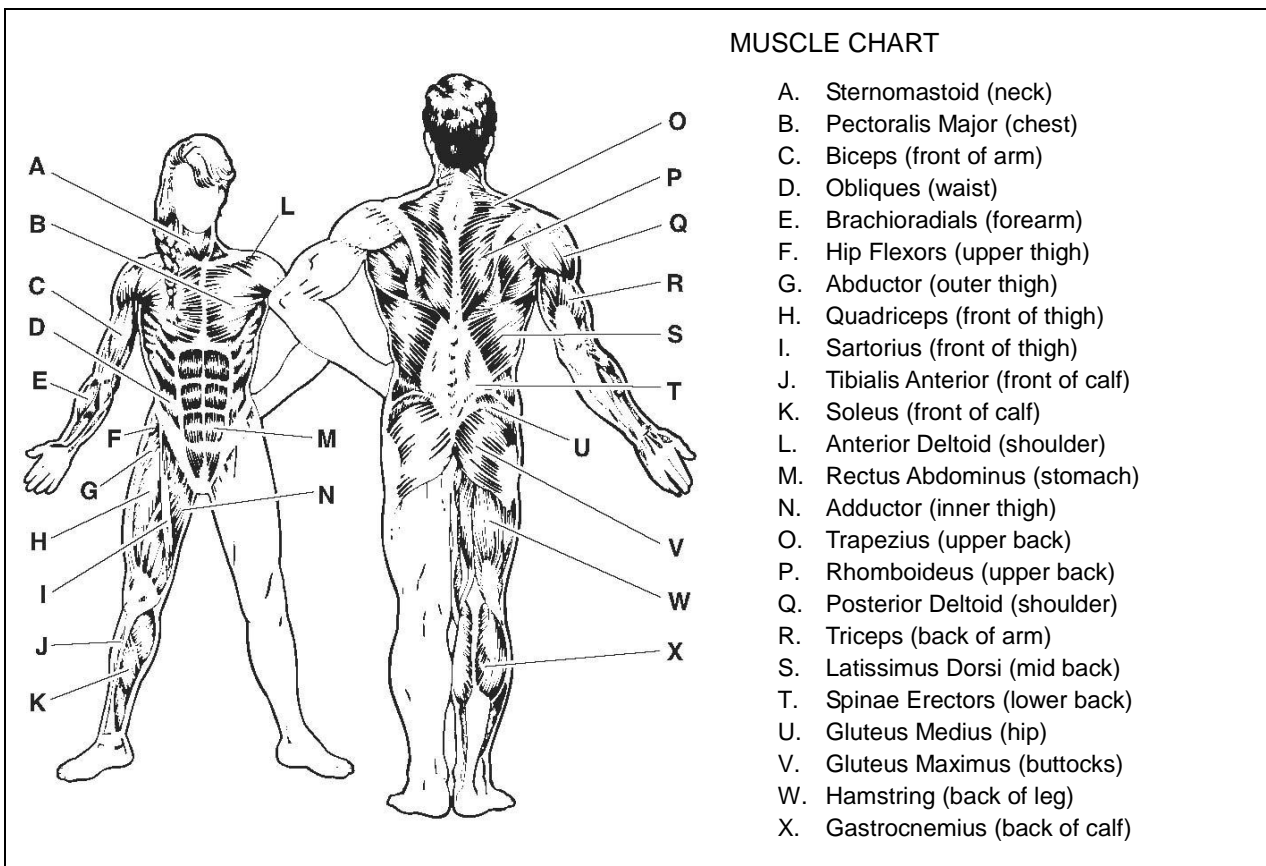

## **MANUFACTURER'S WARRANTY**

This warranty covers your CAP Strength product against defects in materials and workmanship when used for the intended purpose under normal use and conditions, provided that the product receives normal maintenance and care. This warranty lasts for: 1 year on all steel parts; 90 days on other parts; 30 days on vinyl cushions. All of these are for the original owner only. This warranty is not valid in cases where this product is used commercially.

CAP Strength will provide a replacement part at no charge for any part found defective in materials or workmanship during the specified warranty period. Under no circumstances will the manufacturer be responsible for damages or failures that occur as a result of improper assembly or failure to operate the product correctly. This warranty does not cover misuse, neglect, accident, alterations or repairs made by an unauthorized service representative.

## **ARBITRATION**

Use of this product creates an agreement between CAP Strength, Inc. and User of Product to resolve all disputes, claims, or controversies whatsoever arising from or relating to this product, including the validity of this arbitration clause, by binding arbitration pursuant to Section 2 of the Federal Arbitration Act. Maximum judgment for all causes of action shall be limited to \$10,000. The parties agree and understand that by using this product they choose arbitration instead of litigation to resolve disputes. If Buyer(s) choose not to enter into this agreement, they may return unused product for full refund.

※Warranty does not apply outside the continental united states.



Missing a Part or Need Assembly Assistance?  
Do Not RETURN to Store.

Call our Service Line:

**1-877-227-0955**

**Printed in China CAP Barbell Inc.**