

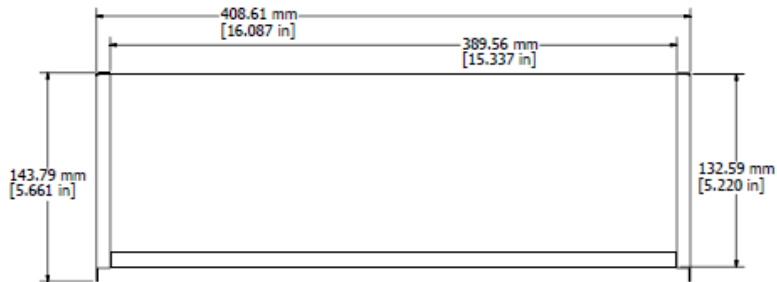

TOP VIEW OF ASSEMBLY



SIDE VIEW OF ASSEMBLY

.91 mm
[.036 in]
TYP. MATERIAL
THICKNESS

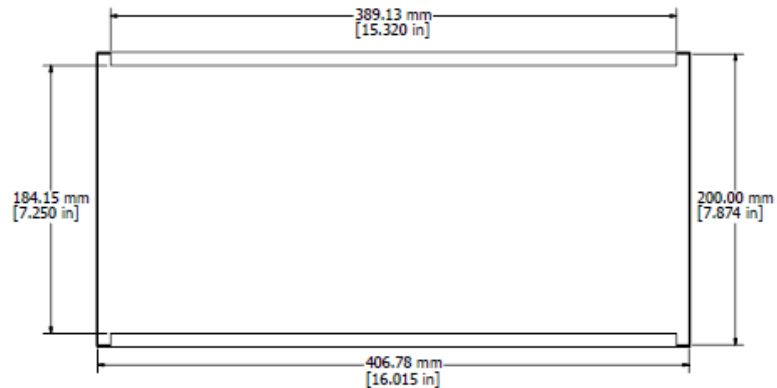

BOTTOM VIEW OF ASSEMBLY

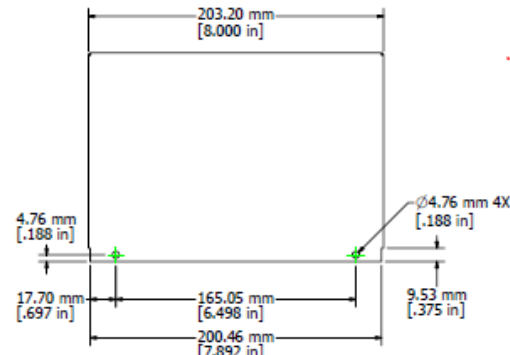
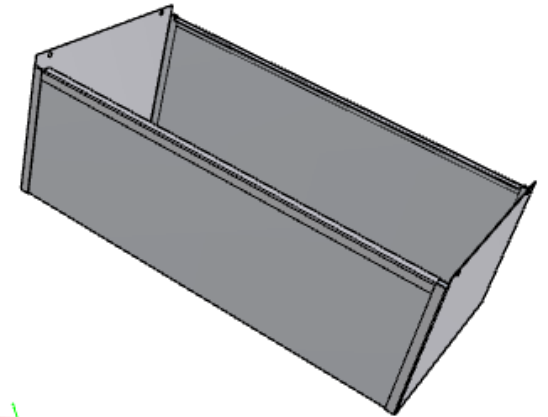

END VIEW OF ASSEMBLY



1451-26
Material: 20ga. Welded Steel, Gray color
Cover: Perforated Steel
Screws: 4 Supplied (#6-32 X 1/4" self tap)
For use with 1441 and 1444 series chassis.