

TL022C, TL022M DUAL LOW-POWER OPERATIONAL AMPLIFIERS

SLOS076 – SEPTEMBER 1973 – REVISED SEPTEMBER 1990

- Very Low Power Consumption
- Power Dissipation With ± 2 -V Supplies
170 μ W Typ
- Low Input Bias and Offset Currents
- Output Short-Circuit Protection
- Low Input Offset Voltage
- Internal Frequency Compensation
- Latch-Up-Free Operation
- Popular Dual Operational Amplifier Pinout

**TL022M IS NOT RECOMMENDED FOR
NEW DESIGNS**

description

The TL022 is a dual low-power operational amplifier designed to replace higher power devices in many applications without sacrificing system performance. High input impedance, low supply currents, and low equivalent input noise voltage over a wide range of operating supply voltages result in an extremely versatile operational amplifier for use in a variety of analog applications including battery-operated circuits. Internal frequency compensation, absence of latch-up, high slew rate, and output short-circuit protection assure ease of use.

The TL022C is characterized for operation from 0°C to 70°C. The TL022M is characterized for operation over the full military temperature range of -55°C to 125°C.

TL022M . . . JG PACKAGE
TL022C . . . D OR P PACKAGE
(TOP VIEW)

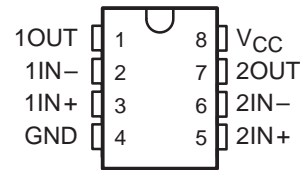

TL022M . . . U PACKAGE
(TOP VIEW)

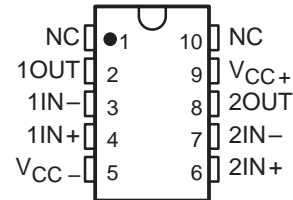

symbol (each amplifier)

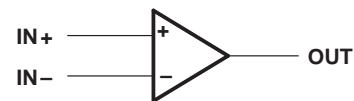

AVAILABLE OPTIONS

T _A	V _{IO} max AT 25°C	PACKAGE			
		SMALL OUTLINE (D)	CERAMIC DIP (JG)	PLASTIC DIP (P)	CERAMIC FLAT PACK (U)
0°C to 70°C	5 mV	TL022CD	—	TL022CP	—
-55°C to 125°C	5 mV	—	TL022MJG	—	TL022MU

The D package is available taped and reeled. Add the suffix R to the device type (i.e. TL022CDR).

TL022C, TL022M DUAL LOW-POWER OPERATIONAL AMPLIFIERS

SLOS076 – SEPTEMBER 1973 – REVISED SEPTEMBER 1990

schematic



absolute maximum ratings over operating free-air temperature range (unless otherwise noted)

	TL022C	TL022M	UNIT
Supply voltage, V_{CC+} (see Note 1)	18	22	V
Supply voltage, V_{CC-} (see Note 1)	-18	-22	V
Differential input voltage (see Note 2)	± 30	± 30	V
Input voltage (any input, see Notes 1 and 3)	± 15	± 15	V
Duration of output short circuit (see Note 4)	unlimited	unlimited	
Continuous total dissipation	See Dissipation Rating Table		
Operating free-air temperature range	0 to 70	-55 to 125	$^{\circ}\text{C}$
Storage temperature range	-65 to 150	-65 to 150	$^{\circ}\text{C}$
Lead temperature 1,6 mm (1/16 inch) from case for 60 seconds	JG or U package	300	$^{\circ}\text{C}$
Lead temperature 1,6 mm (1/16 inch) from case for 10 seconds	D or P package	260	$^{\circ}\text{C}$

- NOTES: 1. All voltage values, unless otherwise noted, are with respect to the midpoint between V_{CC+} and V_{CC-} .
 2. Differential voltages are at $\text{IN}+$ with respect to $\text{IN}-$.
 3. The magnitude of the input voltage must never exceed the magnitude of the supply voltage or 15 V, whichever is less.
 4. The output may be shorted to ground or either power supply. For the TL022M only, the unlimited duration of the short circuit applies at (or below) 125 $^{\circ}\text{C}$ case temperature or 75 $^{\circ}\text{C}$ free-air temperature.

DISSIPATION RATING TABLE

PACKAGE	$T_A \leq 25^{\circ}\text{C}$ POWER RATING	DERATING FACTOR	DERATE ABOVE T_A	$T_A = 70^{\circ}\text{C}$ POWER RATING	$T_A = 125^{\circ}\text{C}$ POWER RATING
D	680 mW	5.8 mW/ $^{\circ}\text{C}$	33 $^{\circ}\text{C}$	464 mW	—
JG	680 mW	8.4 mW/ $^{\circ}\text{C}$	69 $^{\circ}\text{C}$	672 mW	210 mW
P	680 mW	8.0 mW/ $^{\circ}\text{C}$	65 $^{\circ}\text{C}$	640 mW	—
U	675 mW	5.4 mW/ $^{\circ}\text{C}$	25 $^{\circ}\text{C}$	432 mW	135 mW



POST OFFICE BOX 655303 • DALLAS, TEXAS 75265

TL022C, TL022M DUAL LOW-POWER OPERATIONAL AMPLIFIERS

SLOS076 – SEPTEMBER 1973 – REVISED SEPTEMBER 1990

recommended operating conditions

	MIN	MAX	UNIT
Supply voltage, V_{CC+}	5	15	V
Supply voltage, V_{CC-}	-5	-15	V

electrical characteristics at specified free-air temperature, $V_{CC\pm} = \pm 15$ V (unless otherwise noted)

PARAMETER	TEST CONDITIONS†	TL022C			TL022M			UNIT
		MIN	TYP	MAX	MIN	TYP	MAX	
V_{IO} Input offset voltage	$V_O = 0$, $R_S = 50 \Omega$	25°C	1	5	1	5	mV	
		Full range		7.5		6		
I_{IO} Input offset current	$V_O = 0$	25°C	15	80	5	40	nA	
		Full range		200		100		
I_{IB} Input bias current	$V_O = 0$	25°C	100	250	50	100	nA	
		Full range		400		250		
V_{ICR} Common-mode input voltage range		25°C	± 12	± 13	± 12	± 13	V	
		Full range	± 12		± 12			
$V_{O(PP)}$ Maximum peak-to-peak output voltage swing	$R_L = 10 \text{ k}\Omega$	25°C	20	26	20	26	V	
	$R_L \geq 10 \text{ k}\Omega$	Full range	20		20			
A_{VD} Large-signal differential voltage amplification	$R_L \geq 10 \text{ k}\Omega$, $V_O = \pm 10 \text{ V}$	25°C	60	80	72	86	dB	
		Full range	60		66			
B_1 Unity-gain bandwidth		25°C	0.5		0.5		MHz	
CMRR Common-mode rejection ratio	$V_{IC} = V_{ICRmin}$, $R_S = 50 \Omega$	25°C	60	72	60	72	dB	
		Full range	60		60			
k_{SVS} Supply voltage sensitivity ($\Delta V_{IO}/\Delta V_{CC}$)	$V_{CC} = \pm 9 \text{ V to } \pm 15 \text{ V}$, $R_S = 50 \Omega$	25°C	30	200	30	150	$\mu\text{V/V}$	
		Full range		200		150		
V_n Equivalent input noise voltage	$A_{VD} = 20 \text{ dB}$, $B = 1 \text{ Hz}$, $f = 1 \text{ kHz}$	25°C	50		50		nV/Hz	
I_{OS} Short-circuit output current		25°C	± 6		± 6		mA	
I_{CC} Supply current (both amplifiers)	$V_O = 0$, No load	25°C	130	250	130	250	μA	
		Full range		250		250		
P_D Total dissipation (both amplifiers)	$V_O = 0$, No load	25°C	3.9	7.5	3.9	6	mW	
		Full range		7.5		6		

† All characteristics are measured under open-loop conditions with zero common-mode input voltage unless otherwise specified. Full range for TL022C is 0°C to 70°C and for TL022M is -55°C to 125°C.

operating characteristics, $V_{CC\pm} = \pm 15$ V, $T_A = 25^\circ\text{C}$

PARAMETER	TEST CONDITIONS	MIN	TYP	MAX	UNIT
t_r Rise time	$V_I = 20 \text{ mV}$, $R_L = 10 \text{ k}\Omega$, $C_L = 100 \text{ pF}$, See Figure 1		0.3		μs
Overshoot factor			5%		
SR Slew rate at unity gain	$V_I = 10 \text{ V}$, $R_L = 10 \text{ k}\Omega$, $C_L = 100 \text{ pF}$, See Figure 1		0.5		V/ μs



TL022C, TL022M DUAL LOW-POWER OPERATIONAL AMPLIFIERS

SLOS076 – SEPTEMBER 1973 – REVISED SEPTEMBER 1990

PARAMETER MEASUREMENT INFORMATION

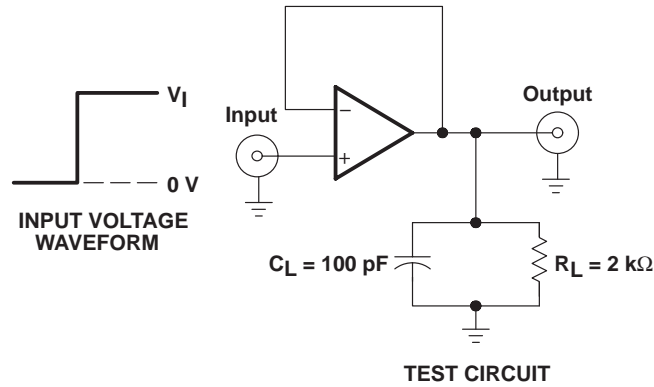

Figure 1. Rise Time, Overshoot Factor, and Slew Rate

TYPICAL CHARACTERISTICS

TOTAL POWER DISSIPATION
vs
SUPPLY RATE

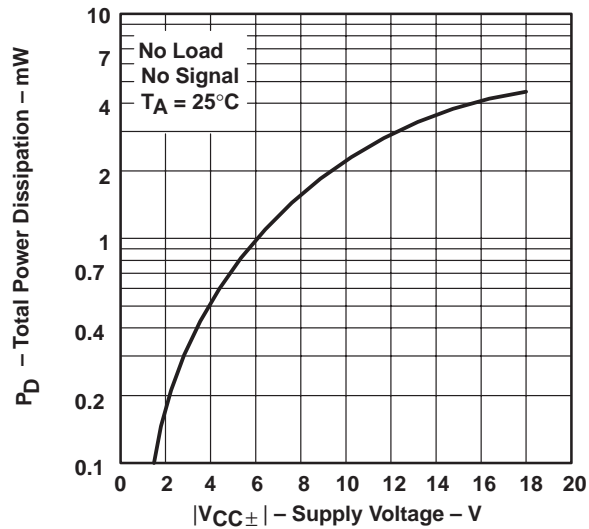

Figure 2

PACKAGING INFORMATION

Orderable Device	Status (1)	Package Type	Package Drawing	Pins	Package Qty	Eco Plan (2)	Lead finish/ Ball material (6)	MSL Peak Temp (3)	Op Temp (°C)	Device Marking (4/5)	Samples
TL022CD	ACTIVE	SOIC	D	8	75	RoHS & Green	NIPDAU	Level-1-260C-UNLIM	0 to 70	TL022C	Samples
TL022CDR	ACTIVE	SOIC	D	8	2500	RoHS & Green	NIPDAU	Level-1-260C-UNLIM	0 to 70	TL022C	Samples
TL022CDR	ACTIVE	SOIC	D	8	2500	RoHS & Green	NIPDAU	Level-1-260C-UNLIM	0 to 70	TL022C	Samples
TL022CDR	ACTIVE	SOIC	D	8	2500	RoHS & Green	NIPDAU	Level-1-260C-UNLIM	0 to 70	TL022C	Samples
TL022CDRG4	ACTIVE	SOIC	D	8	2500	RoHS & Green	NIPDAU	Level-1-260C-UNLIM	0 to 70	TL022C	Samples
TL022CDRG4	ACTIVE	SOIC	D	8	2500	RoHS & Green	NIPDAU	Level-1-260C-UNLIM	0 to 70	TL022C	Samples
TL022CDRG4	ACTIVE	SOIC	D	8	2500	RoHS & Green	NIPDAU	Level-1-260C-UNLIM	0 to 70	TL022C	Samples
TL022CP	ACTIVE	PDIP	P	8	50	RoHS & Green	NIPDAU	N / A for Pkg Type	0 to 70	TL022CP	Samples
TL022CP	ACTIVE	PDIP	P	8	50	RoHS & Green	NIPDAU	N / A for Pkg Type	0 to 70	TL022CP	Samples
TL022CP	ACTIVE	PDIP	P	8	50	RoHS & Green	NIPDAU	N / A for Pkg Type	0 to 70	TL022CP	Samples
TL022CPSR	ACTIVE	SO	PS	8	2000	RoHS & Green	NIPDAU	Level-1-260C-UNLIM	0 to 70	T022	Samples
TL022CPSR	ACTIVE	SO	PS	8	2000	RoHS & Green	NIPDAU	Level-1-260C-UNLIM	0 to 70	T022	Samples
TL022CPSR	ACTIVE	SO	PS	8	2000	RoHS & Green	NIPDAU	Level-1-260C-UNLIM	0 to 70	T022	Samples
TL022CPSRG4	ACTIVE	SO	PS	8	2000	RoHS & Green	NIPDAU	Level-1-260C-UNLIM	0 to 70	T022	Samples
TL022CPSRG4	ACTIVE	SO	PS	8	2000	RoHS & Green	NIPDAU	Level-1-260C-UNLIM	0 to 70	T022	Samples
TL022CPSRG4	ACTIVE	SO	PS	8	2000	RoHS & Green	NIPDAU	Level-1-260C-UNLIM	0 to 70	T022	Samples

(1) The marketing status values are defined as follows:

ACTIVE: Product device recommended for new designs.

LIFEBUY: TI has announced that the device will be discontinued, and a lifetime-buy period is in effect.

NRND: Not recommended for new designs. Device is in production to support existing customers, but TI does not recommend using this part in a new design.

PREVIEW: Device has been announced but is not in production. Samples may or may not be available.

OBSELETE: TI has discontinued the production of the device.

(2) **RoHS:** TI defines "RoHS" to mean semiconductor products that are compliant with the current EU RoHS requirements for all 10 RoHS substances, including the requirement that RoHS substance do not exceed 0.1% by weight in homogeneous materials. Where designed to be soldered at high temperatures, "RoHS" products are suitable for use in specified lead-free processes. TI may reference these types of products as "Pb-Free".

RoHS Exempt: TI defines "RoHS Exempt" to mean products that contain lead but are compliant with EU RoHS pursuant to a specific EU RoHS exemption.

Green: TI defines "Green" to mean the content of Chlorine (Cl) and Bromine (Br) based flame retardants meet JS709B low halogen requirements of ≤ 1000 ppm threshold. Antimony trioxide based flame retardants must also meet the ≤ 1000 ppm threshold requirement.

(3) MSL, Peak Temp. - The Moisture Sensitivity Level rating according to the JEDEC industry standard classifications, and peak solder temperature.

(4) There may be additional marking, which relates to the logo, the lot trace code information, or the environmental category on the device.

(5) Multiple Device Markings will be inside parentheses. Only one Device Marking contained in parentheses and separated by a "~" will appear on a device. If a line is indented then it is a continuation of the previous line and the two combined represent the entire Device Marking for that device.

(6) Lead finish/Ball material - Orderable Devices may have multiple material finish options. Finish options are separated by a vertical ruled line. Lead finish/Ball material values may wrap to two lines if the finish value exceeds the maximum column width.

Important Information and Disclaimer: The information provided on this page represents TI's knowledge and belief as of the date that it is provided. TI bases its knowledge and belief on information provided by third parties, and makes no representation or warranty as to the accuracy of such information. Efforts are underway to better integrate information from third parties. TI has taken and continues to take reasonable steps to provide representative and accurate information but may not have conducted destructive testing or chemical analysis on incoming materials and chemicals. TI and TI suppliers consider certain information to be proprietary, and thus CAS numbers and other limited information may not be available for release.

In no event shall TI's liability arising out of such information exceed the total purchase price of the TI part(s) at issue in this document sold by TI to Customer on an annual basis.

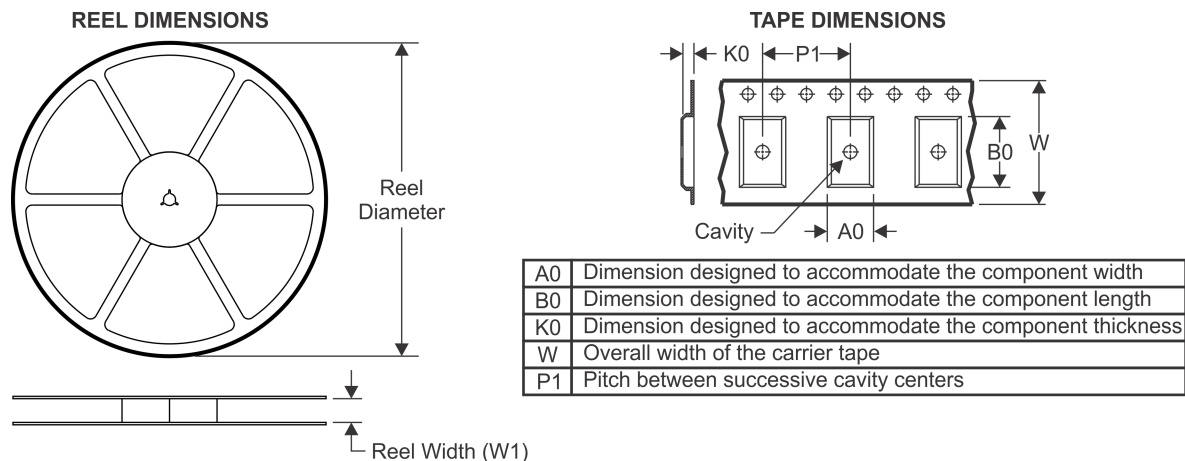
TAPE AND REEL INFORMATION

QUADRANT ASSIGNMENTS FOR PIN 1 ORIENTATION IN TAPE

*All dimensions are nominal

Device	Package Type	Package Drawing	Pins	SPQ	Reel Diameter (mm)	Reel Width W1 (mm)	A0 (mm)	B0 (mm)	K0 (mm)	P1 (mm)	W (mm)	Pin1 Quadrant
TL022CDR	SOIC	D	8	2500	330.0	12.4	6.4	5.2	2.1	8.0	12.0	Q1
TL022CPSR	SO	PS	8	2000	330.0	16.4	8.35	6.6	2.4	12.0	16.0	Q1

TAPE AND REEL BOX DIMENSIONS

*All dimensions are nominal

Device	Package Type	Package Drawing	Pins	SPQ	Length (mm)	Width (mm)	Height (mm)
TL022CDR	SOIC	D	8	2500	340.5	336.1	25.0
TL022CPSR	SO	PS	8	2000	853.0	449.0	35.0

TUBE

*All dimensions are nominal

Device	Package Name	Package Type	Pins	SPQ	L (mm)	W (mm)	T (μm)	B (mm)
TL022CD	D	SOIC	8	75	507	8	3940	4.32
TL022CP	P	PDIP	8	50	506	13.97	11230	4.32



D0008A

PACKAGE OUTLINE

SOIC - 1.75 mm max height

SMALL OUTLINE INTEGRATED CIRCUIT



4214825/C 02/2019

NOTES:

1. Linear dimensions are in inches [millimeters]. Dimensions in parenthesis are for reference only. Controlling dimensions are in inches. Dimensioning and tolerancing per ASME Y14.5M.
2. This drawing is subject to change without notice.
3. This dimension does not include mold flash, protrusions, or gate burrs. Mold flash, protrusions, or gate burrs shall not exceed .006 [0.15] per side.
4. This dimension does not include interlead flash.
5. Reference JEDEC registration MS-012, variation AA.

EXAMPLE BOARD LAYOUT

D0008A

SOIC - 1.75 mm max height

SMALL OUTLINE INTEGRATED CIRCUIT



LAND PATTERN EXAMPLE
EXPOSED METAL SHOWN
SCALE:8X



SOLDER MASK DETAILS

4214825/C 02/2019

NOTES: (continued)

6. Publication IPC-7351 may have alternate designs.

7. Solder mask tolerances between and around signal pads can vary based on board fabrication site.

EXAMPLE STENCIL DESIGN

D0008A

SOIC - 1.75 mm max height

SMALL OUTLINE INTEGRATED CIRCUIT



SOLDER PASTE EXAMPLE
BASED ON .005 INCH [0.125 MM] THICK STENCIL
SCALE:8X

4214825/C 02/2019

NOTES: (continued)

8. Laser cutting apertures with trapezoidal walls and rounded corners may offer better paste release. IPC-7525 may have alternate design recommendations.
9. Board assembly site may have different recommendations for stencil design.

MECHANICAL DATA

PS (R-PDSO-G8)

PLASTIC SMALL-OUTLINE PACKAGE



- NOTES:
- A. All linear dimensions are in millimeters.
 - B. This drawing is subject to change without notice.
 - C. Body dimensions do not include mold flash or protrusion, not to exceed 0,15.

PS (R-PDSO-G8)

PLASTIC SMALL OUTLINE

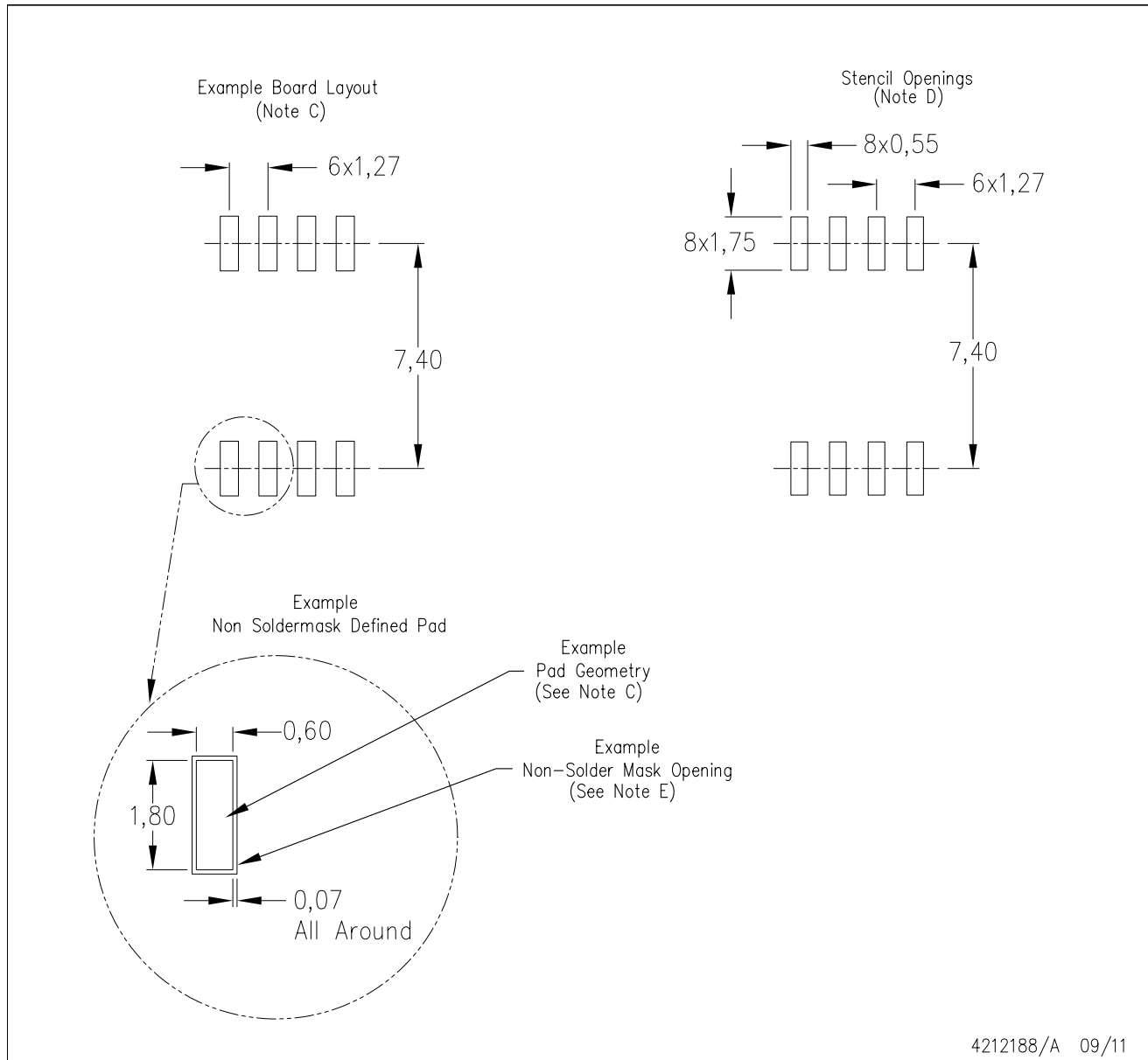

- NOTES:
- A. All linear dimensions are in millimeters.
 - B. This drawing is subject to change without notice.
 - C. Publication IPC-7351 is recommended for alternate designs.
 - D. Laser cutting apertures with trapezoidal walls and also rounding corners will offer better paste release. Customers should contact their board assembly site for stencil design recommendations. Refer to IPC-7525 for other stencil recommendations.
 - E. Customers should contact their board fabrication site for solder mask tolerances between and around signal pads.

P (R-PDIP-T8)

PLASTIC DUAL-IN-LINE PACKAGE



- NOTES:
- A. All linear dimensions are in inches (millimeters).
 - B. This drawing is subject to change without notice.
 - C. Falls within JEDEC MS-001 variation BA.

IMPORTANT NOTICE AND DISCLAIMER

TI PROVIDES TECHNICAL AND RELIABILITY DATA (INCLUDING DATA SHEETS), DESIGN RESOURCES (INCLUDING REFERENCE DESIGNS), APPLICATION OR OTHER DESIGN ADVICE, WEB TOOLS, SAFETY INFORMATION, AND OTHER RESOURCES "AS IS" AND WITH ALL FAULTS, AND DISCLAIMS ALL WARRANTIES, EXPRESS AND IMPLIED, INCLUDING WITHOUT LIMITATION ANY IMPLIED WARRANTIES OF MERCHANTABILITY, FITNESS FOR A PARTICULAR PURPOSE OR NON-INFRINGEMENT OF THIRD PARTY INTELLECTUAL PROPERTY RIGHTS.

These resources are intended for skilled developers designing with TI products. You are solely responsible for (1) selecting the appropriate TI products for your application, (2) designing, validating and testing your application, and (3) ensuring your application meets applicable standards, and any other safety, security, regulatory or other requirements.

These resources are subject to change without notice. TI grants you permission to use these resources only for development of an application that uses the TI products described in the resource. Other reproduction and display of these resources is prohibited. No license is granted to any other TI intellectual property right or to any third party intellectual property right. TI disclaims responsibility for, and you will fully indemnify TI and its representatives against, any claims, damages, costs, losses, and liabilities arising out of your use of these resources.

TI's products are provided subject to [TI's Terms of Sale](#) or other applicable terms available either on ti.com or provided in conjunction with such TI products. TI's provision of these resources does not expand or otherwise alter TI's applicable warranties or warranty disclaimers for TI products.

TI objects to and rejects any additional or different terms you may have proposed.

Mailing Address: Texas Instruments, Post Office Box 655303, Dallas, Texas 75265
Copyright © 2022, Texas Instruments Incorporated