

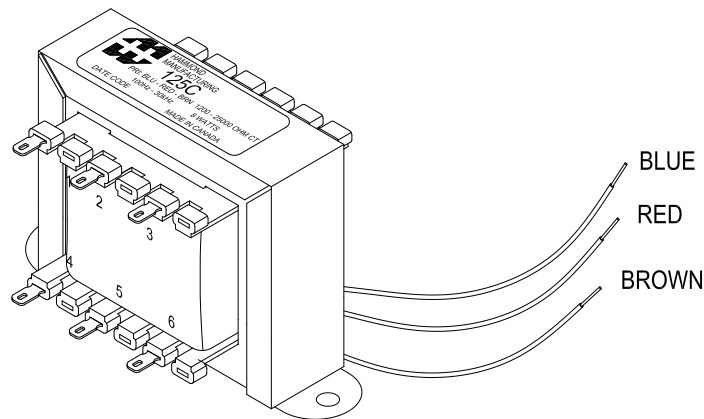

# 125C

## UNIVERSAL PUSH-PULL "CLASSIC" TUBE OUTPUT TRANSFORMER

- ) Designed for general purpose or replacement use in push-pull tube output circuits.
- ) For single ended use, see our [125SE Series](#).
- ) Frequency response: 150 Hz. - 15 KHz at full rated power (+/- 1db max. ref. 1 KHz) also see graphs for more detailed response data
- ) Open style with minimum 5" long primary leads.
- ) Secondary solder lugs for convenient secondary connections (except 125B - uses minimum 5" secondary leads).
- ) Primary impedances from 1,200 to 25,000 Ohms. (For the full range of impedances see page 6)
- ) Secondary impedances from 1.5 to 15 Ohms. Designed for general purpose or replacement use (not Hi-Fi), in single ended, tube output circuits.



ALL LEADS MIN. 6" OUT

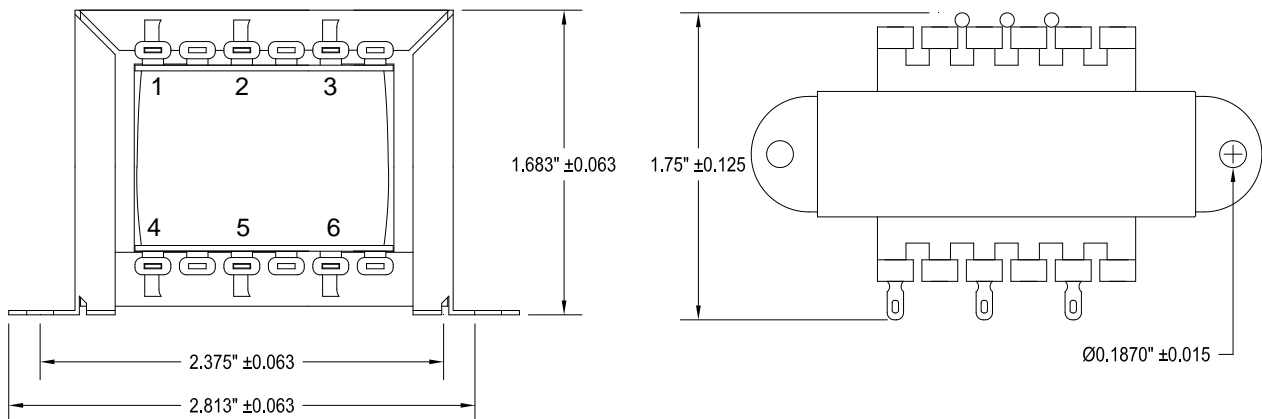

**ELECTRICAL SPECIFICATIONS\*\***

<b>Characteristic</b>	<b>Typical</b>
Input Impedance	1200 - 25000 $\varnothing$
Output Impedance	1.5 - 15 $\varnothing$
Output Power	8 Watts
<b>Primary - DCR</b>	
Blue - Brown	285 $\varnothing$
<b>Secondary DCR</b>	
1 - 2	137 m $\varnothing$
1 - 3	299 m $\varnothing$
1 - 4	470 m $\varnothing$
1 - 5	670 m $\varnothing$
1 - 6	890 m $\varnothing$
<b>Inductance</b> @ 1.0 kHz, 1.0 V OC	
Primary - Blue - Brown	4.40 Hy
Sec - 1 - 2	0.24 mH
Sec - 1 - 3	1.29 mH
Sec - 1 - 4	3.33 mH
Sec - 1 - 5	7.27 mH
Sec - 1 - 6	13.24 mH
<b>Impedance</b> @ 1.0 kHz, 1.0 V OC	
Primary - Blue - Brown	25.5 K $\varnothing$
Sec - 1 - 2	1.76 $\varnothing$
Sec - 1 - 3	10.75 $\varnothing$
Sec - 1 - 4	29.3 $\varnothing$
Sec - 1 - 5	66.2 $\varnothing$
Sec - 1 - 6	121.5 $\varnothing$
Frequency Response	See graphs for specific response, Typ. $\downarrow$ 1.0db from 100Hz to 15KHz
Dielectric Strength	1500Vrms
Temperature Range	-40 To 105°C

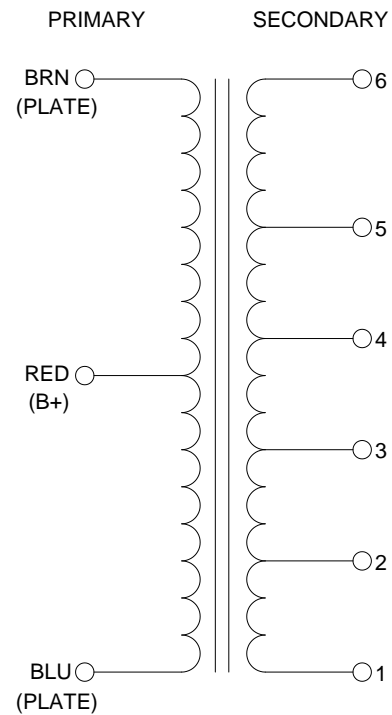
**Schematic and Hook Up Data**

\*FOR FULL IMPEDANCE TABLE SEE PAGE 6

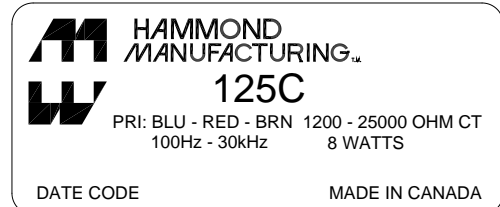

### 125C Frequency Response 2 ohm Output

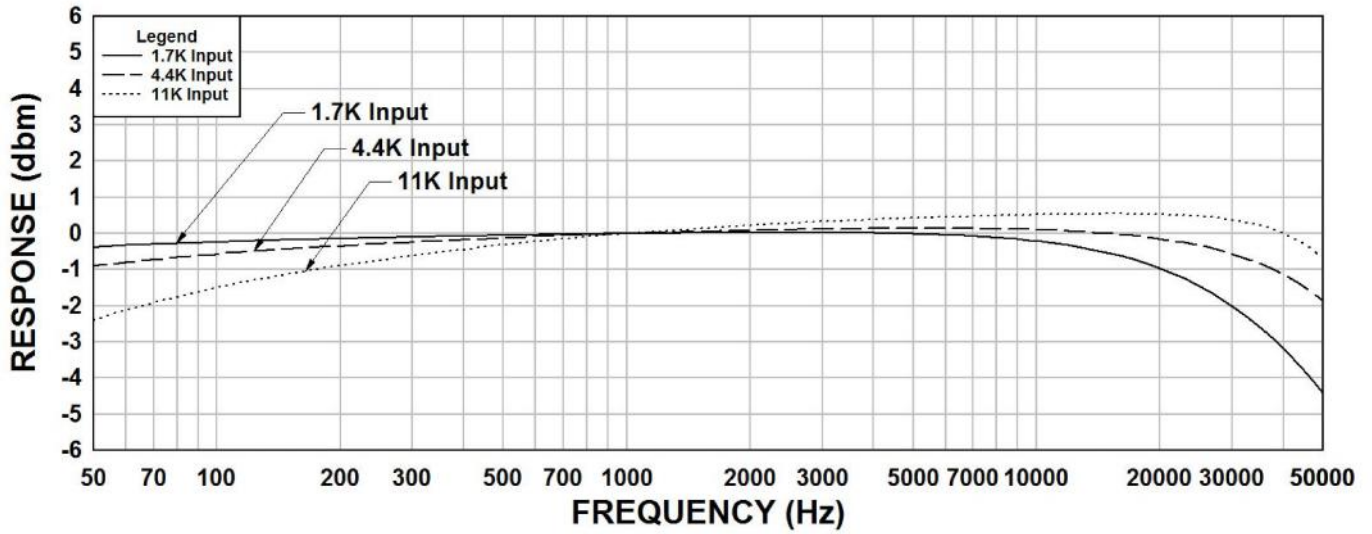

### 125C Frequency Response 4 ohm Output

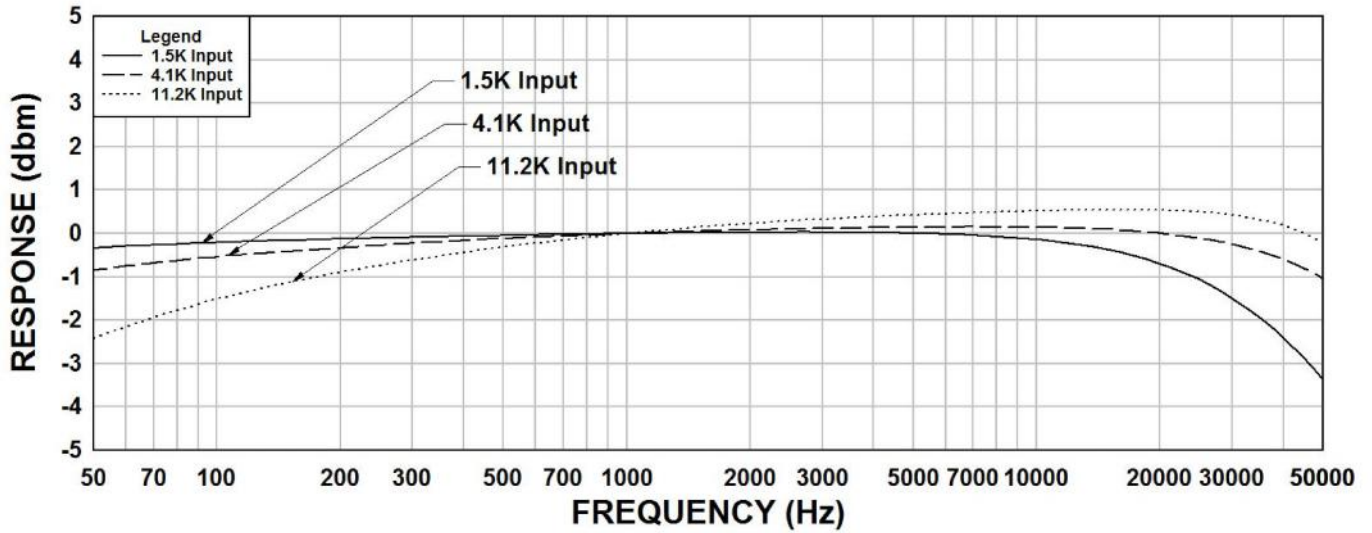

### 125C Frequency Response 8 ohm Output

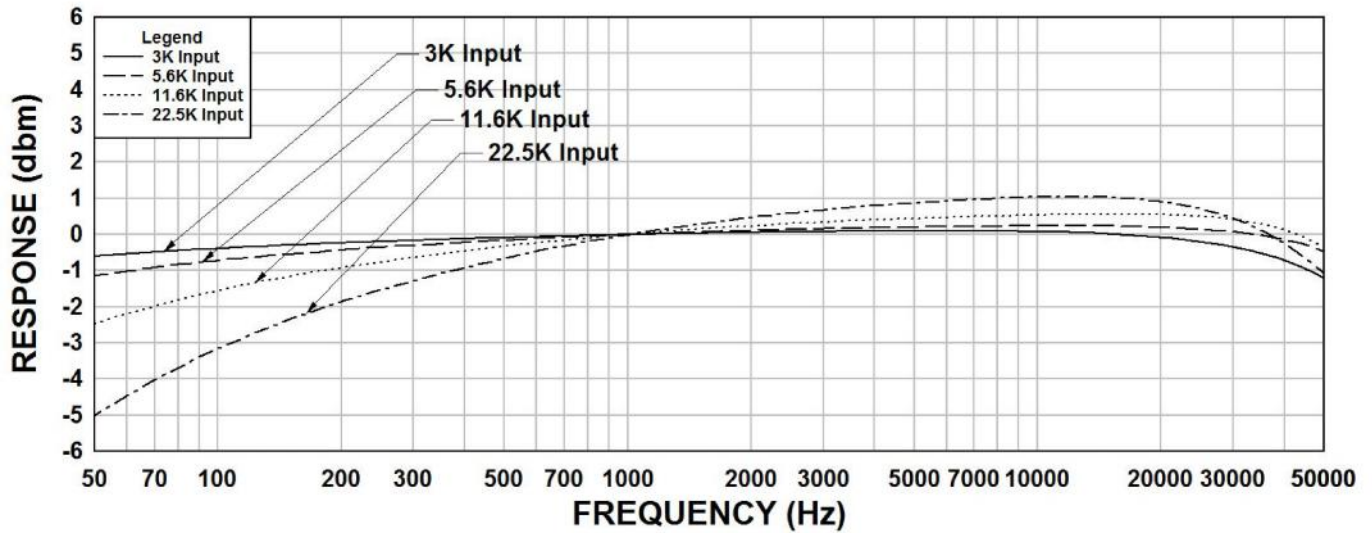

### 125C THD+N 2 ohm Output

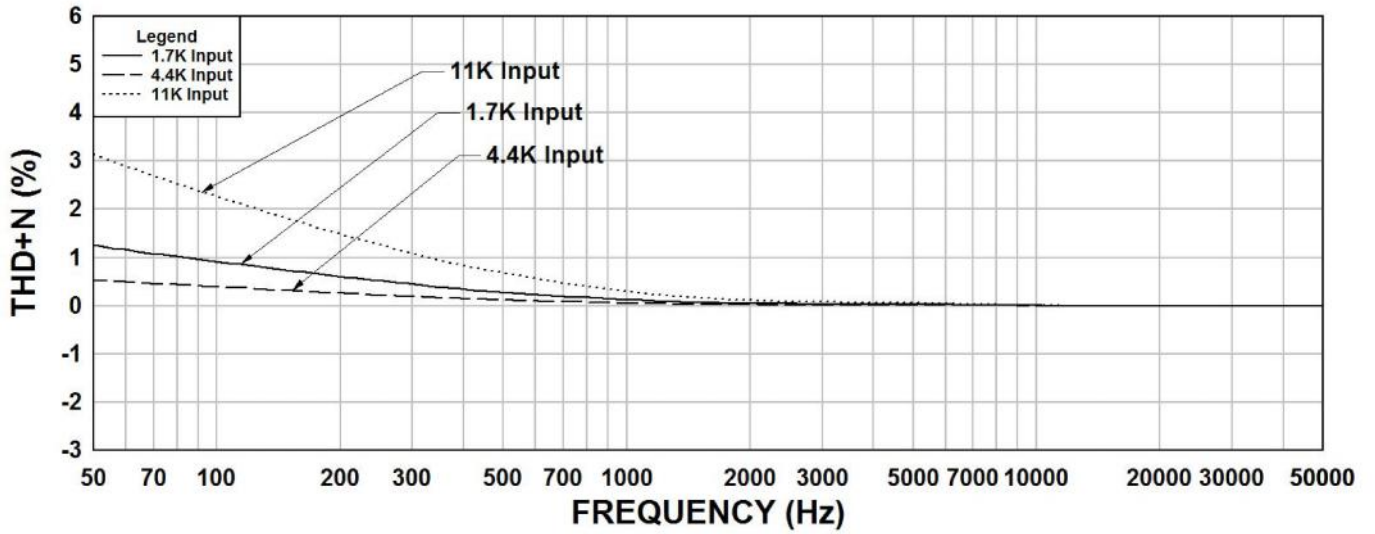

### 125C THD+N 4 ohm Output

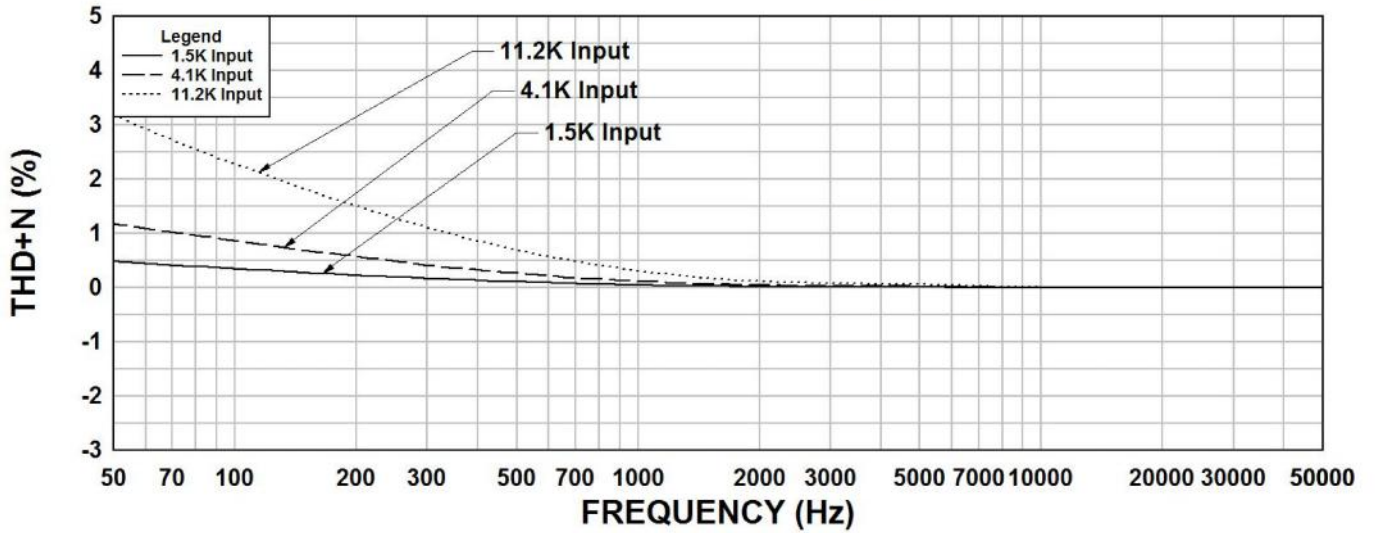

### 125C THD+N 8 ohm Output

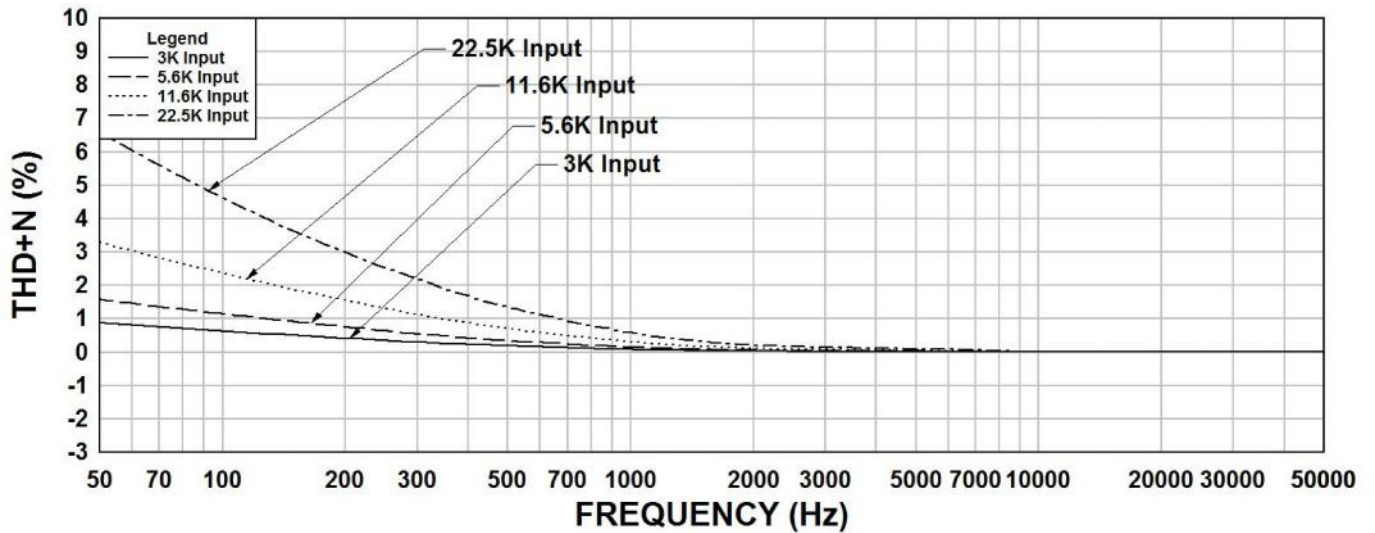

### 125C Phase Shift 2 ohm Output

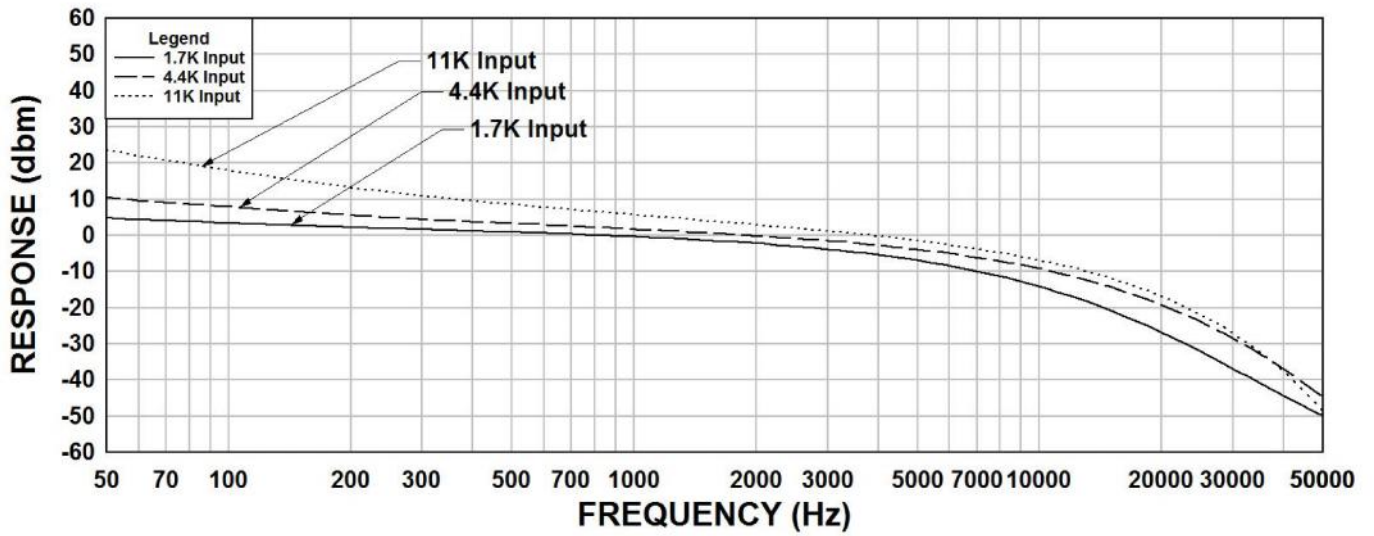

### 125C Phase Shift 4 ohm Output

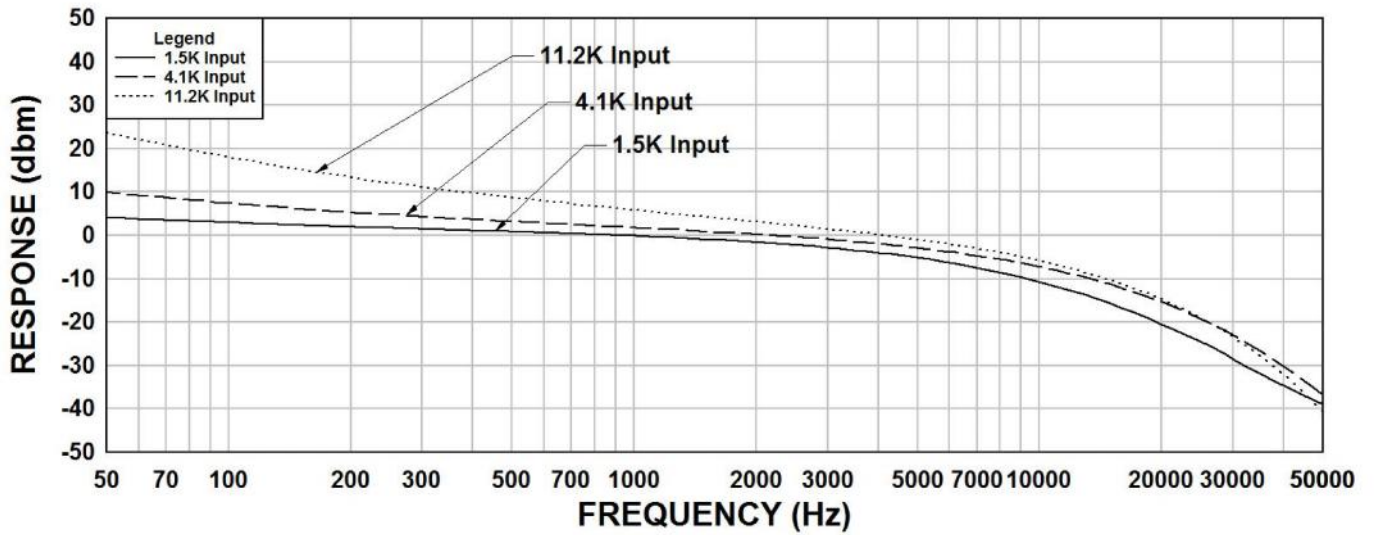

### 125C Phase Shift 8 ohm Output

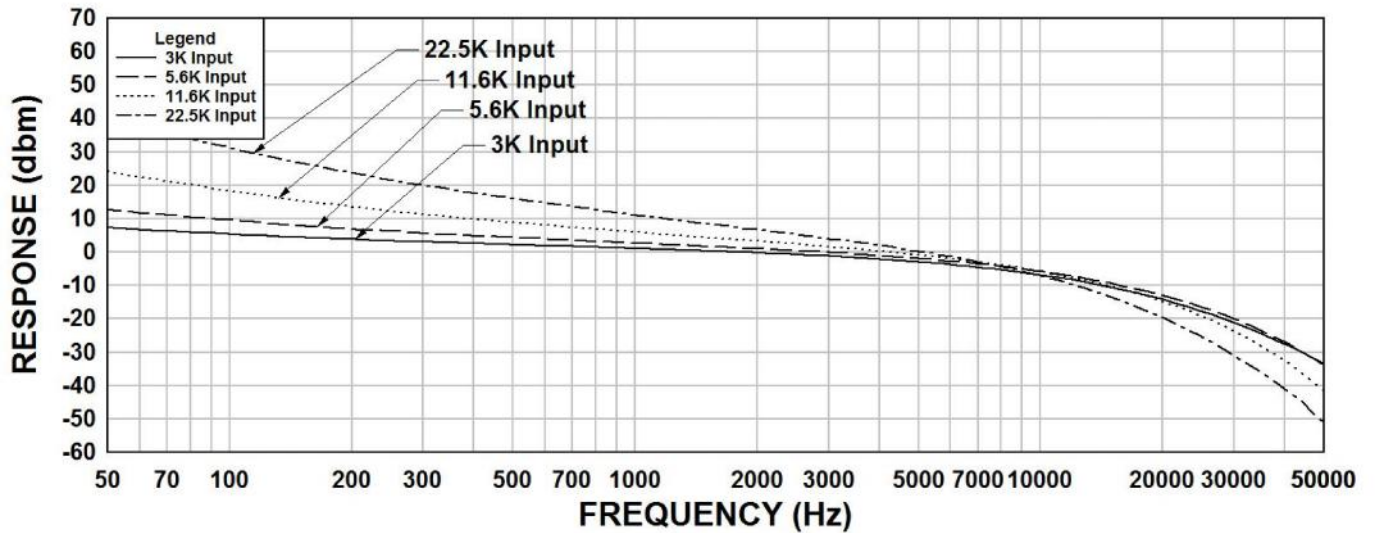

## Hook-Up Data

Connect Speaker To	Voice Coil Impedance (Ohms)							
	1.5	2	3.2	4	6	8	12	15
(Secondary Lugs)	Resulting Total Primary Impedance (Below), Blue Wire to Brown Wire (Ohms)							
1 & 2	27000	-	-	-	-	-	-	-
2 & 3	18000	24000	-	-	-	-	-	-
3 & 4	16500	22000	-	-	-	-	-	-
4 & 5	10000	13500	21600	27000	-	-	-	-
5 & 6	8500	11000	18000	22000	-	-	-	-
1 & 3	5400	7200	11500	15000	21600	-	-	-
2 & 4	4200	5600	9000	11200	16800	22500	-	-
3 & 5	3300	4400	7000	8800	13200	17600	26400	-
4 & 6	2400	3200	5100	6400	9600	12800	19200	24000
1 & 4	2150	2900	4600	5800	8700	11600	17400	21500
2 & 5	1550	2050	3300	4100	6150	8200	12300	15500
3 & 6	1300	1700	2700	3400	5100	6800	10200	12800
1 & 5	-	1400	2200	2800	4200	5600	8400	10200
2 & 6	-	-	1700	2100	3150	4200	6300	8000
1 & 6	-	-	1200	1500	2300	3000	4500	5600

## TYPICAL TEST CIRCUIT

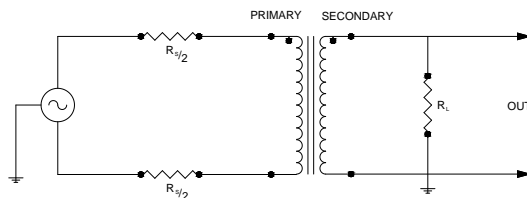

Measurement instruments  
 Hp4192a impedance analyzer  
 Hp3456a DVM  
 Keithley 2002 DVM  
 D scope series iii audio analyzer  
 Wayne Kerr 3255B with a 3265B

\* All graphs input level 20dbu.

\*\* The results are typical and are subject to normal manufacturing and electrical tolerances.

This drawing and the information in it is the property of Hammond Manufacturing. It may not be reproduced, transmitted or used in any manner whatsoever without the written permission of Hammond Manufacturing. Data subject to change without notice.