

LT20BU

LT – Terminals are bent Long Towards Spindle

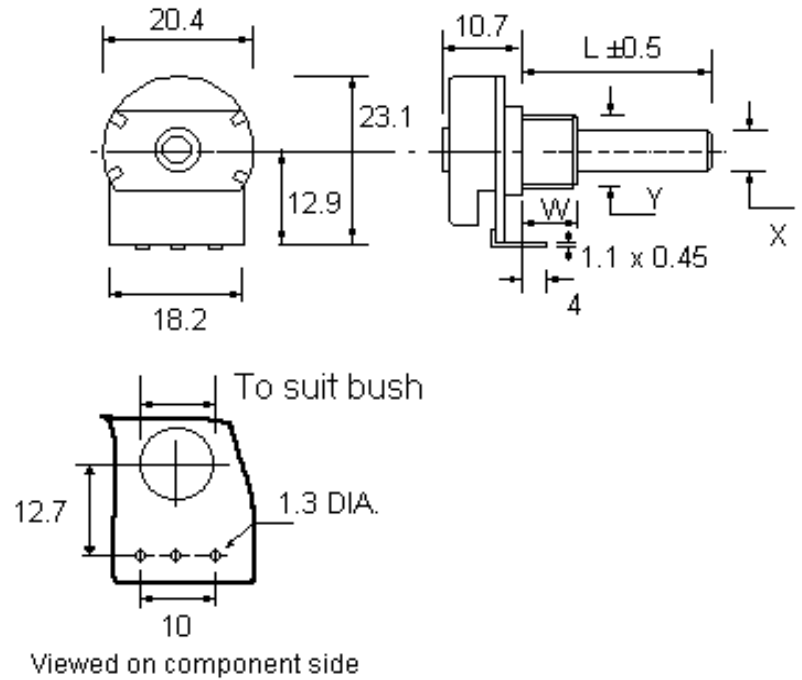

SPINDLE END VIEW

- W Mounting Height
- Y Mounting Diameter
- X Spindle Diameter
- L Spindle Length
- A Initial Termination
- S Wiper (or moving contact) termination
- E End Termination

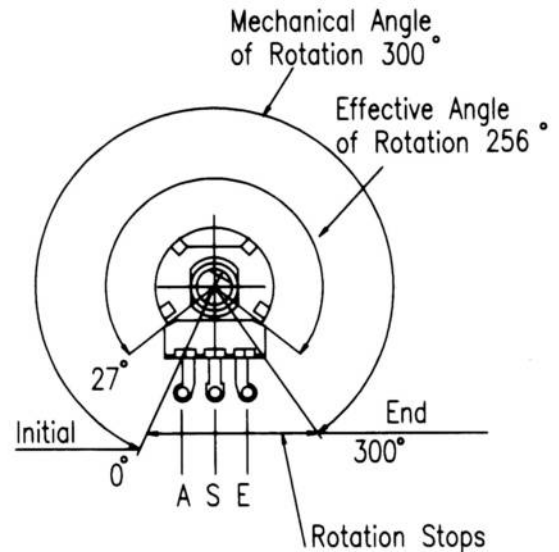

Total mechanical and effective electrical angles of rotation of potentiometers without rotary switch

Technical Data

Rated Power Dissipation @40°C for P20 potentiometers:

0.4W linear law

0.2W nonlinear law

Conductive polymer (plastic) track (over twice the life of carbon tracks)

Effective rotation: 256° nominal

Operating Torque: 0.4 – 1.5 cN.m

Permissible Axial Spindle Load: 100 N (5 Sec. maximum)

Permissible Torque at End Stop: 80 cN.m

Rotation angle: 300° ±5°

Optional Click stop (indents) for rotational tactile feedback

Rotational torque of spindle can be made high or low

Life Expectancy of >20,000 cycles (tested at 30 times per minute)

Insulation Resistance: >= 4 Gohms

Rated Resistance: E3 Series

Optional: E6 Series

Linear Law: 1K – 1M (±10%)

Nonlinear Law: 4K7 – 470K

ELECTRICAL SPECIFICATION COMMON TO ALL POTENTIOMETERS

Conductive polymer (plastic) track (over twice the life of carbon tracks)

Life Expectancy of >20,000 cycles (tested at 30 times per minute)

Insulation Resistance: >= 4 Gohms

Rated Resistance: E3 Series

- Optional: E6 Series
- Linear Law: 1K - 1M
- Nonlinear Law: 4K7 - 470K

Tolerance on Rated Resistance: ± 20%

- Optional Tolerance on 1K - 1M: ± 10%

Resistance Laws (Taper):

- Linear: A
- Nonlinear: B - Log (Audio) or C - Antilog (Reverse Audio)
- Other laws: Please refer to Sales office

ELECTRICAL SPECIFICATION UNIQUE TO P20 POTENTIOMETERS

Effective rotation:

- Without a switch: 256° nominal
- With switch: 243° nominal
- With rotary switch: 243° nominal

Rated Power Dissipation @40°C for P20 potentiometers:

- 0.4W linear law
- 0.2W nonlinear law

P20 power dissipating curve

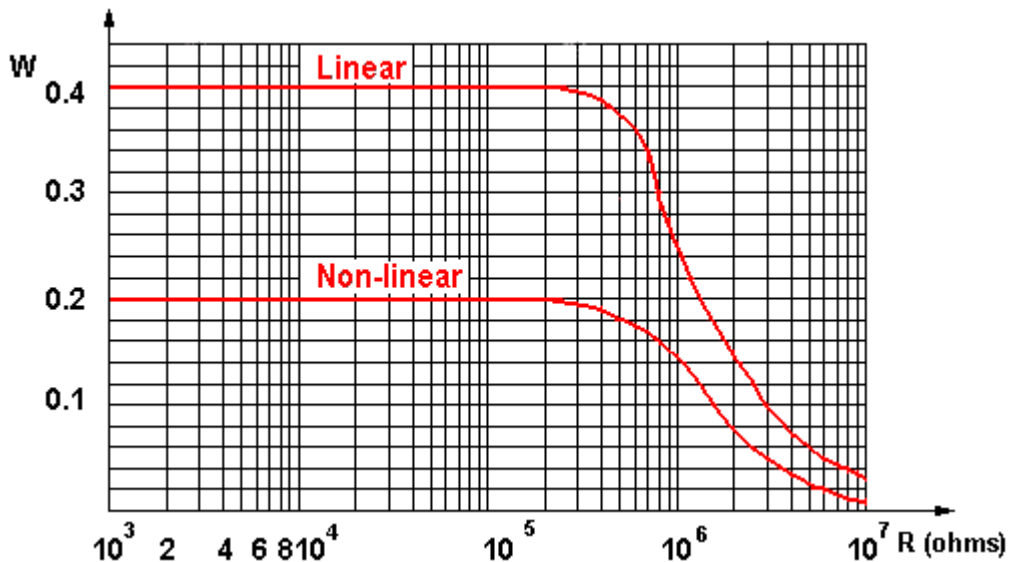

Limiting Element Voltage: 500 V DC for 20mm potentiometers

P20 maximum working voltage curve

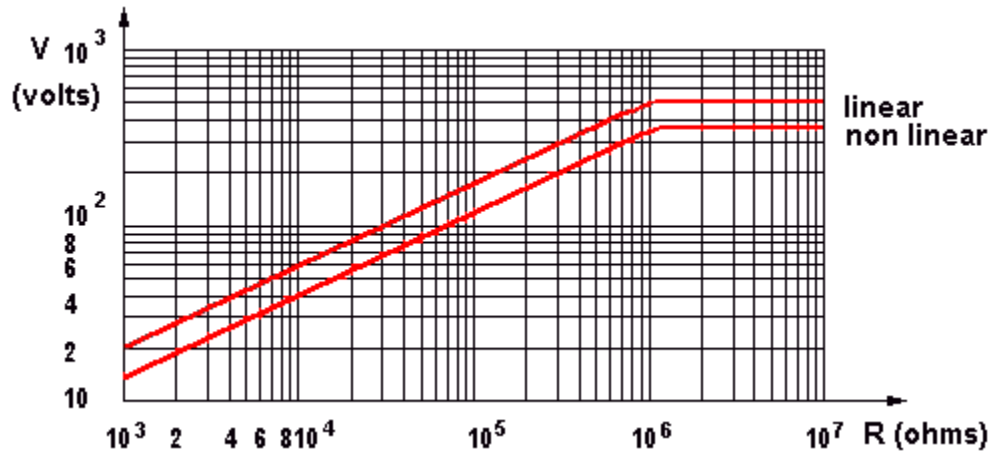

Insulating Voltage: 1000 V AC for 20mm potentiometers

Resistance law A - Linear

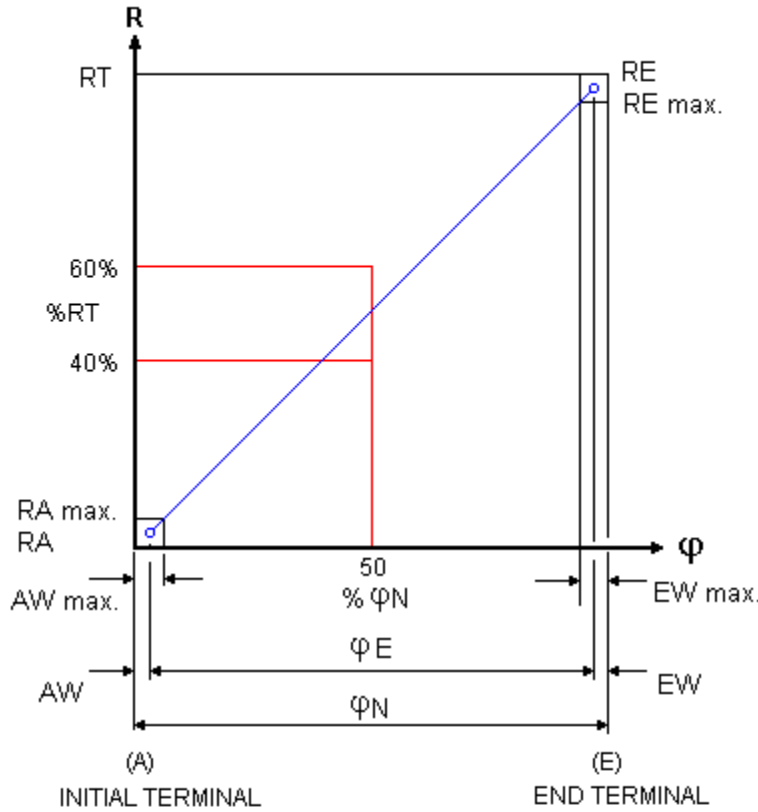

- AW Initial Path AW max. 12% ϕ_N
- EW Final Path EW max. 12% ϕ_N
- Ra Initial Stop Value $\leq 1 \cdot 10^{-3} RN$ (Minimum 2 ohms)
- RA Hop-on Resistance $\leq 1\% RN$
- Re End Stop Value $\leq 1 \cdot 10^{-3} RN$ (Minimum 2 ohms)
- RE Hop-off Resistance $\leq 1\% RN$
- RN Rated Resistance
- RT Effective Resistance
- ϕ Rotation Angle
- ϕE Effective Electrical Angle of Rotation
- ϕN Effective Mechanical Angle of Rotation

Resistance law B – Log (Audio)

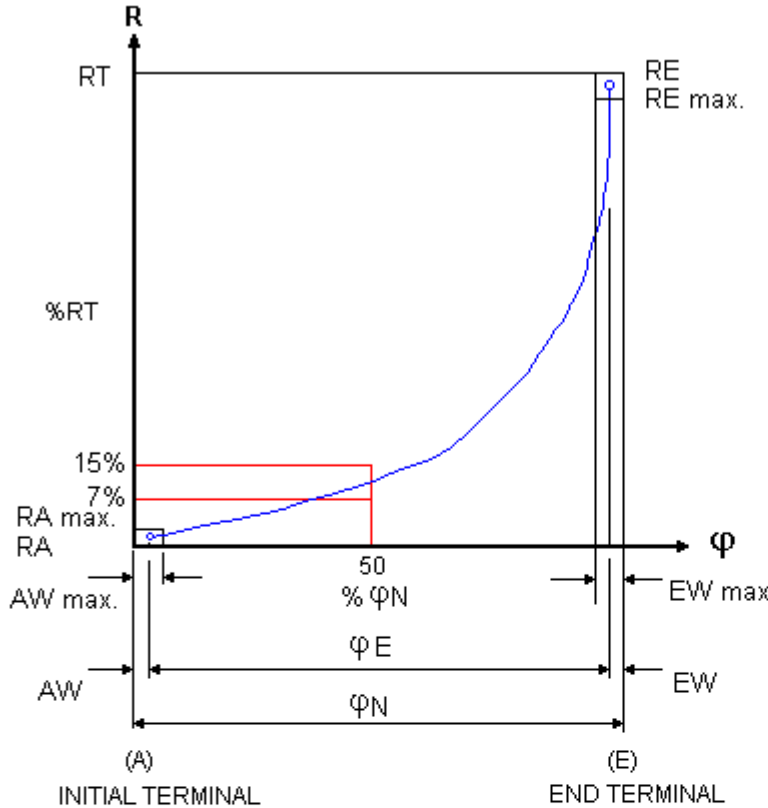

AW	Initial Path	AW max. 10% φN
EW	Final Path	EW max. 10% φN
Ra	Initial Stop Value	RN ≤ 10K ≤ 1.10 ⁻³ RN (Minimum 2 ohms) RN > 10K ≤ 2.10 ⁻⁴ RN (Minimum 10 ohms)
RA	Hop-on Resistance	RN ≤ 10K 5% RN RN > 10K 0.15% RN
Re	End Stop Value	RN ≤ 100K ≤ 2.10 ⁻² RN RN > 100K ≤ 1.10 ⁻² RN
RE	Hop-off Resistance	RN ≤ 10K < 1% RN RN > 10K 0.5% RN
RN	Rated Resistance	
RT	Effective Resistance	
φ	Rotation Angle	
φE	Effective Electrical Angle of Rotation	
φN	Effective Mechanical Angle of Rotation	

Resistance law C – Antilog (Reverse Audio)

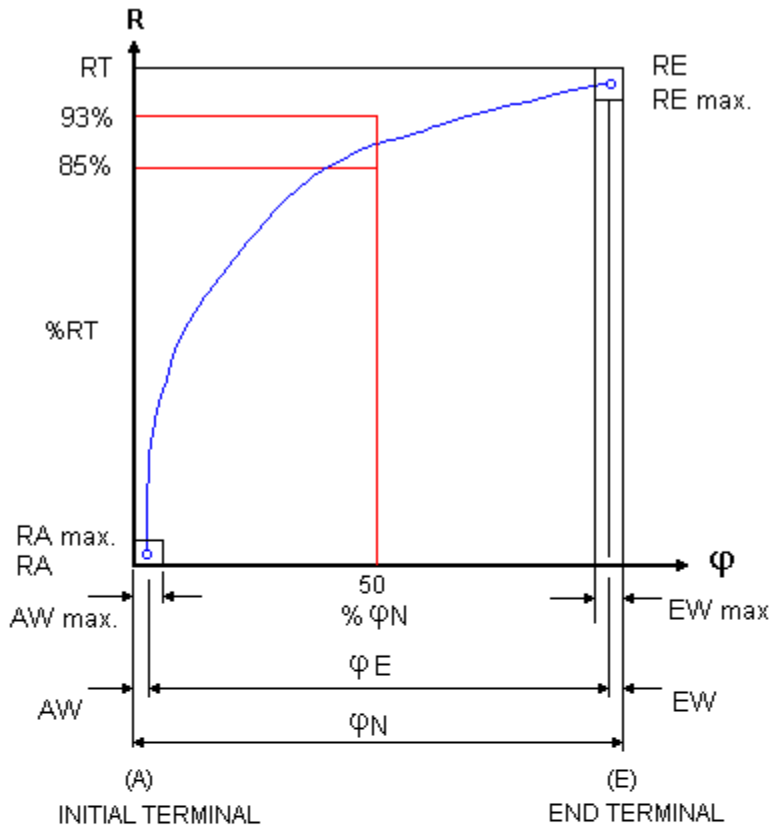

AW	Initial Path	AW max. 10% ϕ_N
EW	Final Path	EW max. 10% ϕ_N
Ra	Initial Stop Value	$R_N \leq 100K \leq 2 \cdot 10^{-2} R_N$ $R_N > 100K \leq 1 \cdot 10^{-2} R_N$
RA	Hop-on Resistance	$R_N \leq 10K < 1\% R_N$ $R_N > 10K 0.5\% R_N$
Re	End Stop Value	$R_N \leq 10K \leq 1 \cdot 10^{-3} R_N$ (Minimum 2 ohms) $R_N > 10K \leq 2 \cdot 10^{-4} R_N$ (Minimum 10 ohms)
RE	Hop-off Resistance	$R_N \leq 10K 5\% R_N$ $R_N > 10K 0.15\% R_N$
RN	Rated Resistance	
RT	Effective Resistance	
ϕ	Rotation Angle	
ϕE	Effective Electrical Angle of Rotation	
ϕN	Effective Mechanical Angle of Rotation	

Linearity

As a basis of assessing Linearity Tolerance the independent method is the most practical, permitting as it does, the reference curve to be aligned as near as possible to the actual output curve. This avoids the use of the theoretical starting and finishing points, it is normal for the customer to realign the achieved curve with series trimmers at each end of the device if required.

Linearity Tolerance is 4% over the Nominal Resistance range of 1K0 to 1M0. The Linearity Tolerance is measured on at least 70% of the effective rotation range.

Note. In the case of Terminal and Zero-based linearity, both present constraints which increase the manufacturing difficulty and in consequence have an adverse effect on the product's price and availability.

Potentiometer linearity

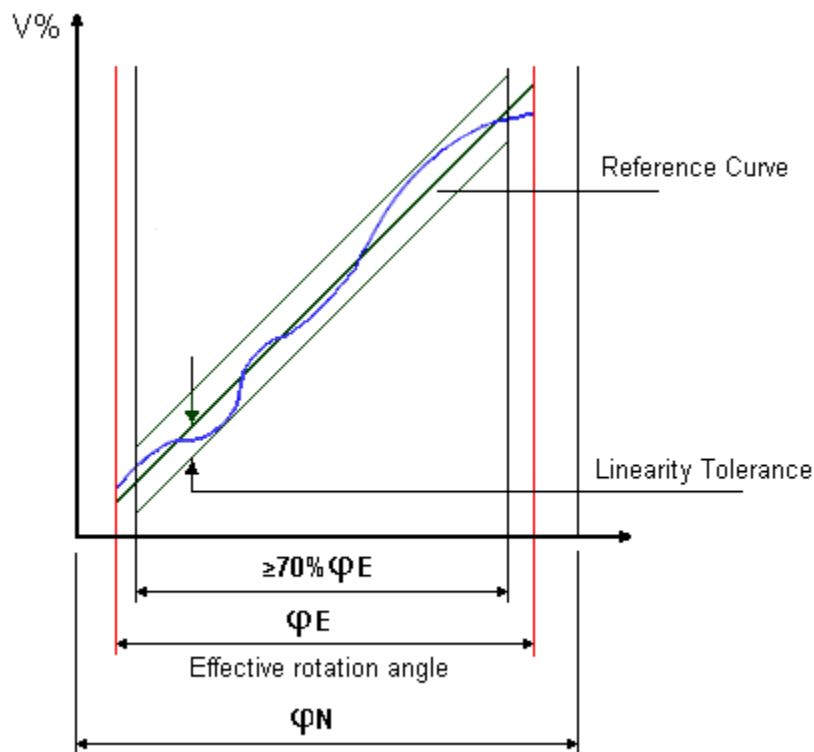

Matching Tolerance (For Tandem Stereo Potentiometers)

Tandem Potentiometers have two identical resistor units with the same variation law. The mismatching of the two resistor units, expressed in dB, is measured by the difference between the attenuations introduced by each resistor unit at various points of travel.

- Law A: 4 dB at Attenuation range 0 - 20 dB
- Law B and C: 3 dB at Attenuation range 0 - 20 dB

Matched Tolerance for Stereo

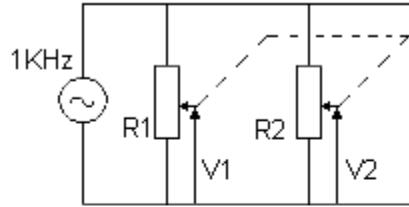

LAW	ATTENUATION RANGE	MATCHING TOLERANCE *
A	0 - 20dB	4dB
B & C	0 - 20dB	3dB

*Matching Tolerance = $20 \text{ Log } \frac{V1}{V2}$

Operating Temperature: -25°C to +70°C

Temperature Derating Curve

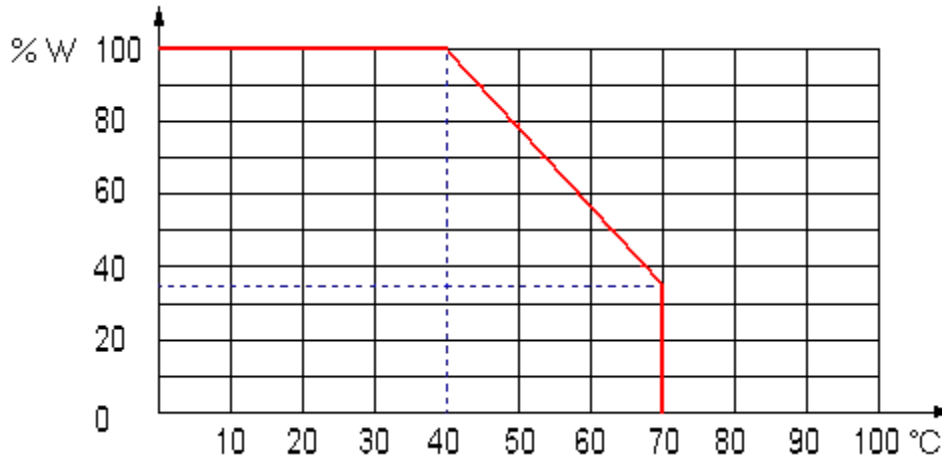

Temperature Coefficient of Resistance: +300 -500 ppm

Components

P20 Bush Housing (Mounting)

The P20 bushes are available in metal or nylon; with three thread options; and with or without a locating feature:

- Diecast Zinc Alloy
 - M10 x0.75mm pitch (Type C)
 - M10 x0.75mm pitch, **with locator** (Type CEBS)
 - 9.52mm x32tpi (Type CBS)
 - 9.52mm x32tpi, **with locator** (Type CBSL)
 - M7 x0.75mm pitch (Type CG)
- Glass Filled Nylon
 - M10 x0.75mm (Type CP)

DIECAST ZINC ALLOY

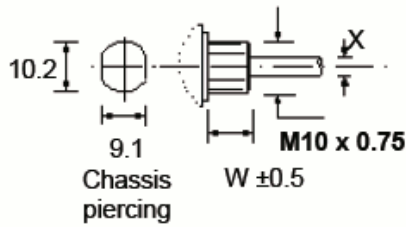

Type C (without locator)	
X (mm)	6
W (mm)	9

DIECAST ZINC ALLOY

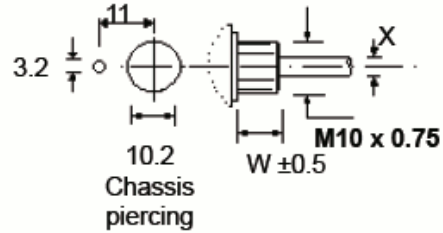

Type CEBS (with locator)	
X (mm)	6
W (mm)	9

DIECAST ZINC ALLOY

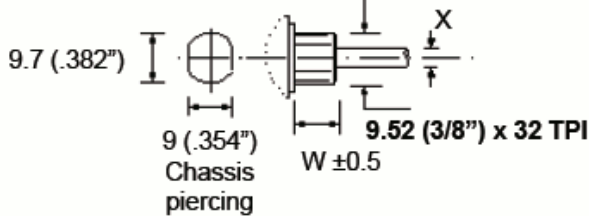

Type CBS (without locator)		
X (mm)	6	6.35
W (mm)	8 or 12	8 or 12

DIECAST ZINC ALLOY

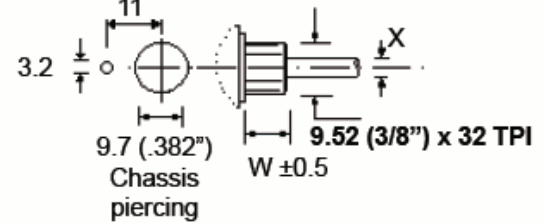

Type CBSL (with locator)		
X (mm)	6.35	6.35
W (mm)	8	12

GLASS FILLED NYLON

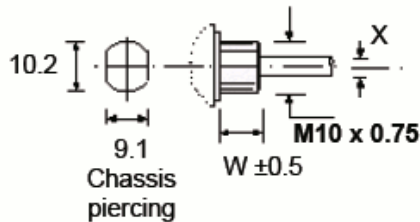

Type CP (GFN)		
X (mm)	6	6.35
W (mm)	7 or 10	7 or 10

DIECAST ZINC ALLOY

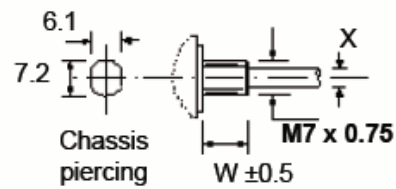

Type CG (without locator)	
X (mm)	4
W (mm)	6

P20 Spindles

The P20 spindles are plastic and fixed i.e. not removable, unless otherwise stated and they are available in three diameters:

- 6.0mm Diameter
 - Cylindrical (Type F1)
 - 4.0 x 12mm Flat (Type F2)
 - 5.0 x 15mm Flat (Type F3)
 - 5.0 x 10mm Flat (Type F4)
 - 4.6mm x 15mm Flat (Type F11)
- 4.0mm Diameter
 - Cylindrical (Type F21)
 - 3.0 x 8.5mm Flat (Type F22)
 - 3.0 x 13.5mm Flat (Type F23)
 - Cylindrical (Type M21 - Metal)
 - 3.0 x 8.5mm Flat (Type M22 - Metal)
 - 3.0 x 13.5mm Flat (Type M23 - Metal)
- 6.35mm Diameter
 - Cylindrical (Type F41)
 - 5.5 x 10mm Flat (Type F42)
 - 5.5 x 15mm Flat (Type F43)
- Splined Spindle - 6.0mm dia. 18 teeth
- Dual Concentric
 - Flatted/Slotted (Type M15 - Metal)
 - Cylindrical (Type M16 - Metal)

6.0mm Diameter Spindles

Note: *Specials to customer's specification up to 65mm.

REMOVABLE SPINDLES, similar in specification to 'fixed' spindles are supplied separate from the potentiometer. These can be indefinitely taken in and out and their holding strength is >1kg.

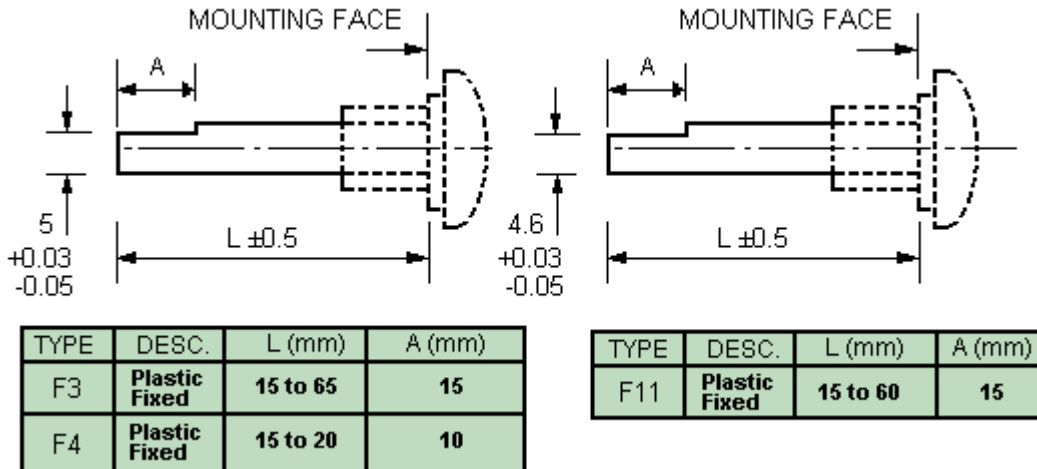
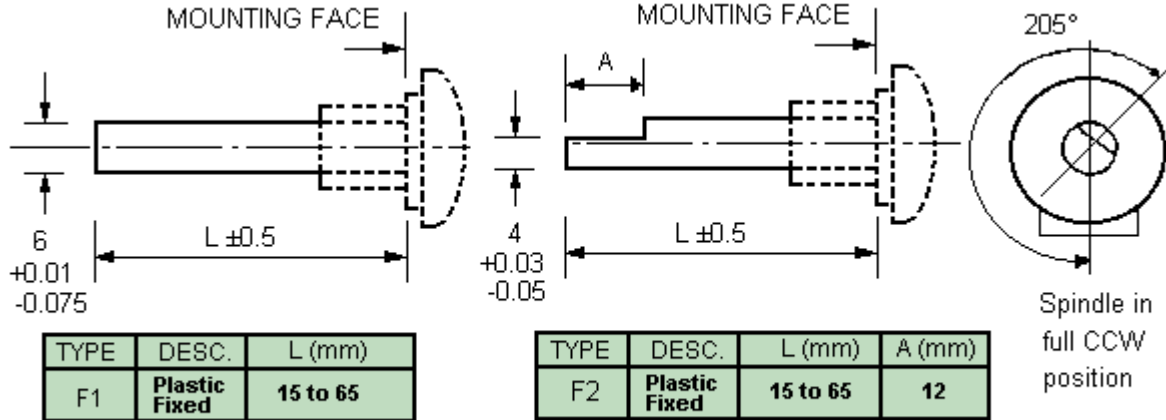

4.0mm Diameter Spindles

Note: The orientation of the flat as illustrated is for plastic spindles only.

For metal spindles, unless specified on the order, the orientation may be different on each potentiometer type.

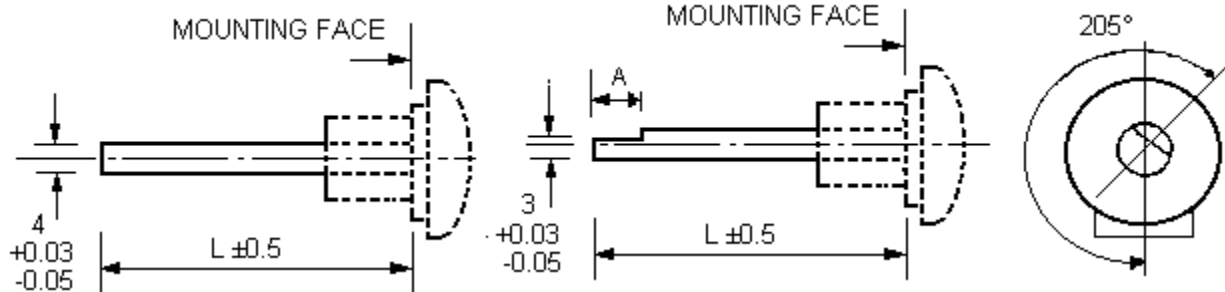

TYPE	DESC.	L (mm)
F21	Plastic Fixed	8 to 65
M21	Metal Fixed	8 to 65

TYPE	DESC.	L (mm)	A (mm)
F22	Plastic Fixed	11 to 60	8.5
M22	Metal Fixed	11 to 60	8.5
F23	Plastic Fixed	16 to 60	13.5
M23	Metal Fixed	16 to 60	13.5

Spindle in full CCW position

6.35mm Diameter Spindles

Note: *Specials to customer's specification up to 65mm.

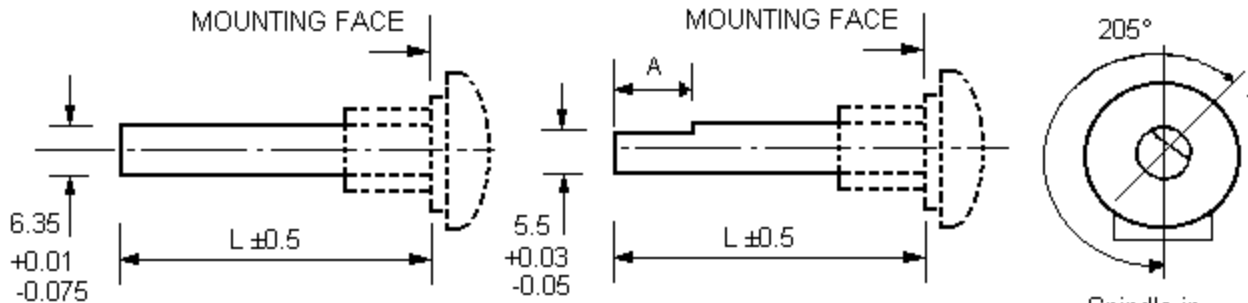

TYPE	DESC.	L (mm)
F41	Plastic Fixed	15 to 65

TYPE	DESC.	L (mm)	A (mm)
F42	Plastic Fixed	15 to 20	10
F43	Plastic Fixed	20 to 60	15

Spindle in full CCW position

Splined Spindle - 6.0mm dia. 18 teeth

A splined form is available on the 6.0mm diameter P20 plastic spindle (F5) or alternatively a 6mm 'Splined Adaptor' (8,7mm long) can be fitted on a 4mm dia. Spindle

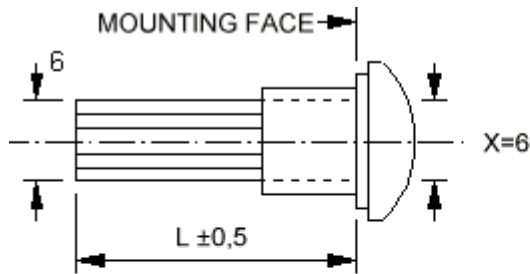

TYPE	DESC.	L (mm)
F5	Plastic Fixed	19

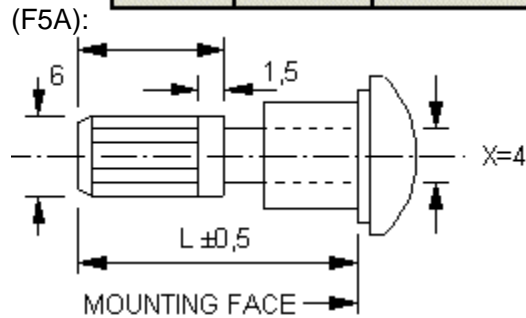
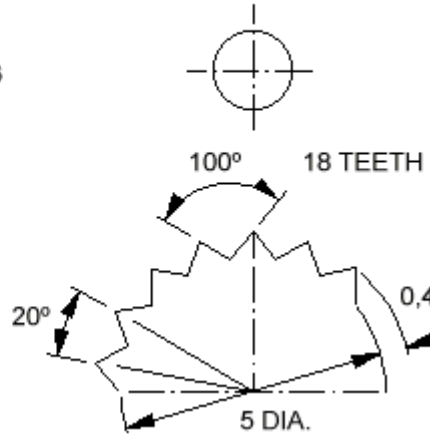

TYPE	DESC.	L (mm)
F5A	Plastic Fixed	16-36

