

AV-04SD



INDIVIDUAL ENTRANCE PANEL



Main features

- Panel type: Individual.
- Camera: 1/4".
- Resolution: 2 Mp.
- Camera angle: 100° (horizontal).
- Output video: HD (1280 × 720), H.264 Main Profile.
- Night backlight: 6 LEDs.
- Light sensitivity: 0,01 LuX.
- Protection class: IP64.
- IK-Code: IK09.
- Working temperature: -40 — +65 °C.
- Power consumption: 6,5 W, in standby — 3,6 W.
- Power supply: PoE, +12 V DC.
- Body: Aluminum.
- Colors: Silver.
- Dimensions: 84 × 170 × 31 mm.
- Installation: Surface mount.

INDIVIDUAL ENTRANCE PANEL

AV-04SD



Full User Manual
wiki.bas-ip.com

Device description

BAS-IP AV-04SD — stylish vandal-proof panel with installation by the wall mount method.

There is also the possibility of individual text or logo appliance on the panel (through in the service center).

Appearance

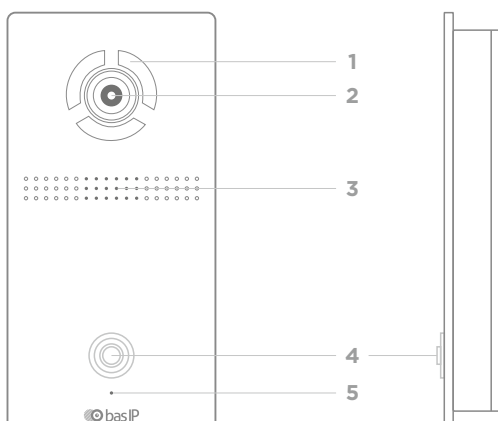

- 1 - Backlight.
- 2 - Camera.
- 3 - Loudspeaker.
- 4 - Mechanical call button.
- 5 - Microphone.

Completeness check of the product

Before installation of the outdoor panel, it is necessary to check that it is complete and all components are available.

Outdoor panel kit includes:

Outdoor panel	1 pc
Surface mounting bracket	1 pc
Manual	1 pc
Set of wires with connectors for connection of power supply, lock, and additional modules	1 pc
Wrench set screws	1 pc

Electrical connection

After verifying the device's completeness, you can switch to the outdoor panel connection.

For connection you will need:

- An Ethernet UTP CAT5 or higher cable connected to a network switch / router.

Cable length recommendations

The maximum length of the UTP CAT5 cable segment should not exceed 100 meters, according to the IEEE 802.3 standard.

- Power supply at +12 V, 2 amps, if there is no PoE.

You can connect any type of electromechanical or electromagnetic lock for which the switched current does not exceed 1 Amp.

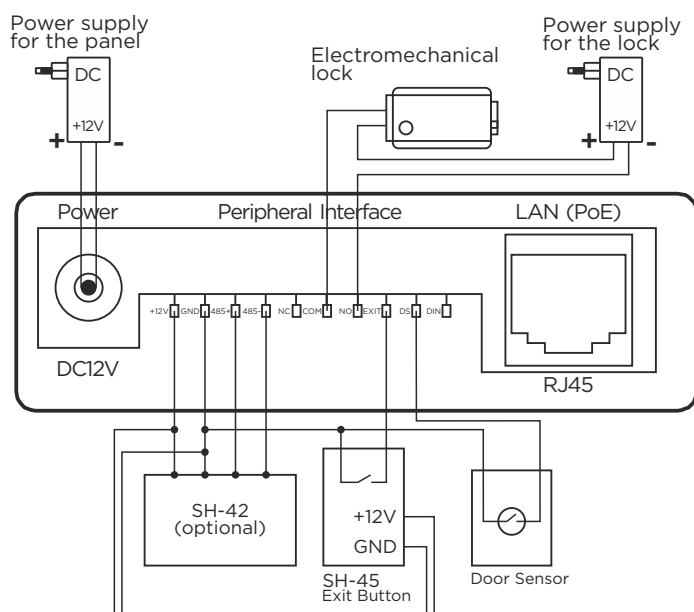

Connection scheme of electromechanical lock using external power supply for panel and the lock.

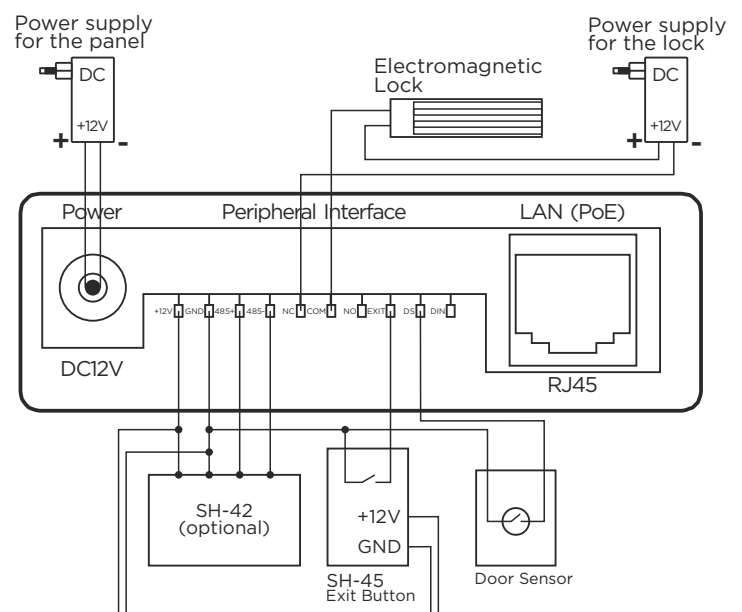

Connection scheme of electromagnetic lock using external power supply for panel and the lock.

Mechanical mounting

Before mounting the door panel, location on the wall with dimensions of 84 × 170 mm must be provided.

It is also necessary to provide supply of a power cable, additional modules and the local network.

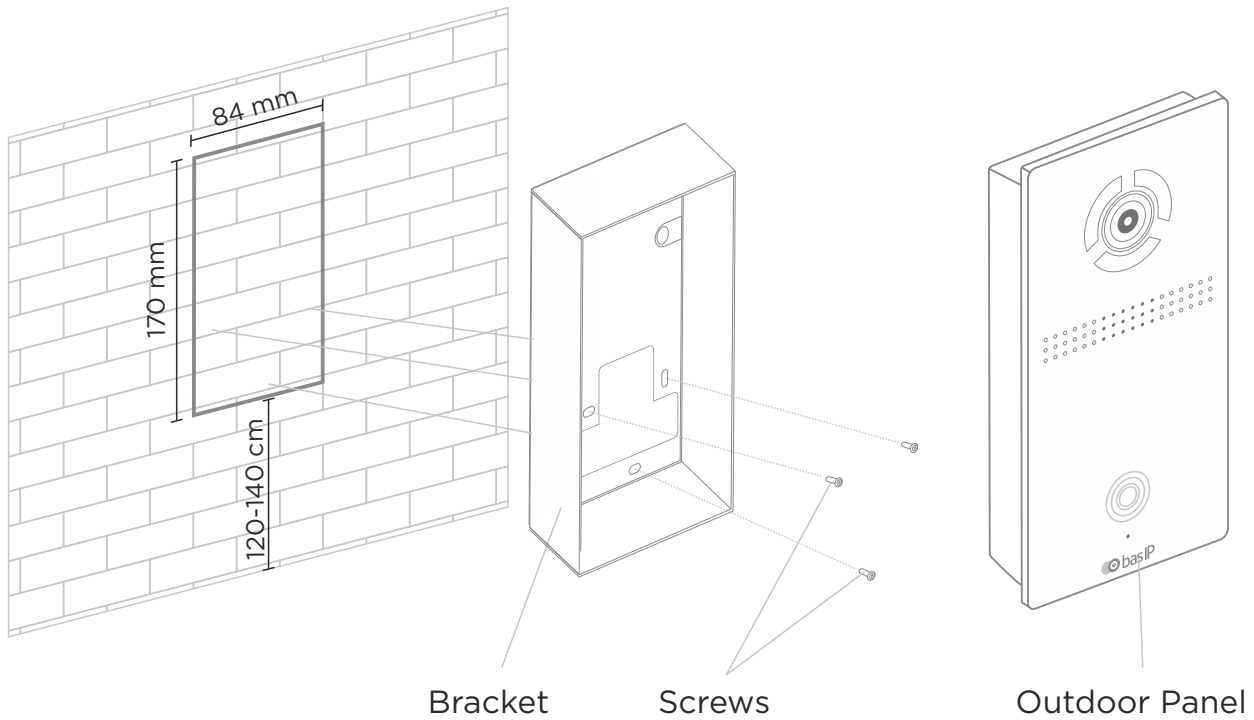

Outdoor Panel

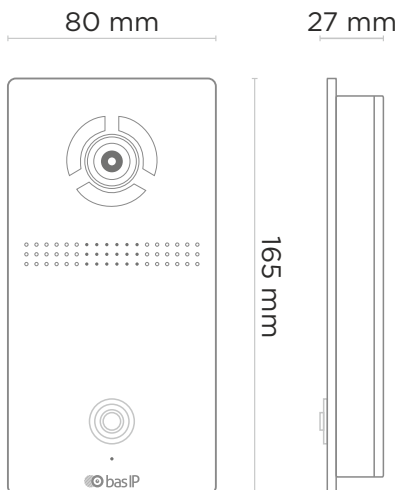

Surface Bracket

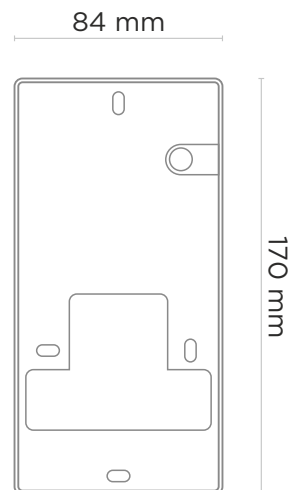

Warranty

The warranty card number _____

Model name _____

Serial number _____

Seller name _____

With following stated terms of warranty is familiar, functional test was performed in my presence:

Customer signature _____

Warranty conditions

The warranty period of the product — 36 (thirty-six) months from the date of sale.

- Transportation of product must be in its original packaging or supplied one by the seller.
- The product is accepted in warranty repair only with a properly filled warranty card and the presence of intact stickers or labels.
- The product is accepted for examination in accordance with the cases provided by law, only in the original packaging, in a full complete set, appearance corresponding to the new equipment and presence of all relevant properly filled documents.
- This warranty is in addition to the constitutional and other consumer rights and in no way restrict them.

Terms of warranty

- The warranty card must indicate the name of the model, serial number, purchase date, name of the seller, seller company stamp and the customer's signature.
- Delivery to the warranty repair is carried out by the buyer himself.
- Warranty repairs carried out only during the warranty period specified in the warranty card.
- The service center is committed to do everything possible to carry out the repair warranty products, up to 24 working days. The period spent on the restoration of product functionality is added to the warranty period.



www.bas-ip.com