

# AYC-Q60

Backlit goPROX & PIN Reader –  
Convertible with Genuine HID  
Technology™



Installation and Programming Manual

GO PROX™  
BY ROSSLARE



**ROSSLARE**  
Secure Access Solutions

## **Copyright © 2022 by Rosslare. All rights reserved.**

This manual and the information contained herein are proprietary to ROSSLARE ENTERPRISES LIMITED and/or its related companies and/or subsidiaries' (hereafter: "ROSSLARE"). Only ROSSLARE and its customers have the right to use the information.

No part of this manual may be re-produced or transmitted in any form or by any means, electronic or mechanical, for any purpose, without the express written permission of ROSSLARE.

ROSSLARE owns patents and patent applications, trademarks, copyrights, or other intellectual property rights covering the subject matter in this manual.

TEXTS, IMAGES, AND ILLUSTRATIONS INCLUDING THEIR ARRANGEMENT IN THIS DOCUMENT ARE SUBJECT TO THE PROTECTION OF COPYRIGHT LAWS AND OTHER LEGAL RIGHTS WORLDWIDE. THEIR USE, REPRODUCTION, AND TRANSMITTAL TO THIRD PARTIES WITHOUT EXPRESS WRITTEN PERMISSION MAY RESULT IN LEGAL PROCEEDINGS.

The furnishing of this manual to any party does not give that party or any third party any license to these patents, trademarks, copyrights or other intellectual property rights, except as expressly provided in any written agreement of ROSSLARE.

ROSSLARE reserves the right to revise and change this document at any time, without being obliged to announce such revisions or changes beforehand or after the fact.

# Table of Contents

<b>1. Introduction.....</b>	<b>9</b>
1.1 Box Content .....	9
1.2 Ancillary Equipment.....	10
<b>2. Installation .....</b>	<b>11</b>
2.1 Mounting.....	11
2.2 Wiring.....	12
2.2.1 Wiring the Unit as a Reader.....	12
2.2.2 Wiring the Unit as a Controller.....	13
<b>3. Reader Operation.....</b>	<b>16</b>
3.1 General.....	16
3.2 Programming as a Reader.....	17
3.2.1 Entering Programming Mode.....	18
3.2.2 Exiting Programming Mode .....	19
3.2.3 Selecting Keypad Transmission Format.....	19
3.2.4 Selecting HID Prox Card Transmission Format .....	25
3.2.5 Selecting Rosslare Proximity Card Transmission Format .....	25
3.2.6 Changing the Programming Code .....	28
3.2.7 Changing the Facility Code.....	28
3.2.8 Setting the Backlight Behavior .....	29
3.2.9 Setting the Credential Format.....	30
3.2.10 Return to Factory Default Settings .....	30
3.2.11 Replacing a Lost Programming Code .....	31
<b>4. Controller Operation.....</b>	<b>32</b>
4.1 Normal, Secure, and Master Users.....	32

## Table of Contents

---

4.2	Modes of Operation.....	33
4.2.1	Normal Mode .....	33
4.2.2	Bypass Mode .....	34
4.2.3	Secure Mode.....	34
4.2.4	Changing the Modes of Operation .....	34
4.3	Auxiliary Input and Output .....	36
4.4	Door Alarms.....	37
4.5	Internal Case and Back Tamper .....	37
4.6	Lockout Feature (Keypad/Card Tamper) .....	37
4.7	REX Function .....	37
4.8	Secured Intelligent Power Supply.....	38
4.9	Programming as a Controller .....	39
4.9.1	Entering Programming Mode.....	40
4.9.2	Exiting Programming Mode .....	40
4.9.3	Changing Lock Strike Code .....	41
4.9.4	Changing Auxiliary Code.....	41
4.9.5	Changing the Programming Code .....	42
4.9.6	Changing the Normal/Secure Code .....	43
4.9.7	Changing the Normal/Bypass Code and Door Chime Settings...43	
4.9.8	Setting Fail Safe/Secure Operation, Tamper Siren and Lock Strike Release Time .....	44
4.9.9	Defining the Auxiliary Input and Output .....	46
4.9.10	Setting the Lockout Feature.....	51
4.9.11	Setting the Backlight Behavior .....	52
4.9.12	Selecting the Credential Format .....	53
4.9.13	Enrolling Primary and Secondary Codes.....	53
4.9.14	Deleting Primary and Secondary Codes .....	57
4.9.15	Relay Codes Assignment.....	59

## Table of Contents

---

4.9.16	PIN Code Length/Factory Default Settings .....	61
4.9.17	Replacing a Lost Programming Code .....	62
4.9.18	Replacing a Lost Normal/Secure Code.....	63
<b>5.</b>	<b>Technical Specifications .....</b>	<b>64</b>
<b>A.</b>	<b>Declaration of Conformity .....</b>	<b>66</b>
<b>B.</b>	<b>Limited Warranty .....</b>	<b>67</b>

## List of Figures

Figure 1: Drilling and Mounting Template.....	11
Figure 2: Controller Application Wiring Diagram.....	14
Figure 3: Controller Wiring – Using the Internal Power .....	15
Figure 4: Controller Wiring – Using the External Power .....	15

## List of Tables

Table 1: Wiring the Reader to the Controller.....	12
Table 2: Wiring the Unit as a Controller.....	13
Table 3: Reader Programming Menu .....	17
Table 4: Controller Programming Menu.....	39
Table 5: Quick Reference Guide for Auxiliary Mode Setting .....	46

# Notice and Disclaimer

This manual's sole purpose is to assist installers and/or users in the safe and efficient installation and usage of the system and/or product, and/or software described herein.

**BEFORE ATTEMPTING TO INSTALL AND/OR USE THE SYSTEM, THE INSTALLER AND THE USER MUST READ THIS MANUAL AND BECOME FAMILIAR WITH ALL SAFETY REQUIREMENTS AND OPERATING PROCEDURES.**

- The system must not be used for purposes other than those for which it was designed.
- The use of the software associated with the system and/or product, if applicable, is subject to the terms of the license provided as part of the purchase documents.
- ROSSLARE exclusive warranty and liability is limited to the warranty and liability statement provided in an appendix at the end of this document.
- This manual describes the maximum configuration of the system with the maximum number of functions, including future options. Therefore, not all functions described in this manual may be available in the specific system and/or product configuration you purchased.
- Incorrect operation or installation, or failure of the user to effectively maintain the system, relieves the manufacturer (and seller) from all or any responsibility for consequent noncompliance, damage, or injury.
- The text, images and graphics contained in the manual are for the purpose of illustration and reference only.
- All data contained herein subject to change without prior notice.
- In no event shall manufacturer be liable for any special, direct, indirect, incidental, consequential, exemplary or punitive damages (including, without limitation, any and all damages from business interruption, loss of profits or revenue, cost of capital or loss of use of any property or capital or injury).
- All wiring diagrams are intended for reference only, the photograph or graphic of the PCB(s) are intended for clearer illustration and understanding of the product and may differ from the actual PCB(s).



# 1. Introduction

The AYC-Q60 is a Rosslare goPROX and PIN reader with Genuine HID Technology™, as well as Rosslare's Convertible technology. The unit automatically determines whether to function as a reader or as a secured standalone controller. If the unit is connected to a standard access control unit, then it functions as a reader. If the unit is connected to a Rosslare secured intelligent power supply, it functions as a 500 user secured standalone controller.

As a reader, the unit can read all HID Prox cards/tags (125 kHz FSK) using Genuine HID Technology and outputs HID Prox card data in Wiegand according to the number of bits of data stored on the card. The unit also reads Rosslare proximity cards (125 kHz) and can output Rosslare proximity card data as Wiegand 26-Bit, Clock & Data, and Wiegand + PIN.

As a controller, the unit accepts up to 500 users, and allows entry via a personal identification number (PIN) and/or by presenting a proximity card. The PIN code length for the controller has several options. The PIN code length can be a set number of 4, 5, or 6 digits or it can be flexible from 4 to 8 digits.

## 1.1 Box Content

Before beginning, verify that all of the following is in the box. If anything is missing, please report the discrepancy to your nearest Rosslare office.

- One AYC-Q60 unit
- Installation kit
- Installation and operating instructions

### 1.2 Ancillary Equipment

The following equipment is required to complete your installation:

- When functioning as a reader:  
Compatible host controller (not supplied) – UL listed access control unit (such as model AC-215U)
- When functioning as a controller:  
A secured intelligent power supply – such as the PC-25T, PS-A25T, PS-C25T, or PS-C25TU secure controllers



Only PS-C25TU can be used for UL-294 compliant installations.

This unit connects to the following:

- Electric lock strike mechanism or a magnetic lock device, which implements fail safe (power to lock) or fail secure (power to open) functions
- Request-to-Exit (REX) button – normally open type. Switch is closed when pressed
- Door monitor switch

Rosslare accessories can be found on [www.rosslaresecurity.com](http://www.rosslaresecurity.com).

# 2. Installation



Installation of an RFID reader adjacent to metallic surfaces might alter the reader's specifications. To diminish this interference, use a plastic spacer when mounting the reader.

## 2.1 Mounting

Before starting, select the location to mount the unit. This location should be at shoulder height.

### ***To mount the unit:***

1. Peel off the back of the self-adhesive installation template and attach the template to the required location.
2. At the bottom of the unit's case, remove the screw.
3. Remove the cover by lifting it up slightly and then pulling it apart. Once you remove the cover, you will see the screw holes for mounting.
4. Depending on the type of installation, gang box or panel mount, drill the respective holes in the rear cover: for gang box mounting, drill two holes marked "A"; for flat panel mount, drill four holes marked "B" (Figure 1).

**Figure 1: Drilling and Mounting Template**

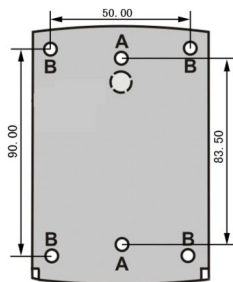

## Installation

---

5. Drill an additional 10-mm ( $7/16$ " ) hole for the cable. When installing the reader on a metallic surface, cover the inside of the hole with a grommet or electrical tape.
6. Insert the unit's cable wire into the cable hole and wire the unit as described in Section 2.2.
7. Screw the back plate into the surface. Ensure the screws are the size specified on the installation template.



The unit can also be mounted using strong epoxy glue. After application, firmly hold the unit in place until the glue dries.

8. Carefully re-attach the front cover of the unit.
9. Secure the front cover by using the supplied security Torx screw. A Torx security screw tool is provided to tighten the security Torx screw.

## 2.2 Wiring

The unit is supplied with a 6-conductor 56-cm (22-in.) pigtail with exposed wires coated with solder.

### 2.2.1 Wiring the Unit as a Reader

If you connect the unit to a standard access control unit, it automatically functions as a reader.

**To connect the unit as a reader (to a controller):**

1. Select the appropriate connections according to Table 1.

**Table 1: Wiring the Reader to the Controller**

Wire Color	Function
Black/Shield	Ground (-)
Red	Vin (+)
Green	Data 0/Data (D0)
White	Data 1/Clock (D1)
Brown	LED control
Purple	Tamper

## Installation

2. Prepare the controller cable by cutting the cable jacket back 3.2 cm (1¼") and strip the wire 1.3 cm (½").
3. Splice the reader's pigtail wires to the corresponding controller wires and cover each joint with insulating tape.
4. If the tamper output is being utilized, connect the purple wire to the correct input on the controller.
5. Trim and cover all conductors that are not used.



Note

- The individual wires extending from the reader are color-coded according to the required Wiegand standard.
- When using a separate power supply for the reader, this supply and the controller's power supply must have a common ground. A linear power supply is recommended.
- Attach the cable shield wire on the reader to an earth ground (best), or to a signal ground connection at the panel or power supply end of the cable. This configuration is best for shielding the reader cable from external interference.

### 2.2.2 Wiring the Unit as a Controller

If you connect the unit to a Rosslare secured power supply, it automatically functions as a controller.

#### ***To connect the unit as a controller:***

1. Select the appropriate connections according to Table 2.

**Table 2: Wiring the Unit as a Controller**

Controller	Wire Color	Function	Note
+	Red	+DC Input	Wired to the PS-x25x
-	Black	Ground	Wired to the PS-x25x
C 1	White	Communication	Wired to the PS-x25x
C 2	Green	Communication	Wired to the PS-x25x
AUX. IN	Brown	Auxiliary Input	Wired to input
N/A	Purple	Not in use	N/A

## Installation



Attach the cable shield wire on the unit to an earth ground (best). You can also attach it to a signal ground connection at the panel or power supply end of the cable. This configuration is best for shielding the controller cable from external interference.

2. Prepare the secured power supply's cable by cutting the cable jacket back 3.2 cm (1¼") and strip the wire 1.3 cm (½").
3. Splice the controller pigtail wires to the corresponding secured power supply's wires and cover each joint with insulating tape.
4. Trim and cover all conductors not used.
5. To connect the unit to the desired power supply option, refer to the relevant wiring diagrams that follow.

Figure 2 shows the wiring for the controller application using a dual relay secured intelligent power supply.

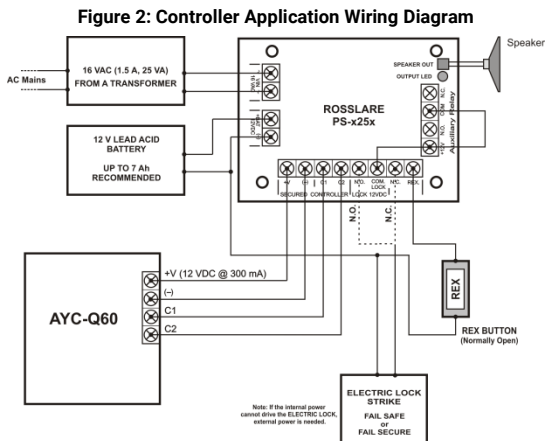

## Installation

Figure 3 shows the auxiliary output connection using the internal power.

**Figure 3: Controller Wiring – Using the Internal Power**

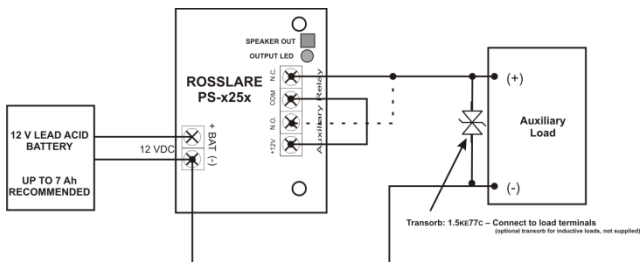
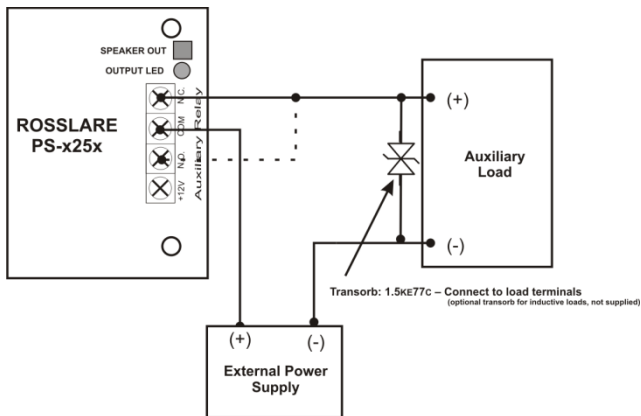

Figure 4 shows the auxiliary output connection using the external power.

**Figure 4: Controller Wiring – Using the External Power**



### 3. Reader Operation

The AYC-Q60 can function both as a reader and as a controller. If the unit is connected to standard access controller, it functions as a reader, indicated by one beep immediately after power-on reset.

#### 3.1 General

The default mode of the reader is Standby mode. In Standby mode, the unit is ready to receive data from a presented proximity card or an entered PIN code.

Programming the reader is done via the unit's keypad driven programming menu system (Section 3.2).

Keypad data can be sent via one of eight keypad transmission formats. For more information, see Section 3.2.3.

HID Prox card data is output in Wiegand according to the number of bits of data stored on the card. See Section 3.2.4 for more information.

Rosslare proximity cards presented to the reader can output card data as Wiegand 26-Bit, Clock & Data, and Wiegand + PIN. See Section 3.2.5 for more information.

When the reader is in Standby mode, the left LED is red and the right LED is off.



When the reader is in Programming mode, the left LED is off and the right LED is green.



When a proximity card is presented or a keypad entry is being transmitted, the left LED flashes green.





## 3.2 Programming as a Reader

Programming is done solely via the unit's keypad driven Programming Menu System. During the manufacturing process, certain codes and settings are pre-programmed. These settings are called the default factory settings.

Table 3 shows the names of all the reader programming menus.

Default factory settings are marked by \*.

**Table 3: Reader Programming Menu**

<b>Menu Description</b>	<b>Default</b>
<b>1 Selecting Keypad Transmission Format</b> Single Key, Wiegand 6-Bit (Rosslare Format) Single Key, Wiegand 6-Bit with Nibble + Parity Bits Single Key, Wiegand 8-Bit, Nibbles Complemented 4 Keys Binary + Facility code, Wiegand 26-Bit 1 to 5 Keys + Facility code, Wiegand 26-Bit 6 Keys Binary-Coded Decimal (BCD) and Parity Bits, Wiegand 26-Bit 1 to 8 Keys BCD, Clock & Data Single key, Wiegand 4-Bit	*
<b>2 Selecting Rosslare Proximity Card Transmission Format</b> Wiegand 26-Bit Clock & Data Wiegand Card + PIN	*
<b>3 Changing the Programming code</b>	<b>1234</b>
<b>4 Changing the Facility code</b>	<b>0</b>
<b>6 Setting the Backlight</b> Always off Always on 10 sec. backlight after key press, otherwise off 10 sec. backlight after key press, otherwise dimmed	*

<b>6</b>	<b>Setting Credential Format</b> Rosslare Proximity HID Prox Rosslare Proximity + HID Prox	*
<b>0</b>	<b>Return to Factory Default Settings</b>	

### 3.2.1 Entering Programming Mode

To reach the Programming Menu System, the unit must first be placed into Programming mode.



Note

- The factory 4-digit Programming code is 1234.
- If a Programming code is not entered within 30 seconds, the unit returns to Standby mode.

#### ***To enter Programming mode:***

1. Press # four times.

The left LED turns off and the right LED turns red.



2. Enter your 4-digit Programming code.

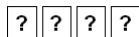

If the Programming code is valid, the right LED turns green.



If the Programming code is invalid, you hear a long beep and the reader returns to Standby mode.

If no key is pressed for 30 seconds while in Programming mode, the unit returns to Standby mode.

### 3.2.2 Exiting Programming Mode

*To exit Programming mode:*

1. Press # to exit Programming mode at any time.
  - You hear a beep.
  - The left LED turns red and the right LED turns off.



This indicates that the unit has returned to Standby mode.

### 3.2.3 Selecting Keypad Transmission Format

There are eight keypad transmission formats.

More information on each of the keypad transmission formats is presented in Section 3.2.3.1.



Only one keypad transmission format can be active at any one time.

*To select the keypad transmission format:*

1. Enter Programming mode.
2. Press **1** to enter Menu 1.



The left LED turns red.



3. Enter one of the following options:
- 1 – Single Key, Wiegand 6-Bit (Rosslare Format) (default)
  - 2 – Single Key, Wiegand 6-Bit with Nibble + Parity Bits
  - 3 – Single Key, Wiegand 8-Bit, Nibbles Complemented
  - 4 – 4 Keys Binary + Facility Code, Wiegand 26-Bit
  - 5 – 1 to 5 Keys + Facility Code, Wiegand 26-Bit
  - 6 – 6 Keys BCD and Parity Bits, Wiegand 26-Bit
  - 8 – 1 to 8 Keys BCD, Clock & Data Single Key
  - 9 – Single Key, Wiegand 4-Bit



When selecting Option 8, the right LED turns orange and an additional input is required to specify the number of keys in the PIN code.

You hear three beeps.

The system returns to Standby mode.



If an incorrect option number is entered, the reader returns to Standby mode and the keypad transmission format remains unchanged.

### 3.2.3.1 Keypad Transmission Formats

#### Option 1: Single Key, Wiegand 6-Bit (Rosslare Format)

Each key press immediately sends 4 bits with 2 parity bits added – even parity for the first 3 bits and odd parity for the last 3 bits.

0 = 1 1010 0 = "A" in Hexadecimal	6 = 1 0110 0
1 = 0 0001 0	7 = 1 0111 1
2 = 0 0010 0	8 = 1 1000 1
3 = 0 0011 1	9 = 1 1001 0
4 = 1 0100 1	* = 1 1011 1 = "B" in Hexadecimal
5 = 1 0101 0	# = 0 1100 1 = "C" in Hexadecimal

#### Option 2: Single Key, Wiegand 6-Bit Nibble and Parities

Each key press immediately sends 4 bits with 2 parity bits added – even parity for the first 3 bits and odd parity for the last 3 bits.

0 = 0 0000 1	6 = 1 0110 0
1 = 0 0001 0	7 = 1 0111 1
2 = 0 0010 0	8 = 1 1000 1
3 = 0 0011 1	9 = 1 1001 0
4 = 1 0100 1	* = 1 1010 0 = "A" in Hexadecimal
5 = 1 0101 0	# = 1 1011 1 = "B" in Hexadecimal

#### Option 3: Single Key, Wiegand 8-Bit Nibbles Complemented

This option inverts the most significant bits in the message leaving the least 4 significant bits as BCD representation of the key. The host system receives an 8-bit message.

0 = 11110000	6 = 10010110
1 = 11100001	7 = 10000111
2 = 11010010	8 = 01111000
3 = 11000011	9 = 01101001
4 = 10110100	* = 01011010 = "A" in Hexadecimal
5 = 10100101	# = 01001011 = "B" in Hexadecimal

#### Option 4: 4 Keys Binary + Facility Code, Wiegand 26-Bit

This option buffers 4 keys and outputs keypad data with a 3-digit Facility code like a standard 26-bit card output.

The Facility code is set in Programming Menu 4 and can be in the range 000 to 255. The factory default setting for the Facility code is 000 (see Section 3.2.7 for more information).

The keypad PIN code is 4 digits in length and can range between 0000 and 9999. On the fourth key press of the 4-digit PIN code, the data is sent across the Wiegand Data lines as binary data in the same format as a 26-bit card.

If \* or # are pressed during PIN code entry, the keypad clears the PIN code entry buffer, generates a beep, and is ready to receive a new 4-digit keypad PIN code.

If the entry of the 4-digit keypad PIN code is disrupted and no number key is pressed within 5 seconds, the keypad clears the PIN code entry buffer, generates a beep, and is ready to receive a new 4-digit keypad PIN code:

(EP) FFFF FFFF AAAA AAAA AAAA AAAA (OP)

Where:

EP = Even parity for first 12 bits

OP = Odd parity for last 12 bits

F = 8-Bit Facility code

A = 16-Bit code generated from keypad

### **Option 5: 1 to 5 Keys + Facility Code, Wiegand 26-Bit**

Option 5 buffers up to 5 keys and outputs keypad data with a Facility code like a 26-bit card output.

The Facility code is set in Programming Menu 4 and can be in the range 000 to 255. The factory default setting for the Facility code is 000 (see Section 3.2.7 for more information). The keypad PIN code can be one to five digits in length and can range between 1 and 65,535. When entering a keypad PIN code that is less than 5 digits in length, # must be pressed to signify the end of PIN code entry. For keypad PIN codes that are 5 digits in length, on the fifth key

press of the 5-digit PIN code, the data is sent across the Wiegand Data lines as binary data in the same format as a 26-bit card.

If \* is pressed during PIN code entry or a PIN code greater than 65,535 is entered, the keypad clears the PIN code entry buffer, generates a beep and is ready to receive a new 5-digit keypad PIN code.

If the entry of the 1- to 5-digit keypad PIN code is disrupted and a number key or # is not pressed within 5 seconds, the keypad clears the PIN code entry buffer, generates a medium length beep, and is ready to receive a new 1- to 5-digit keypad PIN code:

(EP) FFFF FFFF AAAA AAAA AAAA AAAA (OP)

Where:

EP = Even parity for first 12 bits

OP = Odd parity for last 12 bits

F = 8-Bit Facility code

A = 16-Bit code generated from keypad

### **Option 6: 6 Keys BCD and Parity Bits, Wiegand 26-Bit**

This option sends buffer of 6 keys, adds parity, and sends a 26-bit BCD message. Each key is a four bit equivalent of the decimal number.

The keypad PIN code must be 6 key presses in length. On the sixth key press of the 6-digit PIN code, the data is sent across the Wiegand Data lines as a BCD message.

If the entry of the 6-digit keypad PIN code is disrupted and a number key or # is not pressed within 5 seconds, the keypad clears the PIN code entry buffer, generates a medium length beep, and is ready to receive a new 6-digit keypad PIN code:

(EP) AAAA BBBB CCCC DDDD EEEE FFFF (OP)

Where:

EP = Even parity for first 12 bits

OP = Odd parity for last 12 bits

A = The first key entered

D = Fourth key entered

B = Second key entered

E = Fifth key entered

C = Third key entered

F = Sixth key entered

### **Option 8: 1 to 8 Keys BCD, Clock & Data**

Option 8 buffers up to 8 keys and outputs keypad data without a Facility code like standard Clock and Data card output.

The keypad PIN code can be one to eight digits in length. The PIN code length is selected while programming the reader for Option 8. The reader transmits the data when it receives the last key press of the PIN code. The data is sent across the two data output lines as binary data in Clock & Data format.

If \* or # is pressed during PIN code entry, the keypad clears the PIN code entry buffer, generates a beep, and is ready to receive a new keypad PIN code.

If the entry of the keypad PIN code is disrupted and a number key or # is not pressed within 5 seconds, the keypad clears the PIN code entry buffer, generates a medium length beep, and is ready to receive a new keypad PIN code.



### Option 9: Single Key, Wiegand 4-Bit

With this option, each key press immediately sends 4 bits of data, with no parity bits added.

0 = 0000

6 = 0110

1 = 0001

7 = 0111

2 = 0010

8 = 1000

3 = 0011

9 = 1001

4 = 0100

\*= 1010 = "A" in Hexadecimal

5 = 0101

#=1011 = "B" in Hexadecimal

### 3.2.4 Selecting HID Prox Card Transmission Format

The AYC-Q60 can read **all** HID Prox cards/tags (125 kHz) using Genuine HID Technology and outputs HID Prox card data in Wiegand format according to the number of bits of data stored on the card.

### 3.2.5 Selecting Rosslare Proximity Card Transmission Format

The AYC-Q60 can read Rosslare proximity cards (125 kHz) and can output Rosslare proximity card data as Wiegand 26-Bit, Clock & Data, and Wiegand + PIN.

More information on each of the Rosslare proximity card transmission formats is presented in Section 3.2.5.1.

**To select the Rosslare proximity card transmission format:**

1. Enter Programming mode.
2. Press **2** to enter Menu 2.

The left LED turns red.

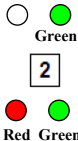

3. Enter one of the following options:

- 1 – Wiegand 26-Bit
- 2 – Clock & Data
- 3 – Wiegand Card + PIN

You hear three beeps.

The system returns to Standby mode.



If an incorrect option is entered, the reader returns to Standby mode and the keypad transmission format remains unchanged.

### **3.2.5.1 Rosslare Proximity Card Transmission Formats**

#### **Option 1: Wiegand 26-Bit**

In this mode, 3 LSB bytes from the card serial number (UID) are transmitted in Wiegand 26-Bit format. Two parity bits are added. An even parity bit is sent first, followed by three bytes of card data, and by an odd parity bit.

(EP) AAAA AAAA AAAA AAAA AAAA AAAA (OP)

Where: EP = Even parity for first 12 bits

OP = Odd parity for last 12 bits

A = 3 bytes code generated from card data

#### **Option 2: Clock and Data**

In this mode, up to 6 bytes of the card serial number are transmitted in Clock & Data format.

### Option 3: Wiegand Card + PIN

This unique mode is intended to let host controllers get card and keypad data simultaneously. This option overrides the selected keypad transmission format and sends the keypad data as described below.

After a card is presented to the unit, the program LED starts to flash in green and indicates that the unit is waiting for the PIN code. If the entry of 1- to 5-digit keypad PIN code is disturbed and a number key or # is not pressed within 5 seconds, the keypad clears the card buffer and the PIN code entry buffer, generates a medium length beep, and is ready to receive a new card.

The keypad PIN code can be one to five digits in length in the range of 0 to 99,999. When entering a keypad PIN code, # must be pressed to signify the end of the PIN entry. When pressing #, the data is sent by the Wiegand data lines. If \* is pressed, the keypad clears the card buffer and the PIN code entry buffer, generates a medium length beep, and is ready to receive a new card.

The AYC-Q60 output card data is in Wiegand 26-Bit with the following keypad data in Wiegand 26-Bit format.

Card Data: (EP) AAAA AAAA AAAA BBBB BBBB BBBB (OP)

Where:

EP = Even parity for first 12 A bits

OP = Odd parity for last B 12 bits

PIN Data: (EP) 0000 AAAA BBBB CCCC DDDD EEEE (OP)

Where:

A = The first key entered

D = Fourth key entered

B = Second key entered

E = Fifth key entered

C = Third key entered

EP = Even parity for first 12 bits

OP = Odd parity for last 12 bits

## Reader Operation

If the PIN code is less than 5 digits, all the most significant nibbles are filled with 0.

Example: (EP) 0000 0000 0000 0000 AAAA BBBB (OP)

Where:

A = The first key entered

B = Second key entered

EP = Even parity for first 12 bits

OP = Odd parity for last 12 bits

### 3.2.6 Changing the Programming Code



- The Programming code cannot be erased; the code 0000 is invalid and does not erase the Programming code.
- The factory default 4-digit Programming code is 1234.

#### *To change the Programming code:*

1. Enter Programming mode.



Green

2. Press **3** to enter Menu 3.



The left LED turns red.



Red Green

3. Enter the new 4-digit code you wish to set as the Programming code.

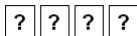

You hear three beeps.



Red

The system returns to Standby mode.

### 3.2.7 Changing the Facility Code



- The Facility code can be in the range of 000 to 255.
- The default Facility code is 0.

#### *To change the Facility code:*

1. Enter Programming mode.



Green

2. Press **4** to enter Menu 4.



The left LED turns red.



3. Enter the new 3-digit code you wish to set as the Facility code.

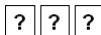

You hear three beeps.

The system returns to Standby mode.



### 3.2.8 Setting the Backlight Behavior

*To set the backlight behavior:*

1. Enter Programming mode.
2. Press **6** to enter Menu 6.



The left LED turns red.



3. Enter one of the following codes:

- **10** – Always off
- **11** – Always on
- **12** – Backlight is off, activates for 10 seconds when a key is pressed (left LED also goes on), after which it dims until off (left LED also goes off)
- **13** – Backlight is dimmed, activates for 10 seconds when a key is pressed (left LED also goes on), after which it returns to a dimmed level

You hear three beeps.

The system returns to Standby mode.



### 3.2.9 Setting the Credential Format

*To set the credential format:*

1. Enter Programming mode.
2. Press **6** to enter Menu 6.

The left LED turns red.

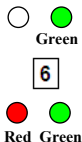

3. Enter one of the following codes:
  - **61** for Rosslare Proximity
  - **62** for HID Prox
  - **63** for Rosslare Proximity and HID Prox (default)

You hear three beeps.

The system returns to Standby mode.



### 3.2.10 Return to Factory Default Settings



You must be very careful before using this command! This erases the entire memory and returns all codes to their factory default setting.

*To return to factory default settings:*

1. Enter Programming mode.
2. Press **0** to enter Menu 0.

Both LEDs flash red.
3. Enter your 4-digit Programming code.

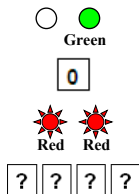

If the Programming code is valid, all memory is erased. You hear three beeps and the reader returns to Standby mode.

If the Programming code is invalid, you hear a long beep and the reader returns to Standby mode without erasing the memory of the reader

### **3.2.11 Replacing a Lost Programming Code**

In the event that the Programming code is forgotten, the unit can be reprogrammed in the field.

#### ***To replace a lost Programming code:***

1. Remove power from the reader.
2. Activate the tamper by removing the reader from the wall or removing the reader's case.
3. Apply power to the reader.
4. You now have 10 seconds to enter Programming mode using the factory default Programming code 1234.

# 4. Controller Operation

The AYC-Q60 can function both as a reader and as a controller. If the unit is connected to a Rosslare secured intelligent power supply, it functions as a controller indicated by two beeps immediately after power-on reset.

The Lock Strike Output and REX input are not located on the unit, eliminating the possibility of unauthorized entry to the restricted area.

## 4.1 Normal, Secure, and Master Users

The unit accepts up to 500 users and provides entry via the use of PIN codes and/or proximity cards. Each user is provided with two code memory slots: Memory Slot 1 (Primary code) and Memory Slot 2 (Secondary code).

The PIN code length has several options. The PIN code length can be a set number of 4, 5 or 6 digits or it can be a 4–8 digits option. When choosing the 4–8 digit option, please note that you should either enter zeros before the code, or press # at the end (for example if your code is 12345, enter either **00012345** or **12345#**).



Entering a code refers to either PIN or card depending on the model you have.

The way in which the two memory slots are programmed determines a user's access level and also determines the way in which the unit grants access in its three modes of operation. There are three user levels:

- Normal

A Normal user only has a Primary code and is only granted access when the unit is in Normal or Bypass mode.



- Secure

A Secure user must have a Primary and Secondary code programmed; the two codes cannot be the same. The Secure User can gain access when the unit is in any of its three modes of operation. In Normal mode, the Secure user must use the Primary code to gain entry. In Secure mode, the Secure user must present both the Primary and Secondary codes to gain entry.

- Master

A Master user must have both Primary and Secondary codes programmed with the same code. The Master user can gain access during any mode of operation by presenting the PIN code and/or proximity card one time to the controller. (The Master user is convenient but is less secure than a Secure user.)

## 4.2 Modes of Operation

There are three modes of operation:

### 4.2.1 Normal Mode

The left LED is green.



Normal mode is the default mode. In Normal mode, the door is locked until a Primary code is presented to the controller. Special codes such as Lock Strike code and Auxiliary code are active in Normal mode. (See Sections 4.9.3 and 4.9.4 for more information.)

### 4.2.2 Bypass Mode

The left LED is orange.



In Bypass mode, access to the premises is dependent on whether the controller's Lock Strike Relay is programmed for Fail Safe Operation or Fail Secure Operation. When the Lock Strike is programmed for Fail Secure Operation, the door is locked until \* is pressed. When the Lock Strike is programmed for Fail Safe Operation, the door is constantly unlocked.

### 4.2.3 Secure Mode

The left LED is red.



Only Secure and Master users can access the premises in Secured mode.

A Secure user must enter the Primary and Secondary codes to gain entry. After entering the Primary code, the right LED flashes green for 10 seconds, during which the Secondary code must be entered. A Master user only needs to present the code once to gain entry.

## 4.2.4 Changing the Modes of Operation

### 4.2.4.1 Changing from Normal Mode to Secure Mode

The default factory setting for the Normal/Secure code is 3838.

### ***To change from Normal to Secure mode:***

1. Enter the Normal/Secure code.

The left LED flashes red.

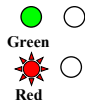

2. Press # to confirm the mode change.

The left LED stops flashing.



### **4.2.4.2 Changing from Secure Mode to Normal Mode**

The default factory setting for the Normal/Secure code is 3838.

### ***To change from Secure to Normal mode:***

1. Enter the Normal/Secure code.

The left LED flashes green.



2. Press # to confirm the mode change.

The left LED stops flashing.



### **4.2.4.3 Changing from Normal Mode to Bypass Mode**

See Section 4.9.7 to create/modify the Normal/Bypass code.

### ***To change from Normal to Bypass mode:***

1. Enter the 4-digit Normal/Bypass code.

The left LED flashes orange.



2. Press # to confirm the mode change.

The left LED stops flashing.



### **4.2.4.4 Changing from Bypass Mode to Normal Mode**

See Section 4.9.7 to create/modify the Normal/Bypass code.

### ***To change from Bypass to Normal mode:***

1. Enter the 4-digit Normal/Bypass code.

The left LED flashes green.



2. Press # to confirm the mode change.

The left LED stops flashing.



## **4.3 Auxiliary Input and Output**

For optimum usability in different applications, the controller's auxiliary input and output can be configured in 10 different modes of operation (see Section 4.9.9).

### **4.4 Door Alarms**

Door alarms can be generated by connecting the Auxiliary Input to a Door Position Switch. Either Door-Forced or Door-Ajar conditions are supported, as well as a configurable delay timer for each alarm type. Only one door-alarm is enabled at any one time. Door alarms may activate auxiliary output and siren depending on the auxiliary settings.

### **4.5 Internal Case and Back Tamper**

If the unit is forcibly opened or it is removed from the wall, a tamper event is triggered. A tamper output opens sending a signal to the connected alarm system (purple wire); the event closes when the tamper is closed (case is re-closed or re-attached to the wall).

The tamper event can also activate the auxiliary output if the controller is in Auxiliary Mode 3 (see Table 5).

### **4.6 Lockout Feature (Keypad/Card Tamper)**

If the controller is presented with wrong codes (PIN or card) consecutively several times, the unit goes into Lockout mode.

When a lockout occurs, the controller's reader and keypad are deactivated so no codes can be entered until the set lockout period expires.

During Lockout mode, the left LED is Off, the right LED flashes red, and the controller beeps every two seconds.

### **4.7 REX Function**

The REX button is connected to a Rosslare secured intelligent power supply. The REX button must be located inside the premises to be secured and is used to open the door without the use of a PIN code. It is usually located in a convenient location, such as inside the door or at a receptionist's desk. The function of the REX button depends on whether the Lock Strike Relay is programmed for Fail

Safe Operation or Fail Secure Operation.

- Fail Secure Operation  
From the moment the REX button is pressed, the door is unlocked until the Lock Strike Release Time passes. After this time, the door is locked even if the REX button is not released.
- Fail Safe Operation  
From the moment the REX button is pressed, the door is unlocked until the REX button is released, plus the Lock Strike Release Time. In this case, the Lock Strike Relay only begins its count down once the REX button is released.

### 4.8 Secured Intelligent Power Supply

Rosslare's secured intelligent power supplies are designed for use with Rosslare's secured standalone access control units, including the AYC-Q60. The AYC-Q60 unit is designed to operate indoors and is installed within the secured premises. The unit must be used with one of Rosslare's secured intelligent power supplies, which provides Lock Strike output and REX input. The AYC-Q60 and the power supply communicate through a proprietary Rosslare protocol, which provides a secure link between them. This in turn activates the door lock.

Each power supply unit contains a speaker connection for all sounder abilities.

For more information, see the *PS-x25x Installation Manual*.

## 4.9 Programming as a Controller

Programming is performed solely via the unit's keypad driven Programming Menu System. To reach the Programming Menu System, the unit must first be placed into Programming mode. See Section 4.9.1 for more information.

During the manufacturing process, certain codes and settings are pre-programmed. These settings are called the default factory settings.

Table 4 shows the names of all the controller programming menus. It also shows of all the default factory codes and settings.

**Table 4: Controller Programming Menu**

Menu No.	Menu Description	Default			
		4 digits	5 digits	6 digits	4-8 digits
1	Changing Lock Strike Code	2580	25802	258025	25802580
2	Changing Auxiliary Code	0852	08520	085208	08520852
3	Changing Program Code	1234	12341	123412	12341234
4	Changing Normal/Secure Code	3838	38383	383838	38383838
5	Changing Normal/Bypass Code	N/A			
6	Changing Door Release Time	0004			
	Defining auxiliary inputs/outputs	2004			
	Set Lockout	4000			
	Backlight Behavior	5100			
	Credential Format	6300			
7	Enrolling PIN Code	N/A			
8	Deleting PIN Code	N/A			
9	Code Assignment with Strike/Auxiliary	N/A			
0	Return to Factory Defaults/Change PIN Code Length	N/A			

You will find instructions for each of the above menu items in the following subsections.

### 4.9.1 Entering Programming Mode



Note

- The unit must be in Normal mode to enter Programming mode.
- The factory 4-digit Programming code is 1234.
- If a Programming code is not entered within five seconds, the unit returns to Normal mode.

#### **To enter Programming mode:**

1. Press # twice.

The left LED turns off and the right LED turns red.



2. Enter your 4-digit Programming code.

The right LED turns green.

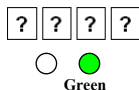

### 4.9.2 Exiting Programming Mode

#### **To exit Programming mode:**

1. Press # twice to exit Programming mode at any time.

You hear 3 beeps.

The left LED turns green and the right LED turns off.



Wrong entries reset the controller back to Normal mode.

While in Programming mode, if no key is pressed for one minute, the unit returns to Normal mode.



### 4.9.3 Changing Lock Strike Code

The Lock Strike code is mainly used as a method to quickly test the Lock Strike Relay during installation.

When the first user is added to the controller, the default Lock Strike code is automatically deleted. Once the code is programmed again, it is not deleted with the entry of additional user codes.



- Lock Strike code does not work in the Secure mode.
- Wrong entries return the controller to Normal mode.
- Code 0000 erases the Lock Strike code.
- The factory default 4-digit Lock Strike code is 2580.

#### *To change the Lock Strike code:*

1. Enter Programming mode.
2. Press **1** to enter Menu 1.

The left LED turns red.

3. Enter the new code you wish to set as the Lock Strike code.

You hear three beeps.

The system returns to Normal mode.

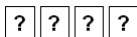

### 4.9.4 Changing Auxiliary Code

The Auxiliary code is mainly used as a method to quickly test the Auxiliary Relay during installation.



- Auxiliary code does not work in the Secure mode.
- Wrong entries return the controller to Normal mode.
- Code 0000 erases the Auxiliary code.
- The factory default 4-digit Auxiliary code is 0852.

### To change the Auxiliary code:

1. Enter Programming mode.

2. Press **2** to enter Menu 2.

The left LED turns orange.

3. Enter the new Auxiliary code.

You hear three beeps.

The system returns to Normal mode.

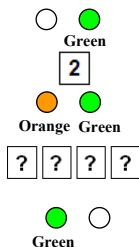

## 4.9.5 Changing the Programming Code



Note

- The Programming code cannot be erased; the code 0000 is invalid and does not erase the Programming code.
- The factory default 4-digit Programming code is 1234.

### To change the Programming code:

1. Enter Programming mode.

2. Press **3** to enter Menu 3.

The left LED turns green.

3. Enter the new 4-digit Programming code.

You hear three beeps.

The system returns to Normal mode.

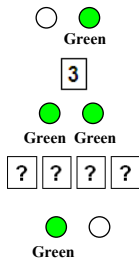

### 4.9.6 Changing the Normal/Secure Code



- Code 0000 erases the Normal/Secure code.
- This code is disabled if the Auxiliary Input is set to toggle between Normal and Secure access modes.
- The default Normal/Secure code is 3838.

#### **To change the Normal/Secure code:**

1. Enter Programming mode.



2. Press **4** to enter Menu 4.



The left LED flashes red.



3. Enter the new Normal/Secure code.

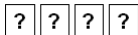

You hear three beeps.



The system returns to Normal mode.

Green

### 4.9.7 Changing the Normal/Bypass Code and Door Chime Settings

#### **To change the Normal/Bypass code and door chime settings:**

1. Enter Programming mode.



2. Press **5** to enter Menu 5.



The left LED flashes orange.



3. There are four different ways to program the Normal/Bypass code and door chime:

Disable both Bypass code and the door chime. Enter the code **0000**.

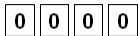

Disable Bypass code and enable the door chime. Enter the code **0001**.

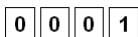

Enable Bypass code and disable the door chime. Enter any code ending with 0.

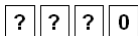

Enable Bypass code and enable the door chime. Enter a code not ending with 0.

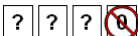

You hear three beeps.



The system returns to Normal mode.

Green

### 4.9.8 Setting Fail Safe/Secure Operation, Tamper Siren and Lock Strike Release Time



The default value is 0004, which corresponds to Fail Secure operation, no siren, and 4-seconds Lock Strike release time.

#### To set the Fail Safe/Secure Operation, Tamper Siren and Lock Strike Release Time:

1. Enter Programming mode.



2. Press **6** to enter Menu 6.



The left LED flashes green.

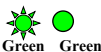

3. Construct a code using the following instructions:

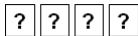

- First digit

For Fail Secure Operation, the first digit should be **0**.

For Fail Safe Operation the first digit should be **1**.

- Second digit

Siren Time in minutes (1–9, 0 – disabled)

- Third and fourth digits

Enter the number of seconds (from 1 to 99) that you want the Lock Strike to be released.

## Controller Operation

---

For example, **0312** means a Fail Secure Operation consisting of a 3-minute siren and a 12-second Lock Strike release time.

You hear three beeps.

The system returns to Normal mode.



### 4.9.9 Defining the Auxiliary Input and Output

The default auxiliary setting is 2004.

**To define the auxiliary input and output:**

1. Enter Programming mode.



2. Press **6** to enter Menu 6.



The left LED flashes green.



3. Construct a code using the following instructions:

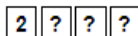

- Second digit (Auxiliary Mode)

In addition to the Lock Strike Relay and Lock Strike REX, the unit features an Auxiliary Input. The Auxiliary mode defines the function of the Auxiliary Input.

- Third and fourth digits (Auxiliary Setting)

Each of the Auxiliary modes has a 2-digit setting that affects how the Auxiliary mode functions (Table 5).

You hear three beeps.



The system returns to Normal mode.

Green

**Table 5: Quick Reference Guide for Auxiliary Mode Setting**

Auxiliary Mode	Auxiliary Input Function	Auxiliary Output Activated by	Auxiliary Relay	Auxiliary Settings (in seconds)
0	AUX REX	Valid code or AUX REX	N.O.	01 to 99 Aux. relay release time 00 Aux. relay toggle
1	Normal/Secure switch	Valid code	N.O.	01 to 99 Aux. relay release time 00 Aux. relay toggle

## Controller Operation

<b>Auxiliary Mode</b>	<b>Auxiliary Input Function</b>	<b>Auxiliary Output Activated by</b>	<b>Auxiliary Relay</b>	<b>Auxiliary Settings (in seconds)</b>
2	Normal/Secure switch	Star button (*)	N.O.	01 to 99 Aux. relay release time 00 Aux. relay toggle
3	Normal/Secure switch	Tamper event	N.C.	01 to 99 Aux. relay release time 00 Aux. relay tamper activated
4	Normal/Secure switch	Direct shunt	N.O.	01 to 99 Shunt time
5	Door Monitor	Shunt	N.C.	01 to 99 Maximum shunt time
6	Door Monitor	Forced door	N.C.	01 to 99 Forced delay
7	Door Monitor	Door ajar	N.C.	01 to 99 Ajar delay
8	LED control – Green	Valid code	N.O.	01 to 99 Aux. relay release time 00 Aux. relay toggle
9	LED control – Red	Valid code	N.O.	01 to 99 Aux. relay release time 00 Aux. relay toggle

The following subsections describe each Auxiliary mode.

### **4.9.9.1 Auxiliary Mode 0**

**Auxiliary input function:** Activates the auxiliary output

**Auxiliary output activated by:** Valid user code, Auxiliary code, Auxiliary input

For example, in Auxiliary Mode 0, the controller can function as a two-door controller. The auxiliary relay is to be attached to the lock on the second door. The auxiliary setting defines the door open time for the second door. The auxiliary input is to be attached to the

REX pushbutton for the second door. The Door Monitor input feature for the second door is not enabled when using this mode.

### **4.9.9.2 Auxiliary Mode 1**

**Auxiliary input function:** Toggles Normal/Secure modes

**Auxiliary output activated by:** Valid user code, Auxiliary code

For example, in Auxiliary Mode 1, the controller can function as a two-door controller. The auxiliary relay is to be attached to the lock on the second door. REX feature for the second door is not enabled when using this mode.

The auxiliary setting defines the door open time for the second door. The auxiliary input can switch the mode of operation of the controller between Normal and Secure mode. By connecting a switch timer or alarm system output to the auxiliary input, the controller can be automatically switched from Normal mode (during office hours) to Secure mode (after office hours).

### **4.9.9.3 Auxiliary Mode 2**

**Auxiliary input function:** Toggles normal/secure modes

**Auxiliary output activated by:** Asterisk Button (\*)

For example, in Auxiliary Mode 2, the auxiliary relay can function as a general purpose time switch that can be activated when the asterisk button (\*) is depressed. The auxiliary setting establishes for how long the auxiliary relay is to be activated. The auxiliary input can switch the mode of operation of the controller between Normal and Secure modes. By connecting a switch timer or alarm system output to the auxiliary input, the controller can be automatically switched from Normal mode (during office hours) to Secure mode (after office hours).

### **4.9.9.4 Auxiliary Mode 3**

**Auxiliary input function:** Toggles Normal/Secure modes

**Auxiliary output activated by:** Alarms

For example, in Auxiliary Mode 3, the auxiliary output is activated if the controller is tampered; that is, if the case is forcibly opened or



removed from the wall. The auxiliary input can switch the mode of operation of the controller between Normal and Secure modes. By connecting a switch timer or alarm system output to the auxiliary input, the controller can be automatically switched from Normal mode (during office hours) to Secure mode (after office hours).

### **4.9.9.5 Auxiliary Mode 4**

**Auxiliary input function:** Toggles Normal/Secure modes

**Auxiliary output activated by:** Direct shunt (explanation below)

For example, in Auxiliary Mode 4, the controller is capable of bypassing an alarm zone by shunting an alarm system's door sensor. The auxiliary output is to be wired in parallel to the door sensor output. When in use, the auxiliary output is normally open and the door sensor functions normally. When a valid code is entered, the auxiliary relay shunts the door sensor for the duration of the shunt time, as defined by the auxiliary setting. If the door is left open longer than the shunt time, an alarm is triggered.

### **4.9.9.6 Auxiliary Mode 5**

**Auxiliary input function:** Door Monitor

**Auxiliary output activated by:** Shunt (explanation below)

For example, in Auxiliary Mode 5, the controller is capable of shunting an alarm system. In this mode, the auxiliary input is to be wired to the magnetic contact switch on the door. The auxiliary relay is wired to the alarm system. Without a valid code entered, the auxiliary relay matches the condition of the magnetic contact switch; if the door opens, the auxiliary relay opens; if the door closes, the auxiliary relay closes. When a valid code is entered, a countdown for maximum shunt time, as defined by the auxiliary setting, begins; if the door is not closed before the maximum shunt time, the alarm is triggered.

### **4.9.9.7 Auxiliary Mode 6**

**Auxiliary input function:** Door Monitor

**Auxiliary output activated by:** Forced entry

For example, in Auxiliary Mode 6, the controller can trigger the auxiliary relay if the door has been forced. If the siren settings are enabled, the siren is activated.

In this mode, the auxiliary input functions as a door monitor switch and is wired to the magnetic contact switch on the door. The auxiliary relay is to be wired to the alarm system. If the door is forced open, the controller waits for the period of the forced door delay time to elapse and then it activates the auxiliary relay. The auxiliary setting sets the forced door delay period.

### **4.9.9.8 Auxiliary Mode 7**

**Auxiliary input function:** Door Monitor

**Auxiliary output activated by:** Door Ajar (door held open)

For example, in Auxiliary Mode 7, the controller can trigger the auxiliary relay, if it detects that the door has been held open (ajar) too long. In this mode, the auxiliary input functions as a door monitor switch and is wired to the magnetic contact switch on the door. The auxiliary relay is to be wired to the alarm system. If the door is opened, the controller waits for the Door Ajar Delay time to elapse and if the door does not close prior to the end of this period, the controller activates the auxiliary relay. The auxiliary setting defines the door-ajar time.

### **4.9.9.9 Auxiliary Mode 8**



This mode controls the door indicator (right LED).

The right LED is not lit when:

- A valid code is entered
- While in Secure mode when waiting for Secondary code.

**Auxiliary input function:** Green LED control

**Auxiliary output activated by:** Valid user code, Auxiliary code

For example, in Auxiliary Mode 8, the controller can function as a 2-door controller and also provide LED indicator functionality control. The auxiliary relay is connected to the lock on the second door. The auxiliary setting defines the Door Open time for the

second door. The auxiliary input is used to control the door indicator (right LED). If the auxiliary input is open, the right LED flashes green; if the auxiliary input is closed, the right LED flashes red.

### 4.9.9.10 Auxiliary Mode 9



Note

This mode controls the door indicator (right LED).

The right LED is not lit when:

- A valid code is entered
- While in Secure mode when waiting for Secondary code.

**Auxiliary input function:** Red LED control

**Auxiliary output activated by:** Valid user code, Auxiliary code

For example, in Auxiliary Mode 9, the controller can function as a 2-door controller and also provide LED indicator functionality control. The auxiliary relay is connected to the lock on the second door. The auxiliary setting defines the Door Open time for the second door. The auxiliary input is used to control the door indicator (right LED). If the auxiliary input is open, the right LED flashes red; if the auxiliary input is closed the right LED flashes green.

### 4.9.10 Setting the Lockout Feature

If the controller is presented with wrong codes (PIN or card) consecutively several times, the unit goes into Lockout mode.

When a lockout occurs, the controller keypad and reader are locked so no codes can be entered until the set lockout period expires. During Lockout, the left LED is Off, the right LED flashes red, and the controller beeps every two seconds. The default setting for the Lockout Feature is 4000 (Lockout Disabled).



Using the lockout feature is highly recommended, especially when using a short PIN code length (4 or 5 digits).

### To set the lockout feature:

1. Enter Programming mode.



2. Press **6** to enter Menu 6.



The left LED flashes green.

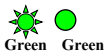

3. Construct a code using the following instructions:

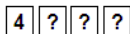

- Second digit

Set the number of wrong code attempts, which causes a Lockout between 0 and 9 attempts.

- Third and fourth digits

Sets the Duration of the lockout, between 00 and 99; the value is multiplied by ten, resulting in 0 to 990 seconds.

### 4.9.11 Setting the Backlight Behavior

The controller allows you to define the way the unit's backlight works.

#### To set the backlight behavior:

1. Enter Programming mode.



2. Press **6** to enter Menu 6.



The left LED flashes green.

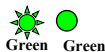

- Enter one of the following codes:
  - 5000** – Backlight off
  - 5100** – Backlight on (default)
  - 5200** – Backlight is off, activates for 10 seconds when a key is pressed, after which it dims until off
  - 5300** – Backlight is dimmed, activates for 10 seconds when a key is pressed, after which it returns to a dimmed level

### 4.9.12 Selecting the Credential Format

*To select the credential format:*

- Enter Programming mode.
- Press **6** to enter Menu 6.



The left LED flashes green.

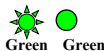

- Enter one of the following codes:
  - 6100** – Rosslare Proximity
  - 6200** – HID Prox
  - 6300** – Rosslare Proximity + HID Prox (default)

### 4.9.13 Enrolling Primary and Secondary Codes

#### 4.9.13.1 Primary Codes

- Primary codes can only be enrolled to an empty user slot, meaning a slot where there is no existing Primary code.
- Primary codes must be unique, meaning one user's Primary code may not be the same as other user's Primary code.
- Primary codes cannot be the same as any system codes, such as the Normal/Secure code or Lock Strike code.
- Users who hold a Primary code can gain entry only during Normal mode.

### 4.9.13.2 Secondary Codes

- Secondary codes can only be enrolled to user slot that already has a Primary code enrolled but no Secondary code.
- Secondary codes do not have to be unique, meaning multiple users can all hold the same Secondary code.
- Secondary codes cannot be the same as any system codes, such as the Normal/Secure code or Lock Strike codes.
- Users who hold Secondary codes can gain entry in any mode of operation.

### 4.9.13.3 Enrolling Methods

There are two methods to enroll Primary and Secondary codes:

- Standard Method

The Standard Method is mainly used when the user slot number for the user you wish to program is known. You can program both Primary and Secondary codes using the Standard Method (see Section 4.9.13.4).

- Code Search Method

The Code Search Method is mainly used when enrolling a user's Secondary code and the User Slot code is unknown.

The Code Search method only works if a user's Primary code is already enrolled but the Secondary code is not (see Section 4.9.13.5).

### 4.9.13.4 Enrolling Primary and Secondary Codes using the Standard Method

*To enroll Primary and Secondary codes using the Standard method:*

1. Enter Programming mode.
2. Press **7** to enter Menu 7.

The right LED turns orange.

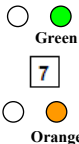

3. Enter the 3-digit user slot number between 001 and 500 for the slot to which you wish to enroll a Primary or Secondary code.



For example, User Slot 003 represents User #3.

If the selected slot has no Primary code, the left LED flashes green, indicating that the controller is ready to accept a Primary code.

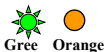

If the selected slot already has a Primary code but no Secondary code, the left LED flashes red, indicating that the controller is ready to accept a Secondary code.



If the selected slot already has a Primary and Secondary code, you hear a long beep and the controller returns to Normal mode.



4. Perform one of the following:

- Enter the PIN code that you want to assign as the Primary or Secondary code for this slot number.
- Present your user card that you want to assign as the Primary or Secondary code for this slot number.

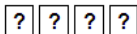

If the PIN or user card presented is valid, the left LED stops flashing and the controller is ready for you to enter the next 3-digit slot number (refer to Step 3) for the slot to which you want to assign a code.

5. Do one of the following:

- Press # to move to the next available user slot number.
- Enter another 3-digit user slot number.
- If you do not wish to continue enrolling codes, press # twice and the controller returns to Normal mode.

### **4.9.13.5 Enrolling Secondary Codes using the Code Search Method**

The Code Search feature enables you to quickly enroll a Secondary code to a user who already has a Primary code.

***To enroll secondary codes using the Code Search method:***

1. Enter Programming mode.



2. Press **7** to enter Menu 7.



The right LED turns orange.



3. Enter **000** as the 3-digit user slot number.

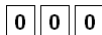

The right LED flashes orange.



4. Perform one of the following:

- Enter the PIN code belonging to the user for whom you wish to add a Secondary code.
- Present the user card belonging to the user for whom you wish to add a Secondary code.

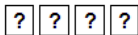

The left LED flashes red.



If the Primary code entered is not valid, you hear a long beep and the unit continues to wait for a valid Primary code.



5. Perform one of the following:

- Enter the PIN code to be used as the Secondary code.

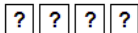

- Present the user card to be used as the Secondary code.

If the Secondary code is valid, the controller beeps three times and returns to Normal mode.

If the Secondary code is invalid, the controller sounds a long beep, and the unit continues to wait for a valid Secondary code to be entered.

### 4.9.14 Deleting Primary and Secondary Codes

There are two methods to delete Primary and Secondary codes: the Standard Method and the Code Search Method.

When deleting a user slot, both the Primary code and the Secondary code are erased.



Note

It is recommended that a record be kept of added and deleted users so that it is easier to keep track of which user slots are empty and which user slots are not.

#### 4.9.14.1 Deleting Primary and Secondary Codes using the Standard Method

**To delete the Primary and Secondary codes using the Standard Method:**

- Enter Programming mode.
- Press **8** to enter Menu 8.



The left LED turns red and the right LED turns orange.



- Enter the 3-digit User Slot code you wish to delete.



The left LED flashes red indicating the controller is waiting for the Programming code to confirm the deletion.



If the user slot is empty, you hear a long beep and the unit returns to Normal mode.

4. Enter your 4-digit Programming code to confirm the deletion.

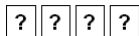

If the Programming code is valid, three beeps are heard and the controller returns to Normal mode.

If the Programming code is invalid, a long beep is heard and the controller returns to Normal mode.

### **4.9.14.2 Deleting Primary and Secondary Codes using the Code Search Method**

***To delete the Primary and Secondary codes using the Code Search Method:***

1. Enter Programming mode.



2. Press **8** to enter Menu 8.



The left LED turns red and the right LED turns orange.



3. Enter **000** as the 3-digit user slot number.

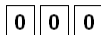

The right LED flashes orange.



4. Perform one of the following:

- Enter the PIN code of the Primary code belonging to the user you want to delete.

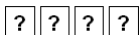

- Present the user card of the Primary code belonging to the user you want to delete.

The left LED flashes red.



- Enter your 4-digit Programming code to confirm the deletion.

If the Programming code is valid, you hear three beeps and the unit returns to Normal mode.

If the Programming code is invalid, you hear a long beep and the unit returns to Normal mode.

### 4.9.15 Relay Codes Assignment

When a Primary code is enrolled for any user, the user is authorized to activate the Lock Strike relay. However, different user codes may be set to operate the auxiliary relay instead or operate both the Lock strike and auxiliary relay. Assigning such codes is possible for any valid user code entered in the controller. There are two methods to assign relay codes to users: a standard method and a search method.

#### 4.9.15.1 Relay Code Assignment using the Standard Method

*To assign relay code using the Standard method:*

- Enter Programming mode.



- Press **9** to enter Menu 9.



The left LED turns green and the right LED turns orange.



- Enter the 3-digit user slot for code assignment.



The left LED flashes green.



- Enter the assignment digit for the current user slot:

- 1 activates the Lock Strike relay only default
- 2 activates the Auxiliary relay only
- 3 activates the Lock Strike and Auxiliary relays

If the assignment code is valid, the left LED stops flashing.

The controller is now waiting for another slot number.

- Do one of the following:

- Press # to move to the next available user slot number.
- Enter another 3-digit user slot number.

If you do not wish to continue enrolling codes, press # twice and the controller returns to Normal mode.

### 4.9.15.2 Relay Code Assignment using the Search Method

*To assign relay code using the Search method:*

- Enter Programming mode.



- Press 9 to enter Menu 9.



The left LED turns green and the right LED turns orange.



- Enter 000 for user slot access.

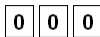

The right LED flashes orange.



- Do one of the following:

- Enter the PIN code of the Primary code belonging to the user you want to delete.
- Present the user card of the Primary code belonging to the user you want to delete.

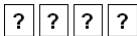

The left LED flashes green.



5. Enter the assignment digit for the current user slot:

- **1** activates the Lock Strike relay only default
- **2** activates the Auxiliary relay only
- **3** activates the Lock Strike and Auxiliary relays

If the assignment digit is valid, three beeps are heard and the controller returns to Normal mode.

If the assignment digit is invalid, a long beep sounds and the controller waits for another assignment digit to be entered.

### 4.9.16 PIN Code Length/Factory Default Settings



Warning

You must be very careful before using this command! Changing the PIN code length also erases the entire memory contents, including all user and special codes, and returns all codes to their factory default settings.

**To change the PIN code length:**

1. Enter Programming mode.



2. Select the desired PIN code length as follows:

- **00** – Returns to factory defaults and sets a 4-digit code
- **05** – Returns to factory defaults and sets a 5-digit code
- **06** – Returns to factory defaults and sets a 6-digit code
- **08** – Returns to factory defaults and sets a 4–8 digit code



Note

When choosing the 4–8 option, please note that you should either enter zeros before the code, or press # at the end (for example if your code is 12345, enter either **00012345** or **12345#**).

Both LEDs flash red.



3. Enter your 4-digit Programming code.

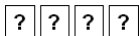

If the Programming code is valid, all memory is erased. You hear three beeps and the controller returns to Normal mode.

If the Programming code is invalid, you hear a long beep and the controller returns to Normal mode without erasing the memory contents.

### 4.9.17 Replacing a Lost Programming Code



The unit must be in Normal mode; otherwise, this does not work. Make sure that the left LED is green before proceeding.

#### ***To replace a lost Programming code:***

1. Remove power from the power supply unit.
2. Press the REX button on the power supply unit.
3. Apply power to the unit with REX button pressed.
4. Release the REX button.
5. You now have 15 seconds to program a new Programming code into the access control unit using the default code based on the PIN code length you chose (see Table 4) before the controller reverts to the existing code.

### 4.9.18 Replacing a Lost Normal/Secure Code



The unit must be in Secure mode; otherwise, this does not work. Make sure that the left LED is red before proceeding.

#### ***To replace a lost Normal/Secure code:***

1. Remove power from the power supply unit.
2. Press the REX button on the power supply unit.
3. Apply power to the unit with the REX button pressed.
4. Release the REX button.
5. You now have 15 seconds to program a new Normal/Secure code into the access control unit using the default code based on the PIN code length you chose (see Table 4) before the controller reverts to the existing code.

## 5. Technical Specifications

<b>Electrical Characteristics</b>	
<b>Power Supply Type</b>	Linear (recommended)
<b>Operating Voltage Range</b>	5–16 VDC (when used as a controller, provided by the secured intelligent power supply)
<b>Input Current Standby (12 VDC)</b>	90 mA
<b>Input Current Max (12 VDC)</b>	135 mA
<b>LED Control Input</b>	Dry contact N.O.
<b>Tamper Output</b>	Open collector, active low, 32 mA max sink current
<b>Cable Distance to Host Controller</b>	Up to 150 m (500 ft) using an 18-AWG cable
<b>Max. Proximity Card Read Range*</b>	45 mm (1.8 in.)
<b>Proximity Card Modulation</b>	Rosslare proximity/HID Prox at 125 kHz
<b>Proximity Card Compatibility</b>	Rosslare proximity/HID Prox cards
<b>Card Transmit Format (Reader)</b>	Rosslare proximity cards: Wiegand 26-bit, or Clock & Data HID cards: According to card type
<b>Keypad Transmit Format (Reader)</b>	Programmable PIN code formats
<b>LED Indicators</b>	Two tri-colored LEDs
<b>Communication</b>	Data1/C1, Data0/C2—open collector, 5 V termination
<b>Line Security</b>	Level I
<b>Standby Power</b>	Level I
<b>Endurance</b>	Level IV
<b>Destructive Attack</b>	Level I

\* Measured using a Rosslare proximity card or equivalent. Range also depends on electrical environment and proximity to metal.



## Technical Specifications

---

---

### Environmental Characteristics

<b>Operating Temp. Range</b>	-22°F to 150°F (-30°C to 65°C)
<b>Operating Humidity Range</b>	0 to 95% (non-condensing)
<b>Outdoor Usage</b>	Weather-resistant, meets IP-65, epoxy potted, suitable for indoor and outdoor use

---

### Physical Characteristics

<b>Size (Height x Width x Depth)</b>	120 x 76 x 21 mm (4.7 x 3.0 x 0.8 in.)
<b>Weight</b>	480 g (16.9 oz)

---

### A. Declaration of Conformity

This device complies with Part 15 of the FCC Rules. Operation is subject to the following two conditions:

- This device may not cause harmful interference.
- This device must accept any interference received, including interference that may cause undesired operation.

Changes or modifications not expressly approved by the party responsible for compliance could void the user's authority to operate the equipment.

This equipment has been tested and found to comply with the limits for a Class B digital device, pursuant to part 15 of the FCC Rules. These limits are designed to provide reasonable protection against harmful interference in a residential installation.

This equipment generates, uses, and can radiate radio frequency energy and, if not installed and used in accordance with the instructions, may cause harmful interference to radio communications. However, there is no guarantee that interference will not occur in a particular installation. If this equipment does cause harmful interference to radio or television reception, which can be determined by turning the equipment off and on, the user is encouraged to try to correct the interference by one or more of the following measures:

- Reorient or relocate the receiving antenna.
- Increase the separation between the equipment and receiver.
- Connect the equipment into an outlet on a circuit different from that to which the receiver is connected.
- Consult the dealer or an experienced radio/TV technician for help.

### **B. Limited Warranty**

The full ROSSLARE Limited Warranty Statement is available in the Quick Links section on the ROSSLARE website at [www.rosslaresecurity.com](http://www.rosslaresecurity.com).

Rosslare considers any use of this product as agreement to the Warranty Terms even if you do not review them.



**AYC-Q60**

## **Asia Pacific, Middle East, Africa**

Rosslare Enterprises Ltd.  
Kowloon Bay, Hong Kong  
Tel: +852 2795-5630  
Fax: +852 2795-1508  
support.apac@rosslaresecurity.com

## **United States and Canada**

Rosslare Security Products, Inc.  
Southlake, TX, USA  
Toll Free: +1-866-632-1101  
Local: +1-817-305-0006  
Fax: +1-817-305-0069  
support.na@rosslaresecurity.com

## **Europe**

Rosslare Israel Ltd.  
22 Ha'Melacha St., P.O.B. 11407  
Rosh HaAyin, Israel  
Tel: +972 3 938-6838  
Fax: +972 3 938-6830  
support.eu@rosslaresecurity.com

## **Latin America**

Rosslare Latin America  
Buenos Aires, Argentina  
support.la@rosslaresecurity.com

## **China**

Rosslare Electronics (Shenzhen) Ltd.  
Shenzhen, China  
Tel: +86 755 8610 6842  
Fax: +86 755 8610 6101  
support.cn@rosslaresecurity.com

## **India**

Rosslare Electronics India Pvt Ltd.  
Tel/Fax: +91 20 40147830  
Mobile: +91 9975768824  
sales.in@rosslaresecurity.com

**ROSSLARE**  
SECURITY PRODUCTS



• EN ISO 14883

