

503060 EZ-Power Wireless Remote Control

INSTRUCTIONS INSTALLATION & OPERATION

These instructions are meant as a guide only. They do not bind Draper, Inc. in any way and do not imply any responsibility of Draper, Inc. for improper installation or faulty workmanship at the job site.

PARTS LIST:

QTY	Part#	Description
1	C156.123	Wireless Receiver / Operator w/C010.337 Mounting Plate
1	C079.079	Plug- Twist Lock - NEMA L-14-20P
1	C201.007	Receptacle - Twist Lock - NEMA L14-20
1	C095.121	4" Cover x 1/2" Deep w/1.618" Hole
2	C020.485	1/2"-13 x 1 1/4" Hex Bolt
2	C018.088	1/2"-13 Flange Lock Nut

** Also required - No. 503061 99-Station Handheld Transmitter, purchased separately.



1. Locate and identify all parts using the hardware list and the drawings. "As built" drawings and hardware list are packed in hardware carton. Do not discard with packing material.
2. DO NOT touch any motorized equipment while it is in motion.
3. Operates on 110-120V, 60 Hz current (unless noted otherwise).
4. Key switch or controls to be in full view of equipment, and in full view of both sides of curtain, during operation.
5. Wiring diagram can be found inside winch limit cover panels.

Please Note: Custom products/ installations may not be reflected by this document. Call Draper, Inc. if you have questions about your installation.

Overview

The No. 503060 EZ-Power Wireless Remote Control operator is a radio frequency (RF) controlled motor operator designed for use with Draper Backstop Winches, Divider Curtains and Electric Height Adjusters. The receiver is factory installed in an enclosure with a 60" long cord with a twist-lock grounded plug attached. Enclosure also includes four-prong, twist-lock female receptacle as well as an external terminal block for connection of an optional low voltage key switch. It is not necessary to make any electrical connections inside the enclosure.

Please Note: Electrician should install Draper supplied twist lock receptacle and cover within 3' of location of winch or motor as shown on the project submittals.

Mounting Instructions

1. If using with Draper Backstop Winch, Divider Curtain or Electric Height Adjuster: Connect the C079.079 male twist lock plug to the whip that is attached to the device. The cord should be connected with the green wire hooked to terminal G, white wire connected to terminal W, red wire connected to terminal X and the black wire connected to terminal Y (see wiring diagram on page 2).
2. Attach 503060 Wireless Remote Control Operator to backstop or divider winch or to clamp on mast pipe for an electric height adjuster using hardware supplied in a location that allows the operator to be plugged into the receptacle installed by the electrician (see below illustrations).
3. Insert winch cord plug into female receptacle that is mounted in the 503060 Wireless Remote Control Operator.
4. Insert cord on 503060 Wireless Remote Operator into receptacle installed by electrician.
5. As necessary, program frequency of receiver by following the instructions on page 2.

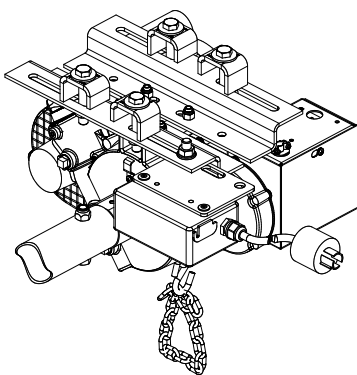

503060 with Motorized Divider Winch

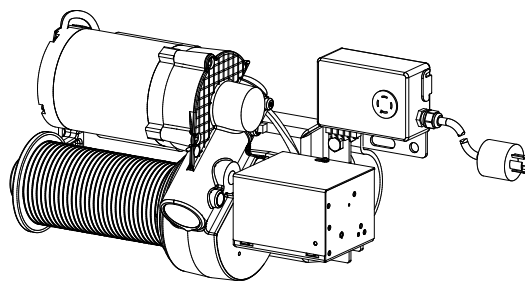

503060 with Motorized Backstop Winch

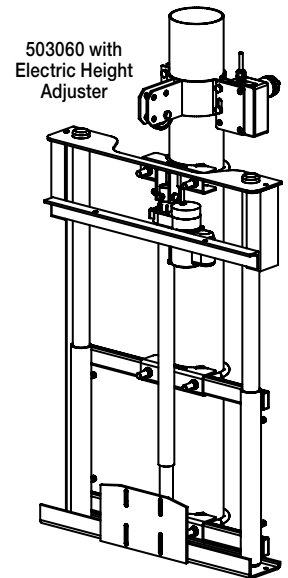

503060 with Electric Height Adjuster

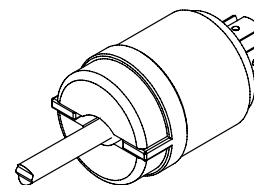
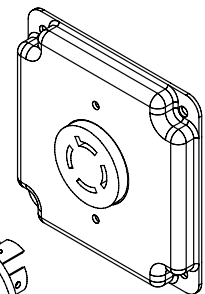

If you have any difficulties installing or servicing your EZ-Pad Plus® Control System, call your dealer or Draper, Inc.

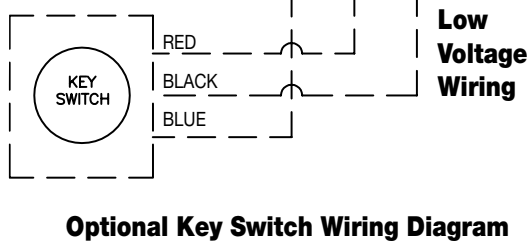
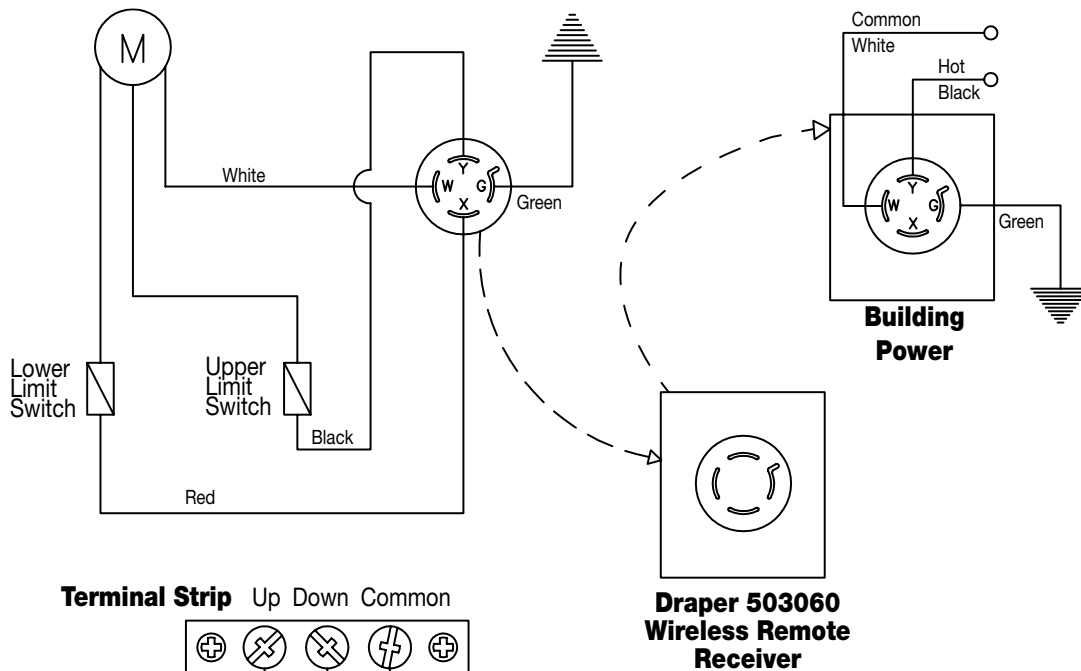

Attaching Optional Key Switch to Wireless Remote Receiver

Draper's No. 503060 EZ Power Wireless Remote Control Receiver is capable of having dual methods of operation. You can attach an optional low voltage backup key switch, in addition to being normally operated with the No. 503061 99-Station Transmitter.

In order to connect the optional key switch, the electrician will need to pull a three-conductor control wire between the switch location and the wireless receiver. The connections between the key switch and the terminal block located on the outside of the receiver housing should be made per the following diagram.

Programming Receiver Frequency

- 1 Open dipswitch cover on end of 503060 Wireless Remote Receiver/Operator. Cover opens by loosening outer screw and rotating cover.
- 2 Locate the dipswitch bank inside receiver and set the dipswitches per the following chart, then close dipswitch access cover.
A switch is in ON when in the down position (*toward the mounting plate*).

