

# Elements Of Design

## Decorative Grade Grab Bar Installation

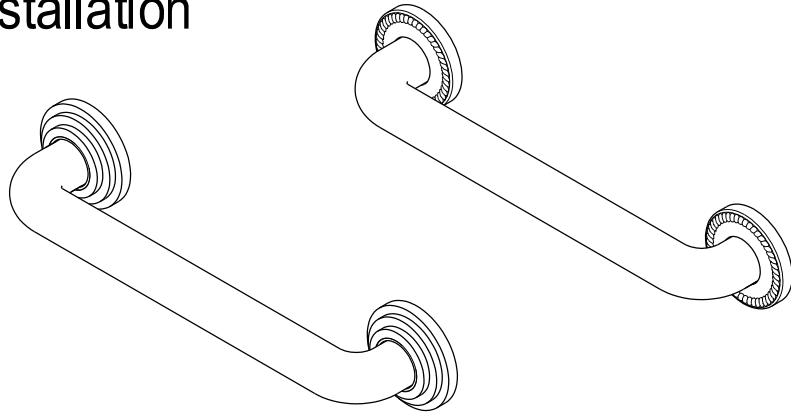

### Parts:

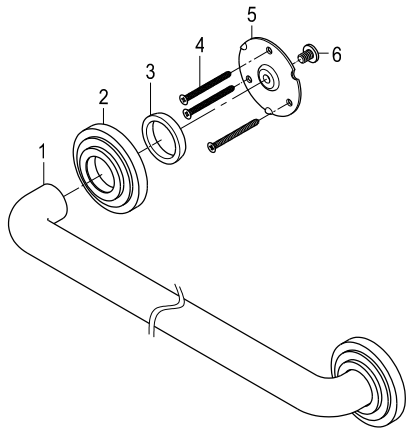

### Parts Information:

- 1) Bar: 1 Pc
- 2) Decorative Flange: 2 Pcs
- 3) Friction Washer: 2Pcs
- 4) Mounting Screw: 6 Pcs
- 5) Mounting Plate: 2 Pcs
- 6) Set Screw: 2 Pcs

### Replacement Parts:

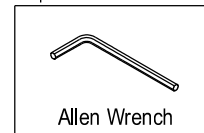

## TOOLS REQUIRED



Flathead Screwdriver



Phillips Screwdriver



Marking Pencil



Power Drill

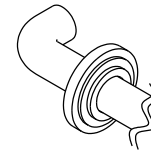

Fig. 1

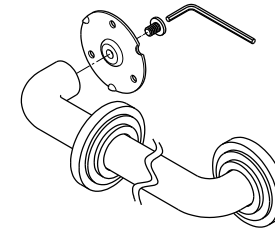

Fig. 2

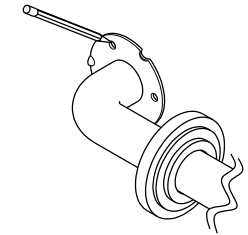

Fig. 3

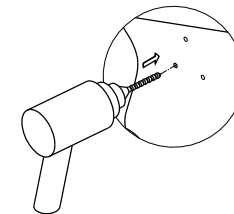

Fig. 4

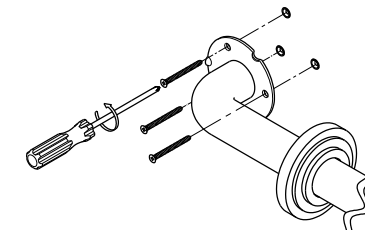

Fig. 5

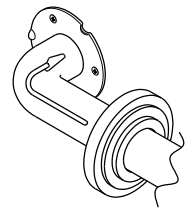

Fig. 6

### Cleaning

Clean with a damp cloth only. Avoid using metal or abrasive polishes.

### Installation Steps:

1. Insert decorative flange. Make sure that underside is facing towards the end of the grab bar, insert cap onto end of grab bar.
2. Attach mounting plate and secure by threading Allen bolt. (included)
3. Locate position on the wall and mark location of the holes.
4. Drill Starter holes. (5/64")
5. Mount grab bar to the wall using 2" screws. (Enclosed)

This grab bar is designed to be installed on wood bracing, if a proper wood bracing is not available consult your contractor as to the best anchors to use for your specific application some options available are Tile/ masonry anchors, toggle bolts, plastic anchors, metal anchors and drywall anchors.

www.eodfaucet.com

TOLL-FREE CUSTOMER SERVICE: 877-FAUCET-1(328-2381)

TECHNICAL SUPPORT E-mail: info@eodfaucet.com

12775 Reservoir St., Chino, CA 91710