

**Parts:**

**Replacement Parts:**

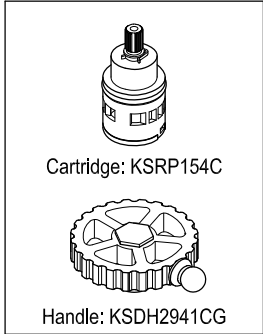
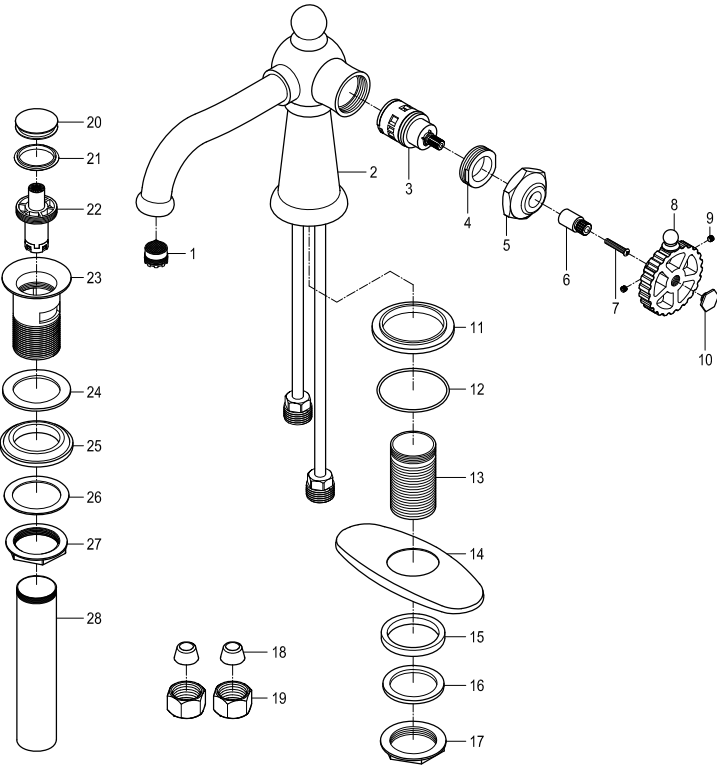

# KINGSTON

KITCHEN & BATH

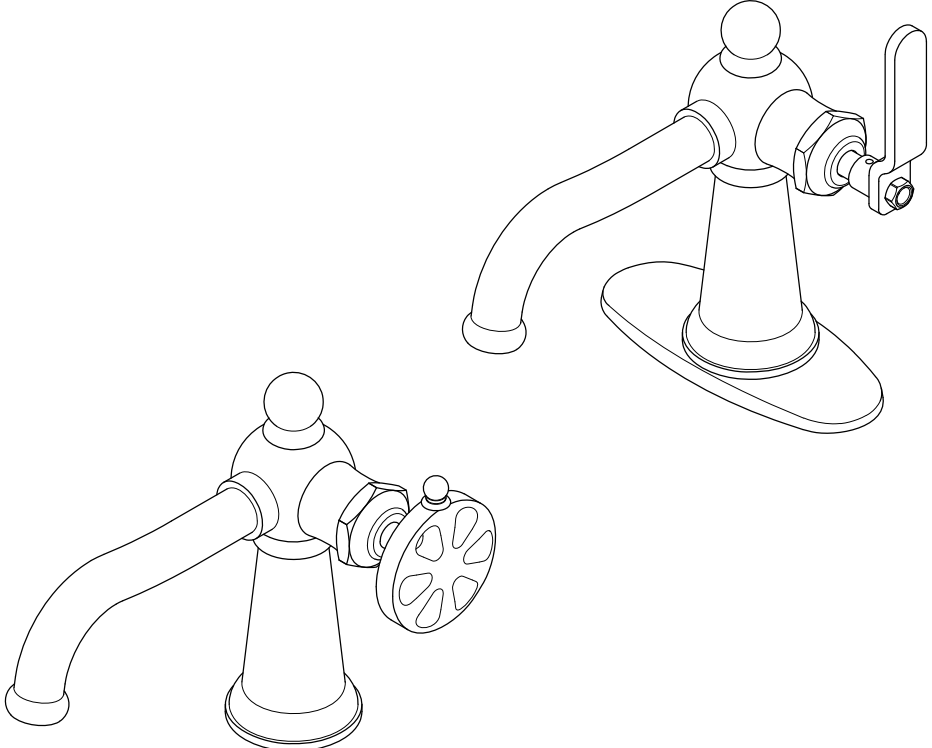

**CARE AND MAINTENANCE OF YOUR FAUCET**

Your Kingston Brass faucet has been finished to the most strict standards; however, due to the high content of minerals in the water, your finish may appear dull and tarnished after time. These are some do's and don'ts to maintain the luster on your faucet for many years to come.

- DO**
1. Use a silicon based caulking when installing.
  2. Clean your faucet with only a mild soap and water solution.
  3. Dry your faucet after using it.
  4. Give it a coat of Carnauba Wax periodically.

- DON'T**
1. Use plumbers putty when installing the faucet.
  2. Use any abrasive cleaning agents.

It may seem like a very simple and short list but it is that simple to maintain your faucet, looking shiny and new.

If your faucet is already looking somewhat dull and tarnished, before replacing it, try cleaning it with a 50/50 solution of vinegar and water, you may need to soak some rags and wrap around those stubborn areas, leave overnight and rinse completely in the morning, apply Carnauba wax once you have removed the mineral deposits.

**Parts:**

Washer & Lock Nut	Cone Washer & Coupling Nut	Push Drain
1 Pc	2 Pcs	1 Pc

**NOTICE**

Failure to follow all directions may cause leaks which may result in water damage

www.kingstonbrass.com  
 TOLL-FREE CUSTOMER SERVICE: 1-877-2-KBRASS  
 TECHNICAL SUPPORT E-mail: service@kingstonbrass.com  
 12775 Reservoir Street, Chino, CA 91710

# KINGSTON

KITCHEN & BATH

## INSTALLATION INSTRUCTIONS

### Single Handle Lavatory Faucet with Push Drain

#### BEFORE BEGINNING INSTALLATION:

1. Flush plumbing lines to clear any debris.
2. Shut off both supply lines after flushing.

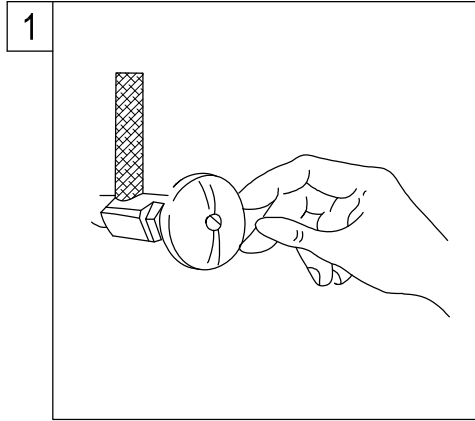

1. Shut off hot and cold water supply under sink. Plug sink drain with cloth to avoid losing small parts. Remove old faucet.

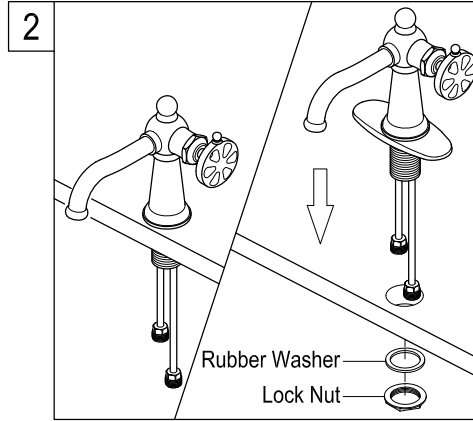

2. Place optional escutcheon or flange on bottom of new faucet before position faucet through mounting hole. Secure the faucet to sink by installing rubber washer and lock nut onto it. Tighten with wrench.

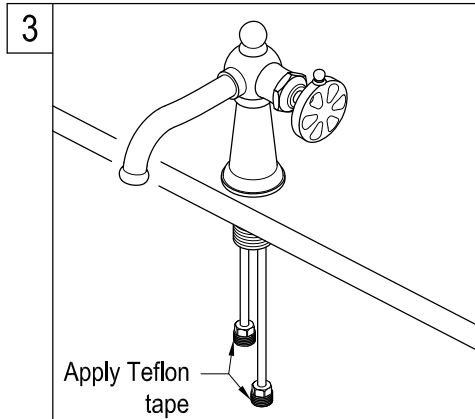

3. Apply Teflon tape to inlet shanks and connect supply lines.

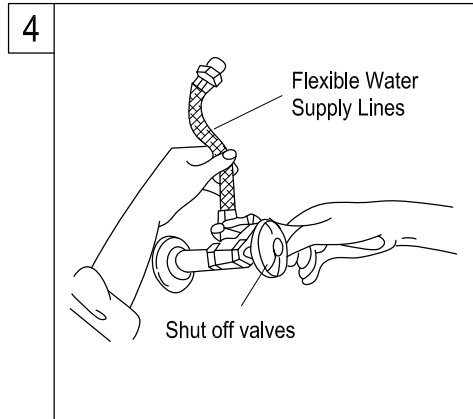

4. Apply Teflon tape to threads on faucet shank and shut off valves, connect water supply line.

#### Need Tools:

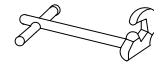

Basin Wrench

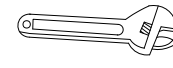

Adjustable Wrench



Teflon Tape

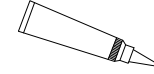

Silicone Sealant

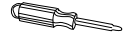

Screwdriver

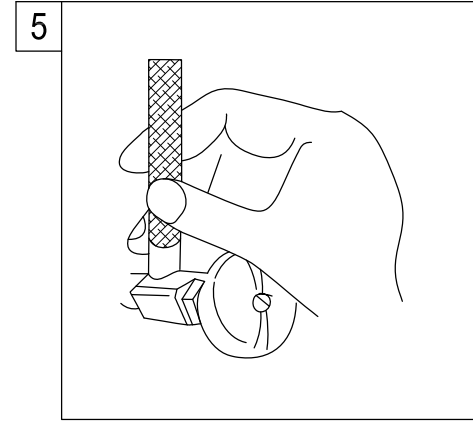

5. Turn on water supply valves and check for leaks, especially all supply line connections.

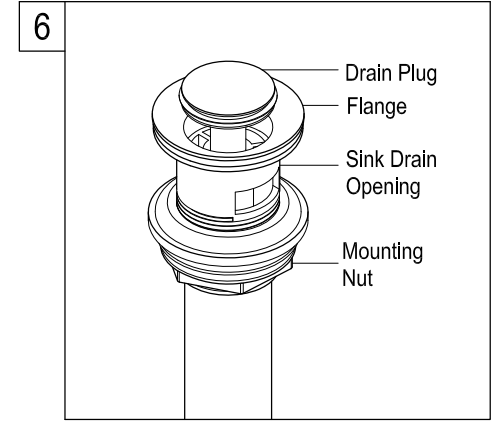

6. Install drain body up through the drain opening and reattach the flange onto drain body. Holding the drain body in position with overflow facing the position of sink overflow hole and hand tighten the mounting nut.

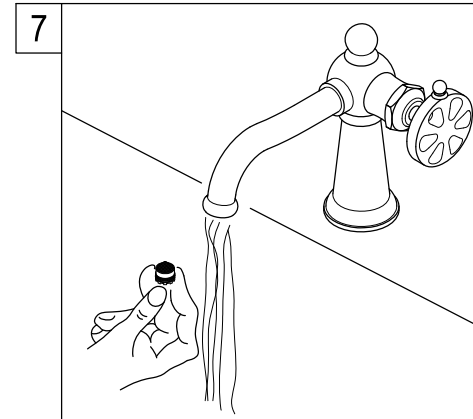

7. Remove aerator with a coin, turn on both hot and cold water valve and let water run for at least one minute. This will clear any debris left in the line then reinstall aerator.

#### Warning!!!

- Do not over-tighten nut during installation.
- Over-tighten may crack the valve and cause severe leak.