

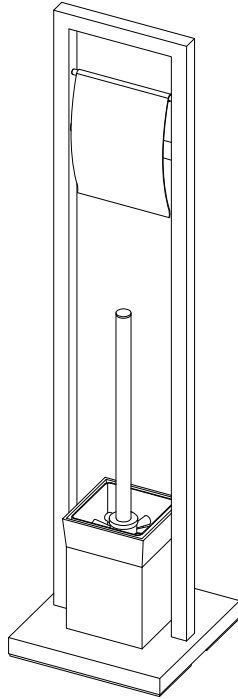



KINGSTON

KITCHEN & BATH

Pedestal Toilet Paper with Brush Holder Installation

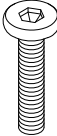
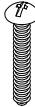

Parts:

Bolt	Screw	Washer	Spring Washer	Bar
				
2 Pcs	1 Pc	3 Pcs	2 Pcs	1 Pc

www.kingstonbrass.com
 TOLL-FREE CUSTOMER SERVICE: 1-877-2-KBRASS
 TECHNICAL SUPPORT E-mail: service@kingstonbrass.com
 12775 Reservoir Street, Chino, CA 91710

TOOLS REQUIRED



Allen Wrench

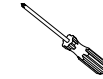

Phillips Screwdriver

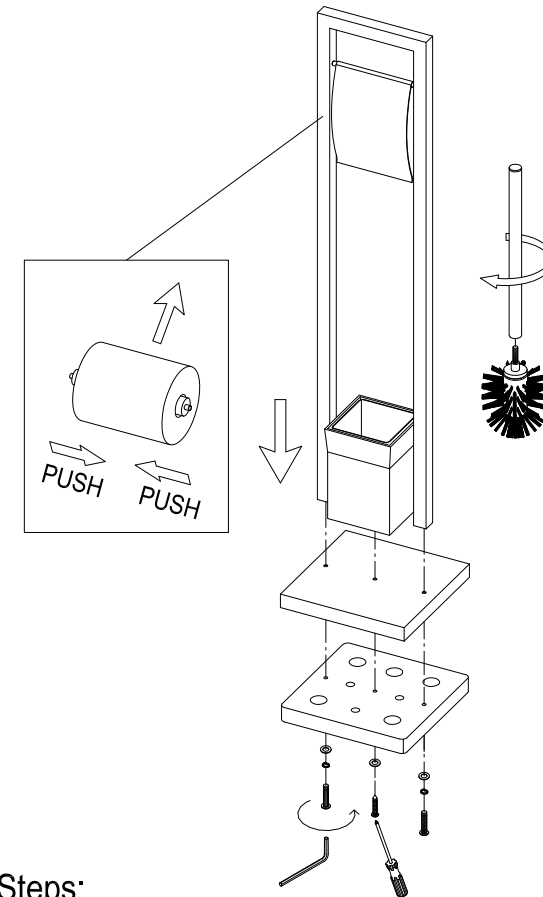

Installation Steps:

- Step 1. Place the base on a flat level surface, and install toilet paper holder assembly to the bottom base plate.
Tighten with spring washers, washers and bolts using Allen Wrench.
- Step 2. Install the brush holder onto the base, secure with washer and screw using a Phillips screwdriver.
- Step 3. Assemble brush holder by threading column to the brush. Insert the brush to the holder.
- Step 4. Slip the toilet paper into roller and attach the roller to the toilet paper holder.

Cleaning

Clean with a damp cloth only.
 Avoid using metal or abrasive polishes.