

Post Anchors

User Instruction Manual

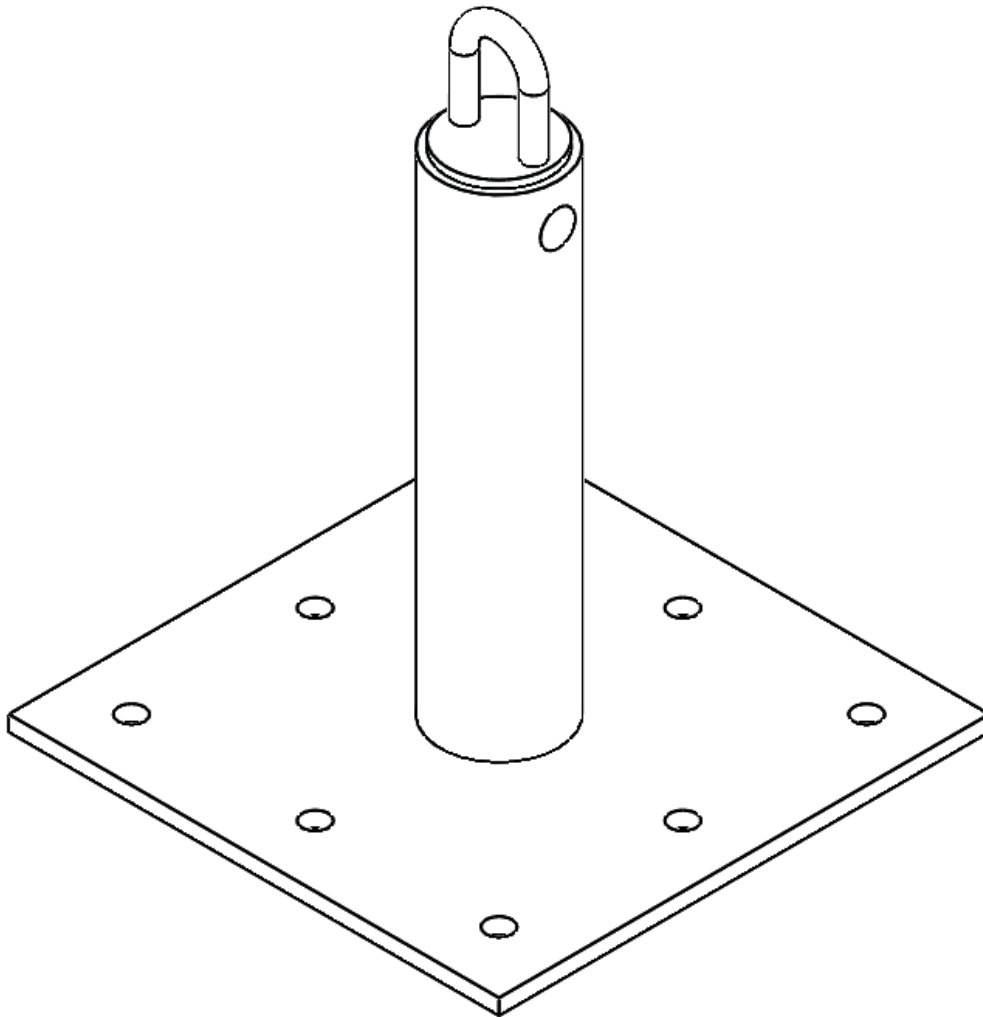

This manual is intended to meet the Manufacturer's Instructions as required by the American National Standards Institute (ANSI) Z359 and should be used as part of an employee training program as required by the Occupational Safety and Health Administration (OSHA).

Table of Contents

| | | |
|-----|--|----|
| 1.0 | Warnings and Important Information | 3 |
| 2.0 | Description | 4 |
| 3.0 | Application | 4 |
| 4.0 | System Requirements | 5 |
| 5.0 | Installation | 6 |
| 6.0 | Maintenance, Service and Storage | 9 |
| 7.0 | Inspection | 9 |
| 8.0 | Labels | 11 |
| 9.0 | Definitions | 12 |
| | Appendix A | 14 |

For purposes of this manual, the FallTech® Post Anchors in all iterations may be referred to collectively as the Post Anchor, the Anchor, the anchorage connector, the equipment, the product, or the unit.

1.0 Warnings and Important Information

WARNING

- Avoid moving machinery, thermal, electrical, and/or chemical hazards as contact may cause serious injury or death.
- Avoid swing falls.
- Follow the weight restrictions and recommendations in this manual.
- Remove from service any equipment subjected to fall arrest forces.
- Remove from service any equipment that fails inspection.
- Do not alter or intentionally misuse this equipment.
- Consult FallTech when using this equipment in combination with components or subsystems other than those described in this manual.
- Do not connect rebar hooks, large carabiners, or large snap hooks to the FBH dorsal D-rings as this may cause a roll-out condition and/or unintentional disengagement.
- Avoid sharp and/or abrasive surfaces and edges.
- Use caution when performing arc welding. Arc flash from arc welding operations, including accidental arcs from electrical equipment, can damage equipment and are potentially fatal.
- Examine the work area. Be aware of the surroundings and workplace hazards that may impact safety, security, and the functioning of fall arrest systems and components.
- Hazards may include but not be limited to cable or debris tripping hazards, equipment failures, personnel mistakes, moving equipment such as carts, barrows, fork lifts, cranes, or dollies. Do not allow materials, tools or equipment in transit to contact any part of the fall arrest system.
- Do not work under suspended loads.

IMPORTANT

This product is part of a personal fall arrest, restraint, work positioning, suspension, or rescue system. A Personal Fall Arrest System (PFAS) is typically composed of an anchorage and a Full Body Harness (FBH), with a connecting device, i.e., an Energy Absorbing Lanyard (EAL), or a Self-Retracting Device (SRD), attached to the dorsal D-ring of the FBH.

These instructions must be provided to the worker using this equipment. The worker must read and understand the manufacturer's instructions for each component or part of the complete system. Manufacturer's instructions must be followed for proper use, care, and maintenance of this product. These instructions must be retained and be kept available for the worker's reference at all times. Alterations or misuse of this product, or failure to follow instructions, may result in serious injury or death.

A Fall Protection Plan must be on file and available for review by all workers. It is the responsibility of the worker and the purchaser of this equipment to assure that users of this equipment are properly trained in its use, maintenance, and storage. Training must be repeated at regular intervals. Training must not subject the trainee to fall hazards.

Consult a doctor if there is reason to doubt your fitness to safely absorb the shock of a fall event. Age and fitness seriously affect a worker's ability to withstand falls. Pregnant women or minors must not use this equipment.





Heavy users experience more risk of serious injury or death due to falls because of increased fall arrest forces placed on the user's body. In addition, the onset of suspension trauma after a fall even may be accelerated for heavy users.

The user of the equipment discussed in this manual must read and understand the entire manual before beginning work.

NOTE: For more information consult the ANSI Z359 body of standards.

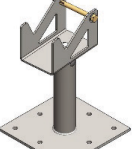
2.0 Description

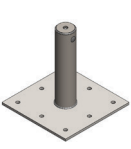
The FallTech® Post Anchors are single anchor point anchors available in 12" and 18" heights with two bases sizes and four different top configurations. Top configurations include, a Swivel D-Ring, an SRL Cradle, a Welded Eye, and a Threaded Hole with a 5/8"-11 thread. A weld on post is available for weld-on applications. See Figure 1 for details.

| Figure 1 - About FallTech® Post Anchors | | | | | | |
|---|---|---|---|---|---|---|
| Image |  |  |  |  |  |  |
| Top | Swivel D-Ring | SRL Cradle | Welded Eye | Threaded Hole | Welded Eye | Threaded Hole |
| Height | 12" or 18" | | | | 12" or 18" | |
| Base | Bolt-on 12" x 12" or 16" x 16" | | | | Weld-On | |

Base sizes are 12" x 12" for concrete and bolt-on steel mounting and the 16" x 16" base can be used in concrete, steel, and wood applications, see Figure 2. Backing plates are also available. For base hole pattern specifications, see Appendix A.

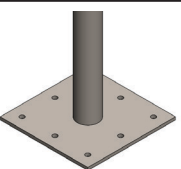
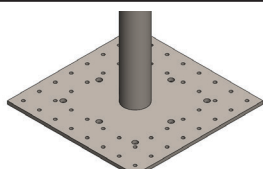
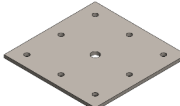
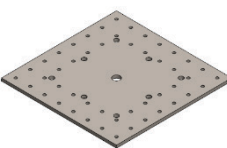
| Figure 2 - About FallTech® Post Anchor Bases | | | | |
|--|---|---|--|---|
| Image |  |  |  |  |
| Base | 12" x 12" x 3/8" | 16" x 16" x 3/8" | 12" x 12" x 3/8" | 16" x 16" x 3/8" |
| Usage | Concrete, Steel | Concrete, Steel, Wood | Backing Plate | |

WARNING

Be sure to read, understand, and follow all instructions and warnings in this manual. Any misuse could result in serious injury or death.

3.0 Application

3.1 Purpose: The FallTech® Post Anchors are designed to be used as a component in a Personal Fall Arrest System (PFAS), to provide a combination of worker mobility and fall protection as required for inspection work, general construction, maintenance work, oil production, confined space work, etc.

3.2 Personal Fall Arrest System: A PFAS is typically composed of an anchorage and a FBH, with an energy absorbing connecting device, i.e., a EAL, an SRD, or a Fall Arrestor Connecting Subsystem (FACSS), attached to the dorsal D-ring of properly fitted and adjusted FBH. All uses and applications of a FBH with this equipment requires the FBH to be properly fitted and adjusted to the user. Failure to properly fit the FBH to the user could result in serious injury or death.

3.3 Application Limits: The FallTech® Post Anchors are a dynamic anchorage subsystem that varies in its performance depending upon the length of the system and the type of PFAS system used. Care should be taken to understand the capacity of the system, anchorage strength requirements, total allowable free fall, and the requirements how the user's PFAS deploys during a fall event. The longer the freefall, the greater the energy in the system and will result in more significant clearance requirements and impact forces on the body. Take action to avoid sharp edges, abrasive surfaces, and thermal, electrical, and chemical hazards.

3.4 Approved Applications: Below are applications for which all FallTech® Post Anchors are specifically suited. This list is not all-inclusive, but is intended to anticipate the most common applications in which this product may be used.

3.4.1 Personal Fall Arrest: The FallTech® Post Anchors used as the anchorage component of a PFAS to protect the user in the event of a fall. PFAS typically consists of an anchorage, a Full Body Harness (FBH), and a deceleration device such as a Energy Absorbing Lanyard (EAL) or Self Retracting Device (SRD). Maximum permissible free fall is 6 ft (1.8 m).

3.4.2 Restraint: The FallTech® Post Anchors may be used as a component of a restraint system to prevent the user from reaching a fall hazard. Restraint systems typically include a full body harness containing a body belt and a lanyard or restraint line.

3.4.3 Work Positioning: The FallTech® Post Anchors may be used as a component of a work positioning system to support the user at a work position. Work positioning systems typically include an FBH with integrated side D-rings, a body belt, and a positioning lanyard. A back up PFAS is required when the user is exposed to a free fall of 2 ft (1.8 m) or more.

3.4.4 Rescue: The FallTech® Post Anchors may be used as an anchor in rescue operations that require specialized equipment beyond the scope of this manual.







4.0 System Requirements

4.1 Capacity: The Post Anchors covered in this manual are ANSI compliant, with a listed single user capacity of up to 310 lbs., including clothing, tools, etc., and OSHA compliant, with a listed single user capacity of up to 425 lbs, including clothing, tools, etc. See Appendix A for capacity information. No more than one PFAS may be connected to a Post Anchor at one time.

4.2 Compatibility of Connectors: Connectors are considered to be compatible with connecting elements when they have been designed to work together in such a way that their sizes and shapes do not cause their gate mechanisms to open inadvertently regardless of how they become oriented. Contact FallTech® if you have any questions about compatibility. Connectors must be compatible with the anchorage or other system components. Do not use equipment that is not compatible. Non-compatible connectors may unintentionally disengage. Connectors must be compatible in size, shape, and strength. Self-closing, self-locking connectors are required by ANSI, CSA, and OSHA.

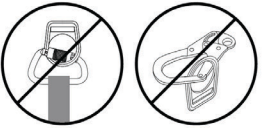
4.3 Making Connections: Only use self-locking connectors with this equipment. Only use connectors that are suitable to each application. Ensure all connections are compatible in size, shape, and strength. Do not use equipment that is not compatible. Visually ensure all connectors are fully closed and locked. Connectors (snap hooks, rebar hooks, and carabiners) are designed for use only as specified in this manual.

Figure 3 - Non-Compatible Connections

| | |
|--|--|
|    | <p>A Never connect two active components (snap hooks or carabiners) to each other.</p> |
| | <p>B Never connect two active components (snap hooks or carabiners) to a single D-ring at the same time.</p> |
| | <p>C Never connect in a way that would produce a condition of loading on the gate.</p> |
| | <p>D Never attach to a object in a manner whereby the gate (of the snap hook or carabiner) would be prevented from fully closing and locking. Always guard against false connections by visually inspecting for closure and lock.</p> |
|    | <p>E Never attach explicitly to a constituent subcomponent (webbing, cable or rope) unless specifically provided for by the manufacturer's instructions for both subcomponents (snap hook or carabiner and webbing, cable or rope).</p> |
| | <p>F Never attach in a manner where an element of the connector (gate or release lever) may become caught on the anchor thereby producing additional risk of false engagement.</p> |
| | <p>G Never attach a spreader snap hook to two side/positioning D-rings in a manner whereby the D-rings will engage the gates; the gates on a spreader must always be facing away from the D-rings during work positioning.</p> |

4.5 Personal Fall Arrest System: PFAS used with this equipment must meet ANSI Z359 requirements. A full body harness must be worn when this equipment is used as a component of a PFAS. As required by OSHA, the personal fall arrest system must be able to arrest the user's fall with a maximum arresting force of 1,800 lbs (8 kN), and limit the free fall to 6 ft (1.8 m).

4.6 Structure Mounting Strength: The structure and mounting hardware must be capable of withstanding a 60,000 in-lbs (6,779 N m) moment and a 5,000 lbf (2268 kg) vertical load for the 12" Post Anchor or a 90,000 in-lbs (10,169 N m) moment and a 5,000 lbf (2,268 kg) vertical load for the 18" Post Anchor. Installations MUST comply with local regulation standards and be approved by a Qualified Person before use.

Select an anchorage location carefully. Consider structural strength, obstructions in the fall path, and swing fall hazards. In certain situations, the qualified person can determine that a given structure is able to withstand the applied MAF of the PFAS with a safety factor of at least two.

5.0 Installation

WARNING

Do not alter or intentionally misuse this equipment. Consult FallTech® when using this equipment in combination with components or subsystems other than those described in this manual. All components or subsystems used with the anchors discussed in this manual must be in compliance with ANSI Z359.

Take action to avoid sharp and/or abrasive surfaces and edges when possible.

5.1. Plan the Personal Fall Arrest System (PFAS): Examine the work area and take action to address hazards. Falls are a serious hazard when working at height. Training and equipment are the tools of fall hazard management. There are several closely related facets of fall hazard management with a PFAS;

- Anchorage
- Minimum Required Fall Clearance (MRFC)
- Swing Fall and Expanded Work Zone
- Overhead (above the FBH D-ring) Anchorage
- Non-overhead (below the FBH D-ring) Anchorage
- Rescue Plan

5.2 Structure: Select a suitable mounting structure. See Paragraph 4.6.

5.3 Minimum Required Fall Clearance: The MRFC is the minimum distance a user needs between himself and the nearest obstruction (or ground) below the walking/working surface to avoid serious injury or death in case of a fall event. The user of this equipment must determine the MRFC for units discussed in this manual to ensure adequate clearance exists in the fall path.

5.4 Swing Fall: A swing fall occurs when the worker moves laterally out from under the anchor and creates an expanded work zone condition. If a fall event occurs, the worker would swing back toward the anchorage. The swinging action generates considerable force, and if the worker strikes an obstruction or the lower level, this force could cause severe injury or death.

5.5 Pre-Use Inspection: FallTech® requires that the following steps be taken during inspection prior to each use of this Post Anchor:

1. Inspect the Post Anchor thoroughly for damage; inspection should include checking for corrosion, dents, cracks, deformed, or bent tubing, and welded areas for cracks.
2. Inspect the additional equipment used on the Post Anchor per the user instruction manual for the specific equipment. Do not use if the equipment fails inspection.
3. Inspect all hardware for damage, excessive wear, corrosion, or missing parts.

Do not use the FallTech Post Anchor or additional equipment if it fails any part of this inspection.

5.5 Concrete Installation: FallTech® requires that the following steps be taken during the installation of this Post Anchor.

Minimum Concrete Requirements: 6" thick, 3,000 PSI.

Fasteners: Hilti HSL-3 M10 Expansion Bolts or equivalent, if approved by Qualified Person or Professional Engineer.

Edge Distance: Edge setback in installation location substrate as designed and approved by Qualified Person or Professional Engineer.

Follow the manufacturer's instructions for the installation of fasteners. Install 8 fasteners as shown in on Figure 4.

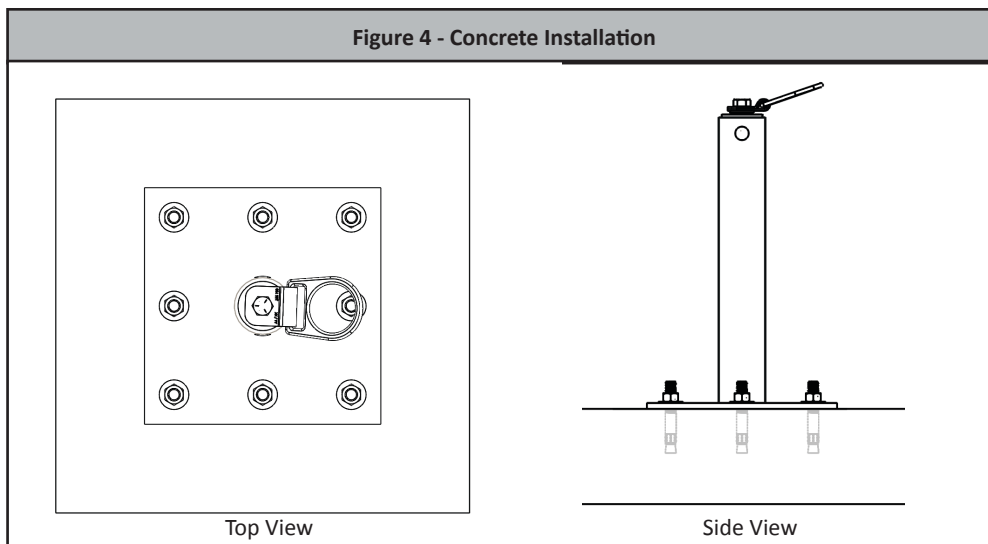

5.6 Steel I-Beam with Backer Plate: FallTech® requires that the following steps be taken during the installation of this Post Anchor.

Fasteners: 1/2" ASTM A307 Gr A Zinc Plated Low Carbon Steel Threaded Rod cut to length or equivalent, if approved by a Qualified Person or Professional Engineer, a minimum of 8 each 1/2" Lock Washers, and 8 each 1/2" Hex Nuts.

Install a minimum of 4 threaded rods as shown on Figure 5. Torque evenly to 35 ft-lbs.

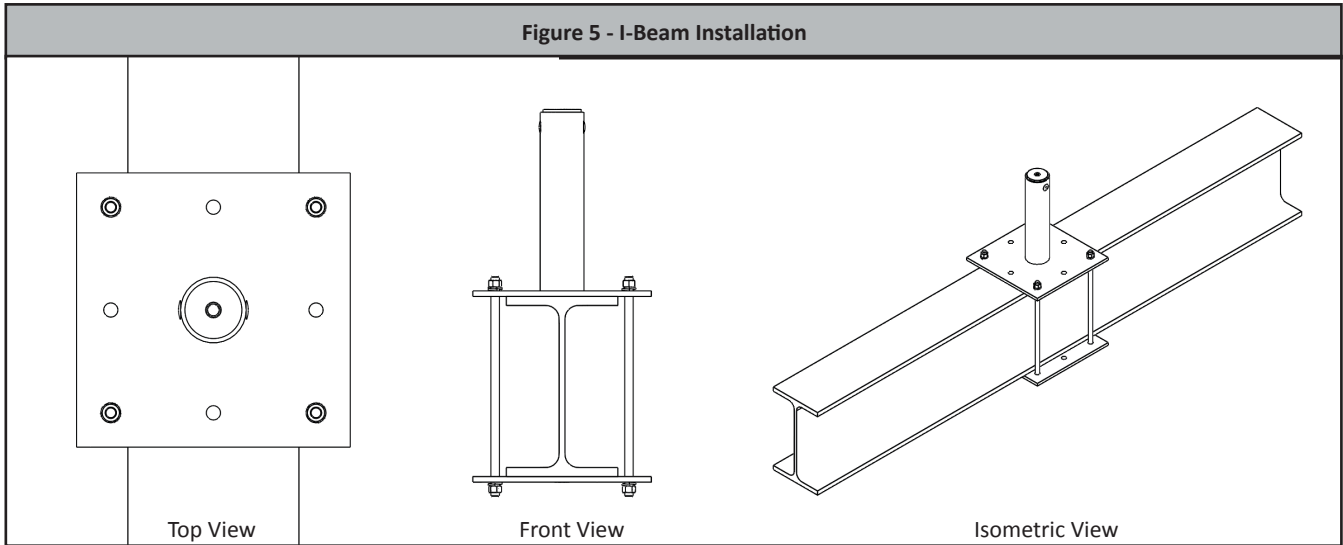

5.7 Weld-On Installation: FallTech® requires that the following steps be taken during the installation of this Post Anchor.

Minimum Beam Flange Width: 4"

Minimum Weld Bead: 5/16" Fillet All Around

Weld must be performed by a AWS certified welder in accordance with all applicable regulations and approved by a Qualified Person.

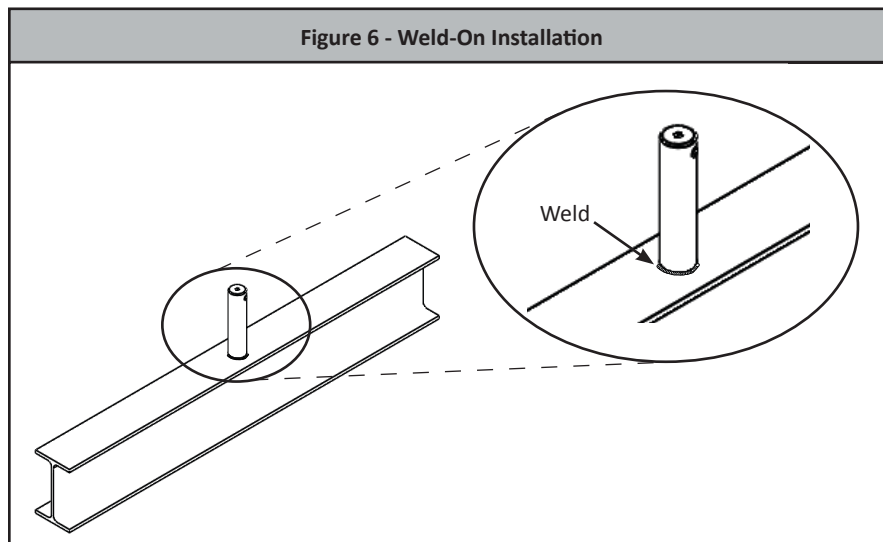

5.8 Wood Installation: FallTech® requires that the following steps be taken during the installation of this Post Anchor.

Wood installations require additional supports to the structure to provide added strength necessary in the event of a fall. Below are guidelines for a Post Anchor installation on a wood roof. All wood installations must be approved by a Qualified Person or a Professional Engineer.

Minimum Wood Requirements: 3/4" thick CDX plywood under 5/8" plywood roof sheathing. Provide four 2" x 6" support blocks

Fasteners:

1. #14-10 x 3" length Grade 8 Screws for Post Anchor Base Plate.
2. #14 x 3" length screws for each truss.
3. #14 x 2" length screws for wood deck.

1. Measure and cut four 2" x 6" Support Blocks and fasten, as shown in Figure 7.

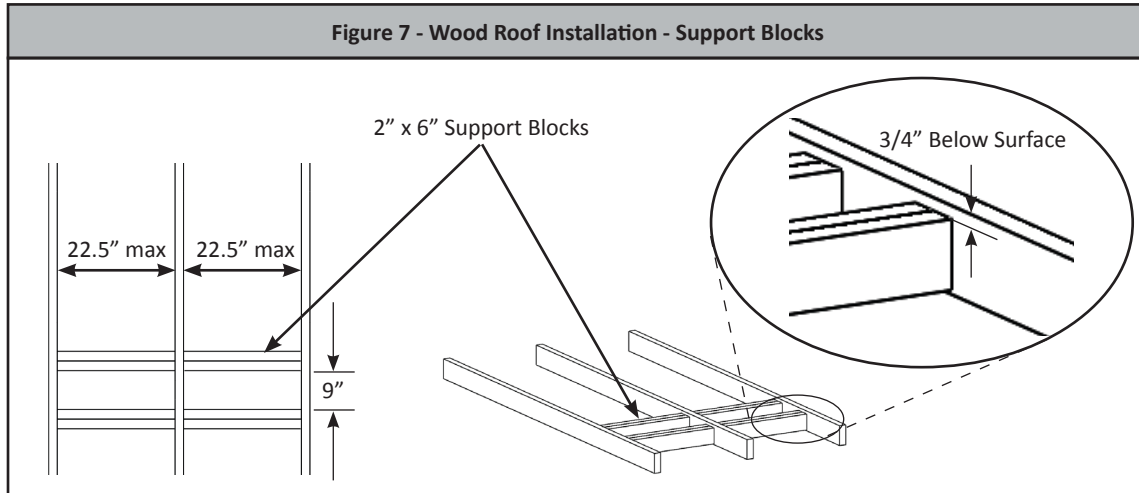

2. Measure and cut two 3/4" CDX plywood sheets and place them onto the Support Blocks, see Figure 8.

3. Measure and cut one 5/8" plywood roof sheathing 48" long and place over the two CDX plywood sheets, see Figure 9.

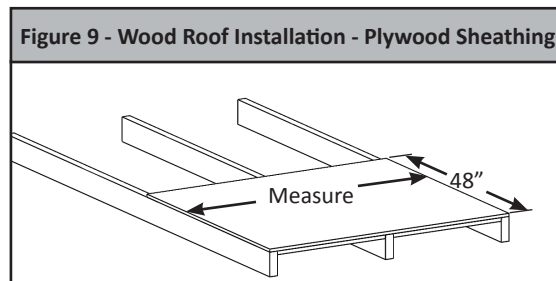
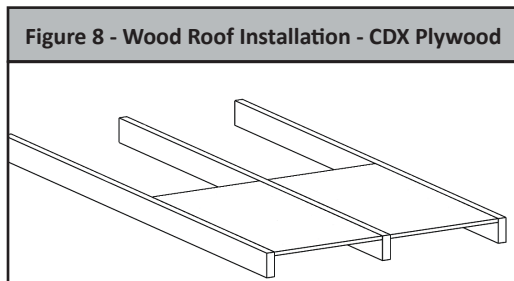

4. Install thirty-three #14 x 3" screws, eleven screws on each truss, 4" apart; see the circle locations in Figure 10.

5. Install thirty-six #14 x 2" screws onto the wood deck, 8" apart; see the square locations in Figure 10.

6. Install the Post Anchor using forty #14-10 x 3" screws; see the hexagonal locations in Figure 11.

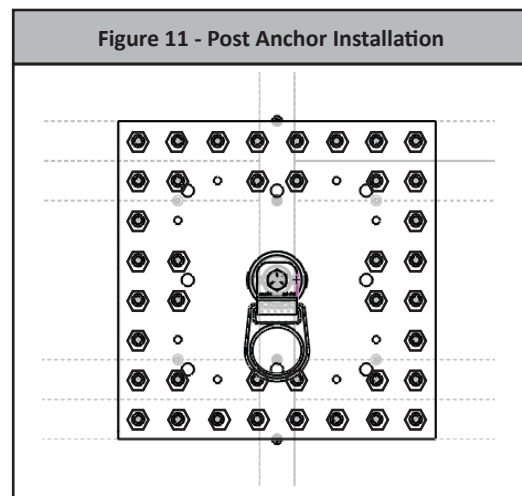
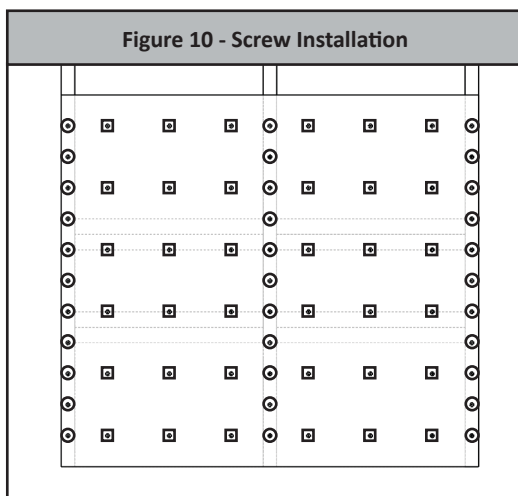

6.0 Maintenance, Service, and Storage

- Maintenance:** No scheduled maintenance is required, other than the replacement of items that failed inspection.
- Service:** There are no specific service requirements for this system component.
- Storage:** If the unit is removed from its installation location, it should be stored in a dry area free of corrosive elements that may harm or cause the product not to function.

7.0 Inspection

7.1 Pre-Use Inspection: Please review the Pre-Use Inspection guidelines in Section 5.5 for inspection requirements.

7.2 Inspection Frequency: FallTech requires all fall protection equipment to be inspected by a competent person other than the user at least once each year or more frequently if the conditions exist. FallTech strongly recommends that a competent person conducts a hazard assessment of the environment and determines the length of the inspection intervals due to the site conditions. The annual inspection shall be recorded on an inspection log, including all deficiencies. This inspection should also be used as an opportunity to train any authorized persons with respect to deficiencies that they have failed to observe on their daily inspections.

| Inspection Frequency | | | | |
|--------------------------|--|---|-----------------------------|---------------------------------------|
| Type of Use | Application Examples | Example Conditions of Use | Worker Inspection Frequency | Competent Person Inspection Frequency |
| Infrequent to Light Use | Rescue and confined space, factory maintenance | Good storage conditions, indoor or infrequent outdoor use, room temperature, clean environments | Before each use | Annually |
| Moderate to Heavy Use | Transportation, residential construction, utilities, warehouse | Fair storage conditions, indoor and extended outdoor use, all temperatures, clean or dusty environments | Before each use | Semi-annually to annually |
| Severe to Continuous Use | Commercial construction, oil and gas, mining, foundry | Harsh storage conditions, prolonged or continuous outdoor use, all temperatures, dirty environments | Before each use | Quarterly to semi-annually |

7.3 Inspection Results: If an inspection reveals defects in or damage to the equipment, inadequate maintenance, or activated fall indicators, remove the equipment from service.

7.4 Inspection Document: Record inspection results on the Inspection Record provided below or on a similar document.

Inspection Record

Model #: _____ Serial #: _____ Date of Manufacture: _____

| INSPECTION DATE | INSPECTOR | COMMENTS | PASS/FAIL | CORRECTIVE ACTION NEEDED | APPROVED BY |
|--------------------|-----------|----------|-----------|--------------------------|-------------|
| | | | | | |
| | | | | | |
| | | | | | |
| | | | | | |
| | | | | | |
| | | | | | |
| | | | | | |
| | | | | | |
| | | | | | |
| | | | | | |
| | | | | | |
| | | | | | |
| | | | | | |
| | | | | | |

8.0 Labels

The labels must be present and legible.

FALLTECH®

800-719-4619 falltech.com

Material: Steel
 Meets: ANSI Z359.18-2017 Type D for Steel and Concrete
 Meets: OSHA 1926.502 for Wood, Steel, and Concrete
 Minimum Service Temperature: +10°F
 Minimum Breaking Strength (MBS): 5,000 lbs.

⚠ WARNING

All Manufacturer's instructions, labels, and warnings must be read before use and followed at all times for proper use, maintenance, and inspection. Users must be fully trained and knowledgeable about all government and regulatory requirements applicable to workplace safety. This equipment must be installed and used under the supervision of a qualified person. Failure to follow instructions or misuse of this product may result in serious injury or death. Exercise caution using this equipment near hazardous thermal, electrical, or chemical sources. Avoid contact with sharp edges, abrasive surfaces, chemicals, salt water, acids, and alkalines. See instructions for loading direction diagram and restrictions on use with components, subsystems, or systems with which this product is designed to be used. Inspect the system before each use, following guidelines found in the user instruction manual supplied with product at time of shipment. Do not use system if unsafe conditions are present. Remove from service if equipment is subjected to fall arrest forces. Always log inspection results in user manual and on inspection grid label.

MARK ON DATE GRID A) INITIAL SERVICE DATE
 B) DATE OF PASSED INSPECTION : IF UNIT FAILS INSPECTION REMOVE IT FROM SERVICE

| YEAR | J | F | M | A | M | J | J | A | S | O | N | D |
|------|---|---|---|---|---|---|---|---|---|---|---|---|
| | | | | | | | | | | | | |
| | | | | | | | | | | | | |
| | | | | | | | | | | | | |
| | | | | | | | | | | | | |

Model#:
 Date of Mfr:
 Serial #:

412-05069 Rev A

DO NOT REMOVE LABEL

MANC33 Rev B

020320

11

9.0 Definitions

The following are general definitions of fall protection terms as defined by ANSI Z359.0-2012.

Anchorage - A secure connecting point or a terminating component of a fall protection system or rescue system capable of safely supporting the impact forces applied by a fall protection system or anchorage subsystem.

Anchorage Connector - A component or subsystem that functions as an interface between the anchorage and a fall protection, work positioning, rope access or rescue system for the purpose of coupling the system to the anchorage.

Arrest Distance - The total vertical distance required to arrest a fall. The arrest distance includes the deceleration distance and activation distance.

Authorized Person - A person assigned by the employer to perform duties at a location where the person will be exposed to a fall hazard.

Available Clearance - The distance from a reference point, such as the working platform, to the nearest obstruction that an authorized person might contact during a fall which, if struck, could cause injury.

Capacity - The maximum weight that a component, system or subsystem is designed to hold.

Certification - The act of attesting in writing that the criteria established by these standards or some other designated standard have been met.

Certified Anchorage - An anchorage for fall arrest, positioning, restraint or rescue systems that a qualified person certifies to be capable of supporting the potential fall forces that could be encountered during a fall.

Clearance - The distance from a specified reference point, such as the working platform or anchorage of a fall arrest system, to the lower level that a worker might encounter during a fall.

Clearance Requirement - The distance below an authorized person that must remain clear of obstructions in order to ensure that the authorized person does not make contact with any objects that would cause injury in the event of a fall.

Competent Person - An individual designated by the employer to be responsible for the immediate supervision, implementation and monitoring of the employer's managed fall protection program who, through training and knowledge, is capable of identifying, evaluating and addressing existing and potential fall hazards, and who has the employer's authority to take prompt corrective action with regard to such hazards.

Component - An element or integral assembly of interconnected elements intended to perform one function in the system.

Connecting Subsystem - An assembly, including the necessary connectors, comprised of all components, subsystems, or both, between the anchorage or anchorage connector and the harness attachment point.

Connector - A component or element that is used to couple parts of the system together.

Deceleration Distance - The vertical distance between the user's fall arrest attachment at the onset of fall arrest forces during a fall, and after the fall arrest attachment comes to a complete stop.

Energy (Shock) Absorber - A component whose primary function is to dissipate energy and limit deceleration forces which the system imposes on the body during fall arrest.

Fall Arrest - The action or event of stopping a free fall or the instant where the downward free fall has been stopped.

Fall Hazard - Any location where a person is exposed to a potential free fall.

Free Fall - The act of falling before a fall protection system begins to apply forces to arrest the fall.

Free Fall Distance - The vertical distance traveled during a fall, measured from the onset of a fall from a walking working surface to the point at which the fall protection system begins to arrest the fall.

Harness, Full Body - A body support designed to contain the torso and distribute the fall arrest forces over at least the upper thighs, pelvis, chest and shoulders.

Horizontal Lifeline - A component of a horizontal lifeline subsystem, consisting of a flexible line with connectors or other coupling means at both ends for securing it horizontally between two anchorages or anchorage connectors.

Horizontal Lifeline Subsystem - An assembly, including the necessary connectors, comprised of a horizontal lifeline component and, optionally, of:
a) An energy absorbing component or, b) A lifeline tensioner component, or both. This subsystem is normally attached at each end to an anchorage or anchorage connector. The end anchorages have the same elevation.

Horizontal Lifeline – A component of a horizontal lifeline subsystem, consisting of a flexible line with connectors or other coupling means at both ends for securing it horizontally between two anchorages or anchorage connectors.

Horizontal Lifeline Subsystem – An assembly, including the necessary connectors, comprised of a horizontal lifeline component and, optionally, of:
a) An energy absorbing component or, b) A lifeline tensioner component, or both. This subsystem is normally attached at each end to an anchorage or anchorage connector. The end anchorages have the same elevation.

Lanyard - A component consisting of a flexible rope, wire rope or strap, which typically has a connector at each end for connecting to the body support and to a fall arrester, energy absorber, anchorage connector or anchorage.

Lanyard Connecting Subsystem - An assembly, including the necessary connectors, comprised of a lanyard only, or a lanyard and energy absorber.

Personal Fall Arrest System (PFAS) - An assembly of components and subsystems used to arrest a person in a free fall.

Positioning - The act of supporting the body with a positioning system for the purpose of working with hands free.

Positioning Lanyard - A lanyard used to transfer forces from a body support to an anchorage or anchorage connector in a positioning system.

Qualified Person - A person with a recognized degree or professional certificate and with extensive knowledge, training and experience in the fall protection and rescue field who is capable of designing, analyzing, evaluating and specifying fall protection and rescue systems.

Self-Retracting Device (SRD) - A device that contains a drum wound line that automatically locks at the onset of a fall to arrest the user, but that pays out from and automatically retracts onto the drum during normal movement of the person to whom the line is attached.

Snaphook - A connector comprised of a hook-shaped body with a normally closed gate or similar arrangement that may be opened to permit the hook to receive an object and, when released, automatically closes to retain the object.

Swing Fall - A pendulum-like motion that occurs during and/or after a vertical fall. A swing fall results when an authorized person begins a fall from a position that is located horizontally away from a fixed anchorage.

Appendix A







| Table 1A: Specifications for Post Anchors | | | |
|---|--|--|---|
| Part Numbers | Minimum Tensile Strength and Material | Maximum User Capacity | Image |
| 78012CSSD 12" Post Anchor, Swivel D-Ring, 12" x 12" Base Concrete/Steel | 60,000 in-lb (6,779 N m) Min Moment and 5,000 lbf (2,268 kg) Min Vertical Load Hot Dipped Galvanized Plated Carbon Steel | 310 lbs. including clothing, tools, etc. to comply with ANSI Z359 and OSHA |  |
| 78012CSSC 12" Post Anchor, SRL Cradle, 12" x 12" Base Concrete/Steel | | |  |
| 78012CSWE 12" Post Anchor, Welded Eye, 12" x 12" Base Concrete/Steel | | |  |
| 78012CSTH 12" Post Anchor, 5/8"-11 Threaded Hole, 12" x 12" Base Concrete/Steel | | |  |
| 78012WCSSD 12" Post Anchor, Swivel D-Ring, 16" x 16" Base Concrete/Steel/Wood | | |  |
| 78012WCSSC 12" Post Anchor, SRL Cradle, 16" x 16" Base Concrete/Steel/Wood | | |  |
| 78012WCSWE 12" Post Anchor, Welded Eye, 16" x 16" Base Concrete/Steel/Wood | | |  |
| 78012WCSTH 12" Post Anchor, 5/8"-11 Threaded Hole, 16" x 16" Base Concrete/Steel/Wood | | |  |
| 78012PTH 12" Post Anchor, 5/8"-11 Threaded Hole, Weld-On Base | | |  |
| 78012PWE 12" Post Anchor, Welded Eye, Weld-On Base | | |  |

Table 1A: Specifications for Post Anchors (Continued)

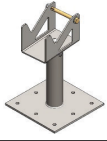
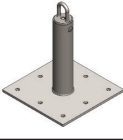
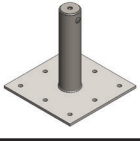
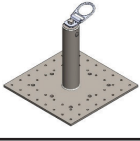
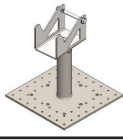
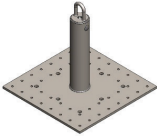
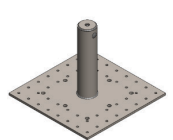
| Part Numbers | Minimum Tensile Strength and Material | Maximum User Capacity | Image | |
|---|---|--|---|---|
| 78218CSSD 18" Post Anchor, Swivel D-Ring, 12" x 12" Base Concrete/Steel | 90,000 in-lb (10,169 N m) Min Moment and 5,000 lbf (2,268 kg) Min Vertical Load Hot Dipped Galvanized Plated Carbon Steel | 310 lbs. including clothing, tools, etc. to comply with ANSI Z359 and OSHA |  | |
| 78218CSSC 18" Post Anchor, SRL Cradle, 12" x 12" Base Concrete/Steel | | |  | |
| 78218CSWE 18" Post Anchor, Welded Eye, 12" x 12" Base Concrete/Steel | | |  | |
| 78218CSTH 18" Post Anchor, 5/8"-11 Threaded Hole, 12" x 12" Base Concrete/Steel | | |  | |
| 78218WCSSD 18" Post Anchor, Swivel D-Ring, 16" x 16" Base Concrete/Steel/Wood | | | 425 lbs. including clothing, tools, etc. to comply with OSHA only |  |
| 78218WCSSC 18" Post Anchor, SRL Cradle, 16" x 16" Base Concrete/Steel/Wood | | | |  |
| 78218WCSWE 18" Post Anchor, Welded Eye, 16" x 16" Base Concrete/Steel/Wood | | | |  |
| 78218WCSTH 18" Post Anchor, 5/8"-11 Threaded Hole, 16" x 16" Base Concrete/Steel/Wood | | | |  |
| 78218PTH 18" Post Anchor, 5/8"-11 Threaded Hole, Weld-On Base | | | |  |
| 78218PWE 18" Post Anchor, Welded Eye, Weld-On Base | | | |  |

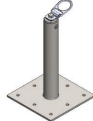
| Table 1A: Specifications for Post Anchors (Continued) | | | |
|---|--|---|---|
| Part Numbers | Minimum Tensile Strength and Material | Maximum User Capacity | Image |
| 78312P 12" x 12" Plate | 90,000 in-lb (10,169 N m) Min Moment and 5,000 lbf (2,268 kg) Min Vertical Load Hot Dipped Galvanized Plated Carbon Steel | 310 lbs. including clothing, tools, etc. to comply with ANSI Z359 and OSHA 425 lbs. including clothing, tools, etc. to comply with OSHA only |  |
| 78316P 16" x 16" Plate | | |  |
| 7840SC SRL Cradle for Post Anchor | 5,000 lbs Min Zinc Plated Steel | |  |
| 7840SD Swivel D-Ring for Post Anchor | | |  |

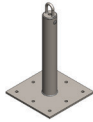
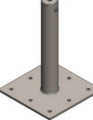
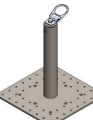
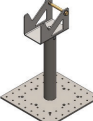
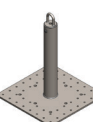
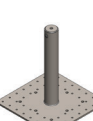
| Table 1B: Post Anchor Compliance Chart | | | |
|--|---------------|-------------------|---------------|
| Part Numbers | Application | ANSI Z359.18-2017 | OSHA 1926.502 |
| 78012CSSD 78012CSSC 78012CSWE 78012CSTH | Concrete | ✓ | ✓ |
| | Steel | ✓ | ✓ |
| 78012WCSSD 78012WCSSC 78012WCSWE 78012WCSTH | Concrete | ✓ | ✓ |
| | Steel | ✓ | ✓ |
| | Wood | | ✓ |
| 78011PTH 78011PWE | Steel Weld-On | ✓ | ✓ |
| 78218CSSD 78218CSSC 78218CSWE 78218CSTH | Concrete | ✓ | ✓ |
| | Steel | ✓ | ✓ |
| 78218WCSSD 78218WCSSC 78218WCSWE 78218CSTH | Concrete | ✓ | ✓ |
| | Steel | ✓ | ✓ |
| | Wood | | ✓ |
| 78218PTH 78218PWE | Steel Weld-On | ✓ | ✓ |

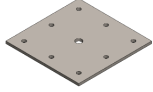
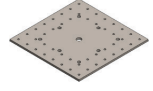
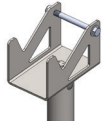
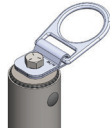