

ALLOWS FOR EASY PORTABILITY OF VOLLEYBALL UPRIGHTS. COMPACT STEEL CUP, TRANSPORTS ONE UPRIGHT AT A TIME TO AND FROM STORAGE

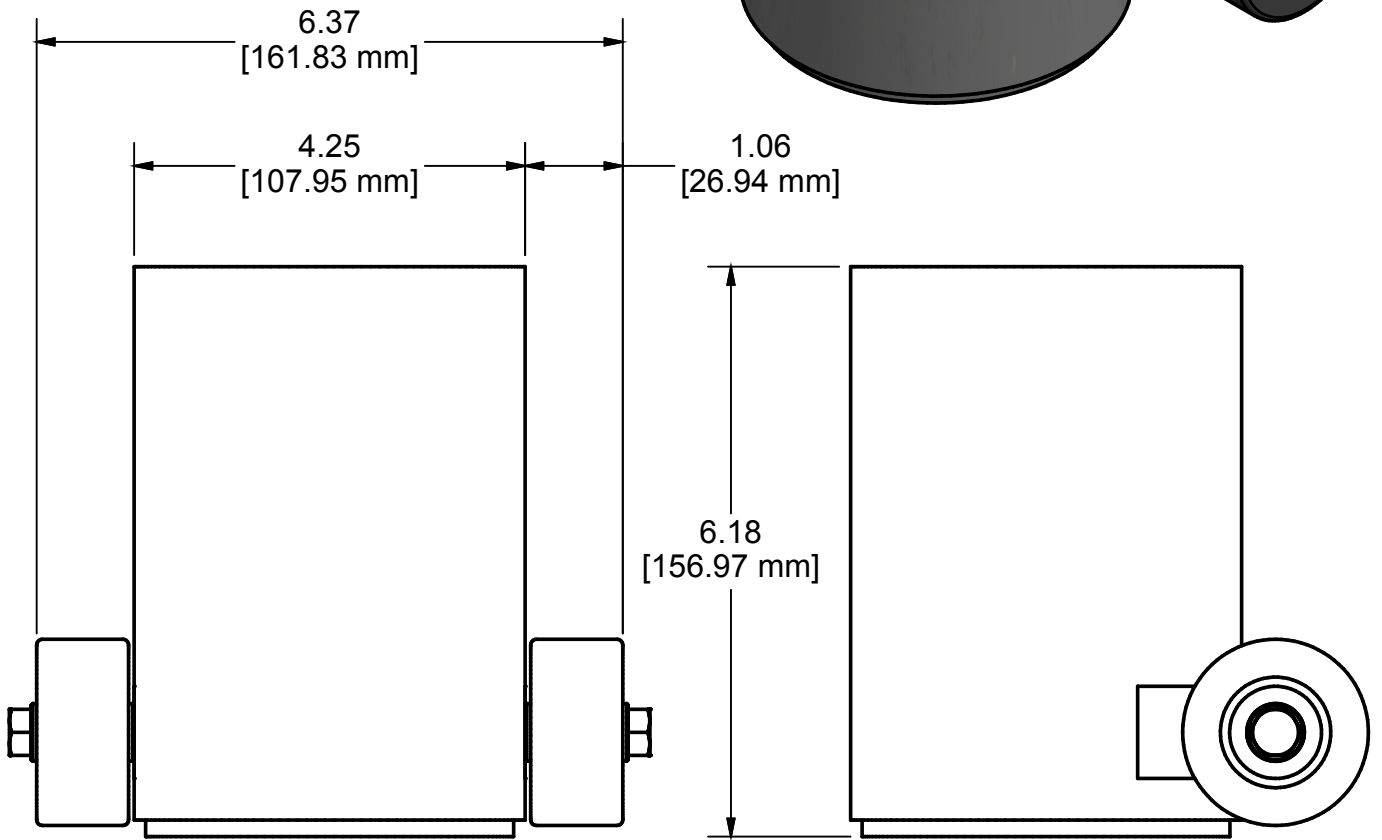

REV	BY	DATE

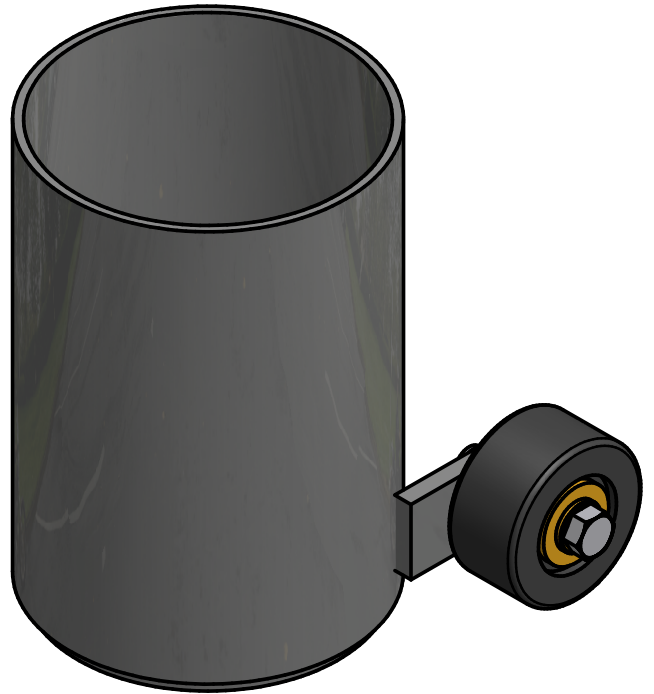

Gared Holdings, LLC
9200 E. 146th St. Noblesville, IN 46060

THIS DOCUMENT CONTAINS TRADE SECRET AND OTHER MATERIALS WHICH ARE PROTECTED BY CONFIDENTIALITY NOTICE AND AGREEMENT AND BY COPYRIGHT. ANY USE OR COPYING OF THIS DOCUMENT EXCEPT AS AUTHORIZED BY GARED HOLDINGS, LLC IS STRICTLY PROHIBITED.

4" VOLLEYBALL UPRIGHT TRANSPORTER

DRAWN	DKH	DATE	6/3/2009	DATE ISSUED	6/10/2009
APPROVED	DWP	DATE	6/10/2009		
FILE LOC: Q:\Inventor Files\Specifications\11_volleyball\6293					
SIZE	SCALE	SHT. NO.	PART NO.	REV	
A	NONE	1 OF 1	6293		