

**ASSEMBLY INSTRUCTIONS
for the BLANKET HANDLER (FG-BH)
& WHEELS REEL (FG-1B) REEL SYSTEMS**

PLEASE READ ENTIRE INSTRUCTIONS CAREFULLY BEFORE PROCEEDING

Four Easy Steps:

If you need additional assistance, contact us at info@feherguard.com or call 905-876-4766 Monday to Friday 8:30 a.m. to 5:00 p.m. Eastern Time.

Before starting assembly, trim cover to clear the inside top edge of your pool to eliminate drag when rolling up cover.
Recommended Solar Cover is 12 mil with round bubbles.
Allow an extra 4" (10 cm) on cover length if installing the reel at mid-point or off-center.

REEL SYSTEMS COMPONENTS AND PREPARATION:

Getting started:

Ensure that your system has two cartons consisting of one end carton and one tube set carton.

Tools required for assembly: Recommend Safety Glasses

- Portable drill
- Tape measure
- Pencil and Scissors

Tube Carton Parts List:
2 end tubes and 1 center tube

FG1B Parts List:
2 Wheels 2 Wheel Stops
2 Handles 2 Bearings
2 Plugs for 3" diameter tubes

Hardware Kit: 20 Strap Plates
10 Straps 10 Plastic Screws
25 Self-drilling Metal Screws

FG-BH Parts List: (FG-BH)
2 End Brackets 4 Casters
2 Handles 2 Bearings
2 Plugs for 3" diameter tubes

Hardware Kit: 20 Strap Plates
10 Straps 10 Plastic Screws
25 Self-drilling Metal Screws

STEP 1: SOLAR REEL PLACEMENT:

- A. Determine the best location for the reel system. *The widest point of the pool is the preferred locations (see Fig. 1 below). Small cover extensions may be folded in to avoid using a wider reel.*
- B. At the determined location, measure the width of the pool and add 6" (15 cm).

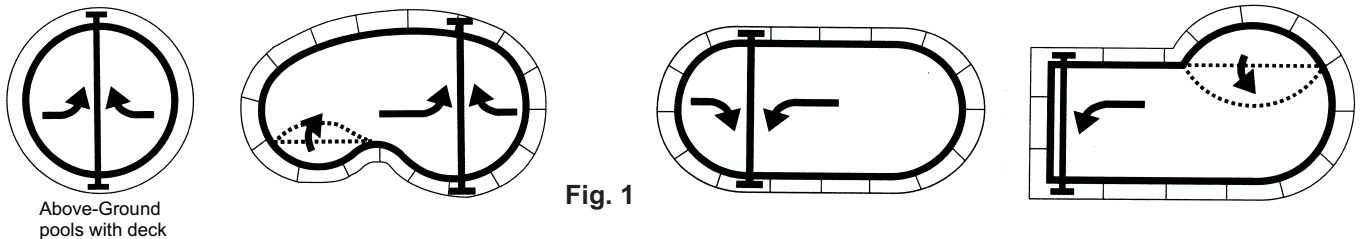

STEP 2: TUBE ASSEMBLY

Configuration for L16M*, L18, L18M*, IG20, L20M* and LC25 Tube Sets

- A. Ensure minimum of each end tube is inside center tube (see table below right).
Less than minimum insert causes screws to loosen and/or tubes to split.



Fig. 2a Insert both end tubes equal distance into center tube and mark on center tube where inner tubes end

Tube	Min. Insert	Max. Width	Max. Wet Cover Weight	Max. Cover
L16M*	9"	16'6" (5.03m)	60# (27.3kg)	16x32
L18/L18M*	9"	18'6" (5.7 m)	60# (27.3kg)	18x36
IG20	12"	20'6" (6.3 m)	60# (27.3kg)	20x40
L20M*	12"	20'6" (6.3 m)	60# (27.3kg)	20x40
LC25	24"	25' (7.6m)	75# (36kg)	25x50

* Mill tubes tarnish over time. Anodized tubes help reduce tarnishing.

STEP 2: TUBE ASSEMBLY - CONTINUED

THIS STEP REQUIRES A TOTAL OF 12 SELF-DRILLING SCREWS **DO NOT** pre-drill holes or over-tighten screws.

- B. Lock tubes together by rotating the center tube in the opposite direction to end tube. **HOLD TUBES LOCKED WHILE YOU INSTALL FIRST SELF-DRILLING SCREW ON A DRILL LINE, 1" (2.5 cm) back from end of center tube at Location "C1"** (see Fig. 3 & 4).
- C. Place 2 more self-drilling screws at Location "C2" & "C3" - 1 screw at every second drill line around tubes (see Fig. 3).
- D. At "D" locations install 3 screws around the center tube at every second drill line, 1" (2.5 cm) back from where you marked the end of the inner tube from Fig. 2A (see also Fig. 3).
- E. Repeat for other end tube.

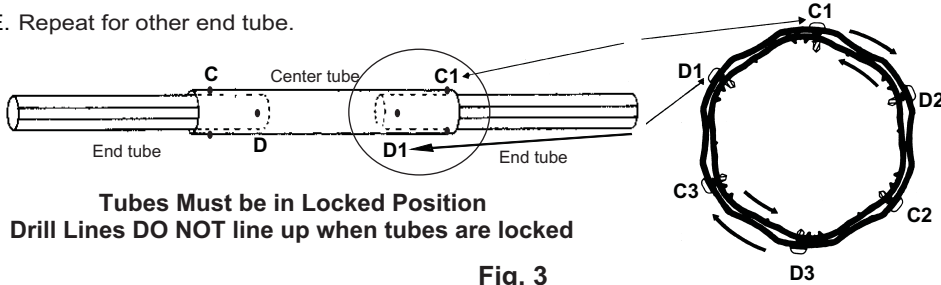

Fig. 3

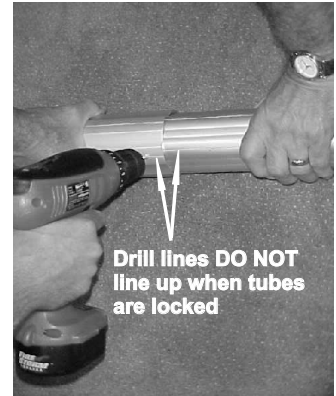

Fig. 4

**Tubes Must be in Locked Position
Drill Lines DO NOT line up when tubes are locked**

STEP 3: ASSEMBLE ENDS

Assemble in numerical order (see Fig. 5 or 6):

- Insert Plug (#1) into End Tube. (Use the 2 plugs with appropriate diameter for your tube. You can discard the other set)
- Place Bearing (#2) inside End Bracket or Wheel (#3).
- Push Handle (#4) through Bearing and into Plug.
- Insert 1 self-drilling screw (#5) through tube in line with bump on plug rim and 1" (2.5 cm) from tube end. (see Fig. 7).
- Repeat for other end.

5. Insert Screw 1" (2.5 cm) from tube end (See Fig. 7)

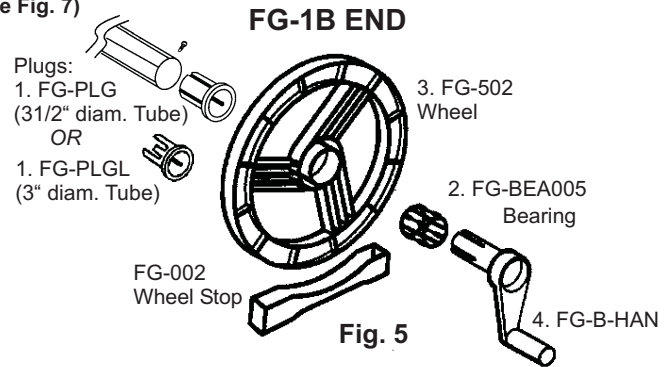

Fig. 5

Plugs:
1. FG-PLG (3 1/2" diam. Tube)
OR
1. FG-PLGL (3" diam. Tube)

FG-BH PLACE LONG SIDE OF TRIANGLE TOWARD LONGEST SECTION OF COVER.

5. Insert Screw 1" (2.5 cm) from tube end (See Fig. 7)

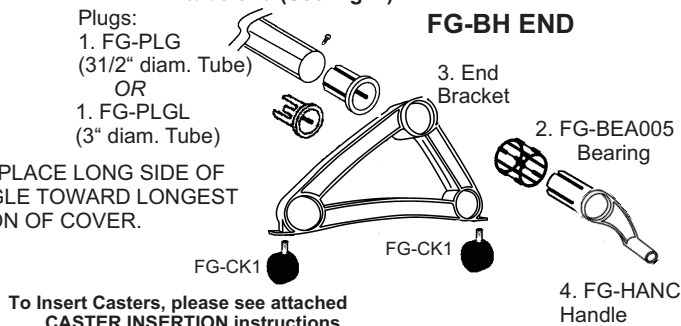

Fig. 6

IMPORTANT:
5. When ends are assembled insert screw through tube in line with bump on plug rim, 1" (2.5 cm) from tube end - at BOTH ends.



Fig. 7

STEP 4: STRAP ATTACHMENT

Attach a Strap Plate to EACH end of all Straps provided (see Fig. 8).

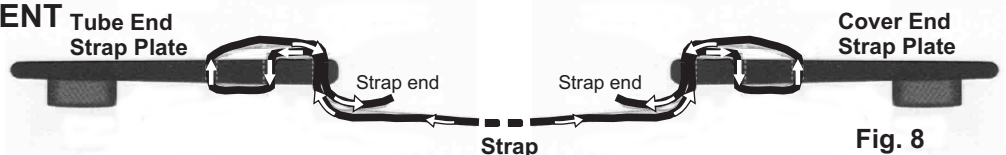
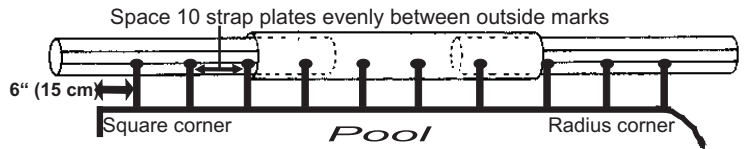
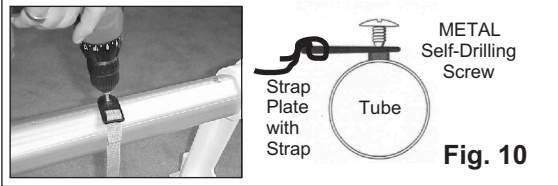

Fig. 8

STRAP ATTACHMENT - TO TUBE

- A. Mark strap plate location on tube drill lines. First strap plate is placed 6" (15 cm) in from inside edge of pool or at the start of the radius corner (see Fig. 9).
- B. Attach strap plates to the tube with metal screws (see Fig. 10). **DO NOT pre-drill holes or over-tighten screw.** Use all straps provided.



Space 10 strap plates evenly between outside marks
 6" (15 cm) → Square corner Pool Radius corner
 First strap plate is placed 6" (15 cm) in from inside edge of pool or at start of radius corner. Place system across widest point of pool if radius corners are greater than 6".

Fig. 9

STRAP ATTACHMENT - TO COVER

- C. Choose either Fig. 11 OR Fig. 12 - the appropriate instructions below for your pool shape. If you have determined a mid-pool or off-center placement, it will be easier if you move the cover away from the pool and fold it (bubbles in) on a flat surface.

For Systems Placed at Pool End (Rectangular Pools) (Fig.11)

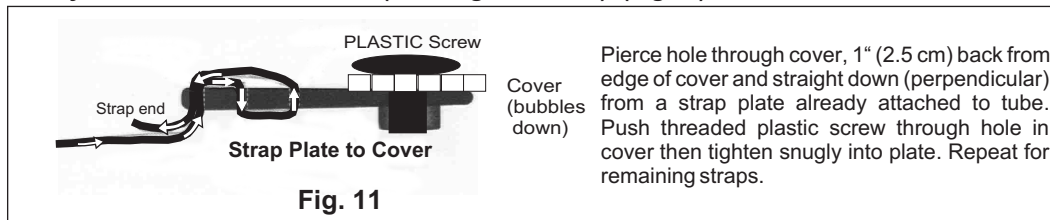

Pierce hole through cover, 1" (2.5 cm) back from edge of cover and straight down (perpendicular) from a strap plate already attached to tube. Push threaded plastic screw through hole in cover then tighten snugly into plate. Repeat for remaining straps.



For Systems placed at Mid-Pool or Off Center (Round, Oval or Irregularly Shaped Pools) (Fig. 12)

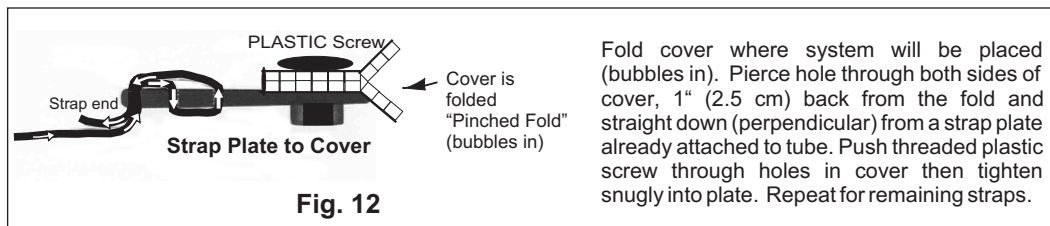

Fold cover where system will be placed (bubbles in). Pierce hole through both sides of cover, 1" (2.5 cm) back from the fold and straight down (perpendicular) from a strap plate already attached to tube. Push threaded plastic screw through holes in cover then tighten snugly into plate. Repeat for remaining straps.



- D. When you start to roll up the cover, all straps must take hold of the cover at the same time. Adjust the strap lengths if necessary.

Safe Use of Your Solar Reel:

Solar Reel systems are designed solely to remove solar covers and are not made to support people or any other weight.

Solar covers must be completely removed before entry into the pool. Under no circumstances, should one swim in a pool partially covered with the solar cover.

Care and Storage:

Check screws periodically and tighten, if necessary. The solar reel may be stored outside for the winter. It is not recommended to disassemble it for storage inside.

In order to protect the warranty on your solar cover, it is essential to use a protective cover when the it is rolled up on the reel. In the summer use a White Sheet with UV inhibitors and in Winter, a Winter Jacket.

If not provided, they can be purchased from your pool retailer or by completing the enclosed order form.





Five Year Warranty:

FeherGuard warrants for a period of five years from the date of delivery to the original consumer purchaser, that the Blanket Handler or the Wheels Reel Solar Cover Reel System shall be free from defects in workmanship or material, under normal use and in accordance with FeherGuard's written installation and use instructions. FeherGuard at its option shall supply free of charge any part found to be defective in workmanship or material.

Any implied warranties are limited in duration to the five-year period from the date of delivery to the original consumer purchaser. **Excluded from this warranty are all consumables (bearings, straps, strap plates, screws). Tarnishing or discoloration of mill aluminum tubes can occur. This is not a warranty issue as tarnishing does not affect tube performance or integrity.**

This Warranty is void if there is evidence of purchaser abuse, improper installation or normal wear.

FeherGuard will not be liable for incidental or consequential damages resulting from any defects in workmanship or material. Some States/Provinces/Countries do not allow the exclusion or limitation of incidental or consequential damages, so the foregoing limitations or exclusions may not apply.

This Warranty gives the claimant specific legal rights. The provisions of this Warranty are in addition to and not a modification of or a subtraction from the statutory warranties and other rights and remedies contained in applicable local legislation.

To validate Warranty, return this registration form within 30 days of purchase.
You may also register your warranty online on our Home Page at www.feherguard.com.

FeherGuard Products Ltd. 3153 Steeles Avenue West #5
Milton, Ontario CANADA
L9T 2V4

Specifications subject to change without notice.

08/12

**Thank you for buying the Blanket Handler or the Wheels Reel Solar Cover Reel System.
We know it will make solar cover handling easy for you.**



FeherGuard "Five Year" Warranty Registration

Please Print

PURCHASER: _____

ADDRESS: _____ CITY: _____

STATE/PROVINCE/COUNTRY: _____ ZIP/POSTAL CODE: _____

FG1B or FG-BH _____
(circle one) MODEL # STORE LOCATION PURCHASE DATE