



Spaside Remote Control

for Aqua Logic and Pro Logic

Owner's Manual



Contents

Compatibility.....	1
Installation.....	1
Operation.....	7
Troubleshooting.....	9
Warranty.....	14

AQL-SS-6B
AQL-SS-D

Hayward Pool Products
620 Division Street, Elizabeth NJ 07207
Phone: (908) 355-7995
www.hayward.com



Compatibility

Pro Logic

The AQL-SS-6B-x is compatible with all Pro Logic P-4 and PS versions. The AQL-SS-6B can control 6 separate functions. The remote is configurable, allowing the user to assign buttons to specific functions within the Configuration Menu.

The AQL-SS-D is compatible with all Pro Logic PS versions only. The AQL-SS-D can control 8 functions and provides spa and air temperature via the backlit LCD display. In addition to viewing temperatures, you can also set the spa heater temperature with the AQL-SS-D remote control.

Aqua Logic

The AQL-SS-6B-x and AQL-SS-D-x (where the x denotes the color; W=white, G=gray, B=black) are compatible with all PS Aqua Logic controls that use software version 2.40 or later (refer to the Aqua Logic manual to determine software version). The AQL-SS-6B is also configurable when used with the Aqua Logic P-4 running software version 2.40 or later. The AQL-SS-6B is compatible with PS and P4 models prior to version 2.40, but is not configurable (the buttons are fixed to operate specific functions).

For PS systems with software version 2.40 or later:

Both units allow the user to assign buttons to specific functions. The AQL-SS-6B can control 6 separate functions. The AQL-SS-D can control 8 functions and provides spa and air temperature via the backlit LCD display. In addition to viewing temperatures, you can also set the spa heater temperature with the AQL-SS-D remote control. Both models are configured through the configuration menu in the Aqua Logic.

For P4 systems with software version 2.40 or later:

The AQL-SS-6B can control 6 separate functions. The remote is configurable, allowing the user to assign buttons to specific functions within the Configuration Menu. The AQL-SS-D is not compatible with these systems.

For PS and P4 systems with software prior to version 2.40:

Only the AQL-SS-6B can be used with these systems and is preconfigured to operate specific functions. The buttons can not be assigned. The diagram below shows the button functions and locations for the AQL-SS-6B when used with Aqua Logic models running software prior to version 2.40. The AQL-SS-D is not compatible with these systems.

Installation

The AQL-SS-6B and AQL-SS-D are double insulated, waterproof devices that are designed for installation at the water's edge. The remote controls are typically installed at the tile-line of the spa wall, or in the deck, within arm's reach of a spa occupant. Before the pool/spa construction is complete, run electrical conduit from the desired remote location back to the Pro Logic or Aqua Logic. The installation of the remote should be AFTER the pool/spa construction is complete. For new tile and concrete applications, optional Mud Boxes (Goldline part AQL-SS-6B-BOX and AQL-

SS-D-BOX) are available for both remotes to aid in installation. For mud box installation, refer to the instructions included with the boxes. For all other installations, refer to the information on the following pages.

Surface Mount Installation (without Mud Box)

1. The AQL-SS-6B/D's unique design allows you to use 1½", 1¼", or 1" diameter Schedule 40 PVC for installation. Install a 6" (minimum) piece of PVC pipe in the pool/spa wall at a location above the high water mark. There must be at least 2" of clearance from coping stones or other raised objects to the Schedule 40 pipe. It is advisable that this pipe be plumbed as level as possible although the O-ring is designed to compensate for small variations from perpendicular if necessary.
2. The pipe should protrude beyond the finished surface of the spa, as it will be cut back after surface finishing is completed. Reduce the pipe to ½" or ¾" electrical conduit and run back to the Pro Logic/Aqua Logic, using sweep elbows for any turns in the run.
3. Depending on the PVC pipe size used, mount the appropriate size O-ring on the back of the remote control as shown below and cut the other two off of the cable.

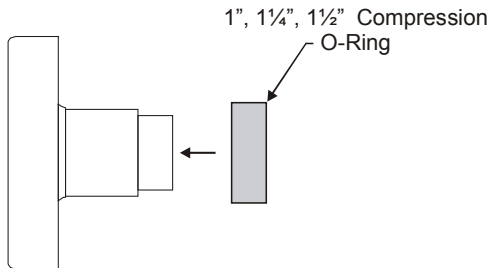

4. When the spa construction is completed, cut back the PVC conduit receptacle flush with the spa wall or surface of the deck. Run the cable from the AQL-SS-6B/D through the conduit to the Pro Logic or Aqua Logic.
5. Run a small bead of silicone sealant along outside edge of the remote control. Attach remote to the mounting surface by sliding the O-ring into pipe and pushing against the surface.
NOTE: Do NOT apply sealant to compression O-ring or PVC pipe. See below.

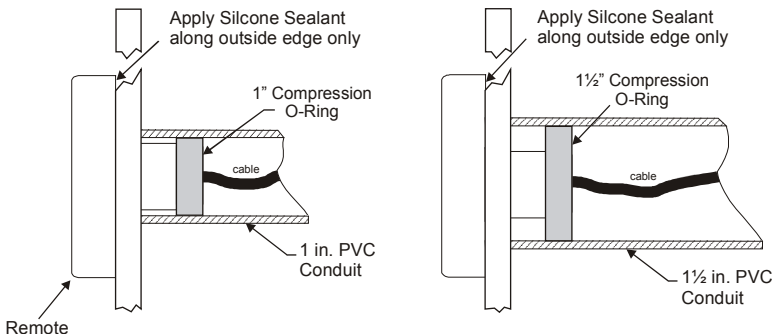

Flush Mount Installation (without optional Mud Box)

Flush mounting the AQL-SS-6B/D is similar to surface mounting except that the flush mount frame is used and a cutout is made to accommodate the body. The remote (with frame) is inserted into the cutout and the O-ring is inserted into the PVC pipe. Refer to the diagram below and follow the following steps:

1. Find the desired location for the installation of the AQL-SS-6B/D and cut out the hole using one of the included templates (page 10). The remote should be mounted in a location above the high water mark.
2. Install a 6" (minimum) piece of 1", 1¼", or 1½" PVC pipe to be used as a receptacle for the AQL-SS-6B/D. The pipe will be installed in the pool/spa wall, centered on the cutout with the pipe end located ¾" behind the cutout surface. The other end should be attached to ½" or ¾" electrical conduit and run back to the Pro Logic/Aqua Logic. See below. It is advisable that this pipe be plumbed as level as possible although the O-ring is designed to compensate for small variations from perpendicular if necessary.
3. Run the cable from the AQL-SS-6B/D through the conduit to the Pro Logic/Aqua Logic.
4. Run a small bead of silicone sealant along the outside edge of the frame. Attach the remote to the mounting surface by sliding the O-ring into the pipe and pushing the frame against the surface. **NOTE: Do NOT apply sealant to the compression O-ring or PVC pipe.**

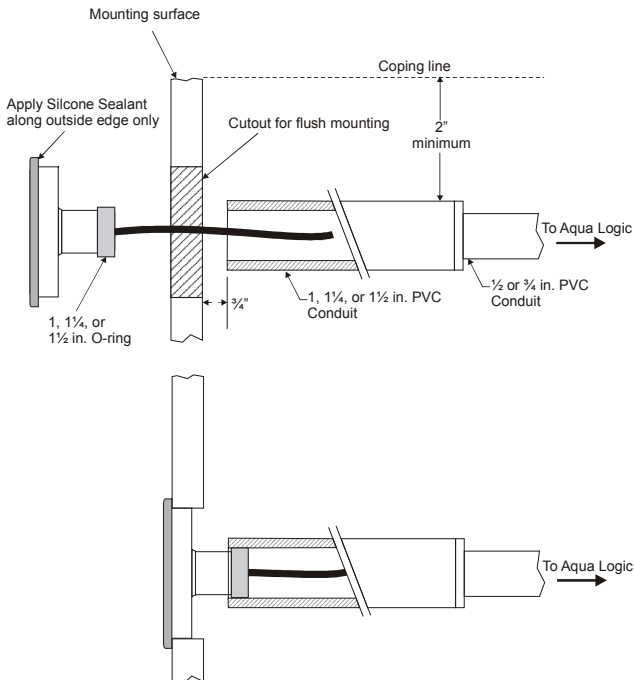



Flush Mount Installation using optional Mud Box

Refer to instructions that are included with the AQL-SS-6B-BOX or AQL-SS-D-BOX Mud Box. Cutout templates are provided on page 10.

Wiring

The AQL-SS-6B/D comes with 150 ft. of 5-conductor 24 AWG outdoor rated cable. In most applications, the cable will need to be shortened. Follow the wiring instructions below:

1. Turn off AC power to the Pro Logic or Aqua Logic
2. Run the cable through the conduit from the remote mounting location to the Pro Logic/Aqua Logic.
3. Route the cable through one of the knockouts on the left side of the Pro Logic/Aqua Logic. If the cable needs to be shortened, cut the cable to length.
4. Strip back the gray jacket and strip each of the 5 conductors to expose 1/8" bare wire.
5. Connect wires to the 4 position terminal block located on the upper left corner of the printed circuit board. Refer to the "Wiring Configurations" section and follow the wiring diagram below. Note that the White wire is connected to the screw terminal labeled "Yellow".
6. Turn on power to the Pro Logic/Aqua Logic.

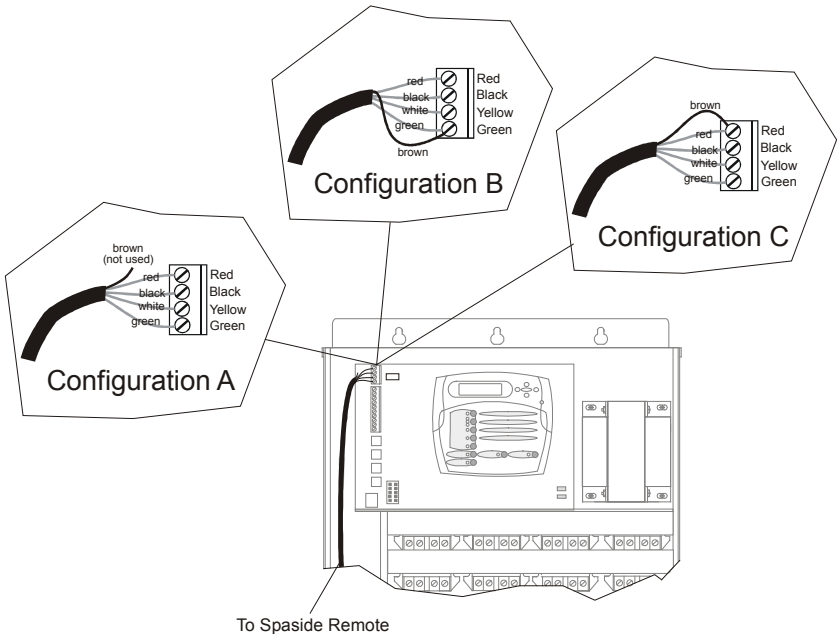



Wiring Configurations

Up to 3 wired remote controls of any type can be connected to the Pro Logic or Aqua Logic. The AQL-SS-6B and AQL-SS-D are wired to the Pro Logic/Aqua Logic in one of 3 ways, depending on how many wired spa side controls will be used. Refer to diagram on page 4. For a single remote control, use "Configuration A" wiring instructions. For two remote controls of the same type, use "Configuration A" on one remote, and "Configuration B" on the other. If not the same type, use "Configuration A" for both. For 3 remote controls of the same type, use "Configuration A" on one remote, "Configuration B" on another, and "Configuration C" on the last. If not the same type, use "Configuration A" for one remote type, and use "Configuration A" and "Configuration B" for the other type. All remotes are connected to the same terminal block.





The connection of the brown conductor will determine the configuration. The other 4 conductors will always connect to their corresponding screw terminals (White wire goes to "Yellow" labeled screw terminal) on the Pro Logic/Aqua Logic terminal block.

Configuration

For all Pro Logic systems and Aqua Logic systems with software version 2.40 or later, it is necessary to configure the Aqua Logic to operate with the AQL-SS-6B or AQL-SS-D. Note that the AQL-SS-D cannot be used with any P-4 models. For Aqua Logic systems with software version less than 2.40, only the AQL-SS-6B can be used and no configuration is possible. Follow the information below.

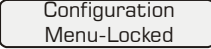
For Pro Logic and Aqua Logic PS and P4 systems with software version 2.40 or greater:

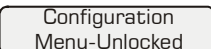
Access the Configuration Menu







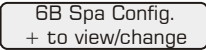

-   Press repeatedly until "Configuration Menu" is displayed
-  Press BOTH buttons SIMULTANEOUSLY for 5 seconds to unlock
-   Move to configuration menu items

NOTE: The configuration menu automatically "locks" after 2 minutes of no buttons being pressed to prevent unauthorized people from changing the control logic inadvertently and possibly damaging the pool equipment or causing a "call back" to fix the configuration.

Scroll to "6B Spa Config." or "Digital Spa Config." depending on your model.

If using AQL-SS-6B:

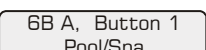
if AQL-SS-6B is connected

-   Push to access the 6 Button Spa Side Remote options
-  Move to previous/next configuration menu item
-   Rotates between all available remotes
-  Move to next menu item
-   Rotates between System Off, Pool/Spa, Filter, Lights, Heater1, Valve3, Valve4, and all available Aux outputs
-  Move to previous/next configuration menu item

Select 6B Spa













This menu only appears if more than one AQL-SS-6B is detected at power up. Select which of the available remote controls (A, B or C) is to be configured.

6B A, Button 1

This menu allows the user to map each button of the AQL-SS-6B to one of the standard Pro Logic/Aqua Logic functions. The default selections are: Button 1 - Pool/Spa, Button 2 - Filter, Button 3 - Lights, Button 4 - Heater1, Button 5 - Aux1 and Button 6 - Aux2.

If using AQL-SS-D:

if AQL-SS-D is connected

Digital Spa Config. + to view/change	 Push to access the Digital Spa Side Remote options   Move to previous/next configuration menu item
Select Digital Spa A	 Rotates between all available remotes   Move to next menu item
Digital A, Button 1 Pool/Spa	 Rotates between System Off, Pool/Spa, Filter, Lights, Heater1, Valve3, Valve4, and all available Aux outputs   Move to previous/next configuration menu item
Digital A, Setpoint Heater1	 Rotates between heaters that are enabled   Move to previous/next configuration menu item

Select Digital Spa

This menu only appears if more than one AQL-SS-D is detected at power up. Select which of the available remote controls (A, B or C) is to be configured.

Digital A, Button 1

This menu allows the user to map each button of the AQL-SS-D to one of the standard Pro Logic/Aqua Logic functions. The default selections are: Button 1 - Pool/Spa, Button 2 - Filter, Button 3 - Lights, Button 4 - Heater1, Button 5 - Valve3, Button 6 - Valve4, Button 7 - Aux1 and Button 8 - Aux2.

Digital A, Setpoint

This menu only appears if at least one of the two heaters (Heater1 and/or Heater2) are enabled. If both heaters are enabled, select the spa heater you wish to control. If only one heater is installed, Heater1 is the default.



Operation

Operation of both remotes is straightforward. Pushbuttons are used to access the options for each function and LED lights indicate the status of that function. The AQL-SS-D has a digital display which is used to set and view temperatures.

Use the label sheets supplied with your remote control to properly label each function. Both remotes contain backlit “windows” which allow the labels to be seen clearly, day or night. Remove the desired label and adhere it to proper window. Refer below for specific operation information.

AQL-SS-6B

When connected to units running software version 2.40 or greater, the AQL-SS-6B's six pushbuttons can be assigned to operate various functions. With older version software, the AQL-SS-6B will control fixed functions (see page 1).

Backlights behind the function labels allow the user to clearly see which output is being controlled during the day or night. LED lights next to the labels will indicate the status of the function.

The operation of functions that are controlled by the AQL-SS-6B will vary. On/Off functions like “Lights” and “Aux's” operate in the same manner. Other functions like “Heater” and “Pool/Spa” operate differently. Operation information for each function is shown below.

If “Pool and Spa - Std” (shared equipment for pool & spa)

Pool/Spa: Pressing the “Pool/Spa” button will alternate between Pool Only and Spa Only. If Spillover is enabled, the button will alternate operation between Pool Only, Spa Only and Spillover. The LED will only light when in the Spa Only mode.

Filter: When the “Filter” button is pressed, the pool filter pump will turn on or off, depending on its previous condition. The LED will turn on when the pump is on. If a 2-speed pump is used, the button will cycle the pump from Hi-speed to Lo-speed to Off. In this case, the LED will blink when in Lo-speed and be on steady when in Hi-speed. The LED will also blink while in “Cooldown” mode.

Lights & all Aux's: When the “Lights” or “Aux” buttons are pressed, the feature that is connected to the corresponding Pro Logic/Aqua Logic relay will turn on or off, depending on its previous condition. The LED will light when the function is on.

Heater: When the “Heater” button is pressed, the Pro Logic/Aqua Logic will turn the heater on for 5 minutes, regardless of the heater temperature setting. After 5 minutes, the heater will continue to run if the water temperature is less than the heater temperature setting. When the heater turns off, the Pro Logic/Aqua Logic's heater control will be in an automatic state. Pushing the heater button anytime while the heater is on, will shut the heater off and put the Pro Logic/Aqua Logic's heater control in a manual off state.

NOTE: The LED indicator will illuminate whenever the heater is running. Also, the Pro Logic/Aqua Logic will never allow the water temperature to exceed 104°F (40°C).



If “Pool and Spa - Dual” (separate equipment for pool & spa)

Pool Only/Spillover: Pressing the “Pool/Spa” button will alternate between Pool Only and Spillover mode (if enabled). Spillover only works when the Spa filter pump is off. The LED will not be lit.

Filter: When the “Filter” button is pressed, the pool filter pump will turn on or off, depending on its previous condition. The LED will turn on when the pump is on. If a 2-speed pump is used, the button will cycle the pump from Hi-speed to Lo-speed to Off. In this case, the LED will blink when in Lo-speed and be on steady when in Hi-speed. The LED will also blink while in “Cooldown” mode.

Lights & all Aux's except Aux 1: When the “Lights” or “Aux” buttons are pressed, the feature that is connected to the corresponding Pro Logic/Aqua Logic relay will turn on or off, depending on its previous condition. See information below for Aux 1 operation. The LED will light when the function is on.

Spa Heater: When the “Heater” button is pressed, the Pro Logic/Aqua Logic will turn the heater on for 5 minutes, regardless of the heater temperature setting. After 5 minutes, the heater will continue to run if the pool water temperature is less than the heater temperature setting. When the heater turns off, the Pro Logic/Aqua Logic’s heater control will be in an automatic state. Pushing the heater button anytime while the heater is on, will shut the heater off and put the Pro Logic/Aqua Logic’s heater control in a manual off state.

NOTE: The LED indicator will illuminate whenever the heater is running. Also, the Pro Logic/Aqua Logic will never allow the water temperature to exceed 104°F (40°C).

Aux1 (Spa Filter): When Pool and Spa - Dual is selected, the “Aux1” button controls the Spa Filter and operates similar to the “Filter” function.

AQL-SS-D

The AQL-SS-D can only be used with Pro Logic PS models and Aqua Logic PS models running software version 2.40 or greater. It is similar to the AQL-SS-6B except that it has 2 more function buttons as well as 3 buttons underneath the LED display. The 8 functions operate in the same manner as the AQL-SS-6B. Refer to page 7 for this information.

The 3 buttons under the LED display are used to set temperatures, view temperatures and turn the display off. Pushing the center button will cycle the display to view “Spa” temperature, view “Air” temperature, view “Set” spa heater temperature and the last push will turn off the display. While the display is off, 3 dots will appear. This mode is convenient at night when the lit display is not desired. The up and down buttons are used to set the temperature of the heater when in “Set” mode. The displayed option (“Spa”, “Air” and “Set”) will initially be displayed for 3 seconds, then the actual temperature will be shown and remain on until the center button is pushed. To quickly determine which temperature is being displayed, air temperature will always be displayed with a decimal point, water temperature will have no decimal point and the set temperature will always blink. When the display is off, three dots will appear.

Troubleshooting

1. **No response to buttons:** Check that the Pro Logic/Aqua Logic has input power and the AQL-SS-6B/D cable is correctly wired to the terminal block according to page 4. If OK, cycle the Pro Logic/Aqua Logic's power off and on. If using the AQL-SS-6B and Aqua Logic software version 2.40 or greater, make sure that the buttons are properly configured in the configuration menu (page 5 - 6).
2. **“Er1” on display (AQL-SS-D only):** An AQL-SS-D is connected to a Pro Logic or Aqua Logic P-4. The AQL-SS-D is not compatible with any model P-4. Disconnect the AQL-SS-D and use an AQL-SS-6B if a spa side remote control is desired.

This error also occurs if a spaside remote control is connected to a Pro Logic or Aqua Logic PS without first turning off power. If this is the case, cycle power on the Pro Logic/Aqua Logic and the remote control should be recognized.

3. **“Er2” on display (AQL-SS-D only):** The most likely cause of this problem is a broken black and/or white wire or “open circuit” between the display/keypad and the Pro Logic/Aqua Logic main control unit. If you are unable to find the problem, contact the Goldline Technical Support department Monday through Friday, from 8AM to 8PM eastern time.
4. **“Er3” on display (AQL-SS-D only):** The black and white wires are reversed. Reverse these two wires to fix the problem. If this doesn't take care of the problem, contact the Goldline Technical Support department.
5. **Two blinking backlights (AQL-SS-6B only):** The most likely cause of this problem is a broken black and/or white wire or “open circuit” between the display/keypad and the Pro Logic/Aqua Logic main control unit. If you are unable to find the problem, contact the Goldline Technical Support department.
6. **Three blinking backlights (AQL-SS-6B only):** The black and white wires are reversed. Reverse these two wires to fix the problem. If this doesn't take care of the problem, contact the Goldline Technical Support department.
7. **Wrong response to buttons:** Check that the Pro Logic/Aqua Logic is in the proper mode, either “Pool and Spa -Std” or “Pool and Spa - Dual”.
8. **Erratic Operation:** If the operation appears erratic, turn off input power to the unit, wait one minute, then power back up. This should reset the microprocessor and return operation to normal.

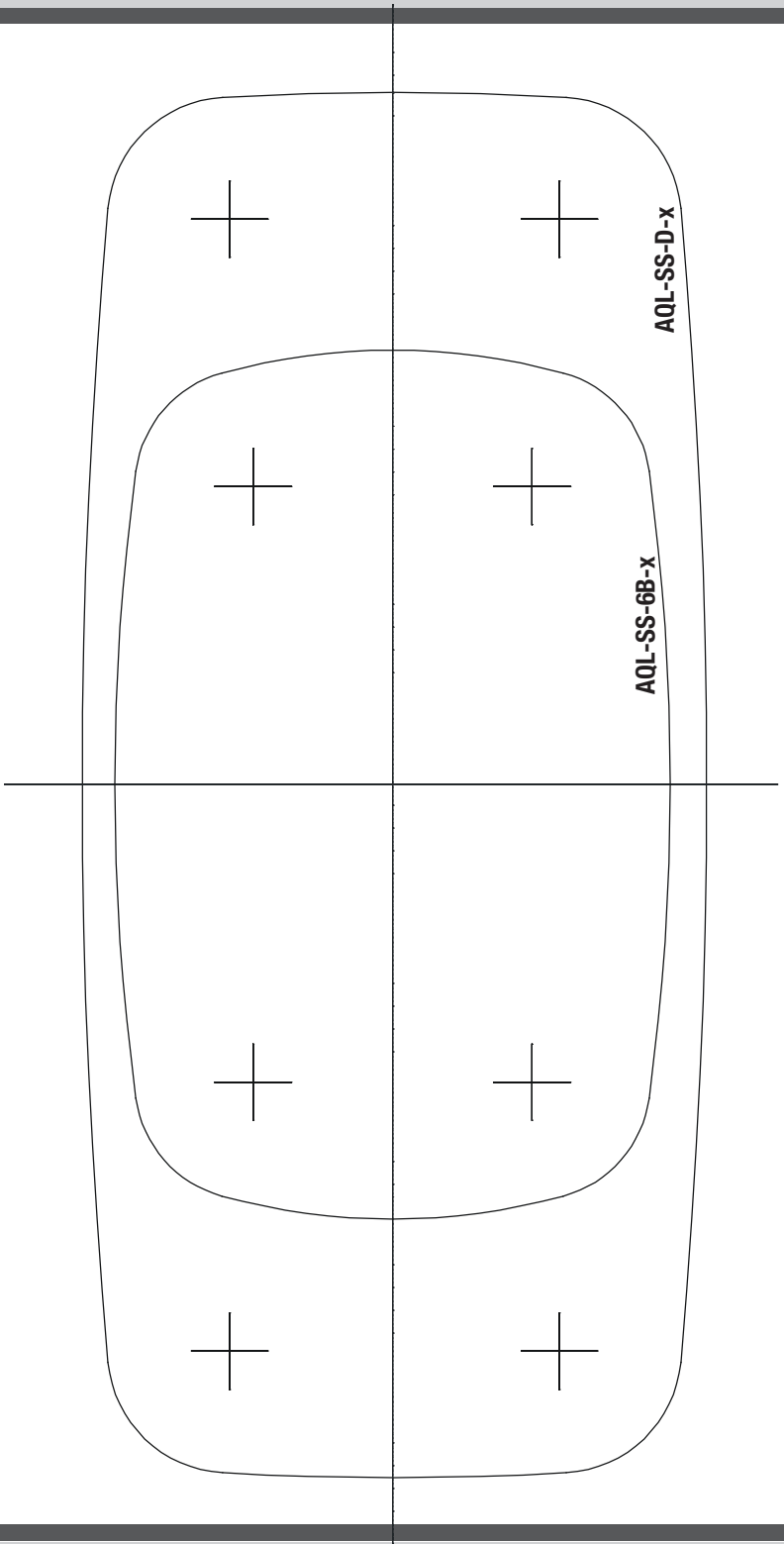









LIMITED WARRANTY (effective 03/01/12) Hayward warrants its Pro Logic, OnCommand and E-Command pool automation products as well as its Aqua Rite, Aqua Rite Pro, Aqua Plus and SwimPure chlorination products to be free of defects in materials and workmanship, under normal use and service, for a period of three (3) years. Hayward also warrants its Aqua Trol chlorination products to be free of defects in materials and workmanship, under normal use and service for a period of one (1) year. These warranties are applicable from the initial date of purchase on private residential swimming pools in the US and Canada. Installations of product for use on commercial pools in the US and Canada is covered for a period of one (1) year for defects in materials and workmanship. Hayward warrants all accessories and replacement parts for the above-identified pool automation and chlorination products for a period of one (1) year. Accessories also include remotes, actuators, base stations, temperature sensors, flow switches and chemistry probes. Each of these warranties is not transferable and applies only to the original owner.

Hayward shall not be responsible for cartage, removal, repair or installation labor or any other such costs incurred in obtaining warranty replacements or repair.

Proof of purchase is required for warranty service. If written proof of purchase is not provided, the manufacturing date code will be the sole determinant of the date of installation of the product. To obtain warranty service or repair, please contact the place of purchase or the nearest Hayward authorized warranty service center. For more information on authorized service centers please contact the Hayward Technical Service Support Center (61 Whitecap Road, North Kingstown RI, 02852) or visit the Hayward web site at www.hayward.com.

WARRANTY EXCLUSIONS:

1. Material supplied or workmanship performed by others in process of installation.
2. Damage resulting from improper installation including installation on pools larger than the product rating.
3. Problems resulting from failure to install, operate or maintain the product(s) in accordance with the recommendations contained in the owners manual(s).
4. Problems resulting from failure to maintain pool water chemistry in accordance with the recommendations in the owners manual(s).
5. Problems resulting from tampering, accident, abuse, negligence, unauthorized repairs or alternations, fire, flood, lightning, freezing, external water, degradation of natural stone used in or immediately adjacent to a pool or spa, war or acts of God.
6. Use of a non-genuine Hayward replacement salt chlorination cell on any Hayward automation or chlorination product will void the warranty for that product.

The express limited warranty above constitutes the entire warranty of Hayward Pool Products with respect to its products and is in lieu of all other warranties expressed or implied, including warranties of merchantability or fitness for a particular purpose. In no event shall Hayward Pool products be responsible for any consequential, special or incidental damages of any nature. Some states do not allow a limitation on how long an implied warranty lasts, or the exclusion of incidental or consequential damages, so the above limitation may not apply to you. This warranty gives you specific legal rights, and you may also

For further information or consumer
technical support, visit our website at
www.hayward.com



Hayward is a registered trademark of Hayward Industries, Inc. © 2016 Hayward Industries, Inc.

All other trademarks not owned by Hayward are the property of their respective owners.
Hayward is not in any way affiliated with or endorsed by those third parties.

USE ONLY HAYWARD GENUINE REPLACEMENT PARTS