



SPA PRODUCTS CATALOG



HYDROQUIP™
Premier providers of quality retrofit control systems



HYDROQUIP™

THE **SMART CHOICE**™

Your Resource Solution For Replacement Spa Parts

HydroQuip is the nation's oldest manufacturer of Portable Spa Equipment which includes controls that integrate Balboa®, Gecko and Pneumatic.

Our most recent addition has been the Laing and Therm heater products. HydroQuip's goal is to stock and provide an extensive selection of quality spa parts to the North American and European OEM & Distribution networks.

As a manufacturer and master distributor our goal is to be the preferred value added supplier of replacement spa parts, spa controls & equipment, baptistry controls, spa heater elements and heater assemblies, and the support services including technical and warranty assistance on all brands we offer including:

- **Balboa®** – Spa Controls, PC Boards, Spasides & Overlays, Heaters, Sensors, Wet Ends, Hot tub Jets and Fittings
- **Gecko** – Spa Controls, PC Boards, Spasides, Overlays, Heaters, Sensors, Etc.
- **Grundfos** – Spa Circulation Pumps
- **Laing** – E-3, E-5, E-10 and E-14 Circulation Pumps and Heaters
- **Therm Products** – Spa Heater Elements and Heater Assemblies
- **Related Metal Fabrication (RMF)** – Spa Heater Elements and Heater Assemblies
- **Truheat** – Spa Heater Elements and Heater Assemblies
- **Tecmark** – Pressure & Vacuum Switches, Air switches, Spaside Controls
- **Aquatemp** - Spa Heater Elements and Heater Assemblies

BALBOA
water group

GECKO

LAING

GRUNDFOS® 

PRODUCTS INC

TECMARK
CORPORATION



THERM
PRODUCTS™

RMF
RELATED
METAL FABRICATION INC



About us:

HydroQuip ... the Smart Choice

HydroQuip has been providing innovative, dependable and high quality portable spa and hot tub retrofit controls to the industry for over 30 years. HydroQuip continues to offer the broadest selection of controls and replacement parts to fit every spa or hot tub. We continue to lead the industry in innovation and “down to earth” product features by designing products that address the real needs and desires of today’s spa and hot tub retail dealers and service technicians.

“Down to Earth” features such as this long list of industry firsts:

<u>Electronic Controls</u>	Choice of Balboa® or Gecko Series
<u>Slide Heater Assembly</u>	Position the heater to your requirements
<u>Versi-Heat Remote Heaters</u>	Remote heater for added convenience
<u>Universal Retro-Fit System</u>	Complete ready to install bundled Control Kits
<u>Visual Diagnostic System*</u>	Provides easy system diagnostics
<u>System Mis-Wire Protection*</u>	Protection from improper electrical installations
<u>Universal Circuit Voltages</u>	Flexible circuit designs

**Air Series Only*

In addition to our innovative spa and hot tub products, you will find our customer service team to be unmatched in their first hand product knowledge. Our customer service, sales and technical support teams are all industry veterans that understand not only the product but the application spa customers encounter on a daily basis. We take great pride in our reputation for superior quality and responsive customer service, all at a competitive price.

In the following pages you will find a selection of products and replacement parts which address your new and retro-fit needs and marketing requirements. Please contact us if you have any additional needs, questions or requirements.

BALBOA® WATER PRO SERIES BY HYDROQUIP

PAGE

Product Update / Cross Reference	2
BP5 Universal Series Retrofit Kits	3
CS7000B Lite Leader Series	4
CS7000B Lite Leader SLIDE Heater Series	5
CS9700B Series	6

BALBOA® OEM RETRO-KITS AND CONTROL SYSTEMS

BP7 Series Retrofit Kits	8
VS Series Retrofit Kits	9
VS & BP Series Control Boxes	10

GECKO® SERIES SYSTEMS BY HYDROQUIP

CS6000Y SLIDE Series	12
CS4000Y SLIDE Series	13
CS6000Y Water Pro Series	14
Lo-Flo Circulation Series	15-16
CS9700Y Series	17
Product Update / Cross Reference	18

AIR SERIES SYSTEMS

CS6000 SLIDE Series	20
CS4000 SLIDE Series	21
CS7000 Economy Series	22
CS500/800 Series	23

OUTDOOR SERIES SYSTEMS

CS8800 Balboa BP Series by HydroQuip	26
ES8800 Balboa BP Series by HydroQuip	27
CS8800 Gecko Y Series by HydroQuip	28
ES8800 Gecko Y Series by HydroQuip	29
Heatmax Remote Heater Series	30

BLOWERS & PURE HEAT BATH HEATERS **PAGE**

Universal Silent Aire Blower Series	32
Pure Heat Bath Heaters - Tee Style	33
Pure Heat Bath Heaters - Inline Style	34

BAPTISMAL SERIES SYSTEMS

BES 6000 / 6000T Series Equipment Systems	36
BCS 6000 / 6000T Series Control Systems	37
Baptismal Accessories	38
BES 55 Series Equipment Systems	39
BCS 55 Series Control Systems	40
PBES6000 Series Portable Baptismal Systems	41
Immersion Heater Series	42

PARTS

Gecko Printed Circuit Boards & Eproms	44
Balboa Printed Circuit Boards	45-46
Gecko Spasides, Labels & Accessories	47-48
Balboa Spasides, Labels & Accessories	49-56
Air Series Spaside Controls	57
Switches - Air, Pressure, Flow	57-58
Relays & Contactors	59
Thermostats, High Limits & Timers	59
Sensors & Accessories	60-61
GFCI Cords/Plugs & Transformers	61
Fuses, Holders & Terminal Blocks	62
Ozones & Accessories	63
Sloan LED Lighting	64
PVC Parts, Tailpieces, Unions, Fittings & Accessories	65-67
Pumps - Circulation Pumps & Parts	68
Pumps - Spa & Bath Pumps	69
Pumps - LX Pumps	70
Pumps - Wet Ends	71-75
Baptismal Replacement Parts	76-77
Cords & Receptacles	78
Light Kits & Misc Hardware	79

HEATERS AND ELEMENTS**PAGE**

Universal Rite-Fit Heater Guide	82
Universal Rite-Fit Heater Series	83
Universal Lo-Flo Vertical Heater Series & Accessories	84-85
Double Barrel Lo-Flo Heater Replacement for Watkins	86
Water Pro Smart Heater Plus & Accessories	87
Lo-Flo Heater Replacements	88-89
Flo-Thru Heater Replacements	90-96
Balboa OEM Heater Replacements	97
Vertical Lo-Flo Heaters & Replacements	98-100
HQ Heater Replacements	101-106
Heater Element Replacements	107-108
HEATER ASSEMBLY CROSS REFERENCE GUIDE	109-128

NEEDS UPDATING



Balboa® Water Pro Series By HydroQuip



HYDROQUIP[™]
THE **SMART CHOICE**[™]

Made in the USA

PRODUCT UPDATE

The Balboa 6000B Water Pro and SLIDE Series Systems have been discontinued due to manufacturing changes and is being replaced by the Water Pro BP5 Series Systems. The replacement systems are listed below, see page X for more details.

6000B Balboa SLIDE Series(Discontinued)



Water Pro BP5 SLIDE Series



6000B Balboa Water Pro Series(Discontinued)



Water Pro BP5 Series



Cross Reference Information

Water Pro Series

SLIDE Series

Old Model	Replaced by	Spaside*	Old Model	Replaced by	Spaside*
CS6100B-U-WP	50-BP5-200-55-K	TP200	CS6109B-US	50-BP5-200-7S-K	TP200
CS6200B-U-WP	50-BP5-200-55-K	TP200	CS6209B-US	50-BP5-200-7S-K	TP200
CS6220B-U-WP	50-BP5-20E-55-K	TP200	CS6229B-US	50-BP5-20E-7S-K	TP200
CS6100B-U-F-WP	50-BP5-500-55-K	TP500	CS6109B-US-F	50-BP5-500-7S-K	TP500
CS6200B-U-F-WP	50-BP5-500-55-K	TP500	CS6209B-US-F	50-BP5-500-7S-K	TP500
CS6220B-U-F-WP	50-BP5-50E-55-K	TP500	CS6229B-US-F	50-BP5-50E-7S-K	TP500
CS6230B-U-WP	50-BP5-50E-55-K	TP500	CS6239B-US	50-BP5-50E-7S-K	TP500
CS6330B-U-WP	50-BP5-50E-55-K	TP500	CS6339B-US	50-BP5-50E-7S-K	TP500
CS6220B-UZ-WP	50-BP5-600-55-K	TP600	CS6229B-USZ	50-BP5-600-7S-K	TP600
CS6230B-UZ-WP	50-BP5-600-55-K	TP600	CS6239B-USZ	50-BP5-600-7S-K	TP600
CS6330B-UZ-WP	50-BP5-600-55-K	TP600	CS6339B-USZ	50-BP5-600-7S-K	TP600

*Spaside Included with replacement retro-kit

BP5 Series Retrofit Kits



Model #	Platform	Pump 1	Pump 2	Blower	Pump 3	Circ Pump	Htr Wattage	Spaside
50-BP5-200-40-K	BP5	1/2 SPD	1 SPD	1 SPD	N/A	Supported*	4.0kW	
50-BP5-20E-40-K	BP5	1/2 SPD	1/2 SPD or	1 SPD	N/A	Supported	4.0kW	
50-BP5-200-55-K	BP5	1/2 SPD	1 SPD	1 SPD	N/A	Supported*	5.5kW	
50-BP5-20E-55-K	BP5	1/2 SPD	1/2 SPD or	1 SPD	N/A	Supported	5.5kW	
50-BP5-200-5S-K	BP5	1/2 SPD	1 SPD	1 SPD	N/A	Supported*	4.0kW	
50-BP5-20E-5S-K	BP5	1/2 SPD	1/2 SPD or	1 SPD	N/A	Supported	4.0kW	
50-BP5-200-7S-K	BP5	1/2 SPD	1 SPD	1 SPD	N/A	Supported*	5.5kW	
50-BP5-20E-7S-K	BP5	1/2 SPD	1/2 SPD or	1 SPD	N/A	Supported	5.5kW	
50-BP5-500-40-K	BP5	1/2 SPD	1 SPD	1 SPD	N/A	Supported*	4.0kW	
50-BP5-50E-40-K	BP5	1/2 SPD	1/2 SPD	1 SPD or	1 SPD	Supported	4.0kW	
50-BP5-500-55-K	BP5	1/2 SPD	1 SPD	1 SPD	N/A	Supported*	5.5kW	
50-BP5-50E-55-K	BP5	1/2 SPD	1/2 SPD	1 SPD or	1 SPD	Supported	5.5kW	
50-BP5-500-5S-K	BP5	1/2 SPD	1 SPD	1 SPD	N/A	Supported*	4.0kW	
50-BP5-50E-5S-K	BP5	1/2 SPD	1/2 SPD	1 SPD or	1 SPD	Supported	4.0kW	
50-BP5-500-7S-K	BP5	1/2 SPD	1 SPD	1 SPD	N/A	Supported*	5.5kW	
50-BP5-50E-7S-K	BP5	1/2 SPD	1/2 SPD	1 SPD or	1 SPD	Supported	5.5kW	
50-BP5-600-40-K	BP5	1/2 SPD	1/2 SPD	1 SPD	1 SPD	Supported	4.0kW	
50-BP5-600-55-K	BP5	1/2 SPD	1/2 SPD	1 SPD or	1 SPD	Supported	5.5kW	
50-BP5-600-5S-K	BP5	1/2 SPD	1/2 SPD	1 SPD	1 SPD	Supported	4.0kW	
50-BP5-600-7S-K	BP5	1/2 SPD	1/2 SPD	1 SPD or	1 SPD	Supported	5.5kW	
50-BP5-700-40-K	BP5	1/2 SPD	1/2 SPD	1 SPD**	1 SPD	Supported	4.0kW	
50-BP5-700-55-K	BP5	1/2 SPD	1/2 SPD	1 SPD**	1 SPD	Supported	5.5kW	
50-BP5-700-5S-K	BP5	1/2 SPD	1/2 SPD	1 SPD**	1 SPD	Supported	4.0kW	
50-BP5-700-7S-K	BP5	1/2 SPD	1/2 SPD	1 SPD**	1 SPD	Supported	5.5kW	
50-BP5-800-40-K	BP5	1/2 SPD	1/2 SPD	1 SPD**	1 SPD	Supported	4.0kW	
50-BP5-800-55-K	BP5	1/2 SPD	1/2 SPD	1 SPD**	1 SPD	Supported	5.5kW	
50-BP5-800-5S-K	BP5	1/2 SPD	1/2 SPD	1 SPD**	1 SPD	Supported	4.0kW	
50-BP5-800-7S-K	BP5	1/2 SPD	1/2 SPD	1 SPD**	1 SPD	Supported	5.5kW	

*When programmed for Circ Pump, P1 changes to one speed Only

**P4 or Blower Option

SYSTEM SPECIFICATIONS

ELECTRICAL INPUT SPECIFICATION: SINGLE PHASE, 120/240VAC, 60HZ

ELECTRICAL OUTPUT SPECIFICATION:

CIRCUIT(S)	MAXIMUM AMPS	CIRCUIT(S)	MAXIMUM AMPS
PUMP(S)	11A	CIRC PUMP	4A
BLOWER	11A	LIGHT	2A
OZONE	1A	HEATER	23A

*REQUIRED FLOW RATE: 25 GPM
 SYSTEM DIMENSIONS: 15"W x 12"H x 6"D
 SHIPPING WEIGHT: 15 LBS
 PACKAGING / SHIPPING : INDIVIDUAL
 FOB CORONA, CA 92878

SYSTEMS INCLUDE

Kit Includes:

- Spaside Control
- Spaside Label
- Spaside Adapter Plate
- 2" Tailpieces w/Gaskets
- 12V Light Assembly w/LED





CS7000B Water Pro SLIDE Lite Leader Series

STANDARD FEATURES

- 1.375/5.5KW or 1.0/4.0KW, Slide 15" Heater Assembly
- EZ Access Foot Heater
- Spaside Control - Available as a 2 button or 4 button
- Filtration Cycles - Programmable Duration*
- 12V Light Assembly
- All Circuits Convertible to 120 or 240VAC
- Heater "ON" Indicator Light
- Freeze Protection
- Brushed Aluminum Enclosure
- Easy To Install & Service
- Installation Kit (see below)
- Detailed Owner's Manual & Wiring Diagram



Model	Platform	Pump 1	Pump 2	Blower	Circ Pump	Htr Wattage	Spaside Included
CS7109B-US-15A	LITE LDR	2 SPD	N/A	N/A	N/A	1.0kW	 Lite Leader 2BTN Series 4.5"L x 2.25"H
CS7109B-US-4.0	LITE LDR	2 SPD	N/A	N/A	N/A	4.0kW	
CS7109B-US	LITE LDR	2 SPD	N/A	N/A	N/A	5.5kW	
CS7109B-US-15A-F	LITE LDR ICON15	2 SPD	N/A	N/A	N/A	1.0kW	 Lite Leader ICON15 4BTN Series 6.3"L x 2.2"H
CS7109B-US-4.0-F	LITE LDR ICON15	2 SPD	N/A	N/A	N/A	4.0kW	
CS7109B-US-F	LITE LDR ICON15	2 SPD	N/A	N/A	N/A	5.5kW	

For a complete list of parts, refer to our Replacement Parts Section in the back of this catalog

SYSTEM SPECIFICATIONS

ELECTRICAL INPUT SPECIFICATION: SINGLE PHASE, 120/240VAC, 60HZ

ELECTRICAL OUTPUT SPECIFICATION:

CIRCUIT(S)	MAXIMUM AMPS
PUMP	12A
OZONE	1A
LIGHT	1A
HEATER	23A (5.5KW) OR 18A (4.0KW)

REQUIRED FLOW RATE:

25 GPM

SYSTEM DIMENSIONS:

15"W x 10"H x 5"D

SHIPPING WEIGHT:

15 LBS

PACKAGING / SHIPPING :

INDIVIDUAL (HQ STOCK)
 FOB CORONA, CA 92878

INSTALLATION KIT (Included)

Kit Includes:

- Spaside Control (see above)
- Spaside Label
- Spaside Adapter Plate 8.5"L x 4"H
- 48" Component Cords
- 2" Tailpieces w/Gaskets
- 12V Light Assembly
- Cord Adapters
- Heater Clamps



WARRANTY:

2 YEAR LIMITED WARRANTY STANDARD

Call (951) 273-7575



CS7000B WaterPro Lite Leader Series

STANDARD FEATURES

- 1.375/5.5KW or 1.0/4.0KW, Fixed 15" Heater Assembly
- EZ Access Foot Heater
- Spaside Control - Available as a 2 button or 4 button
- Filtration Cycles - Programmable Duration*
- 12V Light Assembly
- All Circuits Convertible to 120 or 240VAC
- Heater "ON" Indicator Light
- Freeze Protection
- Amp Receptacles
- Brushed Aluminum Enclosure
- Easy To Install & Service
- Installation Kit (see below)
- Detailed Owner's Manual & Wiring Diagram



2 Button Spaside Shown

Model	Platform	Pump 1	Pump 2	Blower	Circ Pump	Htr Wattage	Spaside Included
CS7100B-U-15A-WP	LITE LDR	2 SPD	N/A	N/A	N/A	1.0kW	 Lite Leader 2BTN Series 4.5"L x 2.25"H
CS7100B-U-4.0-WP	LITE LDR	2 SPD	N/A	N/A	N/A	4.0kW	
CS7100B-U-WP	LITE LDR	2 SPD	N/A	N/A	N/A	5.5kW	
CS7100B-U-15A-WP-F	LITE LDR ICON15	2 SPD	N/A	N/A	N/A	1.0kW	 Lite Leader ICON15 4BTN Series 6.3"L x 2.2"H
CS7100B-U-4.0-WP-F	LITE LDR ICON15	2 SPD	N/A	N/A	N/A	4.0kW	
CS7100B-U-WP-F	LITE LDR ICON15	2 SPD	N/A	N/A	N/A	5.5k	

For a complete list of parts, refer to our Replacement Parts Section in the back of this catalog

INSTALLATION KIT (Included)

Kit Includes:

- Spaside Control (see above)
- Spaside Label
- Spaside Adapter Plate
8.5"L x 4"H
- 48" Component Cords
- 2" Tailpieces w/Gaskets
- 12V Light Assembly



SYSTEM SPECIFICATIONS

ELECTRICAL INPUT SPECIFICATION: SINGLE PHASE, 120/240VAC, 60HZ

ELECTRICAL OUTPUT SPECIFICATION:

CIRCUIT(S)	MAXIMUM AMPS
PUMP	12A
OZONE	1A
LIGHT	1A
HEATER	23A (5.5KW) OR 18A (4.0KW)

REQUIRED FLOW RATE:

25 GPM

SYSTEM DIMENSIONS:

15"W x 10"H x 5"D

SHIPPING WEIGHT:

18 LBS

PACKAGING / SHIPPING :

INDIVIDUAL (HQ STOCK)
FOB CORONA, CA 92878

WARRANTY:

2 YEAR LIMITED WARRANTY STANDARD



CS9700B Series

STANDARD FEATURES

- 1.00/4.0KW, 16.25" Heater Assembly
- EZ Access Foot Heater
- Spaside Control
- 12V Light Assembly
- All Circuits Convertible to 120 or 240VAC
- Heater "ON" Indicator Light
- Smart-Econ Economy Mode Settings
- Smart-Freeze Protection
- Installation Kit (see below)
- Easy to Install & Service
- Detailed Owner's Manual & Wiring Diagram



Includes Spaside

Model	Platform	Pump 1	Pump 2	Pump 3	Blower	Ozone	Circ Pump	12V Light	Spaside Included
CS9709B-U-ML550-4.0	EL2000	1 or 2 SPD	1 or 2 SPD	1 SPD	1 SPD	YES	YES	YES	 PT# 34-53392-K ML550, 13.7"L x 2.5"H
CS9709B-U-ML700-4.0	EL2000	1 or 2 SPD	1 or 2 SPD	1 SPD	1 SPD	YES	YES	YES	 PT# 34-52649-K ML700, 9.8"L x 3.1"H

Add (-VH) suffix to Model number for Versi-Heat Series w/ 60" Htr Cord
 Add (-LH) suffix to Model number for Less Heater Series

SYSTEM SPECIFICATIONS

ELECTRICAL INPUT SPECIFICATION: SINGLE PHASE, 120/240VAC, 60HZ

ELECTRICAL OUTPUT SPECIFICATION:

CIRCUIT(S)	MAXIMUM AMPS
PUMP(S)	13A
BLOWER	8A
OZONE	2A
CIRCULATION PUMP	5A
LIGHT	1A
HEATER	23A

SYSTEM DIMENSIONS: 22.5"W x 14.75"H x 7"D

DIMENSIONS OF CONTROL BOXES & SHIPPING WEIGHT:

CS9xx4:	22.5"W x 14.75"H x 7"D	23 LBS
---------	------------------------	--------

INSTALLATION KIT (Included)

Kit Includes:

- Spaside Control (see above)
- Spaside Label
- Spaside Adapter Plate
- 48" Component Cords
- 2" Tailpieces w/Gaskets
- 12V Light Assembly
- Cord Adapters
- Heater Clamps



WARRANTY:
 2 YEAR LIMITED WARRANTY STANDARD



Balboa® OEM Retro Kits & Controls



HYDROQUIP™
THE **SMART CHOICE™**





Made in the USA

BP7 Series Retrofit Kit

STANDARD FEATURES

- M8® Technology Equipped
- With 1.375/5.5KW or 1.0/4.0KW Heater
- Spaside Control
- 12V Light Assembly w/LED
- All Circuits Convertible to 120 or 240VAC
- Amp Receptacles
- Freeze Protection
- Easy To Install & Service
- Installation Kit (see below)
- Detailed Owner's Manual & Wiring Diagram
- US and Canada UL Recognized



Model #	Heater	Pump 1	Pump 2	Blower	Pump 3	Circ Pump*	Htr Wattage	Spaside
50-BP7-200-40-K	Fixed	1/2 SPD	1/2 SPD	or 1 SPD	N/A	Supported	4.0kW	 TP200 Series 5.3"L x 1.9"H
50-BP7-200-55-K	Fixed	1/2 SPD	1/2 SPD	or 1 SPD	N/A	Supported	5.5kW	
50-BP7-500-40-K	Fixed	1/2 SPD	1/2 SPD	or 1 SPD	N/A	Supported	4.0kW	 TP500 Series 6.32"L x 2.25"H
50-BP7-500-55-K	Fixed	1/2 SPD	1/2 SPD	or 1 SPD	N/A	Supported	5.5kW	
50-BP7-600-40-K	Fixed	1/2 SPD	1/2 SPD	1 SPD	or 1 SPD	Supported	4.0kW	 TP600 Series 7.1"L x 3.5"H
50-BP7-600-55-K	Fixed	1/2 SPD	1/2 SPD	1 SPD	or 1 SPD	Supported	5.5kW	
50-BP7-700-40-K	Fixed	1/2 SPD	1/2 SPD	1 SPD**	1 SPD	Supported	4.0kW	 TP700 Series 10"L x 3.5"H
50-BP7-700-55-K	Fixed	1/2 SPD	1/2 SPD	1 SPD**	1 SPD	Supported	5.5kW	
50-BP7-800-40-K	Fixed	1/2 SPD	1/2 SPD	1 SPD**	1 SPD	Supported	4.0kW	 TP800 Series 10"L x 3.5"H
50-BP7-800-55-K	Fixed	1/2 SPD	1/2 SPD	1 SPD**	1 SPD	Supported	5.5kW	

**Pump 4 or Blower Option

SYSTEMS INCLUDE

Kit Includes:

- Spaside Control
- Spaside Label
- Spaside Adapter Plate
- 2" Tailpieces w/Gaskets
- 12V Light Assembly w/LED



SYSTEM SPECIFICATIONS

ELECTRICAL INPUT SPECIFICATION: SINGLE PHASE, 120/240VAC, 60HZ

ELECTRICAL OUTPUT SPECIFICATION:

CIRCUIT(S)	MAXIMUM AMPS
PUMP(S)	11A
BLOWER	11A
OZONE	1A
CIRCULATION PUMP	4A
LIGHT	2A
HEATER	23A

***REQUIRED FLOW RATE:**

25 GPM

SYSTEM DIMENSIONS:

15"W x 12"H x 6"D

SHIPPING WEIGHT:

15 LBS

PACKAGING / SHIPPING :





INDIVIDUAL
 FOB CORONA, CA 92878

VS Series Retrofit Kits

STANDARD FEATURES

- M7® Technology Equipped
- 1.325/5.5KW, 15" Heater Assembly
- 1.0/4.0KW, 10" Heater Assembly(VS100)
- Spaside Control & Adapter Plate Included
- 12V Light Assembly w/LED
- All Circuits Convertible to 120 or 240VAC
- Standard, Economy & Sleep Modes
- Easy To Install & Service
- US and Canada UL Recognized



BWG# HQ#	Platform	Pump 1	Pump 2	Blower	Circ Pump*	Htr Wattage	Spaside
54219-Z 50-54219-Z	VS500Z	2 SPD	N/A	N/A	YES	5.5kW	
54220-Z 50-54220-Z	VS501Z	2 SPD	1 SPD** or	BLOWER**	YES	5.5kW	VL-200 Series LCD 4.3"L x 1.6"H
54216-Z 50-54216-Z	VS500Z	2 SPD	N/A	N/A	YES	5.5kW	
54217-Z 50-54217-Z	VS501Z	2 SPD	1 SPD** or	BLOWER**	YES	5.5kW	VL-403 Series LED 6.3"L x 2.2"H
54218-Z 50-54218-Z	VS510SZ	2 SPD	1 SPD	1 SPD (12A)	YES	5.5kW	
							VL701S Series LCD 7.4"L x 3.2"H
54808-Z 50-54808-A2	VS100	2 SPD	N/A	N/A	N/A	4.0kW	
							VL-200 Series LCD 4.3"L x 1.6"H

** Pump 2 OR Blower

SYSTEMS INCLUDE

Kit Includes:

- Spaside Control
- Spaside Label
- Spaside Adapter Plate
8.5"L x 4"H
- 2" Tailpieces w/Gaskets
- 12V Light Assembly



SYSTEM SPECIFICATIONS

ELECTRICAL INPUT SPECIFICATION: SINGLE PHASE, 120/240VAC, 60HZ

ELECTRICAL OUTPUT SPECIFICATION:

CIRCUIT(S)	MAXIMUM AMPS
PUMP(S)	12A
BLOWER	12A
OZONE	1A
CIRCULATION PUMP	4A
LIGHT	1A
HEATER	23A

***REQUIRED FLOW RATE:**

25 GPM

SYSTEM DIMENSIONS:

15"W x 11"H x 5"D

SHIPPING WEIGHT:

14 LBS

PACKAGING / SHIPPING :

INDIVIDUAL
FOB CORONA, CA 92878

Control Boxes Only



See pages 9.5-9.8 for all available Spaside controls

VS STANDARD FEATURES

- M7™Technology Equipped
- 1.325/5.5KW Heater
- All Circuits Convertible to 120 or 240VAC
- Amp Receptacles
- Freeze Protection
- Standard, Economy & Sleep Modes
- Easy To Install & Service
- US and Canada UL Recognized

BP STANDARD FEATURES

- M8™Technology Equipped
- 1.375/5.5KW or 1.0/4.0KW Heater
- All Circuits Convertible to 120 or 240VAC
- WiFi Capable
- Amp Receptacles
- Freeze Protection
- Easy To Install & Service
- US and Canada UL Recognized

VS Duplex Series

HQ#	Platform	Htr Wattage	Htr Material
51-54808-Z-K	VS100	1.0/4.0	Incoloy
51-54368-Z-K	VS500Z	5.5	Incoloy
51-54379-Z-K	VS501Z	4.0	Incoloy
51-56258-Z-K	VS501Z	4.0	Titanium
51-54356-Z-K	VS501Z	5.5	Incoloy

VS Serial Standard/Deluxe Series

HQ#	Platform	Htr Wattage	Htr Material
51-54377-Z-K	VS501SZ	5.5	Incoloy
51-54559-Z-K	VS510SZ	4.0	Incoloy
51-54371-Z-K	VS510SZ	5.5	Incoloy
51-56007-Z-K	VS520SZ	5.5	Incoloy
51-56016-Z-K	VS520DZ	5.5	Incoloy

BP5, BP7, BP2000 Series

HQ#	Platform	Htr Wattage	Htr Material
51-59187-Z-K	BP100	5.5	Incoloy
51-59372-Z-K	BP501U	4.0	Incoloy
51-59373-Z-K	BP501U	5.5	Incoloy

HQ#	Platform	Htr Wattage	Htr Material
51-G4361-K	BP7	4.0	Incoloy
51-G5361-K	BP7	5.5	Incoloy
51-56377-Z-K	BP2000G1	5.5	Incoloy

OPTIONAL ACCESSORIES

LIGHT ASSEMBLY (Sold Separately)

37-0001 Spa Light Assembly



PLACARDS (Sold Separately)



- 80-11718 VL200, VL240, VL260
- 80-11109 VL400, VL401, VL403
- 80-10165 VL402, VI404
- 80-15380 VL406U

COMPONENT CORDS (Sold Separately)

- 30-1001A 72" Amp Cord, 14/4
- 30-0018 48" Amp Cord, 18/3
- 30-0024-K 72" Amp Cord, 14/3



SYSTEM SPECIFICATIONS

ELECTRICAL INPUT SPECIFICATION: SINGLE PHASE, 120/240VAC, 60HZ

ELECTRICAL OUTPUT SPECIFICATION:

CIRCUIT(S)	MAXIMUM AMPS
PUMP(S)	12A
BLOWER	12A
OZONE	1A
CIRCULATION PUMP	4A
LIGHT	1A
HEATER	23A

*REQUIRED FLOW RATE:

25 GPM

SYSTEM DIMENSIONS VS/BP:

15"W x 11"H x 6"D

SYSTEM DIMENSIONS BP2000:

15"W x 12"H x 6"D

SYSTEM DIMENSIONS VS100:

7.5"W x 6.5"H x 2.5"D

SHIPPING WEIGHT:

11 LBS

PACKAGING / SHIPPING :

INDIVIDUAL
FOB CORONA, CA 92878



Gecko Series by Hydro-Quip



HYDROQUIP
THE **SMART CHOICE**[™]

Made in the USA

CS6000Y SLIDE Series

STANDARD FEATURES

- 1.375/5.5KW, 15" SLIDE Heater Assembly
- Wi-Fi Enabled*
- EZ Access Foot Heater
- Spaside Control
- 12V Light Assembly
- All Circuits Convertible to 120 or 240VAC
- Heater "ON" Indicator Light
- Pressure Switch Protection
- Smart-Freeze Protection
- Easy to Install & Service
- Installation Kit (see below)
- Detailed Owners Manual & Wiring Diagram





HEATER SLIDES FROM BOTTOM TO TOP!

Includes Spaside



OPTIONS

- Versi-Heat Remote Heater with 60" Cords
- Various Heater Wattages
- Less Heater Model

Model	Platform	Pump 1	Pump 2	Blower	Ozone	Circ Pump	Htr Wattage	Spaside Included
CS6209Y-US CS6229Y-US	ye-5 ye-5	2 SPD 2 SPD	1 SPD** or 2 SPD	BLOWER** N/A	YES YES	YES YES	5.5kW 5.5kW	 in.k200 Series 4.75"L x 2"H
CS6209Y-US-F CS6229Y-US-F	ye-5 ye-5	2 SPD 2 SPD	1 SPD** or 2 SPD	BLOWER** N/A	YES YES	YES YES	5.5kW 5.5kW	 in.k19 Spaside 7"L x 3.25"H
CS6239Y-US CS6339Y-US	ye-5 ye-5	2 SPD 2 SPD	1 SPD 2 SPD	1 SPD (8A) 1 SPD (8A)	YES YES	YES YES	5.5kW 5.5kW	 in.k450 Spaside 7"L x 3.25"H, 10' Cord

Add (-VH) suffix to Model number for Versi-Heat Series w/ 60" Htr Cord
Add (-LH) suffix to Model number for Less Heater Series

** Pump 2 or Blower only

IN-TOUCH2 MODULE (OPTIONAL)

* Requires Wi-Fi Module Kit PT# 34-0216G-K



INSTALLATION KIT (Included)

Kit Includes:

- Spaside Control
- Spaside Label
- Spaside Adapter Plate
- 48" Component Cords
- 2" Tailpieces w/Gaskets
- 12V Light Assembly



SYSTEM SPECIFICATIONS

ELECTRICAL INPUT SPECIFICATION: SINGLE PHASE, 120/240VAC, 60HZ
ELECTRICAL OUTPUT SPECIFICATION:

CIRCUIT(S)	MAXIMUM AMPS	CIRCUIT(S)	MAXIMUM AMPS
PUMP(S)	13A	CIRC PUMP	5A
BLOWER	8A	LIGHT	1A
OZONE	2A	HEATER	23A

SYSTEM DIMENSIONS: 15"W x 11"H x 4"D
SHIPPING WEIGHT: 14 LBS
PACKAGING / SHIPPING : INDIVIDUAL (HQ STOCK)
FOB CORONA, CA 92878

2 YEAR LIMITED WARRANTY STANDARD

CS4000Y SLIDE Series Pump Mount

STANDARD FEATURES

- 1.375/5.5KW, 15" SLIDE L Shaped Heater Assembly
- Wi-Fi Enabled*
- EZ Access Foot Heater
- Spaside Control
- 12V Light Assembly
- All Circuits Convertible to 120 or 240VAC
- Heater "ON" Indicator Light
- Pressure Switch Protection
- Smart-Freeze Protection
- Easy to Install & Service
- Installation Kit (see below)
- Detailed Owners Manual & Wiring Diagram



Includes Spaside



OPTIONS

- Versi-Heat Remote Heater with 60" Cords
- Various Heater Wattages
- Less Heater Model

Model	Platform	Pump 1	Pump 2	Blower	Ozone	Circ Pump	Htr Wattage	Spaside Included
CS4209Y-US CS4229Y-US	ye-5 ye-5	2 SPD 2 SPD	1 SPD** or 2 SPD	BLOWER** N/A	YES YES	YES YES	5.5kW 5.5kW	 in.k200 Series 4.75"L x 2"H
CS4209Y-US-F CS4229Y-US-F	ye-5 ye-5	2 SPD 2 SPD	1 SPD** or 2 SPD	BLOWER** N/A	YES YES	YES YES	5.5kW 5.5kW	 in.k19 Spaside 7"L x 3.25"H
CS4239Y-US CS4339Y-US	ye-5 ye-5	2 SPD 2 SPD	1 SPD 2 SPD	1 SPD (8A) 1 SPD (8A)	YES YES	YES YES	5.5kW 5.5kW	 in.k450 Spaside 7"L x 3.25"H, 10' Cord

** Pump 2 or Blower only

Add (-VH) suffix to Model number for Versi-Heat Series w/ 60" Htr Cord
Add (-LH) suffix to Model number for Less Heater Series

IN-TOUCH2 MODULE (OPTIONAL)

* Requires Wi-Fi Module Kit
PT# 34-0216G-K



INSTALLATION KIT (Included)

Kit Includes:

- Spaside Control
- Spaside Label
- Spaside Adapter Plate
- 48" Component Cords
- 2" Tailpieces w/Gaskets
- 12V Light Assembly



SYSTEM SPECIFICATIONS

ELECTRICAL INPUT SPECIFICATION: SINGLE PHASE, 120/240VAC, 60HZ

ELECTRICAL OUTPUT SPECIFICATION:

CIRCUIT(S)	MAXIMUM AMPS	CIRCUIT(S)	MAXIMUM AMPS
PUMP(S)	13A	CIRC PUMP	5A
BLOWER	8A	LIGHT	1A
OZONE	2A	HEATER	23A

SYSTEM DIMENSIONS: 15"W x 11"H x 4"D

SHIPPING WEIGHT: 14 LBS

PACKAGING / SHIPPING : INDIVIDUAL (HQ STOCK)
FOB CORONA, CA 92878

2 YEAR LIMITED WARRANTY STANDARD

CS6000Y WaterPro Series

STANDARD FEATURES

- Fixed 1.375/5.5KW, 15" Heater Assembly
- Wi-Fi Enabled*
- EZ Access Foot Heater
- Spaside Control
- 12V Light Assembly
- All Circuits Convertible to 120 or 240VAC
- Heater "ON" Indicator Light
- Amp Receptacles
- Smart-Freeze Protection
- Pressure Switch Protected
- Installation Kit (see below)
- Detailed Owner's Manual & Wiring Diagram
- US and Canada UL Recognized
- *Requires optional Wi-Fi Module



Includes Spaside



Model	Platform	Pump 1	Pump 2	Blower	Ozone	Circ Pump	Htr Wattage	Spaside Included
CS6200Y-U-WP CS6220Y-U-WP	ye-5 ye-5	2 SPD 2 SPD	1 SPD** or 2 SPD	BLOWER** N/A	YES YES	YES YES	5.5kW 5.5kW	 in.k200 Series 4.75"L x 2"H
CS6230Y-U-WP CS6330Y-U-WP	ye-5 ye-5	2 SPD 2 SPD	1 SPD 2 SPD	1 SPD (8A) 1 SPD (8A)	YES YES	YES YES	5.5kW 5.5kW	 in.k450 Spaside 7"L x 3.25"H, 10' Cord

Add (-VH) suffix to Model number for Versi-Heat Series w/ 60" Htr Cord
Add (-LH) suffix to Model number for Less Heater Series

** Pump 2 or Blower only

IN-TOUCH2 MODULE (OPTIONAL)

* Requires Wi-Fi Module Kit
PT# 34-0216G-K



INSTALLATION KIT (Included)

Kit Includes:

- Spaside Control
- Spaside Label
- Spaside Adapter Plate
- 48" Component Cords
- 2" Tailpieces w/Gaskets
- 12V Light Assembly



SYSTEM SPECIFICATIONS

ELECTRICAL INPUT SPECIFICATION: SINGLE PHASE, 120/240VAC, 60HZ
ELECTRICAL OUTPUT SPECIFICATION:

CIRCUIT(S)	MAXIMUM AMPS	CIRCUIT(S)	MAXIMUM AMPS
PUMP(S)	13A	CIRC PUMP	5A
BLOWER	8A	LIGHT	1A
OZONE	2A	HEATER	23A

SYSTEM DIMENSIONS: 15"W x 11"H x 4"D
SHIPPING WEIGHT: 14 LBS
PACKAGING / SHIPPING : INDIVIDUAL (HQ STOCK)
FOB CORONA, CA 92878

2 YEAR LIMITED WARRANTY STANDARD

YE-5 Series with Slipstream Heater

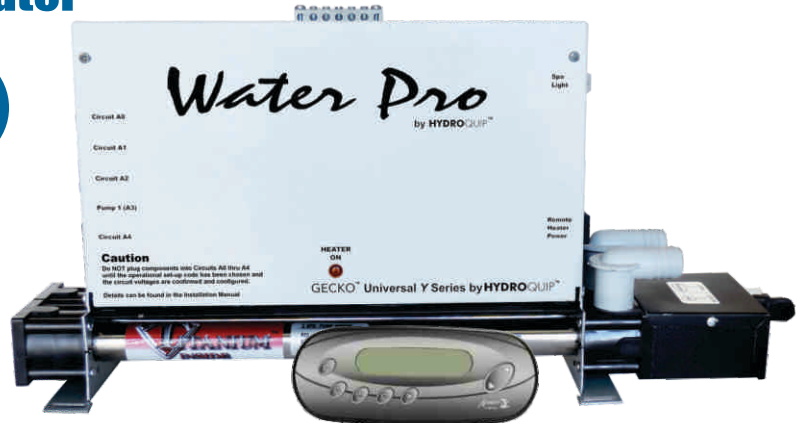

STANDARD FEATURES

- HQ YE-5 Platform
- 1.375/5.5kW Lo-Flo Slide Heater Assy
- Wi-Fi Capable*
- Spaside Control (Varies depending on model)
- 12V Light Assembly
- Heater "ON" Indicator Light
- Titanium Low Watt Density Heater Element
- 3/4" x 1" Barb Adapter
- Smart-Freeze Protection
- Flow Switch Protected
- Installation Kit (see below)
- Detailed Owner's Manual & Wiring Diagram
- US and Canada UL Recognized
- *Requires optional Wi-Fi Module



OPTIONS

Other Wattages Available

Model	Platform	Pump 1	Pump 2	Blower/Pump 3	Ozone	Circ Pump	Htr Wattage	Spaside Included
CS6P52Y-US	ye-5	1/2 SPD	1/2 SPD	1 SPD	YES	YES	5.5kW	 in.k200 Spaside
CS6P52Y-US-4	ye-5	1/2 SPD	1/2 SPD	1 SPD	YES	YES	5.5kW	 in.k450 Spaside
CS6P52Y-US-8	ye-5	1/2 SPD	1/2 SPD	1 SPD	YES	YES	5.5kW	 in.k8 Spaside

SYSTEM PROGRAMMING CONFIGURATIONS

Program	Pump 1	Pump 2/Blower	Pump 3/Blower	CP	Ozone
1	2 SPD - (A3)	NA	NA	NA	YES - (A4)
2	2 SPD - (A3)	NA	NA	24 HR - (A1)	YES - (A4)
3	2 SPD - (A3)	NA	NA	THERM - (A1)	YES - (A4)
4	2 SPD - (A3)	1 SPD - (A2)	NA	NA	YES - (A4)
5	2 SPD - (A3)	1 SPD - (A2)	NA	24 HR - (A1)	YES - (A4)
6	2 SPD - (A3)	1SPD - (A2)	NA	THERM - (A1)	YES - (A4)
7	2 SPD - (A3)	2 SPD - (A2)	NA	NA	YES - (A1)
8	2 SPD - (A3)	2 SPD - (A2)	NA	24 HR - (A1)	YES - (A1)
9	2 SPD - (A3)	2 SPD - (A2)	NA	THERM - (A1)	YES - (A1)
10	2 SPD - (A3)	1 SPD - (A2)	1 SPD - (A1)	NA	YES - (A4)
11	2 SPD - (A3)	1SPD - (A2)	1 SPD - (A1)	24 HR - (A4)	YES - (A4)
12	2 SPD - (A3)	1SPD - (A2)	1 SPD - (A1)	THERM - (A4)	YES - (A4)
13	2 SPD - (A3)	2 SPD - (A2)	1 SPD - (A1)	NA	YES - (A4)
14	2 SPD - (A3)	2SPD - (A2)	1 SPD - (A1)	24 HR* - (A0)	YES - (A0)
15	1 SPD - (A3)	NA	1 SPD - (A1)	24 HR - (A4)	YES - (A4)
16	1 SPD - (A3)	1 SPD - (A2)	1 SPD - (A1)	24 HR - (A4)	YES - (A4)

IN-TOUCH2 MODULE (OPTIONAL)



*Wi-Fi Module Kit
PT# 34-0216G-K

INSTALLATION KIT (Included)

Kit Includes:

- Spaside Control (See above)
- Spaside Label
- Spaside Adapter Plate
- 48" Component Cords
- Flow Switch Tee Assy
- 3/4" Clear Tubing
- SS Clamps
- 12V Light Assembly
- 3/4" X 1" Barb Adapter



SYSTEM SPECIFICATIONS

ELECTRICAL INPUT SPECIFICATION: SINGLE PHASE, 120/240VAC, 60HZ
ELECTRICAL OUTPUT SPECIFICATION:

CIRCUIT(S)	MAXIMUM AMPS
PUMP(S)	13A
BLOWER	8A
OZONE	2A
CIRCULATION PUMP	5A
LIGHT	1A
HEATER	23A

YE-5 Series with Slide Heater



STANDARD FEATURES

- HQ YE-5 Platform
- 1.375/5.5kW Slide Heater Assy
- Wi-Fi Capable*
- Spaside Control (Varies depending on model)
- 12V Light Assembly
- Heater "ON" Indicator Light
- Smart-Freeze Protection
- Pressure Switch Protected
- Installation Kit (see below)
- Detailed Owner's Manual & Wiring Diagram
- US and Canada UL Recognized
- *Requires optional Wi-Fi Module



OPTIONS

Other Wattages Available

Model	Platform	Pump 1	Pump 2	Blower/Pump 3	Ozone	Circ Pump	Htr Wattage	Spaside Included
CS6P59Y-US	ye-5	1/2 SPD	1/2 SPD	1 SPD	YES	YES	5.5kW	 in.k200 Spaside
CS6P59Y-US-4	ye-5	1/2 SPD	1/2 SPD	1 SPD	YES	YES	5.5kW	 in.k450 Spaside
CS6P59Y-US-8	ye-5	1/2 SPD	1/2 SPD	1 SPD	YES	YES	5.5kW	 in.k8 Spaside

SYSTEM PROGRAMMING CONFIGURATIONS

Program	Pump 1	Pump 2/Blower	Pump 3/Blower	CP	Ozone
1	2 SPD - (A3)	NA	NA	NA	YES - (A4)
2	2 SPD - (A3)	NA	NA	24 HR - (A1)	YES - (A4)
3	2 SPD - (A3)	NA	NA	THERM - (A1)	YES - (A4)
4	2 SPD - (A3)	1 SPD - (A2)	NA	NA	YES - (A4)
5	2 SPD - (A3)	1 SPD - (A2)	NA	24 HR - (A1)	YES - (A4)
6	2 SPD - (A3)	1SPD - (A2)	NA	THERM - (A1)	YES - (A4)
7	2 SPD - (A3)	2 SPD - (A2)	NA	NA	YES - (A1)
8	2 SPD - (A3)	2 SPD - (A2)	NA	24 HR - (A1)	YES - (A1)
9	2 SPD - (A3)	2 SPD - (A2)	NA	THERM - (A1)	YES - (A1)
10	2 SPD - (A3)	1 SPD - (A2)	1 SPD - (A1)	NA	YES - (A4)
11	2 SPD - (A3)	1SPD - (A2)	1 SPD - (A1)	24 HR - (A4)	YES - (A4)
12	2 SPD - (A3)	1SPD - (A2)	1 SPD - (A1)	THERM - (A4)	YES - (A4)
13	2 SPD - (A3)	2 SPD - (A2)	1 SPD - (A1)	NA	YES - (A4)
14	2 SPD - (A3)	2SPD - (A2)	1 SPD - (A1)	24 HR* - (A0)	YES - (A0)
15	1 SPD - (A3)	NA	1 SPD - (A1)	24 HR - (A4)	YES - (A4)
16	1 SPD - (A3)	1 SPD - (A2)	1 SPD - (A1)	24 HR - (A4)	YES - (A4)

IN-TOUCH2 MODULE (OPTIONAL)



*Wi-Fi Module Kit
PT# 34-0216G-K

INSTALLATION KIT (Included)

Kit Includes:

- Spaside Control (See above)
- Spaside Label
- Spaside Adapter Plate
- 48" Component Cords
- 12V Light Assembly



SYSTEM SPECIFICATIONS

ELECTRICAL INPUT SPECIFICATION: SINGLE PHASE, 120/240VAC, 60HZ
ELECTRICAL OUTPUT SPECIFICATION:

CIRCUIT(S)	MAXIMUM AMPS
PUMP(S)	13A
BLOWER	8A
OZONE	2A
CIRCULATION PUMP	5A
LIGHT	1A
HEATER	23A

DIMENSIONS OF CONTROL BOXES & SHIPPING WEIGHT:

CS6P52Y: 22.5"W x 11"H x 7"D 19 LBS

WARRANTY:
2 YEAR LIMITED WARRANTY STANDARD

YE-5 Series with Fixed Heater

STANDARD FEATURES

- HQ YE-5 Platform
- 1.375/5.5kW Fixed Heater Assy
- Wi-Fi Capable*
- Spaside Control (Varies depending on model)
- 12V Light Assembly
- Heater "ON" Indicator Light
- Smart-Freeze Protection
- Pressure Switch Protected
- Installation Kit (see below)
- Detailed Owner's Manual & Wiring Diagram
- US and Canada UL Recognized
- *Requires optional Wi-Fi Module

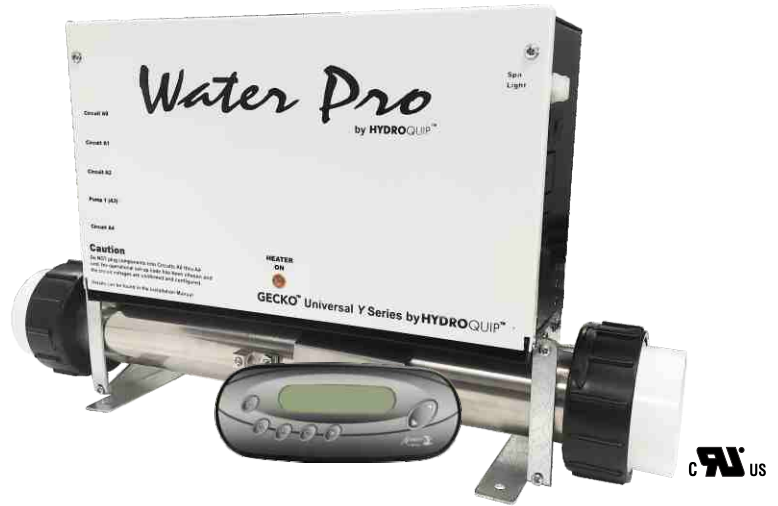

OPTIONS

Other Wattages Available

Model	Platform	Pump 1	Pump 2	Blower/Pump 3	Ozone	Circ Pump	Htr Wattage	Spaside Included
CS6P50Y-US	ye-5	1/2 SPD	1/2 SPD	1 SPD	YES	YES	5.5kW	in.k200 Spaside
CS6P50Y-US-4	ye-5	1/2 SPD	1/2 SPD	1 SPD	YES	YES	5.5kW	in.k450 Spaside
CS6P50Y-US-8	ye-5	1/2 SPD	1/2 SPD	1 SPD	YES	YES	5.5kW	in.k8 Spaside

SYSTEM PROGRAMMING CONFIGURATIONS

Program	Pump 1	Pump 2/Blower	Pump 3/Blower	CP	Ozone
1	2 SPD - (A3)	NA	NA	NA	YES - (A4)
2	2 SPD - (A3)	NA	NA	24 HR - (A1)	YES - (A4)
3	2 SPD - (A3)	NA	NA	THERM - (A1)	YES - (A4)
4	2 SPD - (A3)	1 SPD - (A2)	NA	NA	YES - (A4)
5	2 SPD - (A3)	1 SPD - (A2)	NA	24 HR - (A1)	YES - (A4)
6	2 SPD - (A3)	1SPD - (A2)	NA	THERM - (A1)	YES - (A4)
7	2 SPD - (A3)	2 SPD - (A2)	NA	NA	YES - (A1)
8	2 SPD - (A3)	2 SPD - (A2)	NA	24 HR - (A1)	YES - (A1)
9	2 SPD - (A3)	2 SPD - (A2)	NA	THERM - (A1)	YES - (A1)
10	2 SPD - (A3)	1 SPD - (A2)	1 SPD - (A1)	NA	YES - (A4)
11	2 SPD - (A3)	1SPD - (A2)	1 SPD - (A1)	24 HR - (A4)	YES - (A4)
12	2 SPD - (A3)	1SPD - (A2)	1 SPD - (A1)	THERM - (A4)	YES - (A4)
13	2 SPD - (A3)	2 SPD - (A2)	1 SPD - (A1)	NA	YES - (A4)
14	2 SPD - (A3)	2SPD - (A2)	1 SPD - (A1)	24 HR* - (A0)	YES - (A0)
15	1 SPD - (A3)	NA	1 SPD - (A1)	24 HR - (A4)	YES - (A4)
16	1 SPD - (A3)	1 SPD - (A2)	1 SPD - (A1)	24 HR - (A4)	YES - (A4)



INSTALLATION KIT (Included)

Kit Includes:

- Spaside Control (See above)
- Spaside Label
- Spaside Adapter Plate
- 48" Component Cords
- 12V Light Assembly



SYSTEM SPECIFICATIONS

ELECTRICAL INPUT SPECIFICATION: SINGLE PHASE, 120/240VAC, 60HZ
ELECTRICAL OUTPUT SPECIFICATION:

CIRCUIT(S)	MAXIMUM AMPS
PUMP(S)	13A
BLOWER	8A
OZONE	2A
CIRCULATION PUMP	5A
LIGHT	1A
HEATER	23A

CS9700Y SLIDE Deluxe Series

STANDARD FEATURES

- 1.375/5.5KW, 16.25" SLIDE Heater Assembly
- Wi-Fi Enabled*
- EZ Access Foot Heater
- Spaside Control
- 12V Light Assembly
- All Circuits Convertible to 120 or 240VAC
- Heater "ON" Indicator Light
- Pressure Switch Protection
- Smart-Freeze Protection
- Easy to Install & Service
- Installation Kit (see below)
- Detailed Owners Manual & Wiring Diagram



Includes Spaside

OPTIONS

- Versi-Heat Remote Heater with 60" Cords
- Various Heater Wattages
- Less Heater Model

Model	Platform	Pump 1	Pump 2	Pump 3	Blower	Aux Circuit	Ozone	Circ Pump	12V Light	Spaside Included
CS9709Y-US	ye-7	1 or 2 SPD	1 or 2 SPD	1 SPD	1 SPD	2	YES	YES	1-3 STEP	 in.k8 Spaside

Add (-VH) suffix to Model number for Versi-Heat Series w/ 60" Htr Cord
 Add (-LH) suffix to Model number for Less Heater Series

IN-TOUCH2 MODULE (OPTIONAL)

* Requires Wi-Fi Module Kit PT# 34-0216G-K



INSTALLATION KIT (Included)

Kit Includes:

- Spaside Control
- Spaside Label
- Spaside Adapter Plate
- 48" Component Cords
- 2" Tailpieces w/Gaskets
- 12V Light Assembly



SYSTEM SPECIFICATIONS

ELECTRICAL INPUT SPECIFICATION: SINGLE PHASE, 120/240VAC, 60HZ

ELECTRICAL OUTPUT SPECIFICATION:

CIRCUIT(S)	MAXIMUM AMPS	CIRCUIT(S)	MAXIMUM AMPS
PUMP(S)	13A	CIRC PUMP	5A
BLOWER	8A	LIGHT	1A
OZONE	2A	HEATER	23A

SYSTEM DIMENSIONS: 15"W x 11"H x 4"D
SHIPPING WEIGHT: 14 LBS
PACKAGING / SHIPPING : INDIVIDUAL (HQ STOCK)
 FOB CORONA, CA 92878

2 YEAR LIMITED WARRANTY STANDARD



Air Series by Hydro-Quip



HYDROQUIP[™]
THE **SMART CHOICE**[™]

Made in the USA

CS6000 SLIDE Series

STANDARD FEATURES

- 1.375/5.5KW, 15" SLIDE Heater Assembly
- EZ Access Foot Heater
- Spaside Receptacle
- 12V Light Assembly
- Heater "ON" Indicator Light
- 24hr Timer With Mode Switch
- Full Range Thermostat
- "VDS" Visual Diagnostics
- Easy to Install & Service
- Installation Kit (see below)
- Detailed Owner's Manual & Wiring Diagram
- US and Canada UL Recognized

OPTIONS

- Versi-Heat Remote Heater with 60" Cord
- Spaside Control



Model	Pump 1	Pump 2	Blower	Ozone	Htr Wattage
CS6009-US1	2 SPD	N/A	YES	YES	5.5kW
CS6009-US2	2 SPD	1 SPD	YES	YES	5.5kW
CS6009-S1-3W(240V Only)	2 SPD	1 SPD	YES	YES	5.5kW

Add (-VH) suffix to Model number for Versi-Heat Series w/ 60" Htr Cord

SPASIDE CONTROL OPTIONS



3 Button Analog Spaside Control

Replaced by HQ PT# 34-0039D-S



3 Button Digital Spaside Control

HQ PT# 34-0039D-S



4 Button Analog Spaside Control

Replaced by HQ PT# 34-0037D-S



4 Button Digital Spaside Control

HQ PT# 34-0037D-S

EQUIPMENT SYSTEMS

The Air Series systems are also available as Equipment Systems which would come with a specific pump and blower of your choosing. By adding the special Option Code* to the ES Model number below, you can create your own custom system.

ES Model:	*Option Code	Pump	Voltage	Blower	Voltage	*Option Code	Pump	Voltage	Blower	Voltage
ES6000	-A	1 HP	120	1 HP	120	-E	2 HP	240	1 HP	120
	-B	1 HP	120	N/A	N/A	-F	2 HP	240	N/A	N/A
	-C	1.5 HP	120	1 HP	120	-G	3 HP	240	1 HP	120
	-C5	1.5 HP	240	1 HP	120	-H	3 HP	240	N/A	N/A
	-D	1.5 HP	120	N/A	N/A	-J	4 HP	240	1 HP	120
	-D5	1.5 HP	240	N/A	N/A	-K	4 HP	240	N/A	N/A

All ES Systems include an Installation Kit**, plastic base, mounting hardware, plumbing header(heater to pump) and pump unions.

INSTALLATION KIT (Included)

Kit Includes:

- 48" Component Cords
- Air Transmitters
- Air Tubing
- 2" Tailpieces w/Gaskets



SYSTEM SPECIFICATIONS

ELECTRICAL INPUT SPECIFICATION: SINGLE PHASE, 120/240VAC, 60HZ

ELECTRICAL OUTPUT SPECIFICATION:

CIRCUIT(S)	MAXIMUM AMPS
PUMP(S)	13A
BLOWER	8A
OZONE	2A
HEATER	23A

SYSTEM DIMENSIONS:

SHIPPING WEIGHT:

PACKAGING / SHIPPING :

WARRANTY:

1 YEAR LIMITED WARRANTY STANDARD

15"W x 11"H x 5"D

18 LBS

INDIVIDUAL (HQ STOCK)

FOB CORONA, CA 92878

CS4000 SLIDE Series

STANDARD FEATURES

- 1.375/5.5KW, 15" SLIDE L Shaped Heater Assembly
- EZ Access Foot Heater
- Spaside Receptacle
- 12V Light Assembly
- Heater "ON" Indicator Light
- 24hr Timer With Mode Switch
- Full Range Thermostat
- "VDS" Visual Diagnostics
- Easy to Install & Service
- Installation Kit (see below)
- Detailed Owner's Manual & Wiring Diagram
- US and Canada UL Recognized



OPTIONS

- Versi-Heat Remote Heater with 60" Cord
- Spaside Control



Model	Pump 1	Pump 2	Blower	Ozone	Htr Wattage
CS4009-US1	2 SPD	N/A	YES	YES	5.5kW
CS4009-US2	2 SPD	1 SPD	YES	YES	5.5kW
CS4009-S1-3W(240V Only)	2 SPD	1 SPD	YES	YES	5.5kW

Add (-VH) suffix to Model number for Versi-Heat Series w/ 60" Htr Cord

SPASIDE CONTROL OPTIONS



3 Button Analog Spaside Control
Replaced by HQ PT# 34-0039D-S



3 Button Digital Spaside Control
HQ PT# 34-0039D-S



4 Button Analog Spaside Control
Replaced by HQ PT# 34-0037D-S



4 Button Digital Spaside Control
HQ PT# 34-0037D-S

EQUIPMENT SYSTEMS

The Air Series systems are also available as Equipment Systems which would come with a specific pump and blower of your choosing. By adding the special Option Code* to the ES Model number below, you can create your own custom system.

ES Model:	*Option Code	Pump	Voltage	Blower	Voltage	*Option Code	Pump	Voltage	Blower	Voltage
ES4000	-A	1 HP	120	1 HP	120	-E	2 HP	240	1 HP	120
	-B	1 HP	120	N/A	N/A	-F	2 HP	240	N/A	N/A
	-C	1.5 HP	120	1 HP	120	-G	3 HP	240	1 HP	120
	-C5	1.5 HP	240	1 HP	120	-H	3 HP	240	N/A	N/A
	-D	1.5 HP	120	N/A	N/A	-J	4 HP	240	1 HP	120
	-D5	1.5 HP	240	N/A	N/A	-K	4 HP	240	N/A	N/A

All ES Systems include an Installation Kit**, plastic base, mounting hardware, plumbing header(heater to pump) and pump unions.

INSTALLATION KIT (Included)

Kit Includes:

- 48" Component Cords
- Air Transmitters
- Air Tubing
- 2" Tailpieces w/Gaskets



SYSTEM SPECIFICATIONS

ELECTRICAL INPUT SPECIFICATION: SINGLE PHASE, 120/240VAC, 60HZ

ELECTRICAL OUTPUT SPECIFICATION:

CIRCUIT(S)	MAXIMUM AMPS
PUMP(S)	13A
BLOWER	8A
OZONE	2A
HEATER	23A

SYSTEM DIMENSIONS:

SHIPPING WEIGHT:

PACKAGING / SHIPPING :

WARRANTY:

1 YEAR LIMITED WARRANTY STANDARD

13"W x 9.25"H x 4.5"D

13 LBS

INDIVIDUAL (HQ STOCK)
FOB CORONA, CA 92878

CS7000 Economy Series

STANDARD FEATURES

- Fixed 1.0/4.0kW 13" Heater Assembly
- EZ Access Foot Heater
- Spaside Receptacle
- 120/240V Universal Models
- Heater "ON" Indicator Light
- 24hr Timer with Mode Switch ("T" units)
- Full Range Thermostat
- Lightweight Aluminum Box
- Easy to Install & Service
- Installation Kit (see below)
- Detailed Owner's Manual & Wiring Diagram
- US and Canada UL Recognized

OPTIONS

- 120V/12V Light Kit w/Air Switch & Wall Fitting Option (see below)
- Spaside Control



Model	Voltage	Pump 1	Heater	Blower	Ozone	GFCI Cord
CS7000-A-15A	120	2 SPD	1.0kW	YES	YES	YES
CS7000T-A-15A	120	2 SPD	1.0kW	YES	YES	YES
CS7000-A	120	2 SPD	1.0kW	YES	YES	NO
CS7000T-A	120	2 SPD	1.0kW	YES	YES	NO
CS7000-U	120/240	2 SPD	1.0/4.0kW	YES	YES	NO
CS7000T-U	120/240	2 SPD	1.0/4.0kW	YES	YES	NO

A = 120V only T = with Timer U = Universal

Add (-VH) suffix to Model number for Versi-Heat Series w/ 60" Htr Cord

SPASIDE CONTROL OPTIONS



3 Button Analog Spaside Control

Replaced by HQ PT# 34-0039D-S



3 Button Digital Spaside Control

HQ PT# 34-0039D-S

LIGHT KIT OPTIONS



Light Kit Assembly Options

PT# 37-0029-SM
With Wall Fitting Kit



Wall Fitting Kit

PT# 37-0031-SM
Less Wall Fitting Kit

For a complete list of parts, refer to our Replacement Parts Section in the back of this catalog

INSTALLATION KIT (Included)

Kit Includes:

- 48" Component Cords
- Air Transmitters
- Air Tubing
- 2" Tailpieces w/Gaskets



SYSTEM SPECIFICATIONS

ELECTRICAL INPUT SPECIFICATION: SINGLE PHASE, 120/240VAC, 60HZ

ELECTRICAL OUTPUT SPECIFICATION:

CIRCUIT(S)	MAXIMUM AMPS
PUMP(S)	13A
BLOWER	8A
OZONE	2A
HEATER	23A

SYSTEM DIMENSIONS:

13"W x 9.25"H x 4.5"D

SHIPPING WEIGHT:

13 LBS

PACKAGING / SHIPPING :

INDIVIDUAL (HQ STOCK)
FOB CORONA, CA 92878

WARRANTY:

1 YEAR LIMITED WARRANTY STANDARD



CS800 / CS500 Series

STANDARD FEATURES

- Fixed 1.125/4.5kW 15" Heater Assembly (CS800)
- Fixed 1.125/4.5kW ABS Housing (CS500)
- 120/240V Models
- Heater "ON" Indicator Light
- Operation Mode Switch
- Full Range Thermostat
- Easy to Install & Service
- Installation Kit (see below)
- Detailed Owner's Manual & Wiring Diagram
- US and Canada UL Recognized

OPTIONS

- 120V/12V Light Kit w/Air Switch & Wall Fitting Option (see below)



Model	Voltage	Heater Wattage	Pump Voltage	Blower Circuit	Blower Voltage	GFCI Cord
CS800-A2	120	1.1kW	120V	Yes	120V	Yes
CS800-B2	240	4.5kW	120V	Yes	120V	No
CS800-C2	240	4.5kW	240V	Yes	120V	No

Model	Voltage	Pump 1 (2SPD)	15A GFCI	Blower	Ozone	Timer	Htr Wattage
CS500-A	120V	120V	YES	120V	YES	NO	1.1kW
CS500T-A	120V	120V	YES	120V	YES	YES	1.1kW
CS500-C	240V	120V	N/A	120V	YES	NO	4.5kW
CS500T-C	240V	120V	N/A	120V	YES	YES	4.5kW
CS500T-C9	240V	240V	N/A	120V	YES	YES	4.5kW

A = 120V only T = with Timer

LIGHT KIT OPTIONS

Light Kit Assembly Options

PT# 37-0029-SM With Wall Fitting Kit

PT# 37-0031-SM Less Wall Fitting Kit

For a complete list of parts, refer to our Replacement Parts Section in the back of this catalog

INSTALLATION KIT (Included)

Kit Includes:

- 48" Component Cords
- Air Transmitters
- 10 ft Air Tubing per transmitter
- 2" Tailpieces w/Gaskets (CS800)
- 1.5" Unions w/Gaskets (CS500)
- 15' GFCI Cord (CS800-A2, CS500X-A)



SYSTEM SPECIFICATIONS

ELECTRICAL INPUT SPECIFICATION: SINGLE PHASE, 120/240VAC, 60HZ

ELECTRICAL OUTPUT SPECIFICATION:

CIRCUIT(S)	MAXIMUM AMPS
PUMP(S)	13A
BLOWER	8A
OZONE	2A
HEATER	23A

SYSTEM DIMENSIONS:

CS800	5"H x 15"W x 5"D
CS500	14"H x 6"W x 6"D
CS800-A2	13.5 LBS
CS800-B2/CS800-C2	12 LBS
CS500	16 LBS

SHIPPING WEIGHT:

WARRANTY:

1 YEAR LIMITED WARRANTY STANDARD



Outdoor Series by Hydro-Quip



HYDROQUIP[™]
THE **SMART CHOICE**[™]

Made in the USA

CS8800 Balboa® BP Series

STANDARD FEATURES

- Balboa BP2000 Platform
- M7 Technology Equipped
- Wi-Fi Enabled
- Titanium Element
- TP600 Spaside Control, 7' Cord
- 50' Spaside Extension Cable
- Dual Temperature Ranges
- Factory Installed Ozone w/tubing (Optional)
- Mode Selection
- Reminder Messages
- Freeze Protection
- Outdoor Weather-tight Construction
- Gas Heater Ready
- UL/CUL Listed



Replacement upper control box for ES systems.



Model	Pump1 Circuit	Pump2 Circuit	Pump3** Circuit	Blower Circuit	Ozone Circuit	Heater Wattage	Light Circuit	Spaside Included
CS8800-A	1 or 2 SPD	1 or 2 SPD	READY	1 SPD	YES	11kW	12/120V	 TP-600 Spaside PT# 34-50335-K
CS8800-B	1 or 2 SPD	1 or 2 SPD	READY	1 SPD	YES	5.5kW	12/120V	
CS8800-C	1 or 2 SPD	1 or 2 SPD	READY	1 SPD	YES	GAS READY	12/120V	
CS8803-A*	1 or 2 SPD	1 or 2 SPD	READY	1 SPD	YES	11kW	12/120V	
CS8803-B*	1 or 2 SPD	1 or 2 SPD	READY	1 SPD	YES	5.5kW	12/120V	
CS8803-C*	1 or 2 SPD	1 or 2 SPD	READY	1 SPD	YES	GAS READY	12/120V	

*These models are replacement control boxes for ES Systems that have the heater on the upper backside of the control box and can be mounted on an ES base.

**Pump 3 option requires the use of the TP-800 or TP-900 spaside controls

SPASIDE CONTROL OPTIONS



TP-400T
PT# 34-50260-K
8.3"L x 2.5"H, 7' Cord
1-2 Circuits



TP-800
PT# 34-50261-K
10"L x 3.5"H, 7' Cord
1-4 Circuits
**Required for Pump 3



AX40
PT# 34-52678-K
7.5"L x 2.3"H, 16' Cord
Aux Spaside
3 Circuits



SPATOUCH
PT# 34-50587-K
5.8"L x 4.1"H, 7' Cord
1-4 Circuits
**Required for Pump 3



Spaside Extension Cords

- PT# 30-25662-7 (7', 4Pin) BP, Wi-Fi Module
- PT# 30-25662-25 (25', 4Pin) BP, Wi-Fi Module
- PT# 30-25662-50 (50', 4Pin) BP, Wi-Fi Module
- PT# 30-25662-100 (100', 4Pin) BP, Wi-Fi Module
- PT# 30-11589-25, Aux (25', 6Pin) Aux only
- PT# 30-11589-50, Aux (50', 6Pin) Aux only
- PT# 30-11589-100, Aux (100', 6Pin) Aux only

INSTALLATION KIT (Included)



- Kit Includes:**
- Spaside Control w/ 7' Cord
 - 50' extension
 - Fittings w/Gaskets
 - Detailed Operation/Installation Manual
 - Wiring Diagram

OPTIONAL ACCESSORIES

WI-FI MODULE KIT



- WiFi Module**
PT# 34-51159(15' Cord)
- Use of Wi-Fi requires Wi-Fi Module and downloading the Balboa Worldwide App (bwa®) for your smart device.

SYSTEM SPECIFICATIONS

ELECTRICAL INPUT SPECIFICATION:
SINGLE PHASE, 240VAC, 60HZ

ELECTRICAL OUTPUT SPECIFICATION:	MAX AMPS
CIRCUIT(S)	12A
PUMP(S)	4A
BLOWER	2A
OZONE	1A
LIGHT	23A/46A
HEATER	

SYSTEM DIMENSIONS:
19.25"W x 15.5"H x 6"D

SHIPPING WEIGHT:
32.5 LBS

PACKAGING / SHIPPING :
INDIVIDUAL (HQ STOCK)
FOB CORONA, CA 92878

WARRANTY:
2 YEAR LIMITED
WARRANTY STANDARD

ES8800 Balboa® BP Series

STANDARD FEATURES

- Balboa BP2000 Platform
- M7 Technology Equipped
- Wi-Fi Enabled
- Titanium Element
- 1.5HP, 240V Blower
- TP600 Spaside Control, 7' Cord
- 50' Spaside Extension Cable
- Outdoor Weather-tight Construction
- Dual Temperature Ranges
- Mode Selection
- Reminder Messages
- Freeze Protection
- Gas Heater Ready
- UL/CUL Listed



Pumps Sold Separately
(see below for pump options)



Some Assembly Required

Shown with Self Priming Pump



Shown with Flooded Suction Pump



Model	Pump1 Circuit	Pump2 Circuit	Pump3** Circuit	Blower Included	Ozone Circuit	Heater Wattage	Light Circuit	Spaside Included
ES8800-11	1 or 2 SPD	1 or 2 SPD	READY	1.5HP	YES	11kW	12/120V	 TP-600 Spaside PT# 34-50335-K 1-3 Circuit
ES8800-5.5	1 or 2 SPD	1 or 2 SPD	READY	1.5HP	YES	5.5kW	12/120V	
ES8800-GAS	1 or 2 SPD	1 or 2 SPD	READY	1.5HP	YES	GAS READY	12/120V	
ES8800-11-LB	1 or 2 SPD	1 or 2 SPD	READY	NO	YES	11kW	12/120V	
ES8800-5.5-LB	1 or 2 SPD	1 or 2 SPD	READY	NO	YES	5.5kW	12/120V	
ES8800-GAS-LB	1 or 2 SPD	1 or 2 SPD	READY	NO	YES	GAS READY	12/120V	

**Pump 3 option requires the use of the TP700, TP800 and SpaTouch spaside controls

SPASIDE CONTROL OPTIONS



TP-400T
PT# 34-50260-K
1-2 Circuits



TP-700
PT# 34-57280-K
1-4 Circuits
**Required for Pump 3



TP-800
PT# 34-50261-K
1-4 Circuits
**Required for Pump 3



SPATOUCH2
PT# 34-50587-K
1-4 Circuits
**Required for Pump 3



Spaside Extension Cords
PT# 30-25662-7 (7', 4Pin) Wi-Fi Module also
PT# 30-25662-25 (25', 4Pin) Wi-Fi Module also
PT# 30-25662-50 (50', 4Pin) Wi-Fi Module also
PT# 30-25662-100 (100', 4Pin) Wi-Fi Module also

LX PUMP OPTIONS

Self Priming



11-56SWP200	2.0HP, 2SPD, 230V, 3.0A/8.0A
11-56SWP300	3.0HP, 2SPD, 230V, 3.5A/10A
11-56SWP400	4.0HP, 2SPD, 230V, 4.4A/12A
11-56SWP500	5.0HP, 2SPD, 230V, 5.0A/15A

Flooded Suction



10-48WUA1502	1.5HP, 2 SPD, 230V, 8.0A/2.6A
10-48WUA2002	2.0HP, 2SPD, 230V, 10A/3.0A
10-56WUA300	3.0HP, 2SPD, 230V, 10A/3.5A
10-56WUA400	4.0HP, 2SPD, 230V, 12A/4.4A

All pumps ordered with any ES8800 Equipment System above will include: Unions, a "Pump to Heater" fittings kit and pump cord with conduit.

Installation Kit (Included)



Kit Includes:
Spaside Control w/ 7' Cord
50' extension
Tail Pcs w/Gaskets
Detailed Operation/Installation Manual
Wiring Diagram

Wi-Fi Module Kit(Optional)



WiFi Module
PT# 34-51159-K(15' Cord)
Use of Wi-Fi requires Wi-Fi Module and downloading the Balboa Worldwide App (bwa*) for your smart device.

SYSTEM SPECIFICATIONS

ELECTRICAL INPUT SPECIFICATIONS:
Single Phase, 240VAC, 60HZ

SYSTEM DIMENSIONS:
39"W x 27"H x 18"D

ELECTRICAL OUTPUT SPECIFICATIONS:
Circuits(s) Max Amps

SHIPPING WEIGHT:
54 lbs w/Pump 101 lbs

PUMP(S)	12A
BLOWER	4A
OZONE	2A
LIGHT	1A
HEATER	23A/46A

SHIPPING DIMENSIONS:
System 39"L x 19"W x 14"D
Pump 27.5"x11.5"x15"

WARRANTY:
2 Year Limited Warranty Standard

PACKAGING / SHIPPING:
Individual (HQ Stock)
FOB Corona, CA 92880

CS8900 Gecko Y-7 Series

STANDARD FEATURES

- Gecko Y Series Platform
- Wi-Fi Enabled
- Titanium Element
- in.k5 Spaside Control, 10' Cord
- Flow Switch Protected
- Mode Selection
- Reminder Messages
- Smart Winter Mode
- Outdoor Weather-tight Construction
- Gas Heater Ready
- UL/CUL Listed



Replacement upper control box for ES systems.

Model	Pump1 Circuit	Pump2 Circuit	Pump3** Circuit	Blower Circuit	Ozone Circuit	Heater Wattage	Light Circuit	Spaside Included
CS8900-A	1 or 2 SPD	1 or 2 SPD	READY	1 SPD	YES	11kW	12/120V	 in.k8 Spaside
CS8900-B	1 or 2 SPD	1 or 2 SPD	READY	1 SPD	YES	5.5kW	12/120V	
CS8900-C	1 or 2 SPD	1 or 2 SPD	READY	1 SPD	YES	GAS READY	12/120V	
CS8903-A*	1 or 2 SPD	1 or 2 SPD	READY	1 SPD	YES	11kW	12/120V	
CS8903-B*	1 or 2 SPD	1 or 2 SPD	READY	1 SPD	YES	5.5kW	12/120V	
CS8903-C*	1 or 2 SPD	1 or 2 SPD	READY	1 SPD	YES	GAS READY	12/120V	

*These models are replacement control boxes for ES Systems that have the heater on the upper backside of the control box and can be mounted on an ES base.

SPASIDE CONTROL OPTIONS



in.k300 Spaside
 PT# 34-0242A-K
 6.30"L x 2.25"H, 10' Cord
1-2 Circuits



in.k450 Spaside
 PT# 34-0240A-K
 7"L x 3.25"H, 10' Cord
1-3 Circuit

INSTALLATION KIT (Included)

Kit Includes:

- Spaside Control w/ 10' Cord
- Fittings w/Gaskets
- Detailed Operation/Installation Manual
- Wiring Diagram



SYSTEM SPECIFICATIONS

ELECTRICAL INPUT SPECIFICATION:
 SINGLE PHASE, 240VAC, 60HZ

ELECTRICAL OUTPUT SPECIFICATION:

CIRCUIT(S)	MAX AMPS
PUMP(S)	15A
BLOWER	15A
OZONE	6A
LIGHT	1A
HEATER	23A/46A

SYSTEM DIMENSIONS:
 19.25"W x 15.5"H x 6"D

SHIPPING WEIGHT:
 32.5 LBS

PACKAGING / SHIPPING :
 INDIVIDUAL (HQ STOCK)
 FOB CORONA, CA 92878

WARRANTY:
 2 YEAR LIMITED WARRANTY
 STANDARD

ES8900 Gecko Y-7 Series

STANDARD FEATURES

- Gecko Y Series Platform
- Wi-Fi Enabled
- Titanium Element
- 1.5HP, 240V Blower
- in.k5 Spaside Control, 10' Cord
- Flow Switch Protected
- Mode Selection
- Reminder Messages
- Smart Winter Mode
- Outdoor Weather-tight Construction
- Gas Heater Ready
- UL/CUL Listed



Pumps Sold Separately
(see below for pump options)



Shown with Self Priming Pump



Shown with Flooded Suction Pump



Some Assembly Required

Model	Pump1 Circuit	Pump2 Circuit	Pump3** Circuit	Blower Included	Ozone Circuit	Heater Wattage	Light Circuit	Spaside Included
ES8900-11	1 or 2 SPD	1 or 2 SPD	READY	1.5HP	YES	11kW	12/120V	<p>in.k8 Spaside</p>
ES8900-5.5	1 or 2 SPD	1 or 2 SPD	READY	1.5HP	YES	5.5kW	12/120V	
ES8900-GAS	1 or 2 SPD	1 or 2 SPD	READY	1.5HP	YES	GAS READY	12/120V	
ES8900-11-LB	1 or 2 SPD	1 or 2 SPD	READY	NO	YES	11kW	12/120V	
ES8900-5.5-LB	1 or 2 SPD	1 or 2 SPD	READY	NO	YES	5.5kW	12/120V	
ES8900-GAS-LB	1 or 2 SPD	1 or 2 SPD	READY	NO	YES	GAS READY	12/120V	

SPASIDE CONTROL OPTIONS



in.k300 Spaside
PT# 34-0242A-K
1-2 Circuits



in.k450 Spaside
PT# 34-0240A-K
1-3 Circuit

LX PUMP OPTIONS

Self Priming



- 11-56SWP200 2.0HP, 2SPD, 230V, 3.0A/8.0A
- 11-56SWP300 3.0HP, 2SPD, 230V, 3.5A/10A
- 11-56SWP400 4.0HP, 2SPD, 230V, 4.4A/12A
- 11-56SWP500 5.0HP, 2SPD, 230V, 5.0A/15A

Flooded Suction



- 10-48WUA1502 1.5HP, 2 SPD, 230V, 8.0A/2.6A
- 10-48WUA2002 2.0HP, 2SPD, 230V, 10A/3.0A
- 10-56WUA300 3.0HP, 2SPD, 230V, 10A/3.5A
- 10-56WUA400 4.0HP, 2SPD, 230V, 12A/4.4A

All pumps ordered with any ES8800 Equipment System above will include: Unions, a "Pump to Heater" fittings kit and pump cord with conduit.

Installation Kit (Included)



- Kit Includes:**
- Spaside Control w/ 10' Cord
 - Fittings w/Gaskets
 - Detailed Operation/Installation Manual
 - Wiring Diagram

SYSTEM SPECIFICATIONS

Electrical Input Specifications:
SINGLE PHASE, 240VAC, 60HZ

System Dimensions:
39"W x 27"H x 18"D

Electrical Output Specifications:

CIRCUIT(S)	MAX AMPS
PUMP(S)	15A
BLOWER	15A
OZONE	6A
LIGHT	1A
HEATER	23A/46A

Shipping Weight:
54 lbs w/Pump 101 lbs

Shipping Dimensions:
- System 39"L x 19"W x 14"D

Packaging / Shipping:
Individual (HQ STOCK)
FOB Corona, CA 92878

Warranty:
2 Year Limited Warranty Standard

HeatMax Remote Heater Series

STANDARD FEATURES

- 5.5 or 11KW, "U" Heater Assembly
- 2.25" High Flow U-Shaped Heater Design
- Stainless Steel Heater Housing
- Full Range Thermostat
- High Limit and Pressure Switch Protected
- 2" or 1½" Plumbing Connections
- Weather-Tight Construction
- Heater "ON" Indicator Light
- "Paint-Lock" rust proof enclosure
- Detailed Owner's Manual & Wiring Diagram

OPTIONS

- Various Heater Wattages



The Hydro-Quip HEATMAX series heater is our basic "heater in a box" unit. When all you need is heat, this is the most practical and user friendly unit in the industry. 5.5kW OR 11kW for new and existing applications where a full high flow free standing heater is needed.

Incoloy Model	Voltage	Wattage	Warranty
HEATMAX RHS 5.5*	240	5.5kW	2 YEARS
HEATMAX RHS 11*	240	11kW	2 YEARS
Titanium Model			
HEATMAX-TI 5.5*	240	5.5kW	2 YEARS
HEATMAX-TI 11*	240	11kW	2 YEARS
Salt Safe Model			
HEATMAX-SALT SAFE 5.5	240	5.5kW	2 YEARS
HEATMAX-SALT SAFE 11	240	11kW	2 YEARS

*Units not compatible with salt water systems

INSTALLATION KIT (Included)

Kit Includes:

Fittings w/Gaskets



SPECIFICATIONS

ELECTRICAL INPUT SPECIFICATION: SINGLE PHASE, 240VAC, 50/60HZ

PACKAGING / SHIPPING:

INDIVIDUAL (HQ STOCK)
FOB CORONA, CA 92878

WARRANTY:

2 YEAR LIMITED WARRANTY STANDARD



Blowers & Bath Heaters



HYDROQUIP[™]
THE **SMART** CHOICE[™]

Made in the USA

Universal Silent Air

STANDARD FEATURES

- New Innovative Design
- Quiet Operation
- Compact and Lightweight
- Thermally Protected Motor
- Available In Various Voltages and Hp's
- 42" Amp Adapter Cord
- 6" Universal Cord/Plug
- 1 Speed

OPTIONS

- Various Cord Configurations
- Built in Air Switch
- Built in Heater
- Export models

Now includes, 42" Amp Adapter Cord!



NON HEATED BLOWERS

ORDER CODE	VOLTS	AMPS	WATTAGE	HP	HEATER
AS-610U	120	4.4	600	1.0	N/A
AS-620U	240	2.4	600	1.0	N/A
AS-810U	120	5.8	800	1.5	N/A
AS-820U	240	3.1	800	1.5	N/A

HEATED BLOWERS

ORDER CODE	VOLTS	AMPS	WATTAGE	HP	HEATER
ASH-612U	120	6.1	600	1.0	200W
ASH-622U	240	3.2	600	1.0	200W
ASH-812U	120	7.4	800	1.5	200W
ASH-822U	240	3.9	800	1.5	200W
ASH-616U	120	9.1	600	1.0	600W
ASH-626U	240	4.7	600	1.0	600W
ASH-816U	120	10.5	800	1.5	600W
ASH-826U	240	5.4	800	1.5	600W

CORD OPTIONS



30-1200-L48
Molded 48"



30-1057-36
Nema 36"



30-1302-48
XM/XE 120V 48"



30-1302A-48
XM/XE 240V 48"



30-1200-A48
4 Pin Amp 48"

OPTIONAL ACCESSORIES



Ozone Manifold Kit
42-0116-K

BLOWER SPECIFICATIONS

ELECTRICAL INPUT SPECIFICATION: SINGLE PHASE, 120/240VAC, 50/60HZ

BLOWER DIMENSIONS: 8"W x 5"H x 9.25"L

SHIPPING WEIGHT: 4 LBS

WARRANTY:
1 YEAR LIMITED WARRANTY STANDARD

PACKAGING / SHIPPING OPTIONS:
INDIVIDUAL (HQ STOCK)
BULK PACK 12 INDIVIDUALLY BOXED OR LOOSE IN
MASTER CARTON
FOB CORONA, CA 92878

Pure Heat Tee Style

STANDARD FEATURES

- Low Profile Design
- Versatile Compact Sizes 7" or 5.5"
- Automatic Smart Thermostat
- Intelligent High-Limit
- Pressure Switch Activated
- Heater "On" Indicator Light
- Stainless Steel Heater Housing
- Installation Kit Included (see below)
- Detailed Owner's Manual & Installation Guide



OPTIONS

- Available as a 5.5" Tee Style
- 240 Volt, Export & Domestic

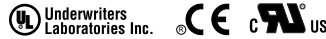

MODEL	PSI**	Volts	Wattage	Size	Length (Included)	Fittings
PH100-65UP*	YES	120	650	1.5"	7"	1.5" & 1" SOC, 1" SPIG
PH100-10UP	YES	120	1000	1.5"	7"	1.5" & 1" SOC, 1" SPIG
PH100-15UP	YES	120	1500	1.5"	7"	1.5" & 1" SOC, 1" SPIG
PH202-20UP	YES	240	2000	1.5"	7"	1.5" & 1" SOC, 1" SPIG
PH100-10UP-S	YES	120	1000	1.5"	5.5"	1.5" & 1" SOC, 1" SPIG
PH100-15UP-S	YES	120	1500	1.5"	5.5"	1.5" & 1" SOC, 1" SPIG
PH202-20UP-S	YES	240	2000	1.5"	5.5"	1.5" & 1" SOC, 1" SPIG

**PSI = Pressure Switched

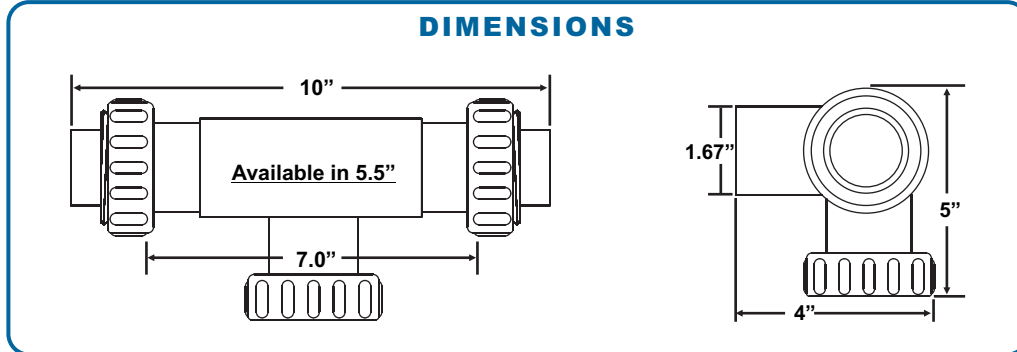

New piggy back plug is standard on all PH100-65UP 650W heaters.

*Provides an additional 120V plug-in outlet for up to a 1.5HP (9.5 Amp) bath pump. 650W, 120V heater only

Also Available in Plus Ozone Option (-03 suffix)
Refer to price list for the complete list of model numbers.

INSTALLATION KIT (Included)



HEATER SPECIFICATIONS

ELECTRICAL INPUT SPECIFICATION: SINGLE PHASE, 120VAC, 50/60HZ

ELECTRICAL OUTPUT SPECIFICATION:

VOLTS	WATTAGE	MAXIMUM AMPS
120	650	5.3A
120	1000	8.3A
120	1500	12.5A
240	2000	8.3A

HEATER DIMENSIONS:

Standard 7"W x 5"H x 4"D
Short 5.5"W x 5"H x 4"D

SHIPPING WEIGHT:

1.75 LBS

PACKAGING / SHIPPING:

INDIVIDUAL (HQ STOCK)
FOB CORONA, CA 92878

WARRANTY:

2 YEAR LIMITED WARRANTY STANDARD

Pure Heat Inline Style

STANDARD FEATURES

- Versatile Compact Sizes 7" or 5.5"
- Automatic Smart Thermostat
- Intelligent High-Limit
- Pressure & Vacuum Switch Activated
- Heater "On" Indicator Light
- Stainless Steel Heater Housing
- Installation Kit Included (see below)
- Detailed Owner's Manual & Installation Guide

OPTIONS

- Available as a 5.5" Inline Style
- 240 Volt, Export & Domestic



MODEL	PSI/VAC**	Volts	Wattage	Size	Length	Fittings (Included)
PH101-65UP*	PSI	120	650	1.5"	7"	1.5" & 1" SOC, 1" SPIG
PH101-10UP	PSI	120	1000	1.5"	7"	1.5" & 1" SOC, 1" SPIG
PH101-15UP	PSI	120	1500	1.5"	7"	1.5" & 1" SOC, 1" SPIG
PH203-20UP	PSI	240	2000	1.5"	7"	1.5" & 1" SOC, 1" SPIG
PH301-15UP	PSI	120	1500	2"	7"	2" SOC & 2" SPIG
PH301-20UP	PSI	240	2000	2"	7"	2" SOC & 2" SPIG
PH101-10UV	VAC	120	1000	1.5"	7"	1.5" & 1" SOC
PH101-15UV	VAC	120	1500	1.5"	7"	1.5" & 1" SOC
PH203-20UV	VAC	240	2000	1.5"	7"	1.5" & 1" SOC, 1" SPIG
PH301-15UV	VAC	120	1500	2"	7"	2" SOC & 2" SPIG
PH301-20UV	VAC	240	2000	2"	7"	2" SOC & 2" SPIG
PH101-15UP-S	PSI	120	1500	1.5"	5.5"	1.5" & 1" SOC, 1" SPIG
PH101-15UV-S	VAC	120	1500	1.5"	5.5"	1.5" & 1" SOC

**PSI = Pressure Switched VAC = Vacuum Switched

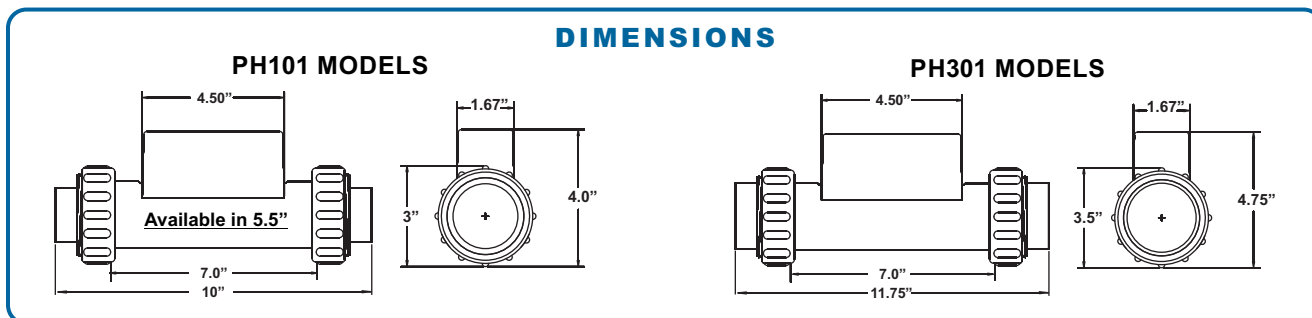

New piggy back plug is standard on all PH101-65UP 650W heaters.

*Provides an additional 120V plug-in outlet for up to a 1.5HP (9.5 Amp) bath pump. 650W, 120V heater only

Also Available in Plus Ozone Option (-03 suffix)
Refer to price list for the complete list of model numbers.

INSTALLATION KIT (Included)



*Not included with "PH101" vacuum switched heaters

HEATER SPECIFICATIONS

ELECTRICAL INPUT SPECIFICATION: SINGLE PHASE, 120VAC, 50/60HZ

ELECTRICAL OUTPUT SPECIFICATION:		
VOLTS	WATTAGE	MAXIMUM AMPS
120	650	5.3A
120	1000	8.3A
120	1500	12.5A
240	2000	8.3A

HEATER DIMENSIONS:

PH101	7"W x 4"H x 3"D
PH301	7"W x 4.75"H x 3.5"D
(-S)	5.5" x 4"H x 3"D

SHIPPING WEIGHT: 1.5 LBS
PACKAGING / SHIPPING: INDIVIDUAL (HQ STOCK)
FOB CORONA, CA 92878

WARRANTY: 2 YEAR LIMITED WARRANTY STANDARD

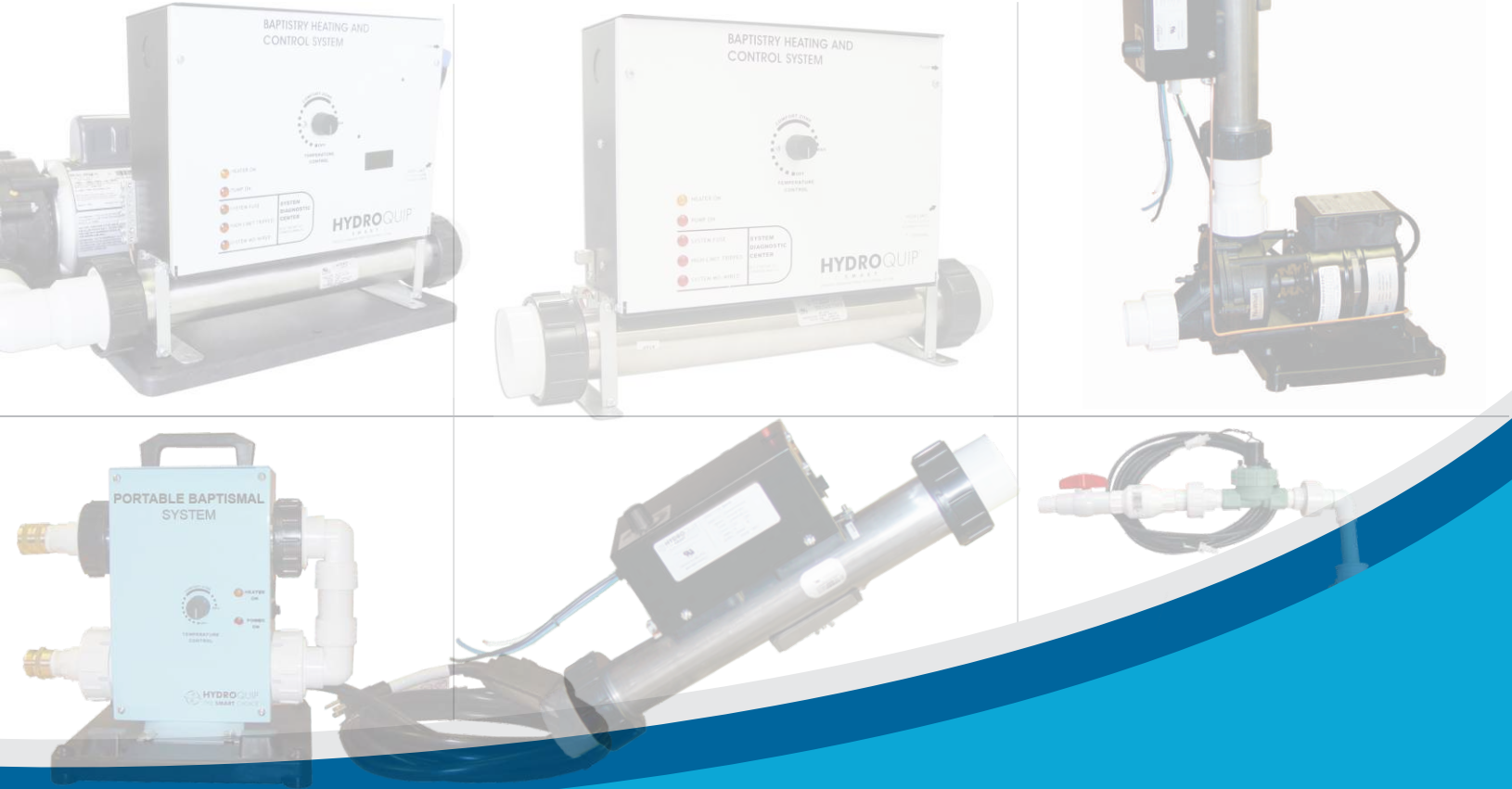

Baptismal Systems

Hydro-Quip has been producing reliable Baptismal Systems for over 30 years and we understand the importance of safety and reliability. That's why we take pride in manufacturing an efficient and quality system that churches can depend on. We have various configurations to choose from for all your Baptismal needs.



HYDROQUIP[™]
THE **SMART CHOICE**[™]

Made in the USA

BES6000 / 6000T Series



BES6000 (5.5kW) Series Shown



Some Assembly Required

BES6005T (11kW) Series Shown

BAPTISMAL EQUIPMENT SYSTEMS BY MODEL

MODEL	Voltage	Pump Voltage	Pump Speed	Htr Wattage	7-Day Timer
BES6000	240	120V	1	5.5KW	NO
BES6005	240	120V	1	11KW	NO
BES6000T	240	120V	1	5.5KW	YES
BES6005T	240	120V	1	11KW	YES

FEATURES & OPTIONS

Standard:

- 5.5 or 11KW Heater in 304SS Housing
- Full Range Thermostat
- High Limit Protected
- Pressure Switch Activated
- Base Provided
- System Diagnostics Indicators
- Heater "ON" Indicator Light
- Detailed Installation Manual
- Detailed Owner's Manual
- Detailed Wiring Diagram

Available Options:

- 7-Day Timer (BES6000/5T models only)
- BES6000/5T SERIES WARNING:**
SYSTEMS WITH TIMERS SHOULD NOT TO BE USED ON FILL & DRAIN BAPTISMALS
- Auto-Fill Kit
- Water Level Kit
- Drain Kit
- Step Lighting
- Cartridge Filter
- UV Sanitizer

Accessories:

(See Page 7.3 For Details)

- Auto-Fill Valve: (PT# 48-0143-K)
- Auto-Drain Kit: (PT# 48-0141-K)
- System Interface Module:
(PT# 48-0042-K)
- Water Level Sensors:
(Float PT# 48-0141C-K)
(Pressure PT# 48-0148-K)
- Plus Ozone Manifold Kit: (49-0420A-K)

INSTALLATION KIT INCLUDED



ELECTRICAL SPECIFICATIONS:

SINGLE PHASE
4-WIRE SERVICE
50/60HZ

MINIMUM SPACE REQUIRED:

14"H X 26"W X 16"D

TOTAL AMP DRAW:

(CIRCUIT BREAKER SIZE)

BES6000 & BES6000T	36A	50
BES6005 & BES6005T	59A	70

DIMENSIONS:

13"H X 27"W X 15"D (5.5KW MODELS) 13"H X 29"W X 15"D (11KW MODELS)

SHIPPING WEIGHT:

BES6000	44 LBS.	BES6000T	44 LBS.
BES6005	49 LBS.	BES6005T	49 LBS.

WARRANTY:

1 YEAR LIMITED WARRANTY

BCS6000 / 6000T Series



BCS6000 (5.5kW) Series Shown

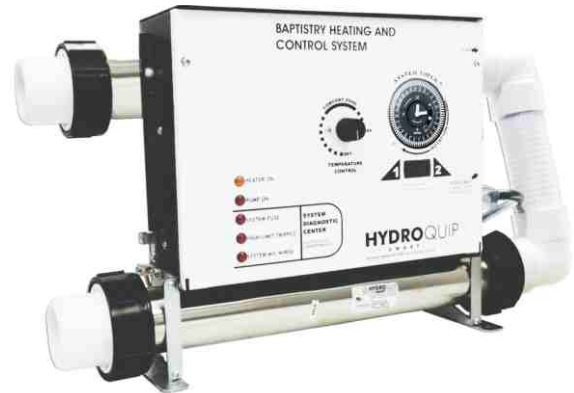

BCS6005T (11kW) Series Shown

BAPTISMAL CONTROL SYSTEMS BY MODEL

MODEL	Voltage	Htr Wattage	7-Day Timer
BCS6000-U	120/208/240	5.5KW	NO
BCS6005-U	208/240	11KW	NO
BCS6000T-U	120/208/240	5.5KW	YES
BCS6005T-U	208/240	11KW	YES

FEATURES & OPTIONS

Standard:

- 5.5 or 11KW Heater in 304SS Housing
- Full Range Thermostat
- High Limit Protected
- Pressure Switch Activated
- 7-Day Timer (BCS6000/5T models only)
- BCS6000/5T SERIES WARNING:**
SYSTEMS WITH TIMERS SHOULD NOT TO BE USED ON FILL & DRAIN BAPTISMALS
- System Diagnostics Indicators
- Heater "ON" Indicator Light
- Detailed Installation Manual
- Detailed Owner's Manual
- Detailed Wiring Diagram

Available Options:

- Auto-Fill Kit
- Water Level Kit
- Drain Kit
- Step Lighting
- Cartridge Filter
- UV Sanitizer

Accessories:

(See Page 7.3 For Details)

- Auto-Fill Valve: (PT# 48-0143-K)
- Auto-Drain Kit: (PT# 48-0141-K)
- System Interface Module: (PT# 48-0042-K)
- Water Level Sensors: (Float PT# 48-0141C-K) (Pressure PT# 48-0148-K)
- Plus Ozone Manifold Kit: (49-0420A-K)

INSTALLATION KIT INCLUDED



**11kW systems only

ELECTRICAL SPECIFICATIONS:

- SINGLE PHASE
- 4-WIRE SERVICE
- 50/60HZ

MINIMUM SPACE REQUIRED:

15"H X 18"W X 6"D

TOTAL AMP DRAW:

- BCS6000 23A
- BCS6005 46A
- BCS6000T 23A
- BCS6005T 46A

DIMENSIONS:

- BCS6000 15"W X 12"H X 4"D
- BCS6005 17"W X 12"H X 4"D
- BCS6000T 15"W X 12"H X 4"D
- BCS6005T 17"W X 12"H X 4"D

SHIPPING WEIGHT:

BCS6000 SERIES APPROX 18 LBS.

WARRANTY:

1 YEAR LIMITED WARRANTY

BES11-55 Series

STANDARD FEATURES

- Full Range Thermostat
- High Limit Protected
- Pressure Switch Activated
- Pump Air switch
- Bonding Lug & Wire
- Heater Indicator Light
- Base
- 15A GFCI Cord (BES-15 Only)
- Installation Kit (see below)
- Detailed Owner's Manual & Wiring Diagram

BAPTISMAL EQUIPMENT SYSTEMS BY MODEL

MODEL	Voltage	Htr Wattage	Pump
BES-15	120	1.375KW	120
BES-55	120/208/240*	5.5KW	120
BES-55-3W	240**	5.5KW	240
BES-11	208/240*	11KW	120
BES-11-3W	240**	11KW	240



BES-55 SYSTEM

The BES-55 Series is our newest Baptismal Equipment System. It is a vertically mounted circulation style baptistry heater system. Simple, compact design for easy installation and it's a great replacement for all existing vertical circulation style systems. HydroQuip has been producing reliable Spa & Baptismal Systems for over 30 years and we understand the importance of safety and reliability. That's why we take pride in manufacturing an efficient and quality system that churches can depend on. We have various configurations to choose from for all of your Baptismal needs.

From the ease of installation, to the efficiency of our products and exclusive troubleshooting features, your customers will be glad you made the "Smart Choice" in choosing equipment produced by HydroQuip, the industry's oldest and most trusted manufacturer.



INSTALLATION KIT INCLUDED

ELECTRICAL SPECIFICATIONS:

SINGLE PHASE
50/60HZ
*4-Wire
**3-Wire

MINIMUM SPACE REQUIRED:

36"H X 16"W X 10"D

TOTAL AMP DRAW:

BES-15	18A
BES-55	30A
BES-11	52A

DIMENSIONS:

BES-15	29"H X 15"W X 9"D
BES-55	29"H X 15"W X 9"D
BES-11	35.25"H X 15"W X 9"D

SHIPPING WEIGHT:

BES-15	23 LBS.
BES-55	23 LBS.
BES-11	25 LBS.

WARRANTY:

1 YEAR LIMITED WARRANTY

BCS11-55 Series

STANDARD FEATURES

13" & 15", 5.5kw Heater in 304SS Housing
 Full Range Thermostat
 High Limit Protected
 Pressure Switch Activated
 Installation Kit (see below)
 Detailed Owner's Manual & Wiring Diagram

BAPTISMAL EQUIPMENT SYSTEMS BY MODEL

MODEL	Voltage	Htr Wattage
BCS-15	120	1.375KW (13" HEATER)
BCS-55-3W(15")	240	5.5KW(15" HEATER)
BCS-55-3W	240*	5.5KW(13" HEATER)
BCS-55 (120V pump)**	240*	5.5KW(13" HEATER)
BCS-11-3W	240*	11KW (19" HEATER)

**with 120V Pump Receptacle



The BES-55 Series is our newest Baptismal Equipment System. It is a vertically mounted circulation style baptistry heater system. Simple, compact design for easy installation and it's a great replacement for all existing vertical circulation style systems. HydroQuip has been producing reliable Spa & Baptismal Systems for over 30 years and we understand the importance of safety and reliability. That's why we take pride in manufacturing an efficient and quality system that churches can depend on. We have various configurations to choose from for all of your Baptismal needs.

From the ease of installation, to the efficiency of our products and exclusive troubleshooting features, your customers will be glad you made the "Smart Choice" in choosing equipment produced by HydroQuip, the industry's oldest and most trusted manufacturer.

INSTALLATION KIT INCLUDED



ELECTRICAL SPECIFICATIONS:

SINGLE PHASE
50/60HZ
*3-WIRE SERVICE
MINIMUM SPACE REQUIRED:
26"H X 7"W X 6"D

TOTAL AMP DRAW:

BCS-15	12.5A
BCS-55	23A
BCS-11	46A

DIMENSIONS:

BCS-15	13"H X 6.5"W X 5.5"D
BCS-55	13"H X 6.5"W X 5.5"D
BCS-11	19.25"H X 6.5"W X 5.5"D

SHIPPING WEIGHT:

BCS-15	11 LBS.
BCS-55	11 LBS.
BCS-11	13 LBS.

WARRANTY:

1 YEAR LIMITED WARRANTY



34-0038D25-D

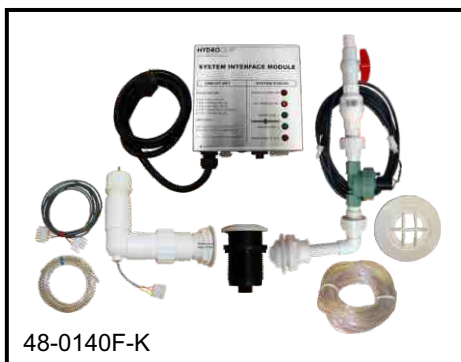

48-0140F-K



48-0140P-K



48-0141-K



48-0141C-K



48-0042-K



48-0143-K



48-0148-K



49-0420A-K
49-0421-K

PART NUMBER

DESCRIPTION

34-0038D25-D	BES Remote Control Kit
48-0140F-K	BES Fill Kit, w/Float Water Level
48-0140P-K	BES Fill Kit, w/Pressure Switch Water Level
48-0141-K	BES Auto Drain Kit
48-0141C-K	Water Level Assy, w/Float
48-0042-K	System Interface Module
48-0143-K	Fill Valve Assy
48-0148-K	Water Level Assy, w/Pressure Switch
49-0420A-K	Ozone Injector Manifold Assembly, 1.5"
49-0421-K	Ozone Injector Manifold Assembly, 2"

PBES6000 Portable Series

STANDARD FEATURES

- 1.0kw or 4.0kw Heater in 304SS Housing
- 1/6HP, 120V Pump
- Full Range Thermostat
- High Limit Protected
- Pressure Switch Activated
- Base Mounted
- Installation Kit (see below)
- Detailed Owner's Manual & Wiring Diagram



BAPTISMAL EQUIPMENT SYSTEMS BY MODEL

MODEL	Pump Voltage	Pump Voltage	Pump HP	Speed	Htr Wattage
PBES6010	120	120V	1/6	1	1.0KW
PBES6040	240*	120V	1/6	1	4.0KW

The PBES6000 Series is our newest in Portable Baptismal Heating Systems. The PBES is made for portable or permanent applications, its compact and safe design make it one of the best systems for the ever popular portable style baptistry. HydroQuip has been producing reliable Spa & Baptismal Systems for over 30 years and we understand the importance of safety and reliability. That's why we take pride in manufacturing an efficient and quality system that churches can depend on. We have various configurations to choose from for all of your Baptismal needs.

From the ease of installation, to the efficiency of our products and exclusive troubleshooting features, your customers will be glad you made the "Smart Choice" and chose equipment produced by HydroQuip, the industry's oldest and most trusted manufacturer.

INSTALLATION KIT INCLUDED



SIDE VIEW

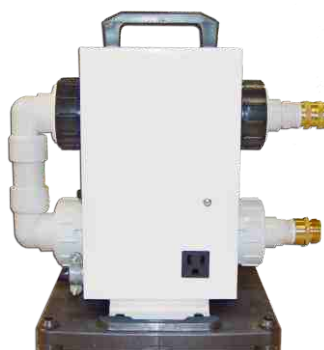

BACK VIEW

ELECTRICAL SPECIFICATIONS:

SINGLE PHASE
*4-WIRE SERVICE
50/60HZ

MINIMUM SPACE REQUIRED:

15"H X 33"W X 17"D

TOTAL AMP DRAW:

SIZE

PBES6010
PBES6040

12.5A
20A

CIRCUIT BREAKER

15
30

DIMENSIONS:

12.5"H X 13"W X 9"D (ALL SYSTEMS)

SHIPPING WEIGHT:

PBES6010 21 LBS.
PBES6040 25 LBS.

WARRANTY:

1 YEAR LIMITED WARRANTY

Immersion Heater

STANDARD FEATURES

- 240V, 6KW / 120V, 1.5KW 316L Stainless Element
- Heater Water Level Safety Float (optional)
- GFCI Power Cord (optional)
- Power Cord w/30A Plug (optional)
- Adjustable Thermostat with "OFF" Position
- Manual Reset Hi-Limit
- Stainless Steel Adjustable Mounting Brackets
- Heater "On" Indicator Light
- Hi-Limit "Tripped" Indicator Light
- Top Mounted Handle
- Operation Manual
- Built to UL Standards



The Safest Baptistry Immersion Heater on the market today!

Model Number	kW	Voltage	GFCI Cord	Cord w/30A Plug	Float
BIS-15-120-GF	1.5	120V	YES	N/A	YES
BIS-15-120-G	1.5	120V	YES	N/A	NO
BIS-60-240-GF	6.0	240V	YES	NO	YES
BIS-60-240-B	6.0	240V	NO	NO	NO
BIS-60-240-FP	6.0	240V	NO	YES	YES
BIS-60-240-G	6.0	240V	YES	NO	NO
BIS-60-240-P	6.0	240V	NO	YES	NO

Cross Reference:

120V Models Replace: IM120, IM120GFI, 6HI-HL-120, CR-IMER, IMER120V, SRA-6041, TAT40013

240V Models Replace: IM240, IM240GFI, SS-6-42HL, 6HI-HL-240, CR-IMER, IME240, IMER240V, 6HI/HL, EXHEAT-PIH, SRC-6041, TLC-260A-036, KTLC-260A-036, TAT40017

APPROVAL LISTINGS:

Built to UL Standards

ELECTRICAL SPECIFICATIONS:

MODEL:	BIS-60-240	BIS-15-120
Voltage:	208-240V(1-phase)	110-120V
Supply:	3-Wire(no neutral)	3-Wire
Plug Type:	Nema 6-30P	Nema 5-15
Amps:	30A @ 240V	15A @ 120V

DIMENSIONS:

46"H x 18"W

SHIPPING DIMENSIONS:

46" X 19" X 3"

SHIPPING WEIGHT:

8.5lbs

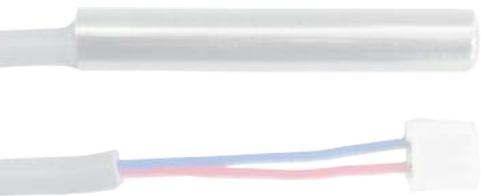
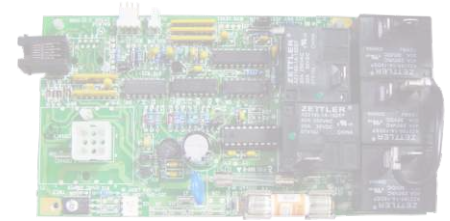

Parts Parts Parts

HydroQuip now offers more spa parts than ever before. Original and generic replacement parts for use with many control system repairs ...



HYDROQUIP[™]
THE **SMART** CHOICE[™]

Made in the USA



PART NUMBER	DESCRIPTION
33-0010-R8-K	Replaced with PT# 33-0025A-K
33-0010-R1-5	Obsolete, Replace PT# 48-0101
33-0012-K	Obsolete - Replace Control System with CS6209Y-US
33-0014A-R8-K	Obsolete - Replace Control System with CS7109B-US
33-0018-R6	Obsolete, Replaced with PT# 48-0101
33-0024-K	ECO-2, 120V (4200, 6200, 9200 series)
33-0024A-K	Obsolete - Contact Factory
33-0024B-K	ECO-3, 120V (4230, 6230, 9230 series)
33-0024C-K	Obsolete - Contact Factory
33-0024D-K	ECO-2+2 120V (4220, 6220, 9220 series)
33-0024E-K	Stand./SSPA 120V (4330, 6330, 9330 series)
33-0024F-K	Obsolete - Contact Factory
33-0025A-K	MP, Univ, 10-Key (9700 series)
33-0027-K	MP, Outdoor 8-Key (8000 series)
48-0101	Kit, MSPA to MP Conversion (replaces 33-0018-RX, 33-0010-R5 & prior)
33-0041A-K	Y Series, ye-7, Expander
33-0045A-K	Y Series, yt-5, Main

EEPROMs

Gecko EEPROMs for 6200, 6220, 6230 & 6330 Series

37-0050	EEPROM, SSPA, 6200 Series
37-0050A	EEPROM, SSPA, 6220 Series
37-0050A	EEPROM, SSPA, 6230 Series
37-0050A	EEPROM, SSPA, 6330 Series

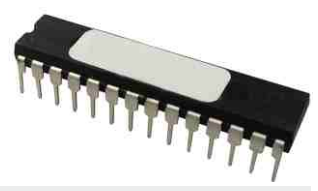

*PC Boards appear physically identical. Only difference is software and/or transformer.

** Sensors available in various sizes & lengths, please see page 8.20



<i>PART#</i>	<i>DESCRIPTION</i>	<i>PART#</i>	<i>DESCRIPTION</i>
33-51056-K	PCB, Lite Leader	33-55299-K	PCB, VS520SZ-3W, Serial
33-53834-K	PCB, EL2000	33-55602-K	PCB, VS520Z, Duplex
33-53858-K	PCB, EL8000, M3R1E	33-55840-K	PCB, VS513Z, Duplex
33-54115-K	PCB, Lite Leader	33-56297-K	PCB, VS100, 120V
33-54357-K	PCB, VS501Z, Duplex	33-56299-K	PCB, VS100, 240V
33-54369-K	PCB, VS500Z, Duplex	33-56380-K	PCB, BP2000-M7
33-54372-K	PCB, VS510SZ, Serial	33-56483-K	Replaced with 33-56965-K
33-54383-K	PCB, VS511Z, Duplex	33-56488-K	Replaced with 33-59375-K
33-54385-K	PCB, VS511SZ, Serial	33-56585-K	Replaced with 33-56961-K
33-54446-K	PCB, Lite Leader, Icon 15	33-56944-K	Replaced with 33-59375-K
33-54604-K	PCB, VS300Z, Duplex	33-56961-K	Replaced with 33-59375-K
33-54638-K	PCB, VS504SZ	33-56965-K	PCB, BP501, G2
33-54646-K	Replaced with 33-54604-K	33-59157-K	PCB, BP2000-M8
33-55151-K	PCB, VS520SZ, Serial	33-59375-K	PCB, BP501U, HQ Universal Kit
33-55152-K	PCB, VS520DZ, Deluxe		

Expanders

Balboa® Series Expander Boards



<i>PART#</i>	<i>DESCRIPTION</i>	<i>PART#</i>	<i>DESCRIPTION</i>
33-53426-K	VS/EL Expander, 2 Rec. 1 Relay	33-55137-K	VS/EL Expander, 2 Relays w/Fuse
33-53544-K	VS/EL Expander, No Fuse	30-0103-K	Expander "Y" Harnes, 25801
33-53681-K	VS/EL Expander, 30A Fuse		

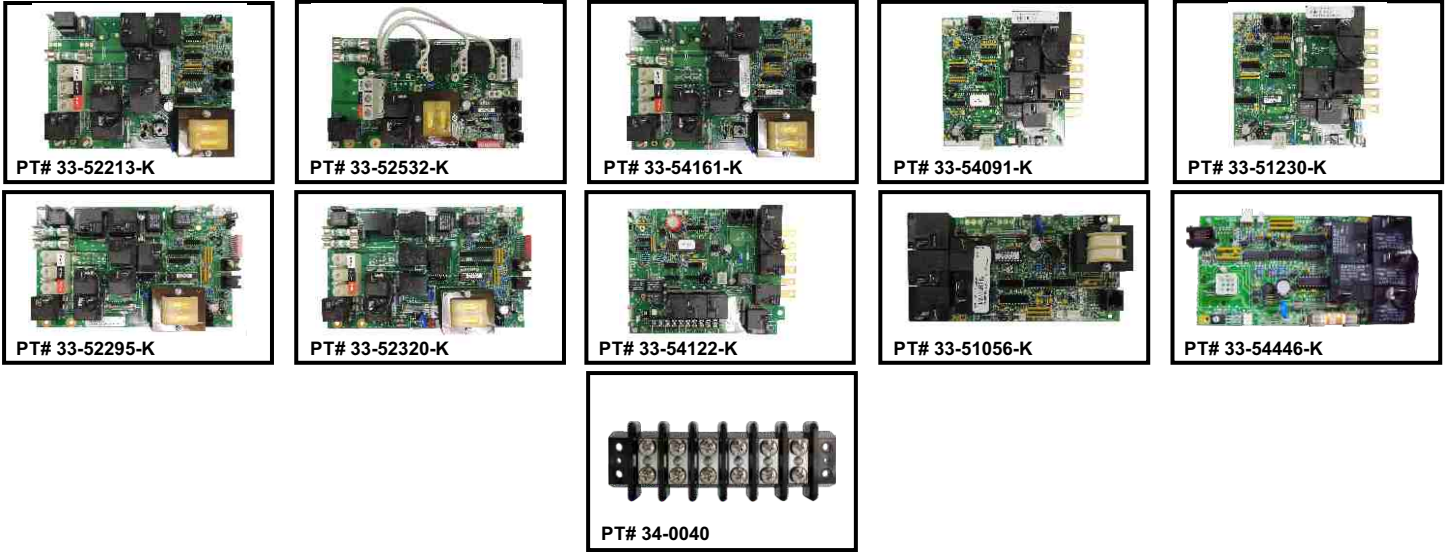

PART#	DESCRIPTION
33-52213-K	Balboa®, Jacuzzi Whirlpool Value System, BWG# 52213, Chip# R576R1D
33-52532-K	Balboa®, SUV, M7, BWG# 52532-02, Chip# SUVR1B
33-54161-K	Balboa®, Value Digital, BWG# 54161, Chip# VALUER1D
33-54091-K	Balboa®, Super Duplex Digital, M1 Systems, BWG# 54091, Chip# M1R1B
33-51230-K	Balboa®, Duplex Analog, BWG# 51230, Chip# DUPLEXR1A
33-52295-K	Balboa®, 2000LE Digital, BWG# 52295-01, Chip# 2000LER1E
33-52320-K	Balboa®, 2000M7, Serial Standard LE, BWG# 52320-01, Chip# 2000M7R1B
33-54122-K	Balboa®, Millennium Standard/Deluxe, BWG# 54122, Chip# M2/M3R1D
33-51056-K	PCB, Balboa®, Lite Digital, BWG# 51056, Chip# WHRLPLR1A
33-54446-K	PCB, Balboa®, Lite Leader, ICON15, BWG# 54446, Chip#ICON15R2B
34-0040	Terminal Strip, Balboa, M1/M3, 6 POS

Contact HydroQuip for information on which sensors and spasides are compatible.

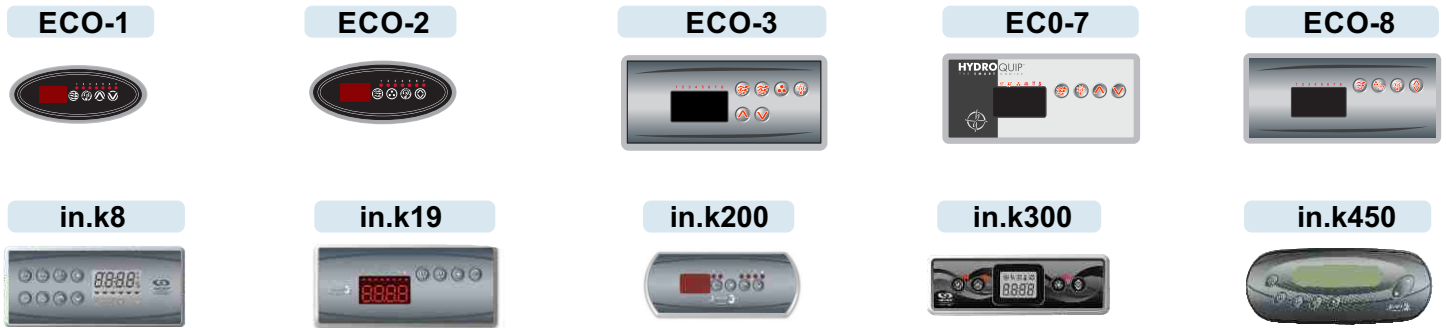

PT #	DESCRIPTION	PT #	DESCRIPTION
ECO-1/2 Spaside Series, LED, 4.5" x 2"		For Gecko S-Class Series by HQ	
34-0193-K	ECO-1, w/80-0201, P/L/W/C	34-0193-U	ECO-1, NO Label, 4.5"x2"
34-0200-K	ECO-2, w/80-0202, P/B/L/T	34-0200-K	ECO-2, LED, w/80-0202, P/B/L/T, 4.5"x2"
ECO-3 Spaside Series, LED, 7" x 3.25"		For Gecko S-Class Series by HQ	
34-0197-K	ECO-3, w/80-0203, P/P/B/L/W/C	34-0197-U	ECO-3, NO Label
34-0197-25-K	ECO-3, w/80-0203, P/P/B/L/W/C, 25' Cord		
ECO-7/8 Spaside Series, LED, 7" x 3.25"		For Gecko S-Class Series by HQ	
34-0198-K	ECO-7, w/80-0205, P/L/W/C	34-0198-U	ECO-7/8, NO Label
34-0198A-K	ECO-8, w/80-0204, P/B/L/T		
in.k8 Spaside Series, LCD, 7" x 3.25"		For Gecko Y Series Systems by HQ	
34-0250-K	in.k8, w/80-0250, P/P/B/L/M/PR/W/C	34-0250-K	in.k8, NO Label
in.k19 Spaside Series, LED, 7" x 3.25"		For Gecko Y Series Systems by HQ	
34-0236-K	in.k19, w/80-0236, P/L/W/C	34-0236-U	in.k19, NO Label, 1 Output
34-0236A-K	in.k19, w/80-0236A, P/A/L/T	34-0236A-U	in.k19, NO Label, 2 Output
in.k200 Spaside Series, LED, 4.75" x 2"		For Gecko Y Series Systems by HQ	
34-0241-K	in.k200, w/80-0241, P/L/W/C	34-0241-U	in.k200, NO Label, 1 Output
34-0241A-K	in.k200, w/80-0241A, P/P/L/T	34-0241A-U	in.k200, NO Label, 2 Output
in.k300 Spaside Series, LED, 6.25" x 2.25"		For Gecko Y Series Systems by HQ	
34-0242-K	in.k300, w/80-0242, P/L/W/C	34-0242-U	in.k300, NO Label, 1 Output
34-0242A-K	in.k300, w/80-0242A, P/P/L/T	34-0242A-U	in.k300, NO Label, 2 Output
in.k450 Spaside Series, LED, 6.25" x 2.25"		For Gecko Y Series Systems by HQ	
34-0240-K	in.k450, w/80-0240, O/P/P/L/W/C	34-0240-U	in.k450, NO Label, 2 Output
34-0240A-K	in.k450, w/80-0240A, O/P/P/P/L/W/C	34-0240A-U	in.k450, NO Label, 3 Output



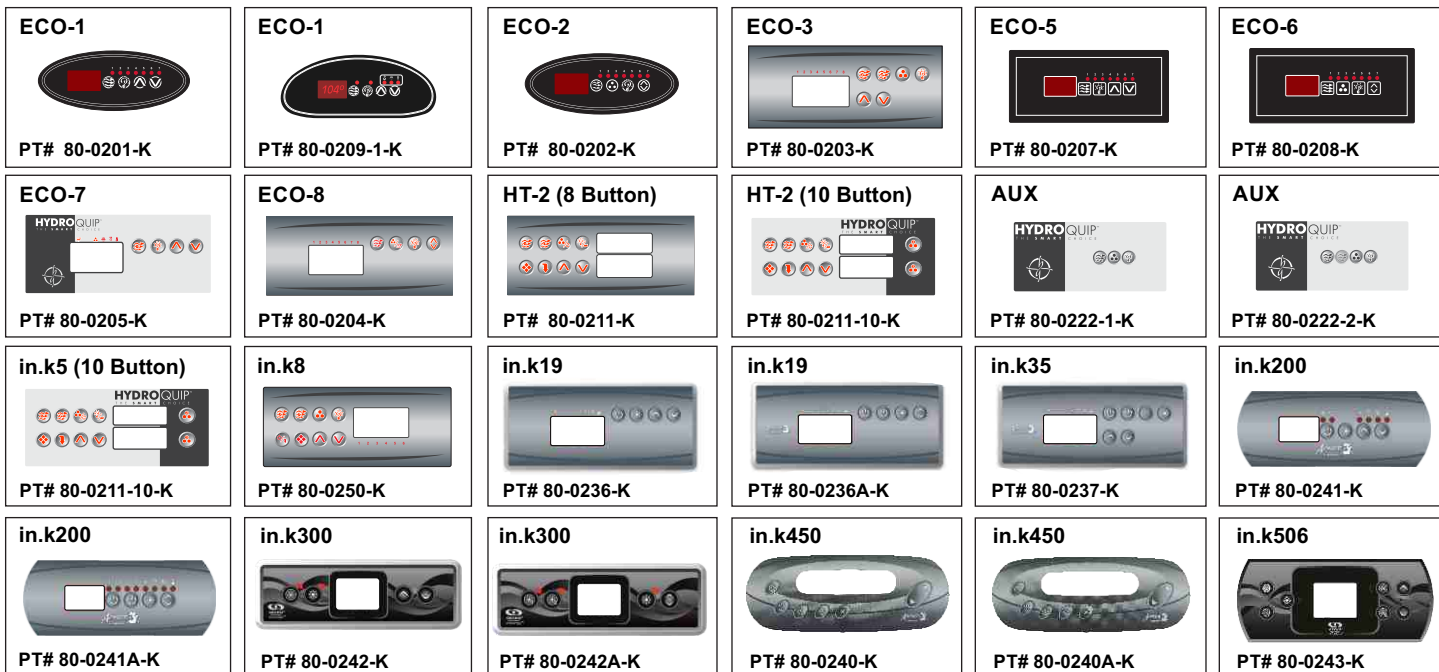

PT #	DESCRIPTION
Gecko Spaside Overlays For Gecko S-Class Series by HQ	
80-0201-K	ECO-1, 4BTN, P1/L/UP/DN
80-0209-1-K	ECO-1, Crescent, 4BTN, P1/LT/UP/DN
80-0202-K	ECO-2, 4BTN, P1/BL/L/TEMP
80-0203-K	ECO-3, 6BTN, P1/P2/BL/LT/UP/DN
80-0207-K	ECO-5, 4BTN, P1/LT/UP/DN
80-0208-K	ECO-6, 4BTN, P1/BL/LT/TEMP
80-0205-K	ECO-7, 4BTN, P1/LT/UP/DN
80-0204-K	ECO-8, 4BTN, P1/BL/LT/TEMP
80-0222-1-K	AUX, 3BTN, P1/BL/LT
80-0222-2-K	AUX, 4BTN, P1/P2/BL/LT
Gecko Spaside Overlays For Gecko M-Class Series by HQ	
80-0211-10-K	HT-2, 10BTN, P1/P2/BL/LT/PG/EC/UP/DN/ACC1/ACC2
80-0211-K	HT-2, 8BTN, P1/P2/BL/LT/PG/EC/UP/DN
Gecko Spaside Overlays For Gecko Y Series by HQ	
80-0211-10-K	in.k5, 10BTN, P1/P2/BL/LT/PG/EC/UP/DN
80-0250-K	in.k8, 8BTN, P1/P2/BL/LT/M/PG/UP/DN
80-0236-K	in.k19, 4BTN, P1/LT/UP/DN
80-0236A-K	in.k19, 4BTN, P1/AUX/LT/TEMP
80-0237-K	in.k35, 6BTN, P1/P2/AUX/LT/UP/DN
80-0241-K	K200, 4 BTN, P1/LT/UP/DN
80-0241A-K	K200, 4 BTN, P1/P2/LT/TEMP
80-0242-K	K300, 4 BTN, P1/LT/UP/DN
80-0242A-K	K300, 4 BTN, P1/P2/LT/TEMP
80-0240-K	K450, 6 BTN, ON/P1/P2/LT/UP/DN
80-0240A-K	K450, 7 BTN, ON/P1/P2/P3/LT/UP/DN
80-0243-K	K506, 7 BTN, S/LT/M/P1/P2/UP/DN

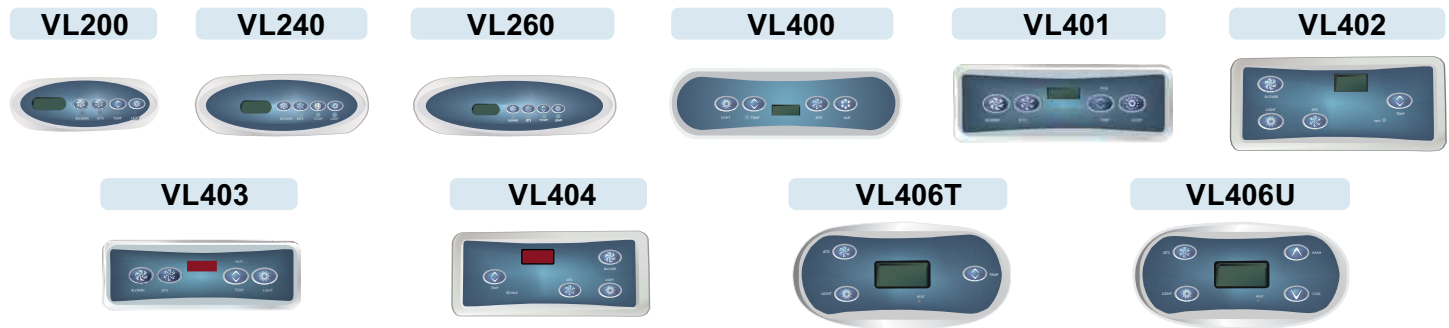

PT #	DESCRIPTION	PT #	DESCRIPTION
VL200 Panel Series, LCD, 4.3"x1.6"		For VS Duplex Systems	
34-52144-K	VL200, w/11095, B/J/T/L	34-55123-K	VL200, w/11852, J/L/C/W
34-52312-K	VL200, w/11127, J/J/T/L	34-55431-K	VL200, w/11219, J/T/L
34-52487-K	VL200, w/11219, J/T/L	34-55563-K	VL200, w/11852, J/L/C/W
34-53238-K	VL200, w/11393, W/C/J/L	34-55472-K	VL200, NO Label, CLR
VL240 Panel Series, LCD, 5.3"x1.9"		For VS Duplex Systems	
34-53565-K	VL240, w/11520, B/J/T/L	34-55080-K	VL240, w/11745, J/L/C/W
34-53643-C1-K	VL240, w/11765, J/T/L	34-55456-K	VL240, w/11745, J/L/C/W
34-53643-K	VL240, w/11520, B/J/T/L	34-59020-K	VL240, NO Label, CLR,
VL260 Panel Series, LCD, 7" X 2.1"		For VS Duplex Systems	
34-53566-K	VL260, w/11521, B/J/T/L, W*	34-55051-K	VL260, w/11725, J/J/T/L
34-53645-K	VL260, w/11521, B/J/T/L, G*	34-55081-K	VL260, w/11746, J/L/C/W
34-53777-K	VL260, w/11521, B/J/T/L, G*	34-55559-K	VL260, w/12050, A/J/T/L
34-54685-K	VL260, w/11724, J/T/L, G*	34-53637-K	VL260, NO Label
34-55049-K	VL260, w/11725, J/J/T/L, W*	34-53999-K	VL260, NO Label, CLR
34-55050-K	VL260, w/11725, J/J/T/L, G*		
VL400 Panel Series, LCD, 7.5" X 2.3"		For VS Duplex Systems	
34-50175-K	VL400, w/2238, L/T/J	34-55129-K	VL400, w/11822, L/T/J/A
34-50176-K	VL400, w/12237, L/T/J/J	34-55130-K	VL400. NO Label
VL401 Panel Series, LCD, 6.3" X 2.2"		For VS Duplex Systems	
34-52274-K	VL401, ICON, w/11853, W/J/L/C	34-54251-K	VL401, w/11671, J/J/T/L
34-54094-K	VL401, w/10669, B/J/T/L	34-54665-K	VL401, w/11885, J/L/C/W
34-54135-K	VL401, w/10839, J/T/L	34-52424-K	VL401, NO Label, CLR
VL402 Panel Series, LCD, 7.3" X 3.2"		For VS Duplex Systems	
34-54093-K	VL402, w/10668, B/L/J/T	34-54107K	VL402, w/10764, J/L/J/T
34-54100-K	VL402, w/10721, L/J/T	34-51876-K	VL402, NO Label
VL403 Panel Series, LED, 6.3" X 2.2"		For VS Duplex Systems	
34-51676-K	VL403, w/10671, B/J/T/L	34-54105-K	VL403, LCD, w/10753, J/T/L
34-52345-K	VL403, w/11448, J/L/W/C	34-54664-K	VL403, LCD, w/11884, J/L/C/W
34-54104-K	VL403, w/10752, J/J/T/L	34-54130-K	VL403, LCD, NO Label
VL404 Panel Series, LED, 7.3" X 3.2"		For VS Duplex Systems	
34-51223-K	VL404, w/10307, T/B/J/L	34-51248-K	VL404, LED, w/10418, T/J/J/L
34-51225-K	VL404, w/10352, T/J/L	34-52825-K	VL404, LED, NO Label
VL406T Panel Series, LCD, 7" X 3.4"		For VS Duplex Systems	
34-50217-K	VL406T, w/12438, J/L/T	34-55570-K	VL406T, w/12051, J/J/L/T
34-55570-K	VL406T, w/11946, J/B/L/T	34-55413-K	VL406T, NO Label
VL406U Panel Series, LCD, 7" X 3.4"		For VS Duplex Systems	
34-53272-K	VL406U, w/11947, J/L/W/C		
34-55350-K	VL406U, w/11947, J/L/W/C		
34-53271-K	VL406U, NO Label		







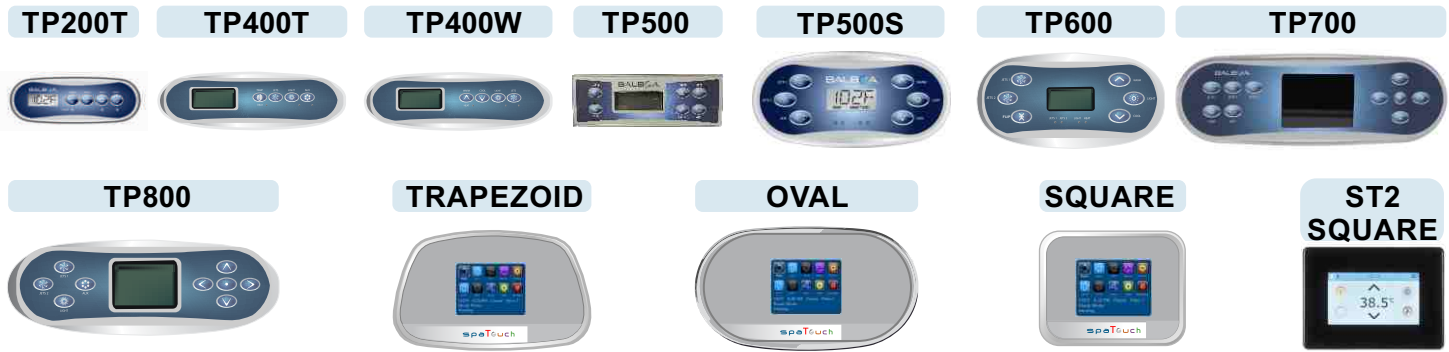

PT #	DESCRIPTION	PT #	DESCRIPTION
VL600S Panel Series, LCD, 7" X 3.4"		For VS Standard Systems	
34-54547-K	VL600S, w/11773, J/B/L/W/M/C	34-54681-K	VL600S, w/11877, J/A/L/W/M/C
34-54548-K	VL600S, w/11774, J/J/L/W/M/C	34-54546-K	VL600S, NO Label
VL620S Panel Series, LCD, 7" X 3.4"		For VS Standard Systems	
34-50055-K	VL620S, w/12220, J/J/L/W/M/C	34-55582-K	VL620S, NO Label
VL700S Panel Series, LCD, 9.8" X 3.1"		For VS Standard Systems	
34-53811-K	VL700S, w/11688, W/M/C/L/B/J/J	34-53812-K	VL700S, NO Label
34-54716-K	VL700S, w/11756, W/M/C/L/J/J		
VL701S Panel Series, LCD, 7.4" X 3.3"		For VS Standard Systems	
34-51057-K	VL701S, w/10328, M/W/J/B/L/C	34-54170-K	VL701S, w/11159, A/M/W/J/J/L/C
34-51247-K	VL701S, w/10402, M/W/J/J/L/C	34-55390-K	VL701S, w/11984, L/M/J/J/J/W/C
34-51452-K	VL701S, w/10429, M/J/L/W/C	34-51112-K	VL701S, NO Label
34-53189-K	VL701S, w/10430, B/M/J/J/L/W/C		
VL702S Panel Series, LCD, 10.3" X 4.6"		For VS Standard Systems	
34-54539-K	VL702S, w/11790, B/M/J/J/L/W/C	34-55129-K	VL702S, NO Label
VL801D Panel Series, LCD, 7.4" X 3.3"		For VS Deluxe Systems	
34-54108-K	VL801D, w/10763, T/M/W/B/L/C/J/J"	34-54142-K	VL801D, w/10841, T/M/W/L/C/J/J
34-54128-K	VL801D, w/10823, T/M/W/B/L/C/J/A"	34-54121-K	VL801D, NO Label
VL802D Panel Series, LCD, 10.3" X 4.6"		For VS Deluxe Systems	
34-54539-K	VL802D, w/11789, T/M/W/B/L/C/J/J	34-54562-K	VL802D, NO Label
ML200 Panel Series, LCD, 4.3" X 1.6"		For EL Systems	
34-52685-K	ML200, w/11344, J/A/T/L	34-53292-K	ML200, NO Label
ML400 Panel Series, LCD, 7.5" X 2.3"		For EL Systems	
34-52684-K	ML400, w/11345, J/A/T/L	34-53291-K	ML400, NO Label
ML550 Panel Series, LCD, 13.7" X 2.5"		For EL Systems	
34-53392-K	ML550, w/11909, C/W/J/J/B/L/M	34-54142-K	ML550, w/12183, C/W/J/J/J/J/L/M
34-54128-K	ML550, w/11901, C/W/J/J/J/L/M	34-53393-K	ML550, NO Label
ML551 Panel Series, LCD, 7.4" X 3.3"		For EL Systems	
34-53502-K	ML551, w/11609, L/M/W/J/J/B/C	34-55600-K	ML551, w/12052, J/L/M/J/J/J/W/C
34-55304-K	ML551, w/11899, L/M/J/J/J/W/C	34-53503-K	ML551, NO Label
ML700 Panel Series, LCD, 9.8" X 3.1"		For EL Systems	
34-52649-K	ML700, w/11281, T/W/M/C/L/B/J/J	34-55609-K	ML700, w/12053, T/W/M/C/L/B/J
34-53567-K	ML700, w/11476, T/W/M/C/L/J/J/J	34-50563-K	ML700, NO Label
ML900 Panel Series, LCD, 11.7" X 3.2"		For EL Systems	
34-55536-K	ML900, w/112037, T/W/M/C/J/J/J/J/I/L/B/J		
34-54589-K	ML900, w/11806, T/W/M/C/J/J/J/J/I/F/L/O		
34-55580-K	ML900, w/12132, T/W/M/C/J/J/J/J/I/L/B/O		
34-52654-K	ML900, w/40026, T/W/M/C/J/J/J/O/I/F/L/B		
34-52797-K	ML900, NO Label		





PT #	DESCRIPTION	PT #	DESCRIPTION	
TP200 Panel Series, LCD, 4.3" X 1.59"				For BP Systems
34-57282-K	TP200, w/17325, T/J/L/A	34-57281-K	TP200T, NO Label	
TP400T Panel Series, LCD, 8.3" X 2.5"				For BP Systems
34-50260-K	TP400T, w/12511, T/J/L/A	34-50260-K	TP400T, NO Label	
TP400W Panel Series, LCD, 8.3" X 2.5"				For BP Systems
34-50259-K	TP400W, w/12510, W/C/L/J	34-55702-K	TP400W, NO Label	
TP500 Panel Series, LCD, 6.32" X 2.25"				For BP Systems
34-57237-K	TP500, w/17183, J/A/L/T	34-57238-K	TP500, NO Label	
34-57251-K	TP500S, w/17204, J/A/L/T	34-57252-K	TP500S, NO Label	
TP600 Panel Series, LCD, 7.1" X 3.5"				For BP Systems
34-50056-K	TP600, w/12198, J/J/F/W/L/C	34-55673-K	TP600, w/12101, J/A/F/W/L/C	
34-50335-K	TP600, w/12762, J/J/A/W/L/C	34-55676-K	TP600, NO Label	
TP700 Panel Series, LCD, 10" X 3.5"				For BP Systems
34-57279-K	TP700, w/17382, 2 Jet	34-57331-K	TP700, NO Label	
34-57280-K	TP700, w/17381, 3 Jet			
TP800 Panel Series, LCD, 10" X 3.5"				For BP Systems
34-57241-K	TP800, w/12512, 9 button	34-57240-K	TP800, NO Label	
spaTouch Panel Series, Color Display				For BP Systems
34-50390-K	Spatouch, Trapeziod, w/12966, 7.8"x4.7"	34-50587-K	Spatouch1, Square, w/Label, 5.6"x4.4"	
34-50401-K	Spatouch, Square, w/12974, 5.6"x4.4"	34-50588-K	Spatouch1, Oval, NO Label, 8.8"x4.9"	
34-50403-K	Spatouch, Oval, w/Label, 8.8"x4.9"	34-50589-K	Spatouch1, Oval, w/Label, 8.8"x4.9"	
34-50584-K	Spatouch1, Trapeziod, NO Label, 7.8"x4.7"	34-57179-K	Spatouch2T, Square, Blk Frm, 5.8"x4.2"	
LITE LEADER		LL ICON15		AX10
				
AX40		VX40S		
				
Lite Leader Panel Series, LED, 4.6" X 2.3"				For Lite Leader Systems
34-51705-K	LL, w/10694, L-J/T	34-51499-K	Lite Leader, NO Label	
Lite Leader ICON Panel Series, LCD, 6.3" X 2.2"				For Lite Leader Icon Systems
34-55574-K	LL, ICON15, w/11853, W/J/L/C	34-52424K	LL, ICON15, NO Label	
AX10 Auxiliary Panel Series, 2.2" X 2.2"				For EL/BP Systems
34-55533-K	AX10, w/Jets 3 Label			
AX40 Panel Series, 7.5" X 2.3"				For EL/BP Systems
34-52678-K	AX40, w/40030, P/P/B/L	34-55487-K	AX40, w/11823, J/J/J/J	
34-53334-K	AX40, w/11428, J/J/B/J	34-52799-K	AX40, NO Label	
VX40 Panel Series, 7.5" X 2.3"				For VS Systems
34-51574-K	VX40, w/10559, P/P/B/L	34-52576-K	VX40, NO Label	



34-VL200-U

34-VL401-U

34-VL403-U

34-VL701-U



PT #

DESCRIPTION

34-VL200-U

Universal Spaside for Balboa **VL200** Series

Replaces: 54327, 54451, 54528, 54539, 54546, 54547

34-VL401-U

Universal Spaside for Balboa **VL401** Series

Replaces: 55130, 55304, 55349, 55350

34-VL403-U

Universal Spaside for Balboa **VL403** Series

Replaces: 55413, 55417, 55431, 55456, 55472

34-VL701-U

Universal Spaside for Balboa **VL701S** Series

Replaces: 55702, 55989, 56046, 57180, 57237, 57238, 57240

Gaskets

Balboa® Spaside Foam Gaskets

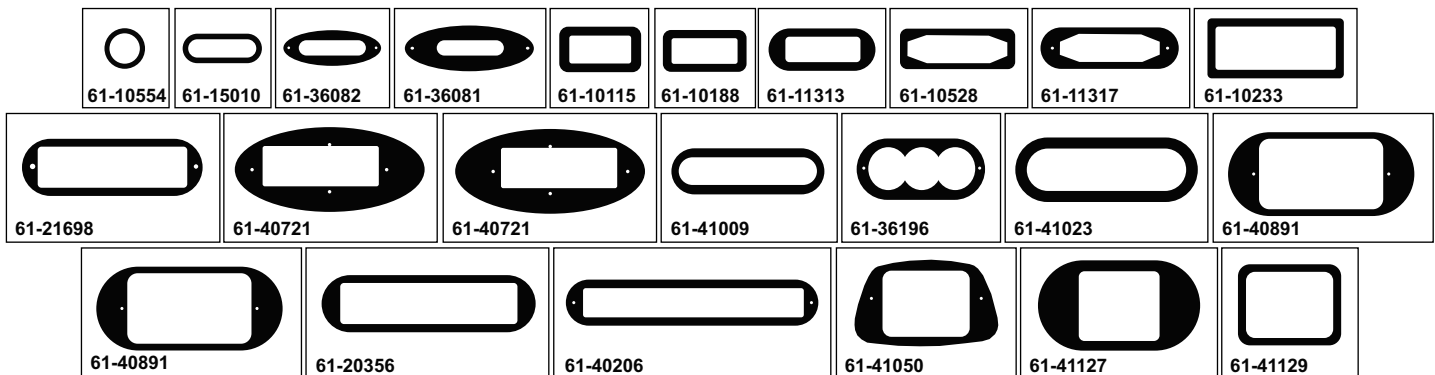

PT #	DESCRIPTION	PT #	DESCRIPTION
61-10115	Lite Leader(51499)	61-36082	VL240 (53636, 53644)
61-10188	Duplex w/Knob(51219)	61-36196	TP600 (55676, 56046), VL406T (50210, 50222, 55413), & VL406U (53271, 55417), VL600S (54546), VL620S (55582)
61-10233	VL701S (50617, 54112), VL801D (54121), & ML551 (53503), VL402 (51876), VL404 (52825)	61-40206	ML550 (53393)
61-10528	VL401 (52424), VL403 (54130)	61-40721	VL802D (54562), VL702S (54539)
61-10554	AX10 , Single Button Aux	61-40891	TP900 (50262)
61-11313	AX20 , Two Button Aux	61-41009	TP400T (55701), TP400W (55702)
61-11317	ML400 (53291), VL400 (55130), AX40 (52799)	61-41023	TP800 (50204, 57240)
61-15010	VL200 (53676, 54252, 55472)	61-41050	Spatouch Trapezoid (50391)
61-20356	ML900 (52797)	61-41127	Spatouch Oval (50588)
61-21698	ML700 (50563), VL700S (53812)	61-41129	Spatouch Square (50586)
61-36081	VL260 (53646, 53637, 53999)		

**Shapes shown only, gaskets are not black

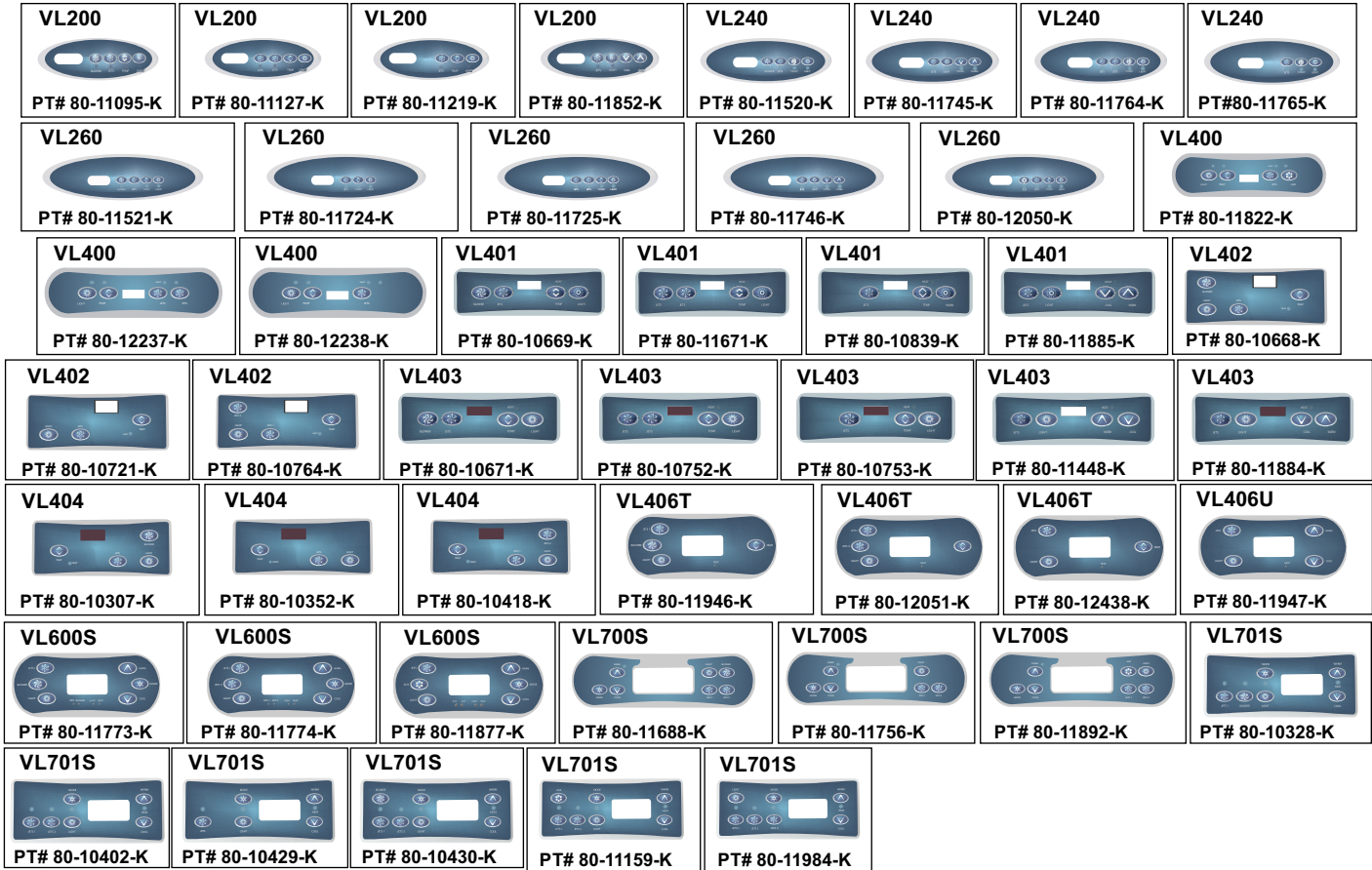

<i>PT #</i>	<i>DESCRIPTION</i>	<i>PT #</i>	<i>DESCRIPTION</i>
VL Panel Overlays (Designed for VS/Duplex Systems)			
80-11095-K	VL200, B/J/T/L	80-11671-K	VL401, J/J/T/L
80-11127-K	VL200, J/J/T/L	80-11885-K	VL401, J/L/C/W
80-11852-K	VL200, J/L/C/W	80-10839-K	VL401, J/T/L
80-11219-K	VL200, J/T/L	80-10668-K	VL402, B/L/J/T
80-11520-K	VL240, B/J/T/L	80-10764-K	VL402, J/L/J/T
80-11764-K	VL240, J/J/T/L	80-10721-K	VL402, L/J/T
80-11745-K	VL240, J/L/C/W	80-10671-K	VL403, B/J/T/L
80-11765-K	VL240, J/T/L	80-10752-K	VL403, J/J/T/L
80-12050-K	VL260, A/J/T/L	80-11884-K	VL403, J/L/C/W
80-11521-K	VL260, B/J/T/L	80-11448-K	VL403, J/L/W/C
80-11725-K	VL260, J/J/T/L	80-10753-K	VL403, J/T/L
80-11746-K	VL260, J/L/C/W	80-10307-K	VL404, T/B/J/L
80-11724-K	VL260, J/T/L	80-10418-K	VL404, T/J/J/L
80-12238-K	VL400, L/T/J	80-10352-K	VL404, T/J/L
80-11822-K	VL400, L/T/J/A	80-11946-K	VL406T, J/B/L/T
80-12237-K	VL400, L/T/J/J	80-12051-K	VL406T, J/J/L/T
80-10669-K	VL401, B/J/T/L	80-12438-K	VL406T, J/L/T
		80-11947-K	VL406U, J/L/W/C
VL Panel Overlays (Designed for VS/Standard Systems)			
80-11773-K	VL600S, J/B/L/W/M/C	80-10430-K	VL701S, B/M/J/J/L/W/C
80-11774-K	VL600S, J/J/L/W/M/C	80-10429-K	VL701S, M/J/L/W/C
80-11877-K	VL600S, J/A/L/W/M/C	80-10402-K	VL701S, M/W/J/J/L/C
80-11892-K	VL700S, W/M/C/A/L/J/J	80-11159-K	VL701S, A/M/J/J/L/W/C
80-11688-K	VL700S, W/M/C/L/B/J/J	80-11984-K	VL701S, L/M/J/J/J/W/C
80-11756-K	VL700S, W/M/C/L/J/J	80-10328-K	VL701S, M/J/B/L/W/C

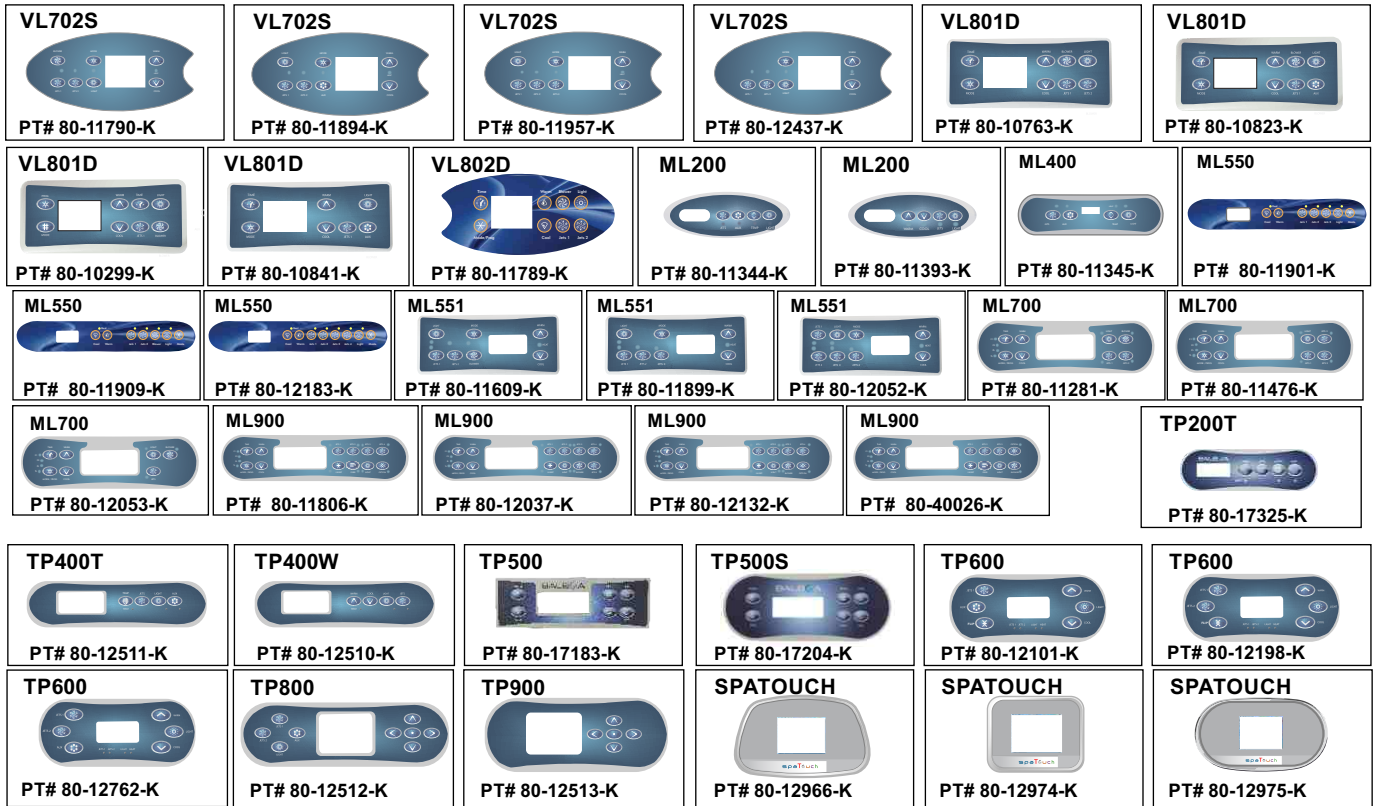

PT #	DESCRIPTION	PT #	DESCRIPTION
VL Panel Overlays (Designed for VS/Standard & Deluxe Systems)			
80-11790-K	VL702S, B/M/J/J/L/W/C	80-10823-K	VL801D, T/M/W/B/L/C/J/A
80-11894-K	VL702S, L/M/J/J/L/W/C	80-10763-K	VL801D, T/M/W/B/L/C/J/J
80-11957-K	VL702S, L/M/J/J/L/W/C	80-10841-K	VL801D, T/M/W/L/C/J/J
80-12437-K	VL702S, M/J/J/L/W/C	80-11789-K	VL802D, T/M/W/B/L/C/J/J
		80-10299-K	VL801D, P/M/W/T/L/C/J/B
ML Panel Overlays (Designed for EL/GL Systems)			
80-11344-K	ML200, J/A/T/L	80-11609-K	ML551, L/M/W/J/J/B/C
80-11393-K	ML200, W/C/J/L	80-12053-K	ML700, T/W/M/C/L/B/J
80-11345-K	ML400, J/A/T/L	80-11281-K	ML700, T/W/M/C/L/B/J/J
80-11909-K	ML550, C/W/J/J/B/L/M	80-11476-K	ML700, T/W/M/C/L/J/J/J
80-12183-K	ML550, C/W/J/J/J/L/M	80-11806-K	ML900, T/W/M/C/J/J/J/J/I/F/L/O
80-11901-K	ML550, C/W/J/J/J/L/M	80-12132-K	ML900, T/W/M/C/J/J/J/J/I/L/B/O
80-12052-K	ML551, J/L/M/J/J/W/C	80-12037-K	ML900, T/W/M/C/J/J/J/J/I/L/B/O
80-11899-K	ML551, L/M/J/J/J/W/C	80-40026-K	ML900, T/W/M/C/J/J/J/O/I/F/L/E
TP Panel Overlays (Designed for BP Systems)			
80-17325-K	TP200T, T/J/L/A	80-12198-K	TP600, J/J/F/W/L/C
80-12511-K	TP400T, T/J/L/A	80-12512-K	TP800, J/J/L/A
80-12510-K	TP400W, W/C/L/J	80-12513-K	TP900, 5 BUTTON
80-17183-K	TP500, W/C/M/L/J	80-12966-K	TRAP, SPATOUCH
80-12101-K	TP600, J/A/F/W/L/	80-12975-K	OVAL, SPATOUCH
80-12762-K	TP600, J/J/A/W/L/	80-12974-K	REC, SPATOUCH
80-17204-K	TP500S, W/C/M/L/J/A		

Balboa® Series Spaside Overlays



HYDROQUIP™
THE **SMART CHOICE™**

LL 2 BTN PT# 80-10694-K	ICON15 PT# 80-11853-K	AX10 PT# 80-11907-K	AX10 PT# 80-11908-K	AX10 PT# 80-12122-K	AX10 PT# 80-40105-K	AX20 PT# 80-40096-K	AX20 PT# 80-40097-K
AX20 PT# 80-40098-K	AX40 PT# 80-11428-K	AX40 PT# 80-11762-K	AX40 PT# 80-11823-K	AX40 PT# 80-40030-K	VX40S PT# 80-10559-K		

PT # **DESCRIPTION**

LL Panel Overlays(Designed for Lite Leader Systems)

80-10694-K	LL, J-L/T
80-11853-K	LL ICON, W/J/L/C

AX Panel Overlays(Designed for EL/GL/BP Systems)

80-11907-K	AX10, Jets 3
80-11908-K	AX10, Jets 4
80-12122-K	AX10, Jets 5
80-40105-K	AX10, Jets 1
80-40096-K	AX20, J/J
80-40097-K	AX20, J/L
80-40098-K	AX20, J/B
80-11428-K	AX40, J/J/B/J
80-11762-K	AX40, J/L/B
80-11823-K	AX40, J/J/J/J
80-40030-K	AX40, J/J/B/L
80-10559-K	VX40S, VS, RE, J/J/B/L

Universal Spaside Overlays Balboa® Series by HQ

VL200 PT# 80-VL200-K	VL240 PT# 80-VL240-K	VL260 PT# 80-VL260-K	VL401/403 PT# 80-VL400/03-K	VL701S PT# 80-VL701S-K
TP200 PT# 80-TP200-K	TP500 PT# 80-TP500-K	TP500B PT# 80-TP500B-K	TP600 PT# 80-TP600-K	

Universal Balboa Overlays(Designed for VS/BP Systems)

PT #	DESCRIPTION	PT #	DESCRIPTION
80-VL200-K	Universal VL200	80-TP 200-K	Universal TP200
80-VL240-K	Universal VL240	80-TP 500-K	Universal TP500
80-VL260-K	Universal VL260	80-TP 500B-K	Universal TP500B
80-VL400/03-K	Universal VL401 & 403	80-TP 600-K	Universal TP600
80-VL701S-K	Universal VL701S		

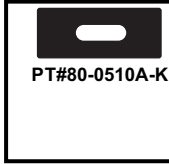

PART#	DESCRIPTION
Balboa Series WiFi Accessories	
34-51159-K	BP Series, Module, Wi-Fi Kit
34-53469	Remote, Transceiver, Balboa, I/H
30-25657	Adapter, BP Series, "Y" Cable, Wi-Fi, BWG# 25657
Balboa Series Spaside Placards	
80-0510A-K	Placard Kit, ML200, ML240, ML260, VL200, VL240, VL260, 8.5" X 4"
80-0510B-K	Placard Kit, Lite Leader, 8.5" X 4"
80-0510C-K	Placard Kit, AX40, ML400, VL400, VL401, VL403, 8.5" X 4"
80-0511B-K	Placard Kit, ML551, VL402, VL404, VL701S, VL801D, 8.5" X 4"
80-0511A-K	Placard Kit, TP400T, TP400W, 9.06" X 4"
80-0511D-K	Placard Kit, TP600, VL406T, VL406U, VL600S, VL620S, 9.06" X 4"
Balboa Series Spaside Extension Cords	
① 30-22635-25	Ext, 25' VS, 8Pin, with 2 to 1 & 1 to 1 connectors
① 30-22632-50	Ext, 50' VS, 8Pin, with 2 to 1 & 1 to 1 connectors
① 30-22630-100	Ext, 100' VS, 8Pin, with 2 to 1 & 1 to 1 connectors
② 30-25662-7	Ext, 7' BP, 4Pin, Also for Wi-Fi Module (Not Shown)
② 30-25662-25	Ext, 25' BP, 4Pin, Also for Wi-Fi Module
② 30-25662-50	Ext, 50' BP, 4Pin, Also for Wi-Fi Module
② 30-25662-100	Ext, 100' BP, 4Pin, Also for Wi-Fi Module
③ 30-11589-25	Ext, 25' EL, 6Pin, Aux
③ 30-11589-50	Ext, 50' EL, 6Pin, Aux
③ 30-11589-100	Ext, 100' EL, 6Pin, Aux
④ 30-11588-25	Ext, 25' EL, 8-Pin, Main
④ 30-11588-50	Ext, 50' EL, 8Pin, Main
④ 30-11588-100	Ext, 100' EL, 8Pin, Main

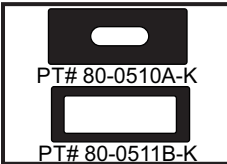

PART#	DESCRIPTION
Gecko Series WiFi Accessories	
34-0216G-K	WiFi, Module, In.Touch2, Y Series
Gecko Series Spaside Placards	
80-0510A-K	Placard Kit, ECO-1,2,5,6 Series, 8.5" X 4"
80-0511B-K	Placard Kit, HT-2 & ECO-3,7,8 Series, 8.5" X 4"
80-0511F-K	Placard Kit, K450, 8.5" X 4"(not shown)
Gecko Series Spaside Extension Cords	
30-1011-9	Ext, 9', Mspa/Sspa
30-1011-20	Ext, 20', Mspa/Sspa
30-1011-25	Ext, 25', Mspa/Sspa

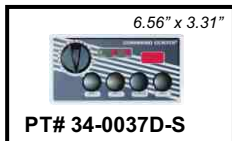

PART NUMBER	DESCRIPTION	INCLUDES
34-0037A-S	Obsolete, Use PT# 34-0037D-S	Label: 80-0132A
34-0039A-S	Obsolete, Use PT# 34-0039D-S	Label: 80-0134A
34-0038A-S	Obsolete, Use PT# 34-0038D-S	Label: 80-0130A
34-0037D-S	Spaside Kit, TDI CC4D, 120V, 6' Cord, Digital, 4BTN Label	Label: 80-0134D
34-0039D-S	Spaside Kit, TDI CC3D, 120V, 6' Cord, Digital, 3BTN Label	Label: 80-0132D
34-0038D-S	Spaside Kit, TDI CC2D, 120V, 6' Cord, Digital, 2BTN Label	Label: 80-0130D
80-0499	Placard, LG to TDI, Full Size, 8.25" X 3.25" (not shown)	
09-0004	Receptacle, Spaside Control (not shown)	

Air Switches/Transmitters



PART NUMBER	DESCRIPTION
34-0002-K	Air Switch, 125/250V, 25A, SPDT
34-0059-K	Air Switch, 125/250V, 20A, DPDT
34-0020-K	Rocker Switch, SPDT, 125V, 16A
34-0154	Air Switch, 3 Function, 250V, 21A
36-0006	Air Transmitter, Chrome, #15, 1 3/8"
36-0004A-K	Air Transmitter, White, #15, 1 1/4"
64-0001B	Tubing, 1/4"OD X 1/8" ID, Clear (per ft)
64-0001B-5	Tubing, 1/4"OD X 1/8" ID, Clear (5 ft roll)
64-0001B-10	Tubing, 1/4"OD X 1/8" ID, Clear (10 ft roll)
64-0001B-100	Tubing, 1/4"OD X 1/8" ID, Clear (100 ft roll)
64-0012	Tubing, Long Distance, 1/8"OD X 1/16" ID, Clear (per ft)



PART NUMBER	DESCRIPTION
34-0153-K	Pressure Switch, 120V, 3A, 1/8" thread 2PSI (adjustable) Manf.# 3158-EN
34-30379	Pressure Switch, Guard for PT# 34-0153-K
34-0178-K	Pressure Switch, 120V, 1A, 1/8" thread 1.50PSI (adjustable) Manf.# 3903-EECS
34-0178B-K	Pressure Switch, 120V, 1A, 1/8" thread 1.75PSI (adjustable) Manf.# 3903-EMCS
34-0178A-K	Replaced with 34-0178C-K
34-0178C-K	Pressure Switch, 120V, 1A, 1/8" thread 2PSI (adjustable)
34-0148A-K	Replaced with 34-0148D-K
34-0148D-K	Pressure Switch, 125V, 15.1A, 1/8" thread 2.5PSI, Deep Tub (not adjustable)
34-0019-C-K	Pressure Switch, 240V, 25A, 1/8" thread (adjustable) Manf.# 4010P replaces 3010P
34-0069C-K	Vacuum Switch, 125V, 12.5A, 1/8" thread (not adjustable)
34-0217-K	Flow Switch, 30V, 1A, 6' Cord, X=0.50" NPT, Y= 1.4"
34-0221-K	Flow Switch, 30V, 1A, 3/4" Barb size
34-0221A-K	Flow Switch, 30V, 1A, 4' Cord, X= 0.75" NPT, Y= 1.1"
34-0221B-K	Flow Switch, 30V, 1A, 3/4" x 1/2" Barb-Slip
48-0120*	Flow Switch Kit, 30V, 1A, 6' Cord 2"X2" W/1.5" Reducers
48-0120B	Flow Switch Kit, Air, 30V, 1A, 6' Cord 2"X2" W/1.5" Reducers
48-0223A	Flow Switch, 30V, 1A, 2" PVC Tee, AMP Plug (Not Shown)
48-0223B-K	Flow Switch, 30V, 1A, 3/4" Barb size, Molded Plug (Not Shown)
48-0223C	Flow Switch, 30V, 1A, 3/4" Barb size, MP/U/W, PCB Connect
48-0223G-HQ	Flow Switch, 30V, 1A, 3/4" Barb size, Molex Connector
34-0199F-K	Harness, PSI, SS, 14"
42-0013-K	Adapter, Barb, 3/4" X 1", PVC
48-0310-K	Adapter, Pump, Tubing Step Down Kit, from 1" to 3/4"

* Used w/series: 4100, 4200, 4220, 4230, 4330, 6100, 6200, 6220, 6230, 6330, 7100, 7500, 9700



PART NUMBER	DESCRIPTION
35-0002-K	Relay, SPDT, 120V, 15A, T-91
35-0003-K	Relay, SPDT, 240V, 15A, T-91
35-0012-K	Contactors, DPST, 120V, 30/40A
35-0014-K	Contactors, DPST, 120V, 50A
35-0025-K	Contactors, SPST, 120V, 30A
35-0026-K	Contactors, SPST, 240V, 30A
35-0028-K	Base, Relay Mounting, SE
35-0031-K	Contactors, DPST, 240V, 40/50A
35-0031A	Relay, DPDT, 240V, 10A
35-0036-K	Relay, DPST, 120V, 30A, T-92
35-0037-K	Relay, DPDT, 240V, 30A, T-92
35-0077-K	Relay, DPDT, 120V, 30A, T-92
35-0078-K	Relay, DPDT, 240VAC, 10A, Baptismal

Thermostats, High-limits & Timers



PART NUMBER	DESCRIPTION
34-0081-K	Thermostat, 120V, 1A, Solid State (TDI), 1/4" Bulb, 36" CAP
34-0081B-K	Thermostat, 120V, 1A, Solid State (TDI), 1/4" Bulb, 72" CAP (Not Shown)
34-0081C-K	Thermostat, 120V, 1A, Solid State (TDI), 3/8" Bulb, 10" CAP (Not Shown)
34-0030-K	Thermostat, 5/16 Bulb, 24" CAP
48-0013	Thermostat Knob, Univ.
34-0010-K	High Limit, TCO, Auto, 130F
34-0012-K	High Limit, 5/16 Bulb, 24" CAP
34-0012A-K	High Limit, 1/4" Bulb, 36" CAP
34-0058-K	High Limit, Thermodisc, 250V, 50A
48-0092S	High Limit, with Auto Reset, Complete Kit
34-0035-K	Timer, 7 Day, 120V, 60HZ, 21A, STD
34-0036-K	Timer, 7 Day, 240V, 60HZ, STD (Not Shown)
34-0033-K	Timer, 24HR, 120V, 60HZ, 21A, w/Override Switch
34-0052A-K	Timer, 24HR, 240V, 50 HZ, 21A, STD, w/Override Switch (Not Shown)
34-0049-K	Timer, 24HR, 240V, 60HZ, STD, w/Override Switch (Not Shown)

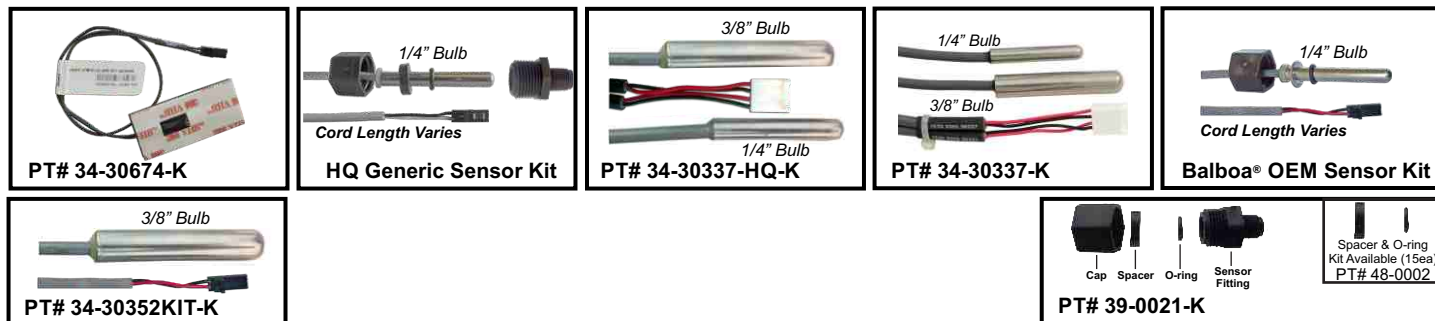

PART NUMBER	DESCRIPTION
34-30674-K	Balboa® OEM Sensor, M7®, 12", Temp/HL, Stick On, Cal Spa Series
34-0202B-K	HQ Generic Sensor Kit, M7®, 46", 1/4" Bulb, Balboa®, All Slide Series
34-0202C-K	HQ Generic Sensor Kit, M7®, 82", 1/4" Bulb, Balboa®, Versi-Heat Series
34-30337-HQ-K	HQ Generic Sensor Kit, Dual, Temp/HL, 36"(1/4" Bulb), 96"(3/8" Bulb)
34-30337-K	Balboa® OEM Sensor Kit, Dual, Temp/HL, 36"(1/4" Bulb), 96"(3/8" Bulb)
34-30352KIT-K	HQ Generic Sensor Kit, Temp, 96"(3/8" Bulb)
34-53605-HQ-K	HQ Generic Sensor Kit, M7®, 12", 1/4" Bulb, Includes complete sensor fitting
34-53605-K	Balboa® OEM Sensor Kit, M7®, 12", 1/4" Bulb
34-32016-HQ-K	HQ Generic Sensor Kit, M7®, 24", 1/4" Bulb, Includes complete sensor fitting
34-32016-K	Balboa® OEM Sensor Kit, M7®, 24", 1/4" Bulb
39-0021-K	M7® Sensor Fitting Kit, Includes: Body, Cap, Spacer, and O-Ring
48-0002	M7® Spacer & O-Ring Kit (15 of each per kit)

All HQ Generic M7® Sensor Kits Include Fitting Kit PT# 39-0021-K

Gecko Series Sensors

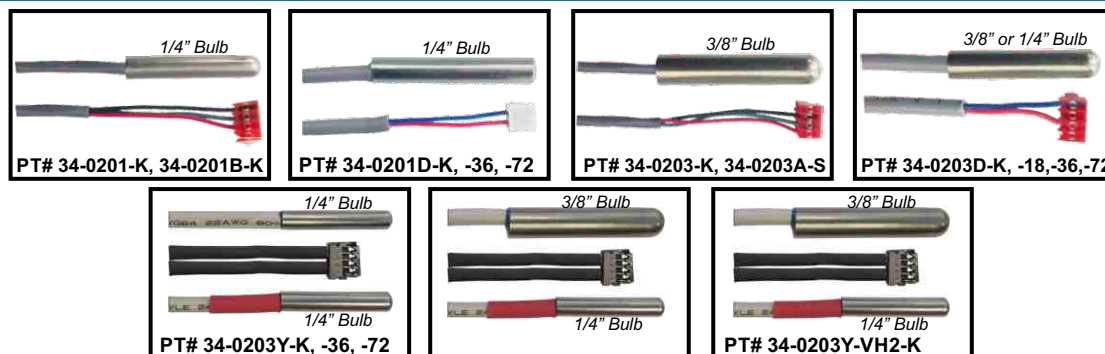

PART NUMBER	DESCRIPTION
34-0201-K*	Sensor, HL, 4P3W, W/M/T, 14", 1/4" Bulb - Gecko# 9920-400122
34-0201B-K*	Sensor, HL, 4P3W, W/M/T, 76", 1/4" Bulb - Gecko# 9920-400684
34-0201D-K	Sensor, HL, 2P2W, MP/SSPA/USPA, 18", 1/4" Bulb
34-0201D-36-K	Sensor, HL, 2P2W, MP/SSPA/USPA, 36", 1/4" Bulb
34-0201D-72-K	Sensor, HL, 2P2W, MP/SSPA/USPA, 72", 1/4" Bulb
34-0203-K*	Sensor, Temp, 4P3W, W/M/T, 10FT, 3/8" Bulb - Gecko# 9920-400125
34-0203A-S*	Sensor, Temp, 4P3W, W/M/T, 25FT., 3/8" Bulb - Gecko# 9920-400245
34-0203D-K	Sensor, Temp, MP/SSPA/USPA, 4P2W, 10FT, 3/8" Bulb - Gecko# 9920-400262
34-0203D-18-K	Sensor, Temp, MP/SSPA/USPA, 4P2W 18", 1/4" Bulb
34-0203D-36-K	Sensor, Temp, MP/SSPA/USPA, 4P2W, 36", 1/4" Bulb
34-0203D-72-K	Sensor, Temp, MP/SSPA/USPA, 4P2W, 72", 1/4" Bulb
34-0203Y-K	Sensor, Temp/HL, Y Series, 18", 1/4" Bulb
34-0203Y-36-K	Sensor, Temp/HL, Y Series, 36", 1/4" Bulb
34-0203Y-72-K	Sensor, Temp/HL, Y Series, 72", 1/4" Bulb
34-0203Y-STD-K	Sensor, Temp/HL, 120"(3/8" Bulb), 18"(1/4" Bulb), Y Series
34-0203Y-VH2-K	Sensor, Temp/HL, 120"(3/8" Bulb), 72"(1/4" Bulb), Y Series

*Only applicable to system series: CS7100/CS6100, CS9300, CS9400 & CS9600 manufactured prior to mid 2003.

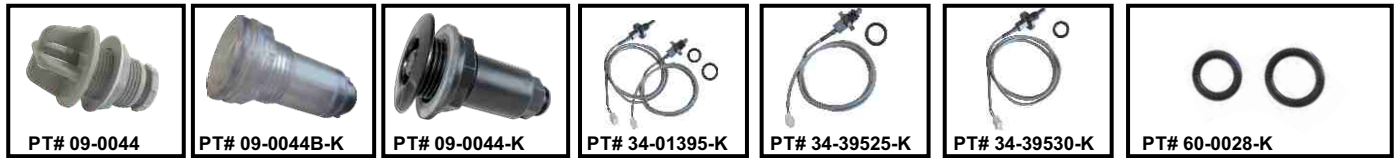

PART NUMBER	DESCRIPTION
09-0044	Thermowell, Wet-Well, 3/8", Hole size 1", 2.36"L X 1.53"W
09-0044B-K	Thermowell, Dry-Well, 3/8", C&S w/ plug, Hole size 1.125", 2.85"L X 1.48"W
09-0044-K	Thermowell Kit, Dry-Well, 3/8", w/ plug, Hole size 1.125", 2.85"L X 1.80"W
34-01395-K	Replacement Sensor Kit for Watkins, Includes Temp Sensor, Hi-Limit & 2 O-Rings
34-39525-K	Replacement Sensor for Watkins, Individual Temp Sensor & O-Ring
34-39530-K	Replacement Sensor for Watkins, Individual Hi-Limit & O-Ring
60-0028-K	Replacement O-Ring Kit for Watkins Sensors, Includes Hi-Limit & Temp Sensor O-Rings

GFCl's & Transformers



PART NUMBER	DESCRIPTION
30-0061B-K	GFCI Powercord, 15A, 90 Degree, 16' STW, Outdoor/Indoor
30-0061C-K	GFCI Powercord, 15A, 90 Degree, 16' SJTW, Indoor Only
30-0061D-K	Obsolete, Use PT# 30-0061B-K
30-0062B-K	GFCI Powercord, 20A, 90 Degree, 16' STW, Outdoor/Indoor
34-0007	GFCI, 20A, Panel Mount, 120V
34-0084-K	GFCI, 15A, 90 Degree, Right Angle, Plug
34-0181L-K	GFCI, 20A, 90 Degree, Right Angle, Plug
37-0002-K	Transformer, Light, 120-12V, 1AMP
37-0005-K	Transformer, BAP, 120- 24V, 1AMP
37-0051-K	Transformer, PCB, 120V (series: 4/6200, 4/6220, 4/6230, 4/6330)
37-0052A-K	Transformer, Balboa®, 120V, LL
37-0053-K	Transformer, 120V, Y Series
37-0053B-K	Transformer, 240V, Y Series
48-0099X-120	Transformer Kit, 120V, MSPA/MP Series
48-0099X-240	Transformer Kit, 240V, MSPA/MP Series

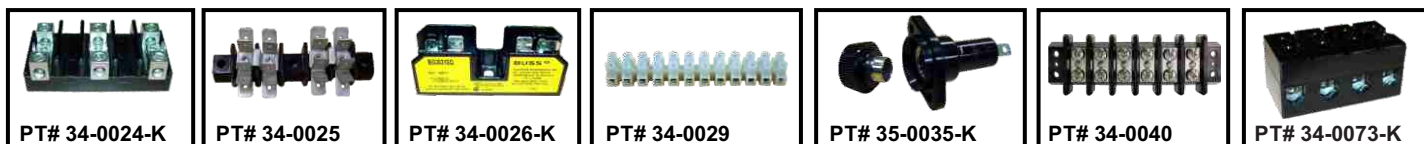
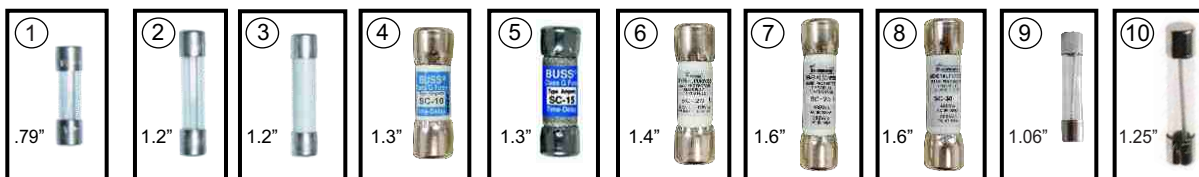

PART NUMBER	DESCRIPTION
34-0024-K	Terminal Block, Input, 4-14 AWG
34-0025	Terminal Block ,12 PIN
34-0026-K	Fuse Block, 30A, Main
34-0029	Terminal Block, 8000, 12 POS
34-0073-K	Terminal Block, Marathon, 4 POS
⑧ 35-0019-K	Fuse, 30A, Main, SC-30
⑧ 35-0019-K5	Fuse, 30A, Main, SC-30 - 5 Pack
⑧ 35-0019-KB	Fuse, 30A, Main, SC-30 - 100 Pack
② 35-0020	Fuse, 3A, Blower, 600W, 240V
② 35-0020A	Fuse, 3A, 3AG, Fast, Light, VS
② 35-0021	Fuse, 4A Blower, 3AG
⑨ 35-0022	Fuse, 6-1/4A, BLWR, 600W, 120V
② 35-0024	Fuse, 12A, Blower, 3AG
② 35-0027-K	Fuse, 300MA, 240V, xformer, VS - Replacement for Balboa PT# 21581 5 Pack
② 35-0032-K	Fuse, 8A, Blower, 800W, 120V
③ 35-0047A-K	Fuse, 20A, Time Delay MDA-20A
③ 35-0047-K	Fuse, 15A, Time Delay
⑥ 35-0058-K	Fuse, 20AMP, Main, SC-20
⑥ 35-0058-K5	Fuse, 20A, Main, SC-20 - 5 Pack
⑥ 35-0058-KB	Fuse, 20A, Main, SC-20 - 100 Pack
⑩ 35-0059	Fuse, 1A, Trans/Light
② 35-0060-K	Fuse, 2A, Ozone
② 35-0061	Fuse, 5A, Blower, 800W, 240V
③ 35-0062-K	Fuse, 10AMP 3AG - Time Delay
35-0063A	Replaced with 35-0063-K
⑦ 35-0063-K	Fuse, 25A, Main, SC-25
⑦ 35-0063-K5	Fuse, 25A, Main, SC-25 - 5 Pack
⑦ 35-0063-KB	Fuse, 25A, Main, SC-25 - 100 Pack
35-0064-K	Fuse, 250MA, 3AG, Fast (not shown)
④ 35-0066-K	Fuse, 10A, SC-10
④ 35-0066-K5	Fuse, 10A, Main, SC-10 - 5 Pack
④ 35-0066-KB	Fuse, 10A, Main, SC-10 - 100 Pack
⑤ 35-0067-K	Fuse, 15A, SC-15
⑤ 35-0067-K5	Fuse, 15A, Main, SC-15 - 5 Pack
⑤ 35-0067-KB	Fuse, 15A, Main, SC-15 - 100 Pack
① 35-0074A-K5	Fuse, 500MA, 240 SSPA, System - 5 Pack
① 35-0074-K	Fuse, 750MA, 120V SSPA, System
35-0074B-K5	Fuse, 500MA, 3AG, Fast (not shown)
35-0074C	Fuse, 500MA, 3AG, Slo (not shown)
① 35-0079-K	Fuse, 2AMP, 250VAC, SSPA Light
③ 35-0080	Fuse, 5AMP Time Delay, 250VAC
35-0081-K	Fuse, 10AMP Time Delay, 250VAC, .79" x .2" Glass
35-21581-K	Fuse, (5 pack) 300MA, 240V, xformer, VS - Replacement for Balboa PT# 21581



PART NUMBER DESCRIPTION

34-0381-K	Ozone, Check Valve
34-0381A-K	Ozone Check Valve, XP
34-0382	Ozone Intake Filter
34-2722-50-K	HydroQuip Water Pro Ozonator Kit, 120V/240V, 50mg
34-2722-100-K	HydroQuip Water Pro Ozonator Kit, 120V/240V, 100mg
34-2722-150-K	HydroQuip Water Pro Ozonator Kit, 120V/240V, 150mg
34-2922-AMP	HydroQuip Water Pro (Mini) Ozonator Kit, 120V/240V, 50mg
34-54451	Replaced by 34-2722-50-K
34-59087-KIT	Replaced by 34-59297-KIT
34-59088-KIT	Replaced by 34-59297-KIT
34-59297-KIT	Balboa® CD Ultrazone™ Ozonator Kit, 120V/240V, 150mg
39-0034A	Clamp, Hose, Nylon, Ozone
42-0500	Ozone Mazzei Injector, 3/4" Barb, 88-K, White
42-0510	Ozone, LGM Mazzei, 3/4" Barb, Grey
49-0410	Ozone Injector Manifold, 1.5", w/LGM
49-0410A	Ozone Injector Manifold, 1.5", 8000 Systems
49-0410B	Ozone Injector Manifold, 1.5", BP/VS Systems
49-0412	Ozone Injector Manifold, 2.0", 8000 Systems
49-0420	Ozone Injector Manifold, 1.5", w/LGM Mazzei
49-0420A	Ozone Injector Manifold, 1.5" Plumbing for Circ & Small HP Pumps
49-0421	Ozone Injector Manifold, 2" Plumbing for Medium to High Flow Pumps
49-0422	Ozone Injector Manifold, 2.5" Plumbing for High Flow Pumps
64-000*	Tubing, 1/4"1D x 3/8"0D, Clear
30-0120A-K	Ozone Adapter Cord, Universal Cord Kit,
30-0120B-K	Ozone Adapter Cord, 4-Pin Amp to 3-Pin Amp
30-0120C-K	Ozone Adapter Cord, 4-Pin Amp to 15A Nema Plug
30-0120D-K	Ozone Adapter Cord, 4-Pin Amp to Mini JJ(Yellow) - Not Shown
30-0120E-K	Ozone Adapter Cord, 4-Pin Amp to Mini JJ(Blue) - Not Shown
30-0120F-K	Ozone Adapter Cord, 4-Pin Amp to Mini JJ(Black) - Not Shown
30-0120G-K	Ozone Adapter Cord, 4-Pin Amp to in.link(Gecko) - Not Shown



PART NUMBER DESCRIPTION

Cluster Main Lighting	
701570-6-DLSO-S	6-LED Cluster with Stand-off 36" Daisy Chain Light
701570-12-DLSO	12-LED Cluster with Stand-off 36" Daisy Chain Light
701570-21-DLSO	21-LED Cluster with Stand-off 36" Daisy Chain Light
701739-SAOX1	UltraBRITE Integrated Controller 9 LED Cluster Lamp
701861-9-P	UltraBRITE 9 LED Mini Cluster Lamp
LiquaLED Controllers	
701678-DLO	LiquaLED Controller, Control 40
701898-DLO	LiquaLED Multi-Zone Controller
701931-DLO	LiquaLED Controller, Control 20
Bullet Lights	
701564-1-F	Single-LED Cable Bullet Light, 50"
701564-2-F	Dual-LED Cable Bullet Light, 50"
701564-4-F	Quad-LED Cable Bullet Light, 50"
701564-4-F-XL	Extended Length Quad-LED Cable Bullet Light, 78"
Misc Accessories	
400338	Nut, 3/8, Nylon Hex, Fits All Lens styles
400372	Standard Flange Bullet Lens
400372-KIT	Includes: (5)400338, (5)400372, and (5)400417(kit not shown)
400372-RND	Large Round Lens (1" diameter)
400372-RND-KIT	Includes: (5)400338, (5)400372-RND, and (5)400417(kit not shown)
400417	O-Ring - 0.070"
410117-24-O	2' Jumper Cable w/overmold
410117-60-O	5' Jumper Cable w/overmold

Tailpieces - 1.5" Heaters



**42-0015-K
Tailpiece**
1.5" MBT x 1.5" Soc



**42-0015D-K
Tailpiece**
1.5" MBT x 1.5"
Spig



**42-0023-K
Tailpiece**
1.5" MBT x 1.25" Soc

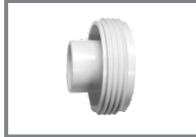

**42-0031-A-K
Tailpiece**
1.5" MBT x 1" Spig



**42-0031-K
Tailpiece**
1.5" MBT x 1" Soc



**42-0031F-K
Tailpiece Offset**
1.5" MBT x 1" Soc



**42-0031F-A-K
Tailpiece Offset**
1.5" MBT x 1" Spig



**42-0015C-K
Tailpiece Offset**
1" Spig x 32 mm

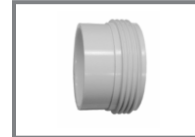

**42-0015A-K
Tailpiece**
1.5" MBT x 50mm Soc

Tailpieces - 2" Heaters



**42-0006A-K
Tailpiece**
2" MBT x 2" Soc Short



**42-0017A-K
Tailpiece**
2" MBT x 2" Spig
Short



**42-0017-K
Tailpiece**
2" MBT x 2" Spig/1.5"
Soc



**42-0016-K
Tailpiece**
2" MBT x 1.5" Soc



**42-0006-T-K
Tailpiece**
2" MBT x 2" No
Groove



**42-2387-K
Tailpiece**
2" MBT x 1" 90° barb



**42-2391-K
Tailpiece**
2" MBT x .75" 90°
barb

Tailpieces - 3" Heaters



**42-2373-K
Tailpiece**
3" MBT x 2" Soc



**42-2384-K
Tailpiece**
3" MBT x .75"
straight barb



**42-2390-K
Tailpiece**
3" MBT x .75" 90°
barb



**42-2380-K
Tailpiece**
3" MBT x 1"
straight barb



**42-2386-K
Tailpiece**
3" MBT x 1" 90° Barb



**42-2392-K
Tailpiece**
3" MBT x 1" 90° Soc

Reducer Bushings



**42-0022-K
Reducer Bushing**
1" Spig x 0.75" FIPT



**42-0018-K
Reducer Bushing**
1" Spig x .75" Soc



**42-0001-K
Reducer Bushing**
2" Spig x 1.5" Spig x
Soc

Pump Unions

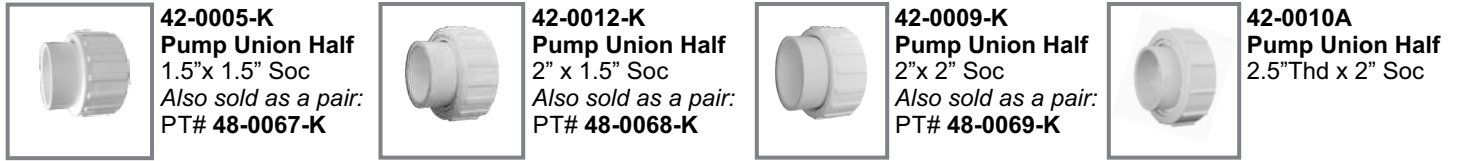

Union Assemblies



Valves



Elbows

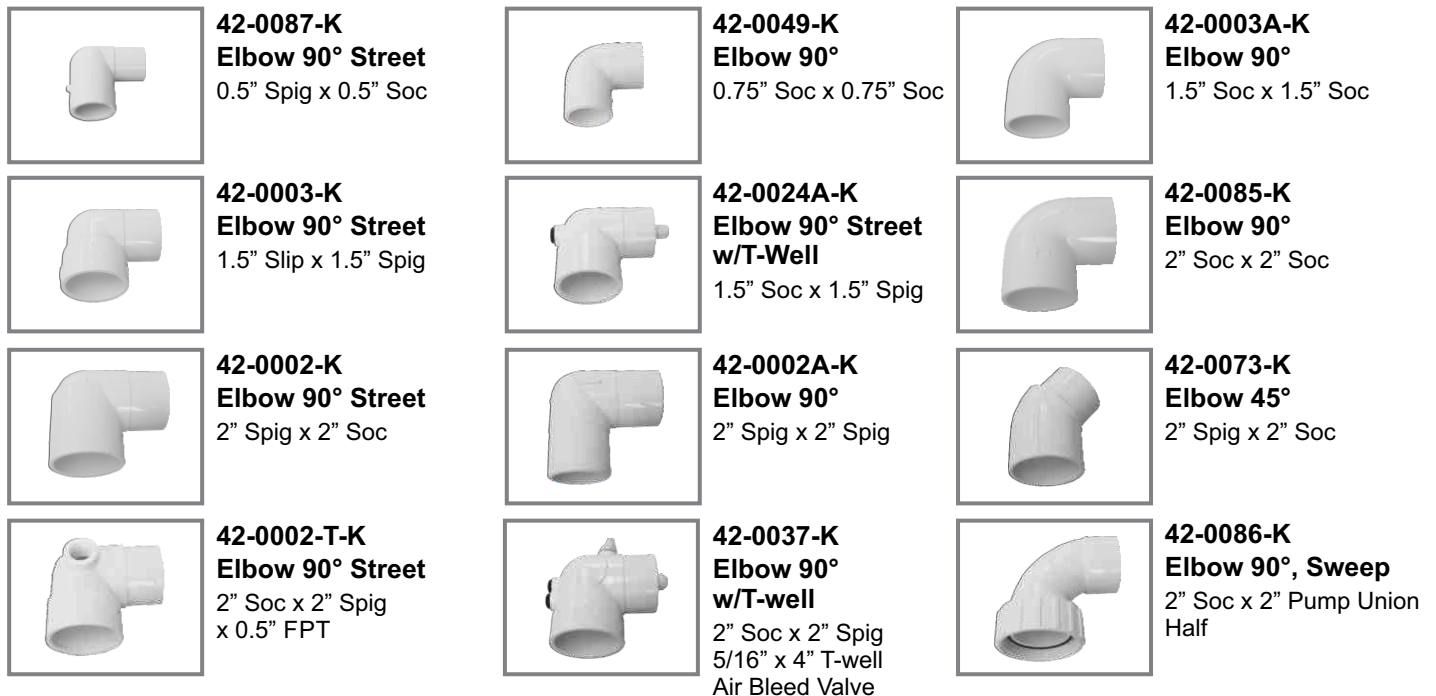

Adapters



Tees, Fittings, Misc PVC Parts



**42-0047-K
Tee**
2" Soc x 2" Soc
x 0.5" FPT



**42-0047-T-K
Tee**
2" MBT x 2" Spig
x 0.5" FPT



**42-0117-K
Tee**
1.5" SLP x 1.5" SLP
x 1.5" SLP



**42-0004-K
Hi-Flo Suction**
1.5" Soc

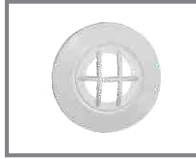

**42-0074A-K
Drain Wall Fitting
w/Grate Assy**
1.5" FBT x 1.5" Soc



**42-0074-K
Auto-Fill
Wall Fitting,
Slotted Return**



**42-0116-K
Ozone Manifold**
1.5" Soc x 1.5" Soc



**42-0088-K
Coupling**
0.5" Soc x 0.5" Soc

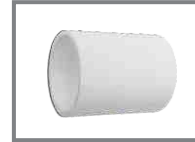

**42-0022B-K
Coupling**
1.5" Soc x 1.5" Soc

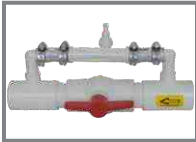

03 Manifold Kit
49-0420A-K - 1 1/2"
49-0421-K - 2"
49-0422-K - 2 1/2"

Nuts, Gaskets



**Split Nut
w/Screws**
Sold in pairs:
48-0082-K - 1.5"
48-0096-K - 2"



**Uni-Nut
w/ Retainer**
Sold in pairs:
42-2334-K - 1.5"
42-2334A-K - 2"
42-2334B-K - 3"



Snap Nuts
Sold in pairs:
48-0074-K - 1.5"
48-0095-K - 2"



**Ridged
Gaskets**
60-0017-K - 1.5"
60-0015-K - 2"
60-0020-K - 3"



**60-0016-K
Flat Gasket**
2"

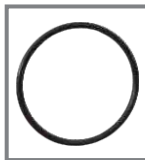

**60-0001-K
O-Ring**
Heater,
5X5 Flanged

Wood Hot Tub Fittings and Accessories



**42-10-5470BRN
Slimline Jet Assy**
1" x 1"
Hole Size - 1 11/16"



**42-10-5671BRN
Slimline Jet Assy**
1" x 0.5"
Hole Size - 1 11/16"



**42-30-6104
Slimline Straight
Nut**



**42-30-3807
Standard Nut**



**25-0002-LG
Front Access Wall
Fitting Light Kit**



PART NUMBER DESCRIPTION

Laing Circulation Pumps

10-0126-K	Laing Circ, E-3, .5" Barbed, 100-240V, 50/60HZ, Watkins®, 70" Cord w/Nema Plug
10-0102-K	Laing Circ, E-5, .75" Barbed, 100-240V, 50/60HZ, Watkins®, 48" Cord, 74427
10-0120-K	Laing Circ, E-10, .75" Barbed, 120V, 50/60HZ, 48" Cord, 73989
10-0120M-K	Laing Circ, E-10, .75" Barbed, 120V, 50/60HZ, 48" Cord, Sundance 6500-460
10-0121-K	Laing Circ, E-10, .75" Barbed, 240V, 50/60HZ, 48" Cord, 73979
10-0121M-K	Laing Circ, E-10, .75" Barbed, 240V, 50/60HZ, 48" Cord, Sundance 6000-125
10-0121FS-K	Laing Circ, E-10, .75" Barbed, 240V, 50/60HZ, 19" Cord, with Flow switch
10-0121-A-K	Laing Circ, E-10, .75" Barbed, 240V, 50/60HZ, 19" Cord, w/o Flow Control, D1
10-0122-K	Laing Circ, E-10, 1" Barbed, 120V, 50/60HZ, 48" Cord, 74069
10-0123-K	Laing Circ, E-10, 1" Barbed, 240V, 50/60HZ, 48" Cord, 74079
10-0124-K	Laing Circ, E-10, .75" Threaded, 120V, 50/60HZ (not shown), 48" Cord, 74009
10-0125-K	Laing Circ, E-10, .75" Threaded, 240V, 50/60HZ (not shown), 48" Cord, 73999
10-0107-K	Laing Circ, E-14, 1.5" Threaded, 240V, 50/60HZ, 48" Cord, 73348

Grundfos Pumps

10-0134	Pump, Grundfos Circ, Series 43, 115V, 60Hz, 1" Barbed, 59896291*
10-0135	Pump, Grundfos Circ, Series 43, 230V, 60Hz, 1" Barbed, 59896292*
10-0138-K	Pump, Grundfos Circ, 230V, 60Hz, 3/4" Barbed
10-0138-KIT	Pump, Grundfos Circ, 230V, 60Hz, 3/4" Barbed, Universal Kit
10-0139-K	Pump, Grundfos Circ, 115V, 60Hz, 3/4" Barbed
10-0139-KIT	Pump, Grundfos Circ, 115V, 60Hz, 3/4" Barbed, Universal Kit

Pumps & Parts

10-0111	Replaced with 10-0139-K
10-0111A	Replaced with 10-0138-K
10-0110	Replaced with 10-0265-4A4-K
10-0110A	Replaced with 10-0265-4A3-K
10-0265-4A4-K	Pump, 120V, 1SPD, 1/8HP
10-0265-4A3-K	Pump, 230V, 1SPD, 1/8HP
993-0262A-L48-S	Pump, 120V, 1SPD, 0.5HP, 7.5A, Molded Plug
993-0262A-A48-S	Pump, 120V, 1SPD, 0.5HP, 7.5A, AMP Plug
48-0310-K	Adapter, Pump, Tubing Step Down Kit, from 1" to 3/4"
42-0070A-K	Pump, Leaf Trap, 1.5"X1.5", Kit

* Also replaces Series 38



PART NUMBER DESCRIPTION

48 Frame Spa Pump (2" Suction / 2" Discharge)	
10-0215-3M	Pump, 1.0HP, 2SPD, 120V, 8.8/2.6A, 60Hz, Side Discharge
10-0207	Pump, 1.5HP, 1SPD, 230V, 7.5A, 60Hz, Side Discharge
10-0203-3M	Pump, 1.5HP, 2SPD, 115V, 11/2.9A, 60Hz, Side Discharge
10-0206	Pump, 2.0HP, 1SPD, 120/230V, 20/10A, 60Hz, Side Discharge
10-0204-3M	Pump, 2.0HP, 2SPD, 115V, 13.8/3.8, 60Hz, Side Discharge
10-0202-3M	Pump, 2.0HP, 2SPD, 230V, 8/2.6A, 60Hz, Side Discharge
10-0205	Pump, 3.0HP, 1SPD, 230V, 12A, 60Hz, Side Discharge
10-0201-3M	Pump, 3.0HP, 2SPD, 230V, 8.5/2.6A, 60Hz, Side Discharge
10-0200-3M	Pump, 4.0HP, 2SPD, 230V, 10.5/2.8A, 60Hz, Side Discharge
10-0210-3M	Pump, 5.0HP, 2SPD, 230V, 12/3.5A, 60Hz, Side Discharge
56 Frame Self Priming Pump (2" Suction / 2" Discharge)	
11-0003	Replaced by 11-48SUP1502-WW (see page 70)
11-0002	Replaced by 11-48SUP2002-WW (see page 70)
Baptistry Pump (1.5" Suction / 1.5" Discharge)*	
993-0262A-L48-S	Pump, 120V, 1SPD, 1/2HP, 48" Molded Cord
993-0380-A6-S	Pump, 115V, 1SPD, Amp Pigtail Cord
993-0380A-A6-S	Pump, 230V, 1SPD, Amp Pigtail Cord
10-0178-S	Pump, Submersible, 1/6HP, 120V
Bath Pumps, Full Drain (1.5" Suction / 1.5" Discharge)	
10-0262A	Pump, Full Drain, 1/2HP, 1SPD, 120V, 3' cord w/Nema, 3Pt Mount
10-1010031-K	Pump, Full Drain 120V, 1SPD, 5.5A
10-1010032-K	Pump, Full Drain 120V, 1SPD, 7.5A
10-1011057-K	Pump, Full Drain 120V, 1SPD, 9A
10-1034002-K	Pump, Full Drain 120V, 1SPD, 13A

U.S. Pump Seals

Basic Service				Premier Viton Service			
PT#	Size	Head*	Seat**	PT#	Size	Head*	Seat**
10-PS100	5/8"	A	1	N/A			
10-PS1000	5/8"	B	1	10-PS3865R	5/8"	B	1
10-PS200	5/8"	A	1	10-PS3867	5/8"	G	1
10-PS201	3/4"	A	1	10-PS3868	3/4"	G	1
10-PS2131	5/8"	A	31	10-PS3869	5/8"	B	31

*Head Type:



**Seat Type:





PART# DESCRIPTION

Jet Pumps 48 & 56 Frame

10-48WUA1001	Pump, LX, 1.0HP, 2SPD, 115V, 3.8A/10.3A, 48WUA1001C-II, 2"
10-48WUA1501	Pump, LX, 1.5HP, 2SPD, 115V, 3.8A/13.8A, 48WUA1501C-II, 2"
10-48WUA1502	Pump, LX, 1.5HP, 2SPD, 230V, 2.6A/8.0A, 48WUA1502C-II, 2"
10-48WUA151-NF1	Pump, LX, 1.5HP, 1SPD, 115V, 13.8A, 48WUA1501C-I, 2", NO FRAME
10-48WUA151-NF2	Pump, LX, 1.5HP, 2SPD, 115V, 3.8A/13.8A, 48WUA1501C-II, 2", NO FRAME
10-48WUA2002	Pump, LX, 2.0HP, 2SPD, 230V, 3.0A/10A, 48WUA2002C-II, 2"
10-48WUA202-NF1	Pump, LX, 2.0HP, 1SPD, 230V, 10A, 48WUA2002C-I, 2", NO FRAME
10-48WUA202-NF2	Pump, LX, 2.0HP, 2SPD, 230V, 3.0A/10A, 48WUA2002C-II, 2", NO FRAME
10-56WUA300	Pump, LX, 3.0HP, 2SPD, 230V, 3.5A/10A, 56WUA300-II, 2"
10-56WUA400	Pump, LX, 4.0HP, 2SPD, 230V, 4.4A/12A, 56WUA400-II, 2"
10-56WUA300A	Pump, LX, 3.0HP, 2SPD, 230V, 3.5A/10A, 56WUA300A-II, 2.5"
10-56WUA400A	Pump, LX, 4.0HP, 2 SPD, 230V, 4.4A/12A, 56WUA400A-II, 2.5"
10-56WUA500A	Pump, LX, 5.0HP, 2 SPD, 230V, 5.0A/15A, 56WUA500A-II, 2.5"

Jet Pumps 56 Frame - Brackeless

10-56WUA400-NF2	Pump, LX, 4.0HP, 2 SPD, 230V, 4.4A/12A, 56WUA400-II Bracketless, 2"
10-56WUA400-NF1	Pump, LX, 4.0HP, 1 SPD, 230V, 12A, 56WUA400-I Bracketless, 2"

Self Priming Spa Pumps 56 Frame

11-56SFP200	Pump, LX, 56SFP, 2.0HP, 2SPD, 230V, 2.3A/6.6A, 56SFP200-II, W/Basket, 2"
11-56SFP250	Pump, LX, 56SFP, 2.5HP, 2SPD, 230V, 3.0A/8.0A, 56SFP250-II, W/Basket, 2"
11-56SFP300	Pump, LX, 56SFP, 3.0HP, 2SPD, 230V, 3.5A/10A, 56SFP300-II, W/Basket, 2"
11-56SFP350	Pump, LX, 56SFP, 3.5HP, 2SPD, 230V, 3.5A/11A, 56SFP350-II, W/Basket, 2"
11-48SUP1002	Pump, LX, 48SUP, 2.0HP, 2SPD, 230V, 2.0A/5.2A, 48SUP1002C-II, W/Basket, 2"
11-48SUP1502	Pump, LX, 48SUP, 2.5HP, 2SPD, 230V, 2.6A/8.0A, 48SUP1502C-II, W/Basket, 2"
11-48SUP2002	Pump, LX, 48SUP, 3.0HP, 2SPD, 230V, 3.0A/10A, 48SUP2002C-II, W/Basket, 2"
11-56SWP200	Pump, LX, 56SWP, 2.0HP, 2SPD, 230V, 3.0A/8.0A, 56SWP200-II, W/Basket, 2"
11-56SWP300	Pump, LX, 56SWP, 3.0HP, 2SPD, 230V, 3.5A/10A, 56SWP300-II, W/Basket, 2"
11-56SWP400	Pump, LX, 56SWP, 4.0HP, 2SPD, 230V, 4.4A/12A, 56SWP400-II, W/Basket, 2"
11-56SWP500	Pump, LX, 56SWP, 5.0HP, 2SPD, 230V, 5.0A/15A, 56SWP500-II, W/Basket, 2"

Circulation Pumps

10-WE14-240V	Pump, LX, WE14, 240V, 60Hz
10-WE14-120V	Pump, LX, WE14, 120V, 60Hz
10-WE10-240V	Pump, LX, WE10, 240V, 60Hz
10-WE10-120V	Pump, LX, WE10, 120V, 60Hz
10-48WTC0153	Pump, LX, CIRC, 1/15HP, 1SPD, 115/230V, 1.6A/0.7A, 48WTC0153C-1, 1.5"

Bath Pumps

10-WCA50	Pump, LX, BATH, .5HP, 1 SPD, 120V, 4A, WCA50, 1.5"
10-WCA75	Pump, LX, BATH, .75HP, 1 SPD, 120V, 5A, WCA75, 1.5"
10-WCA100	Pump, LX, BATH, 1HP, 1 SPD, 120V, 7A, WCA100, 1.5"



PART# DESCRIPTION

Spa Pumps

10-4154213	Pump, BWG, Jacuzzi, 115V, 2HP, 2Spd, 13.6/3.6A, 2"
10-4234211	Pump, BWG, Jacuzzi, 240V, XHP, 2Spd, 11/3.3A, 2"
10-4239110	Pump, BWG, Dura Jet, 115V, 1HP, 2Spd, 10.4/3.6A, 2"
10-4239113	Pump, BWG, Dura Jet, 115V, 2HP, 2Spd, 13/3.7A, 2"
10-4239207	Pump, BWG, Dura Jet, 230V, 1HP, 2Spd, 7.2/2.4A, 2"
10-4239208	Pump, BWG, Dura Jet, 230V, 2HP, 2Spd, 8.5/3A, 2"
10-4239210	Pump, BWG, Dura Jet, 230V, 2.5HP, 2Spd, 10.7/3A, 2"
10-5235208	Pump, BWG, Ultimax, 230V, 2.5HP, 2Spd, 10.7/3A, 2"
10-5235210	Pump, BWG, Ultimax, 230V, 3HP, 2Spd, 10/3.5A, 2"
10-5235212	Pump, BWG, Ultimax, 230V, 4HP, 2Spd, 12/3.5A, 2"
10-5235216	Pump, BWG, Ultimax, 230V, 5HP, 2Spd, 16.4/4.8A, 2"
10-7154213	Pump, BWG, Power Wow, 230V, 3HP, 6A, 2"

Circulation Pumps

10-6154106	Pump, BWG, Circulation, Wow, 230V, 1/15HP, 0.6A, 1.5"
10-6154113	Pump, BWG, Circulation, Wow, 115V, 1/15HP, 1.3A, 1.5"
10-6154116	Pump, BWG, Circulation, Olympian, 115V, 1/12HP, 1.6A, 1.5"



Bath Pumps, Full Drain (1.5" Suction / 1.5" Discharge)

10-1010031-K	Pump, BWG, Full Drain 120V, 1SPD, 5.5A
10-1010032-K	Pump, BWG, Full Drain 120V, 1SPD, 7.5A
10-1011057-K	Pump, BWG, Full Drain 120V, 1SPD, 9A
10-1034002-K	Pump, BWG, Full Drain 120V, 1SPD, 13A

Ultima



Ultima Plus



Ultimax



Dura Jet



Wet End Features:

- Viton Seal
- Individually Boxed
- Assembly Instructions Included
- Union O-Rings Provided



Ultima

HQ PT#	BWG PT#	HP	SIZE	DISCHARGE	FRAME	MIN AMPERAGE*	
						120V	240V
10-0162-HQ	1215156	.75	1.5"S x 1.5"D	SIDE	48Y	9+	N/A
10-0163-HQ	1215158	.75	1.5"S x 1.5"D	CENTER	48Y	9+	N/A
10-0164-HQ	1215116	1.0	1.5"S x 1.5"D	SIDE	48Y	10.3+	N/A
10-0165-HQ	1215009/1215117	1.0	2"S x 2"D	SIDE	48Y	10.3+	N/A
10-0166-HQ	1215119	1.0	1.5"S x 1.5"D	CENTER	48Y	10.3+	N/A
10-0167-HQ	1215120/1215121	1.5	1.5"S x 1.5"D	SIDE	48Y	13.6+	7+
10-0168-HQ	1215123	1.5	2"S x 2"D	SIDE	48Y	13.6+	7+
10-0169-HQ	1215128	1.5	1.5"S x 1.5"D	CENTER	48Y	13.6+	7+
10-0170-HQ	1215129	2.0	1.5"S x 1.5"D	SIDE	48Y	N/A	8.0+
10-0171-HQ	N/A	1.5	2"S x 2"D	CENTER	48Y	13.6+	7+
10-0172-HQ	1215132	2.0	2"S x 2"D	SIDE	48Y	N/A	8.0+
10-0173-HQ	1215131	2.0	2"S x 1.5"D	SIDE	48Y	N/A	8.0+
10-0174-HQ	N/A	2.0	2"S x 1.5"D	CENTER	48Y	N/A	8.0+
10-0175-HQ	N/A	2.0	2"S x 2"D	CENTER	48Y	N/A	8.0+
10-0176-HQ	1215129	2.0	1.5"S x 1.5"D	CENTER	48Y	N/A	8.0+

Ultima Plus

HQ PT#	BWG PT#	HP	SIZE	DISCHARGE	FRAME	MIN AMPERAGE*	
						120V	240V
10-0152-HQ	1215161	2.0	2"S x 2"D	SIDE	48Y	13.6+	7+
10-0153-HQ	1215145	3.0	2"S x 2"D	SIDE	48Y	N/A	8+

Ultimax

HQ PT#	BWG PT#	HP	SIZE	DISCHARGE	FRAME	MIN AMPERAGE*	
						120V	240V
10-0181-HQ	N/A	1.5	2"S x 2"D	SIDE	15Y	N/A	6.7+
10-0182-HQ	1215010/1215160	1.5	2"S x 2"D	SIDE	48Y/56Y	N/A	6.7+
10-0183-HQ	1215185/1215055	2.0	2"S x 2"D	SIDE	48Y/56Y	N/A	8.8+
10-0185-HQ	N/A	2.5	2"S x 2"D	SIDE	48Y/56Y	N/A	10+
10-0186-HQ	1215186/1215060	3.0	2"S x 2"D	SIDE	48Y/56Y	N/A	12+
10-0187-HQ	1215036/1215062	3.0	2.5"S x 2"D	SIDE	48Y/56Y	N/A	12+
10-0188-HQ	1215007/1215187	4.0	2"S x 2"D	SIDE	48Y/56Y	N/A	16+
10-0189-HQ	1215045	4.0	2.5"S x 2"D	SIDE	48Y/56Y	N/A	16+

Dura Jet

HQ PT#	BWG PT#	HP	SIZE	DISCHARGE	FRAME	MIN AMPERAGE*	
						120V	240V
10-0190-HQ	1215022	1.0	2"S x 2"D	SIDE	48Y/56Y	10.3+	5.5+
10-0192-HQ	1215023	1.5	2"S x 2"D	SIDE	48Y/56Y	13.6+	7+
10-0194-HQ	1215014	2.0	2"S x 2"D	SIDE	48Y/56Y	N/A	8+
10-0196-HQ	1215033	2.5	2"S x 2"D	SIDE	48Y/56Y	N/A	10+
10-0197-HQ	1215015	3.0	2"S x 2"D	SIDE	48Y/56Y	N/A	12+

S = Suction D = Discharge

*MIN AMPERAGE: Some wet ends require the motor to have a minimum amperage rating. This is to avoid overheating the motor. The amperage rating of the motor can be read from the label on the motor showing amp draw for both low and high speed in the case of a two speed motor.

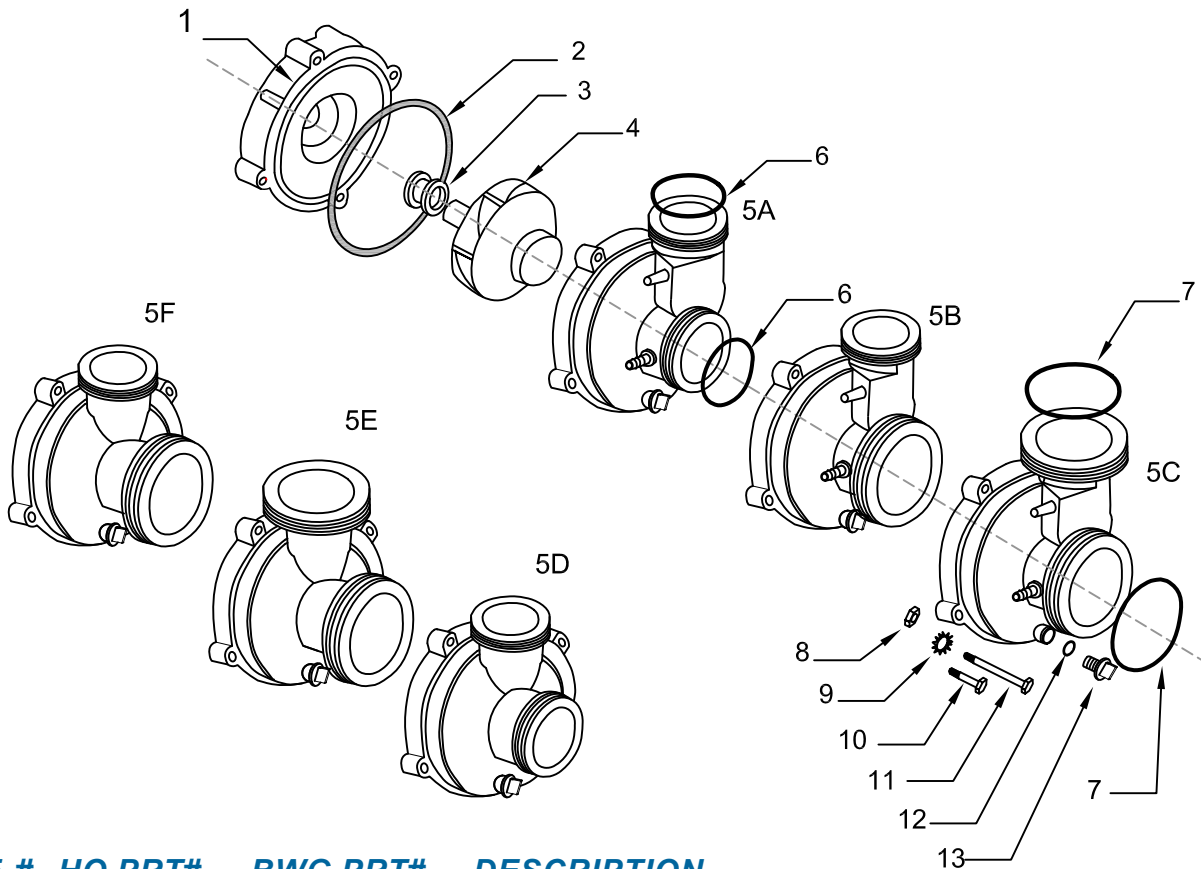

REF. # HQ PRT# BWG PRT# DESCRIPTION

REF. #	HQ PRT#	BWG PRT#	DESCRIPTION
1	15-0045A	1211008	Pump, Seal Plate
2	60-0010-K	6020022	O-Ring, Pump Volute, Ultima
3	10-PS3868	N/A	Pump, Viton Seal Assy
4A	15-0059	1212120	Pump, Impeller 230V H/F Circ.
4C	15-0050	1212203	Pump, Impeller 3/4HP Ultima
4D	15-0051	1212205	Pump, Impeller 1.0HP Ultima
4E	15-0052	1212215	Pump, Impeller 1.5HP Ultima
4H	15-0053-K	1212218	Pump, Impeller 2.0HP Ultima
5A	15-0046	1210017	Pump, Volute 1.5"X1.5" Side
5B	15-0055	1210015	Pump, Volute 1.5"X2" Side
5C	15-0057	1210014	Pump, Volute 2"X2" Side
5D	15-0049	1210016	Pump, Volute 1.5"X1.5" Center
5E	15-0058	1210013	Pump, Volute 2"X2" Center
5F	15-0056	N/A	Pump, Volute 1.5"X2" Center
6	60-0005	N/A	O-Ring, 1.5" Pump Union
7	60-0011	N/A	O-Ring, 2" Pump Union
8	01-0005	N/A	Nut, 1/4-20 Hex Zinc
9	03-0017	N/A	Washer, 1/4" Star Zinc
10	02-0100	N/A	Bolt, 1/4-20 X 1.5", Zinc
11	02-0101	N/A	Bolt, 1/4-20 X 2.75", Zinc
12	60-0010C	0-112B70	O-Ring, Drain Plug
13	15-0036A	1214138	Plug, Pump Volute

Ultima Wet End Assemblies

Part #	Description
10-0162-HQ	0.75HP, 1.5"X1.5" Side
10-0163-HQ	0.75HP, 1.5"X1.5" Center
10-0164-HQ	1.0HP, 1.5"X1.5" Side
10-0165-HQ	1.0HP, 2"X2" Side
10-0166-HQ	1.0HP, 1.5"X1.5" Center
10-0167-HQ	1.5HP, 1.5"X1.5" Side
10-0168-HQ	1.5HP, 2"X2" Side
10-0169-HQ	1.5HP, 1.5"X1.5" Center
10-0170-HQ	2HP, 1.5"X1.5" Side
10-0171-HQ	1.5HP, 2"X2" Center
10-0172-HQ	2HP, 2"X2" Side
10-0173-HQ	2HP, 1.5"X2" Side
10-0174-HQ	2HP, 1.5"X2" Center
10-0175-HQ	2HP, 2"X2" Center
10-0176-HQ	2HP, 1.5"X1.5" Center

Please refer to page 8.30 for a complete list of Wet Ends

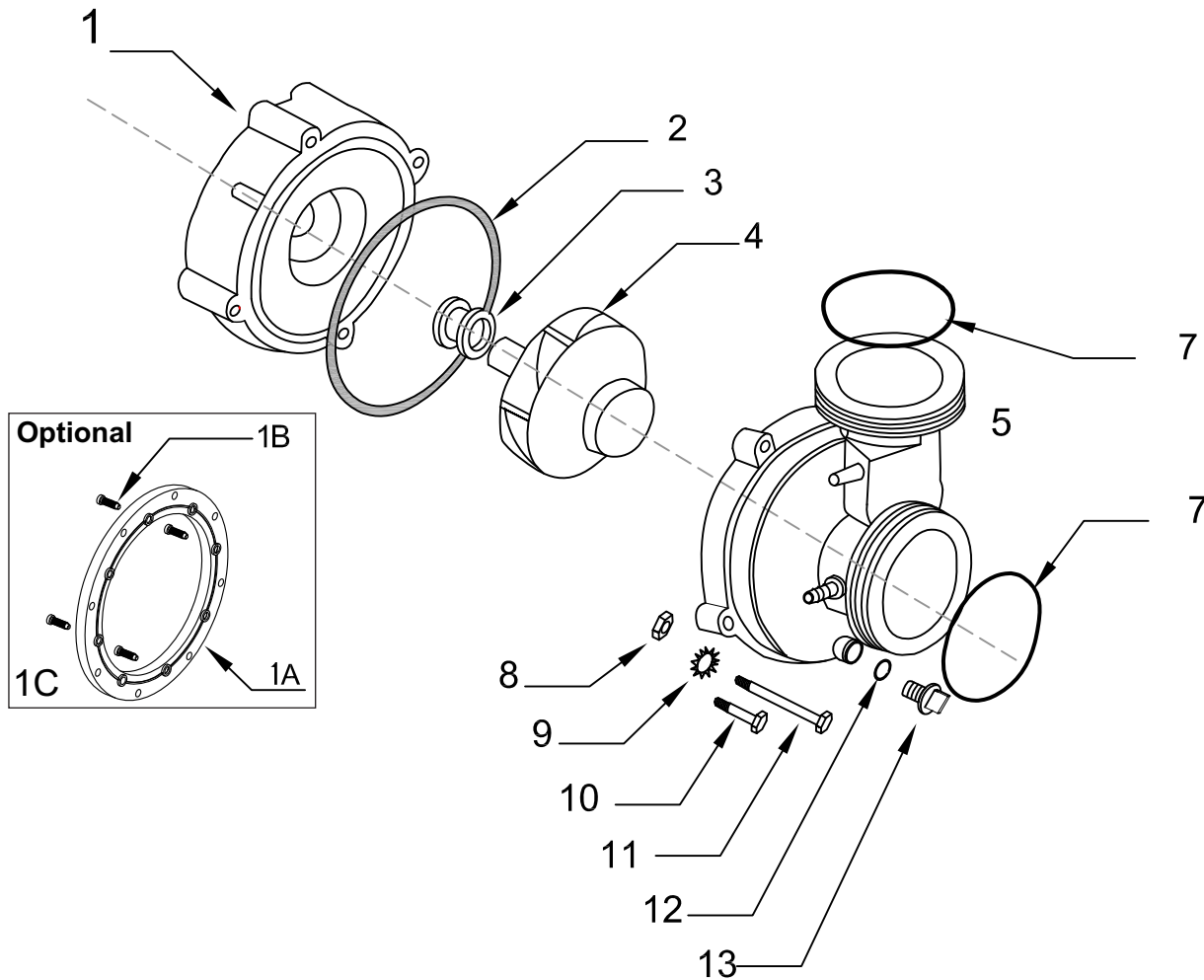

REF. #	HQ PRT#	BWG PRT#	DESCRIPTION
1	15-0061A	1211009	Pump, Seal Plate No Seal, Ultima Plus
1A	15-0089	1217179	Bracket, Pump GE MTR, 48/56F (not included)
1B	02-0053A	N/A	Machine Screw, 8-32 x 3/8", Stainless Steel
1C	48-0202-K	N/A	BWG Pump Bracket w/hardware, Kit
2	60-0010-K	6020022	O-Ring, Pump Volute
3	10-PS3868	N/A	Pump, Viton Seal Assy
4A	15-0052C	1212185	Pump, Impeller 1.5HP Ultima Plus
4D	15-0053C	1212225	Pump, Impeller 2.0HP Ultima Plus
4E	15-0060C-K	1212221	Pump, Impeller 3.0HP Ultima Plus
5	15-0062	1210036	Pump, Volute 2"X2" Side Ultima Plus
7	60-0011	N/A	O-Ring, 2" Pump Union
8	01-0005	N/A	Nut, 1/4-20 Hex Zinc
9	03-0017	N/A	Washer, 1/4" Star Zinc
10	02-0100	N/A	Bolt, 1/4-20 X 1.50", Zinc
11	02-0101	N/A	Bolt, 1/4-20 X 2.75", Zinc
12	60-0010C	0-112B70	O-Ring, Drain Plug
13	15-0036A	1214138	Plug, Pump Volute

Ultima Plus Wet End Assemblies

Part #	Description
10-0152-HQ	2.0HP, 2"X2" Side
10-0153-HQ	3.0HP, 2"X2" Side

Please refer to page 8.30 for a complete list of Wet Ends

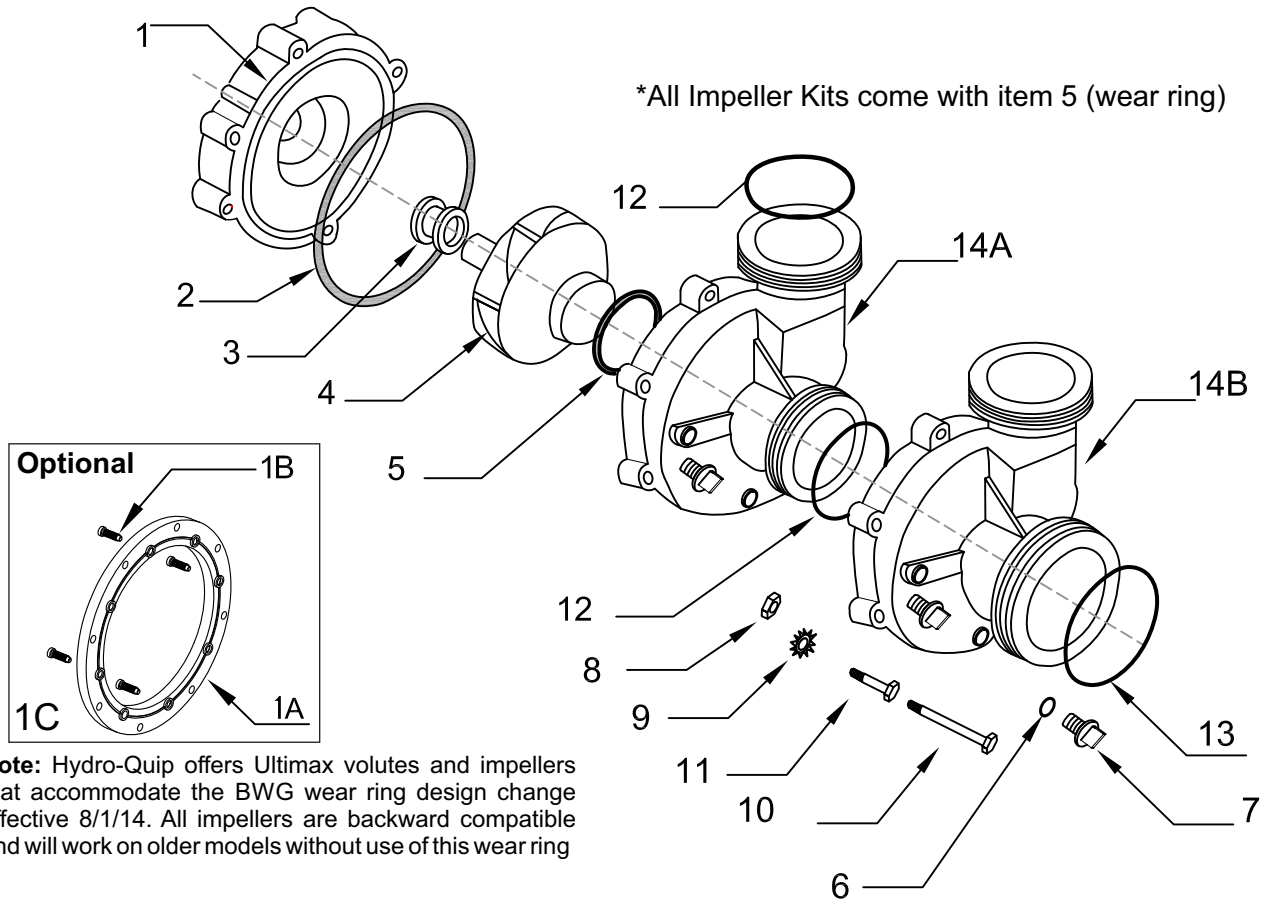

Note: Hydro-Quip offers Ultimax volutes and impellers that accommodate the BWG wear ring design change effective 8/1/14. All impellers are backward compatible and will work on older models without use of this wear ring

REF. #	HQ PRT#	BWG PRT#	DESCRIPTION
1	15-0067	1211027	Pump, Back Seal Plate Ultimax
1A	15-0089	1217179	Bracket, Pump GE MTR, 48/56F (not included)
1B	02-0053A	N/A	Machine Screw, 8-32 x 3/8", Stainless Steel
1C	48-0202-K	N/A	BWG Pump Bracket w/hardware, Kit
2	60-0010A-K	0-163E70	O-Ring, Pump Volute Ultimax
3	10-PS3868	N/A	Pump, Viton Seal
4A*	15-0052B1-K	1212227/1212350	Pump, Impeller 1.0HP Ultimax, Power Wow
4B*	15-0052B-K	1212223/1212243	Pump, Impeller 1.5HP Ultimax
4C*	15-0053B-K	1212230/1212354	Pump, Impeller 2.0HP Ultimax
4D*	15-0054B-K	1212355	Pump, Impeller 2.5HP Ultimax
4E*	15-0060B-K	1212234/1212235/ 1212360	Pump, Impeller 3.0HP Ultimax
4F*	15-0064B-K	1212008/1212375	Pump, Impeller 4.0HP Ultimax
5	15-0066	1213050	Pump, Wear Ring Ultimax
6	60-0010C	0-112B70	Pump, O'Ring Drain Plug
7	15-0036A	1214138/1214140	Pump, Plug Volute Ultimax
8	01-0005	N/A	Nut, 1/4-20 Hex, Zinc
9	03-0017	N/A	Washer, 1/4" Star Zinc
10	02-0101	N/A	Bolt, 1/4-20 -2.75", Zinc
11	02-0100	N/A	Bolt, 1/4-20 -1.5", Zinc
12	60-0011	N/A	O-Ring, 2" Pump Union
13	60-0011A	0-234B70	O-Ring, 2.5" Pump Union
14A	15-0068	1210050	Pump, Volute 2"X2" Suction
14B	15-0068A	1210051	Pump, Volute 2"X2.5" Suction

Ultimax Plus Wet End Assemblies

Part #	Description
10-0181-HQ	1.5HP, 2"X2" Side, Power Wow
10-0182-HQ	1.5HP, 2"X2" Side
10-0183-HQ	2.0HP, 2"X2" Side
10-0185-HQ	2.5HP, 2"X2" Side
10-0186-HQ	3.0HP, 2"X2" Side
10-0187-HQ	3.0HP, 2"X2.5" Side
10-0188-HQ	4.0HP, 2"X2" Side
10-0189-HQ	4.0HP, 2"X2.5" Side

Please refer to page 8.30 for a complete list of Wet Ends

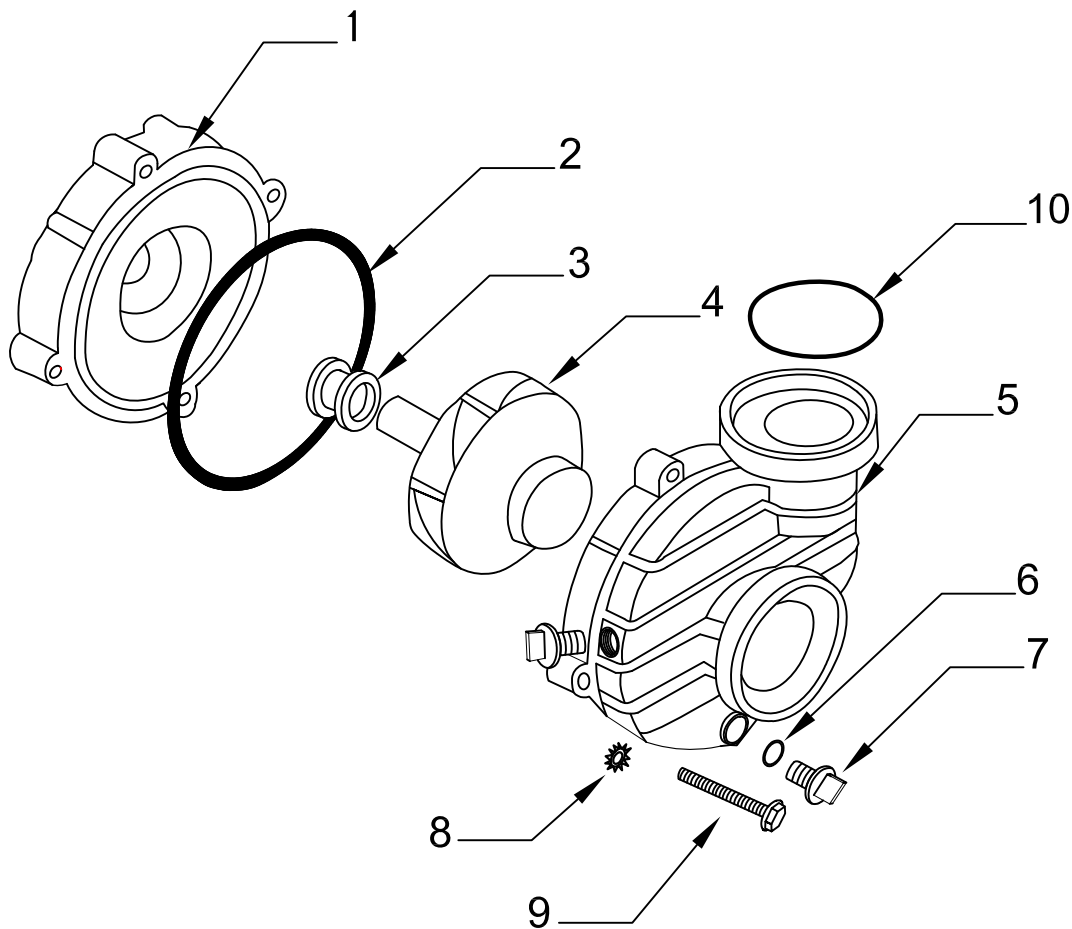

REF. #	HQ PRT#	BWG PRT#	DESCRIPTION
1	15-0044A	17400-0003	Pump Seal Plate With Nuts
2	60-0010B-K	6020026	O-Ring, Volute DJ
3	10-PS3868	N/A	Pump, Viton Seal Assy
4A	15-0051A	17400-0120	Pump Impeller 1.0 HP
4C	15-0052A	17400-0121	Pump Impeller 1.5 HP
4E	15-0053A	17400-0122	Pump Impeller 2.0 HP
4F	15-0054A	17400-0123	Pump Impeller 2.5 HP
4G	15-0060A-K	17400-0135	Pump Impeller 3.0 HP
5	15-0043	17400-0108	Pump, Volute 2"x2" Side
6	60-0010C	0-112B70	O-Ring, Drain Plug
7	15-0036A	1214138	Plug, Pump Volute
8	03-0017	N/A	Washer 1/4" Star Zinc
9	02-0100	N/A	Bolt, 1/4-20 -1.5 Hex Head, Zinc
10	60-0011	N/A	O-Ring 2" Pump Union

Dura Jet Wet End Assemblies

Part #	Description
10-0190-HQ	1.0HP, 2"x2" Side
10-0192-HQ	1.5HP, 2"x2" Side
10-0194-HQ	2.0HP, 2"x2" Side
10-0196-HQ	2.5HP, 2"x2" Side
10-0197-HQ	3.0HP, 2"x2" Side

Please refer to page 8.30 for a complete list of Wet Ends



PART NUMBER DESCRIPTION

12-0100-K	Heater Element, 5.5kW, 240V, 10" Incoloy
12-0100D-K	Heater Element, 5.5kW, 240V, 7" Incoloy
12-0100F-K	Heater Element, 5.5kW, 240V, 10" Titanium
12-0110G-K	Heater Element, 5.5kW, 240V, 7" Titanium
15-0033**	Base, 9X9, PBS/BES55-11
15-0033B**	Base, 9X9, BES 55/11
15-0037D**	Base, 14.5"X15", BES, 6000
26-0071-BAP-K***	Heater Assy, BCS/BES6000, 2.25", 5.5kW, Baptisma
26-0071-BAP-FA	Heater Assy, BCS/BES6000, 2.25", 5.5kW, Baptisma
42-0004-K	Drain, Suction/Return, 1.5"
42-0004A-K	Drain, Floor, 2" w/PVC Grid
42-0005-K	Pump Union, 1.5", w/O-Ring
42-0017-K	Tailpiece, 2" Htr X 2" Spig
42-0074-K	Wall Fitting, Slot, Auto-Fill
42-0074A-K	Wall Fitting, Drain, WL/OF
48-0001B	Header Assy for BES-6000/6005, 1.5" x 2", w/Gasket
48-0010C	Header Assy for PBES, w/Gasket
48-0029A	Header Assy for BES-6005, 11kW, heater to heater, Bap/Slide, w/Gasket
48-0072-K	Tailpiece w/Female Hose, 1.5", w/Gasket
48-0072A-K	Tailpiece w/ Male Hose, 1.5", w/Gasket
48-0072B-K	Tailpiece w/Female Hose, 2", w/Gasket
48-0072C-K	Tailpiece w/ Male Hose, 2", w/Gasket
48-0088	Header Assy for BES-6000, 5.5kW, pump to heater, 1.5" x 2", w/Gasket & O-Ring
48-0088A	Header Assy for BES-6005, 11kW, pump to heater, 1.5" x 2", w/Gasket & O-Ring
48-0146-K	Booster Heater Kit, 5.5kW ((Not Shown)
48-P250-PBES-LO	Htr Assy, 1.9", PBES, 2.0W, PSI (Not Shown)
48-P250-PBES-UP	Htr Assy, 1.9", PBES, 2.0W, PSI (Not Shown)
60-0015-K*	Gasket, 2" Ridged
60-0017-K*	Gasket, 1.5" Ridged
60-0020-K*	Gasket, 3" Ridged

***Systems built before 2014



PART NUMBER DESCRIPTION

34-0002-K	Air Switch 125/250V, 25, SPDT
34-0012-K	High Limit, 250V, 30A, 5/16 Bulb, 24" Cap
34-0030-K	Thermostat, 250V, 30A, 5/16 Bulb, 24" Cap
34-0035-K	Timer, 7 Day, 120V, 60HZ, 21A, STD, w/Override Switch
34-0155-K	Pressure Switch, 120V, 5A, 1/8" Thread, For Baptismal Water Level
34-0178-K	Pressure Switch, 120V, 1A, 1/8" Thread, 1.50PSI (adjustable)
35-0003-K	Relay, SPDT, 15A, 240V, T-91
35-0012-K	Contact, DPST, 120V, 30/40A
35-0014-K	Contact, DPST, 120V, 50A
35-0028-K	Contact, DPST, 240V, 40/50A
35-0037-K	Relay, DPST, 30A, 240V, T-92
36-0004A-K	Air Transmitter, White, #15, 1 1/4" Hole Size
36-0006A	Air Transmitter, Chrome, #15, 1 1/4" Hole Size
42-0007B-K	Snap Nut, 2.0", Black
42-2333B-K	Nut, 3", Uni-Nut and Retainer
48-0154	HC GFCI Removal Kit; 2 wire nuts, 2 hole plugs & wiring instructions
64-0001B	Tubing, 1/4" OD X 1/8" ID, Clear
40-0008*	Valve, Ball 1 1/2", PVC
40-0009*	Valve, Ball 2", PVC
40-0010*	Valve, Ball 3/4" SxS, PVC
64-0012	Tubing, Long Distance, 1/8" OD X 1/16" ID, Clear
64-0017	Garden Hose, 15'
993-0262A-A48-S	Pump, Full Drain, 1/2HP, 1SPD, 120V, 3' Amp Cord
993-0262A-L48-S	Pump, Full Drain, 1/2HP, 1SPD, 120V, 48" Molded Cord
993-0380-A6-S	Pump, 115V, 1SPD, Amp Pigtail Cord
993-0380A-A6-S	Pump, 230V, 1SPD, Amp Pigtail Cord
10-0178-S	Pump, Submersible, 1/6HP, 120V
80-0132D-BES	Label, TDI, HQ BES, 3 BTN

CORD PART NO.	DESCRIPTION	WIRE GAUGE	COLOR
30-0180-48-K	Cord, Ozone, Molded, 48"	18/3	 YELLOW
30-0180-96	Cord, Ozone, Molded, 96"	18/3	
30-1180-L6	Adapter Cord, 6", Yel, Ozone Amp to Molded	18/3	
30-1180-L48	Cord, Yel, Ozone Amp to Molded, Univ	18/3	
30-1180-L96	Cord, Yel, Ozone Amp to Molded, Univ	18/3	
09-0018C-A	Receptacle, Ozone, Molded/Colored	18/3	
30-0190-48	Cord, Switched ACC., Molded, 48"	18/3	 LT. VIOLET
30-0190-96	Cord, Switched ACC., Molded, 96"	18/3	
30-0190-30	Cord, Slide, Heater Control (PSI), Molded, 30"	18/3	
30-0190-60VH	Cord, VH, Heater Control (PSI), Molded, 60"	18/3	
09-0019C-A	Receptacle, Switched ACC.,Molded/Colored	18/3	
30-0200-48-K	Cord, Blower, Molded, 48"	18/3	 VIOLET
30-0200-96	Cord, Blower, Molded, 96"	18/3	
30-1200-L6	Adapter Cord, 6", Vio, Blwr Amp to Molded	18/3	
30-1200-L48	Cord, Vio, Blwr Amp to Molded, Univ	18/3	
30-1200-L96-K	Cord, Vio, Blwr Amp to Molded, Univ	18/3	
09-0020C-A	Receptacle, Blower, Molded/Colored	18/3	
30-0210-48-S	Cord, Circ. Pump, Molded, 48"	18/3	 BLUE
30-0210-96-K	Cord, Circ. Pump, Molded, 96"	18/3	
30-1210-L6	Adapter Cord, 6", BL, Circ Amp to Molded	18/3	
30-1210-L48	Cord, BL, Circ Amp to Molded, Univ	18/3	
30-1210-L96	Cord, BL, Circ Amp to Molded, Univ	18/3	
09-0021C-A	Receptacle, Circ, Pump, Molded/colored	18/3	
30-0220-48-K	Cord, Pump 1, 2-Speed, Molded, 48"	14/4	 RED
30-0220-96-K	Cord, Pump 1, 2-Speed, Molded, 96"	14/4	
30-1220-L6	Adapter Cord, 6", Red, P1, 2 Speed Amp to Molded	14/4	
30-1220-L48	Cord, Red, P1, 2 Molded, Univ	14/4	
30-1220A-L48	Cord, Red, P1, 2 Molded, Revrse	14/4	
30-1220-L96	Cord, Red, P1, 2 Molded, Univ	14/4	
09-0022C-A	Receptacle, Pump 1, 2 Speed, Molded/Colored	14/4	
30-0230-48-K	Cord, Pump 2, 2-Speed, Molded, 48"	14/4	 BROWN
30-0230-96-K	Cord, Pump 2, 2-Speed, Molded, 96"	14/4	
30-1230-L6	Adapter Cord, 6", Brown, P2, 2 Speed Amp to Molded	14/4	
30-1230-L48	Cord, Brown, P2, 2 Molded, Univ	14/4	
30-1230-L96	Cord, Brown, P2, 2 Molded, Univ	14/4	
09-0023C	Receptacle, Pump 2, 2 Speed, Molded/Colored	14/4	
30-0240-48-K	Cord, Pump, 1-Speed, Molded, 48"	14/3	 PINK
30-0240-96-K	Cord, Pump, 1-Speed, Molded, 96"	14/3	
30-1240-L6	Adapter Cord, 6", Pink, P2, 1 Speed Amp to Molded	14/3	
30-1240-L48	Cord, Pink, P2, 1 Molded, Univ	14/3	
30-1240-L96	Cord, Pink, P2, 1 Molded, Univ	14/3	
09-0024C-A	Receptacle, Pump 2, 1 Speed, Molded/Colored	14/3	
30-0250-48C-K	Cord, Gas, Molded/Colored, 48"	18/2	 WHITE
30-0250-96C	Cord, Gas, Molded/Colored, 96"	18/2	
09-0025C	Receptacle, Gas, Molded/Colored	18/2	
30-0260-48	Cord, Fiber Optic, Molded, 48"	18/4	 ORANGE
30-0260-96	Cord, Fiber Optic, Molded, 96"	18/4	
30-0260-L48	Cord, Fiber Optic, Molded, 48", Univ	18/4	
30-0260-L48UST	Cord, Fiber Optic, Molded, 48", UST01	18/4	
30-0260-L96	Cord, Fiber Optic, Molded, 96", Univ	18/4	
30-0260-L96A	Cord, Fiber Optic, Molded, 96", MxM	18/4	
09-0026C	Receptacle, Fiber Optic, Molded/Colored	18/4	
30-0270-48C-K	Cord, Hot ACC., Molded/Colored, 48"	18/3	 GREEN
30-0270-96C	Cord, Hot ACC., Molded/Colored, 96"	18/3	
30-1270-C6	Adapter Cord, 6", Green, ACC Amp to Molded	18/3	
09-0027C-A	Receptacle, Hot ACC., Molded/Colored	18/3	
30-0100A-30-K	Cord, Slide, Heater Power, Molded, 30"	12/3	 BLACK
30-0100A-60-K	Cord, VH, Heater Power, Molded, 60"	12/3	
09-0041A	Receptacle, VH, Molded/Colored	12/3	
30-0318-48	Cord, Univ, Amp Pins w/3&4 Pin Plugs, 48"	18/3	 UNIVERSAL
30-0318-96	Cord, Univ, Amp Pins w/3&4 Pin Plugs, 96"	18/3	
30-0324-72	Cord, Univ, Amp Pins w/3&4 Pin Plugs, 72"	14/3	
30-0324-96	Cord, Univ, Amp Pins w/3&4 Pin Plugs, 96"	14/3	
30-0326-72	Cord, Univ, Amp Pins w/4 Pin Plug, 72"	14/4	
30-0326-96	Cord, Univ, Amp Pins w/4 Pin Plug, 96"	14/4	
30-0016-K	Adapter, XM/XE to Amp, 120V		
30-0016A-K	Adapter, XM/XE to Amp, 240V		

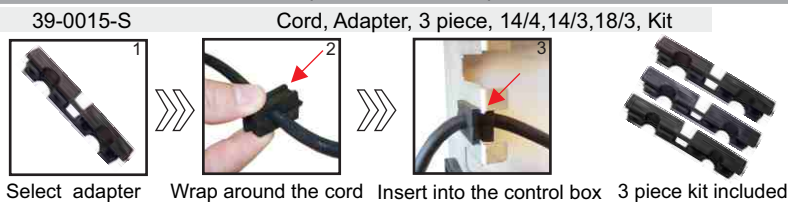

39-0035 Strain Relief, 12/3 Cable



39-0036 Strain Relief, 10/3 Cable



PART NUMBER	DESCRIPTION
37-0029-SM	Light Kit, 120V, W/Wall Fitting
37-0031-SM	Light Kit, 120V, L/Wall Fitting
25-0002-K	Light, Rear Access and Wall Fitting, no Bulb
37-0001-K	Light Lead, 2-Pin, 8'
25-21095-HQ-K	Light Assembly with Light Lead 8', Bulb & Reflector, Includes 25-0002-K
37-0014-K	Light Bulb, 12 Watt
37-0014-L-K	Light Bulb, LED 1.4W 10S Series



**Balboa heater to board connecting wires

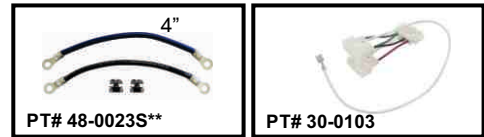

PART NUMBER	DESCRIPTION
30-0103	Balboa BP Splitter, Replaces PT# 30893
30-01395-K	Plug adapters for Double Barrel Htr, Temp & HL Sensor for use in IQ2000(1995-2002)
41-0010	Heater Current Collector
48-0021	Control Riser Kit, 1" Spacers and Screws helps elevate the control box.
48-0041-K	Turn-Around, Double Barrel Heater Manifold Kit
48-0041A-K	Gasket Kit for Double Barrel Heater
48-0041B-K	Barb, 3/4" Kit for Double Barrel Heater
48-0154	HC GFCI Removal Kit; 2 wire nuts, 2 hole plugs & wiring instructions
60-0008	Gasket, 1/2", Heater, Current Collector, Brett
60-0022-K	O-ring, Heater Bulkhead, 10 Pack - Also sold bundles of 100, 500, 1000 pcs.
48-0023	Heater Wire Kit, #10 x 4" Pair; replaces Balboa copper jumper straps, heater to board
48-0023A	Heater Wire Kit, #10 x 8" Pair; replaces Balboa copper jumper straps, heater to board
48-0023B	Heater Connection Kit, #10 x 4" x BP; connects BP board to heater terminals
48-0023C	Heater Connection Kit, #10 x 12" x BP; connects BP board to heater terminals
48-0023S	Heater Wire Kit, #10 x 4" Pair; with Hardware
48-0023XL	Heater Connection Kit, #10 x 16" Pair, Cal XL, connects heater terminals to board
15-0034	Base, 18"X26"X2", 8000 Outdoor Series (not shown)
15-0037A	Base, 14.5"X15", ES Air and Gecko Series (not shown)
15-0037B	Base, 14.5"X15", ES Balboa Series (not shown)

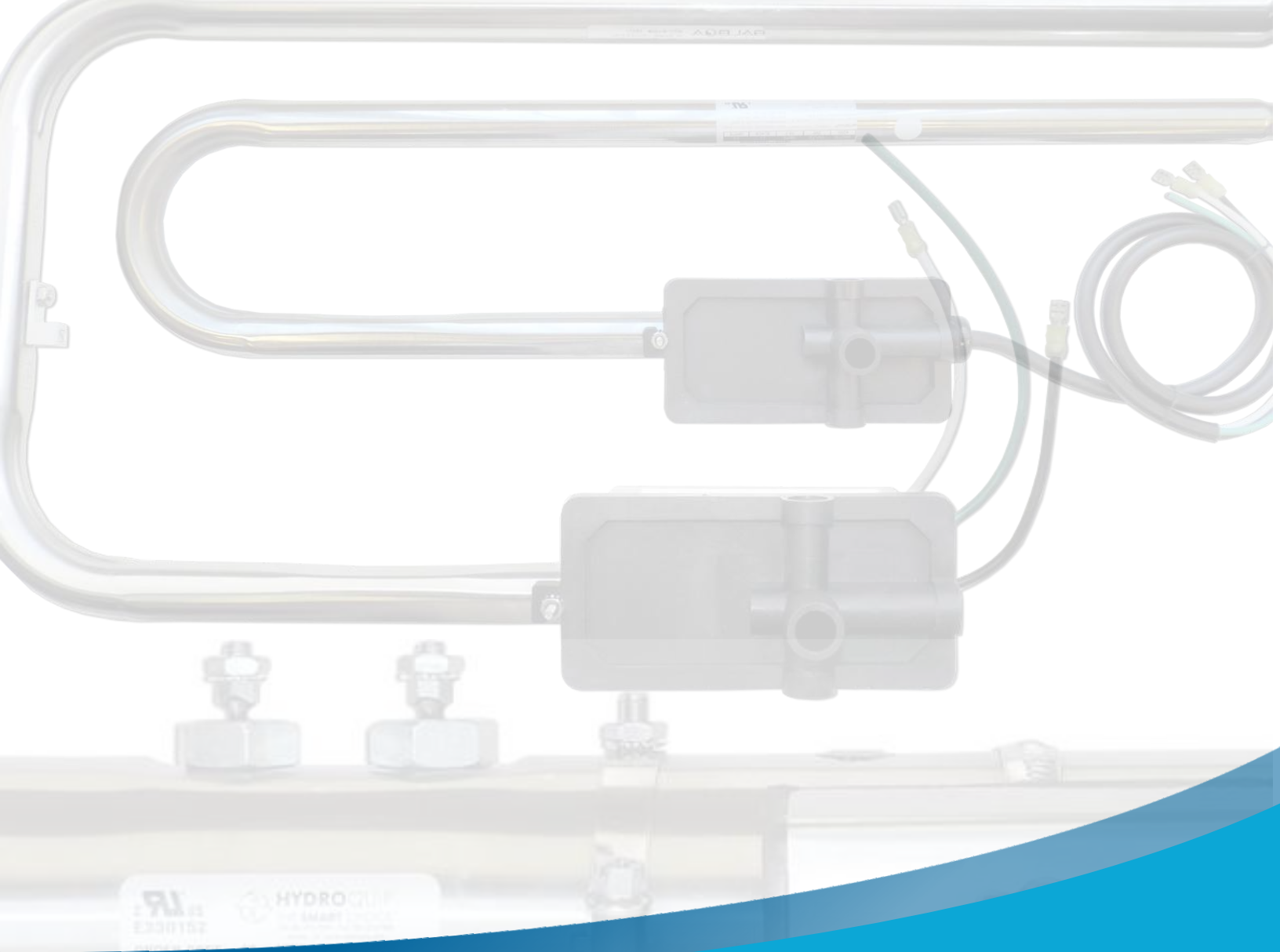

Heater Assemblies

HEATERS AND ELEMENTS

	PAGE
Universal Rite-Fit Heater Guide	82
Universal Rite-Fit Heater Series	83
Universal Lo-Flo Vertical Heater Series & Accessories	84-85
Double Barrel Lo-Flo Heater Replacement for Watkins	86
Water Pro Smart Heater Plus & Accessories	87
Lo-Flo Heater Replacements	88-89
Flo-Thru Heater Replacements	90-96
Balboa OEM Heater Replacements	97
Vertical Lo-Flo Heaters & Replacements	98-100
HQ Heater Replacements	101-106
Heater Element Replacements	107-108
HEATER ASSEMBLY CROSS REFERENCE GUIDE	109-128

If the Cross Reference Guide does not have the correct heater assembly your looking for, we offer our Universal Rite-Fit Heater assemblies in various configurations. By simply taking measurements of the heater your replacing and using our guidelines below, you can find the correct Universal Rite-Fit Heater to use as a replacement.

Heater Assembly Measurements

For proper measurements: Position the heater assembly with the flange closest to the bulk heads on the left side and measure from left flange to the first bulkhead as shown in Fig.1. The bulkhead measurement is key in determining the correct replacement. To indicate the proper position of items, always use the left side profile with the bulk heads in the 12:00 position as shown in Fig.2. Measurement results will determine which Universal Rite-Fit Heater would work for you

See part number description below. (Fig.3).

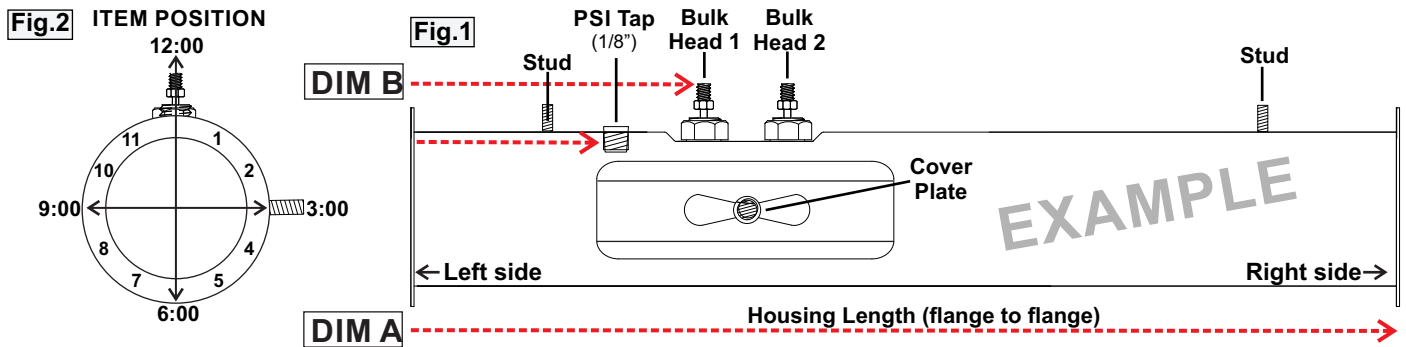

Note: Studs and Cover Plate are on adjustable bands that are provide with all Universal Rite-Fit Heaters.

Universal Rite-Fite Part Number Description

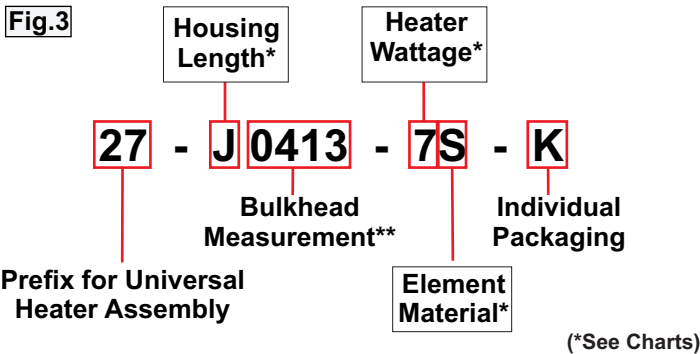

Description Charts

Housing Length	Heater Wattage		Element Material
F= 12 in. / 304.8 mm	0 = 1.0kW	4 = 3.0kW	S = Incoloy
G= 13 in. / 330.2 mm	1 = 1.5kW	A = 3.6kW	T = Titanium
J= 15 in. / 381.0 mm	2 = 2.0kW	5 = 4.0kW	
	3 = 2.5kW	6 = 4.5kW	
	B = 2.7kW	7 = 5.5kW	

**Bulkhead Measurement Example: 0413 = 4.13 in. / 25.4 mm

Universal Rite-Fite Heater Features

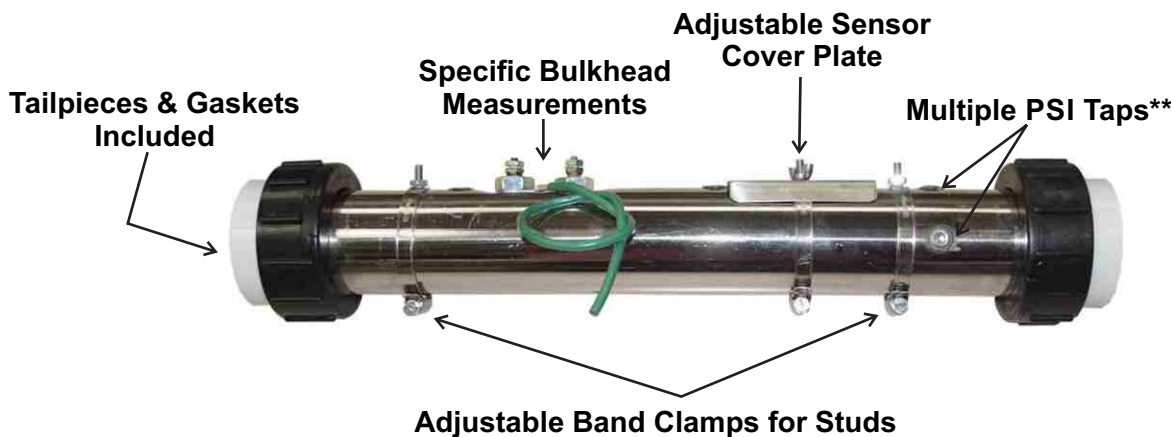



Titanium Element

27-J0425-7T-K	5.5kW/240V	27-J0425-4T-K	3.0kW/240V
27-J0425-6T-K	4.5kW/240V	27-J0425-3T-K	2.5kW/240V
27-J0425-5T-K	4.0kW/240V	27-J0425-2T-K	2.0kW/240V
27-J0425-AT-K	3.6kW/240V	27-J0425-XT-K	1.3kW/240V

Replaces:

(5.5kW) 48-1555-RP-BWG, 50071, 50076, 50080, 50096, 50134, 50150, 58000, 58002, 58010, 58016, 58019, 58026, 58027, 58066, 58074, 58083, 58086, 58089, 58105, 58121, 58123, 58209, C2550-0066ET, C2550-0535, C2550-0535-TPSC2550-0807, C2550-0807-TPS, C2550-0809, C2550-0809-1, C2550-0809-TPS

(4.0kW) 48-1540-RP-BWG, 50081, 50142, 53349, 55033, 55035, 58009, 58028, 58029, 58031, 58032, 58048, 58056, 58064, 58067, 58069, 58081, 58103, 58104, 58106, 58109, 58117, 58120, 58148, 58212, 58001, BAL50081, C2400-0073(S), C2400-0256(ET), C2400-0535, C2400-0535-TPS, C2400-0802ET, C2400-0807, C2400-0807-TPS, C2400-0809, C2400-0809-TPS, 48-3300-10-435H **(4.5kW)** 20-00324 **(3.0kW)** C2300-0807, C2300-0809, C2300-0535, C2300-1056, 50145, 58053, 58061, 58107, 58118, 58143CE **(2.5kW)** C2250-0066ET **(2.0kW)** 50139, 58063, 58145

Titanium Element

27-J0568-7T-K	5.5kW/240V	27-J0568-4T-K	3.0kW/240V
27-J0568-6T-K	4.5kW/240V	27-J0568-3T-K	2.5kW/240V
27-J0568-5T-K	4.0kW/240V	27-J0568-2T-K	2.0kW/240V
27-J0568-AT-K	3.6kW/240V	27-J0568-XT-K	1.3kW/240V

Replaces:

(5.5kW) 48-1555-RP-GEK, 20-00249, 20-00250, 20-00251, 20-00270, 20-00272, 20-00274, 530AA0107, 530AA0284, 530AA0437, 9920-100339, 9920-100347, B24055GM, B240055LA5, B24055LASD, B24055U, C2550-0601(ET), C2550-0601(G), C2550-0800(ET-G), C2550-0802ET

(4.0kW) 48-1540-RP-GEK, 20-00242, 20-00271, 20-00280, 20-00281, 20-00284, 20-00285, 20-00292, 20-00294, 20-00296, 20-0410, 530AA0078, 530AA0095, 530AA0293, 9920-100338, 9920-100346, B24040LA5, C2400-0601, C2400-0601ET, C2400-0800, C2400-0802ET, C2400-C2695-1, C2400-C3330-1A **(3.6kW)** C2360-0601, C2360-0601ET **(3.0kW)** C2300-0601, C2300-0601ET **(2.5kW)** C2250-0601, C2250-0601ET **(2.0kW)** 48-1520-RP-GEK, C2200-5003, C2200-0601ET, C2200-0601, C2200-0800ET, C2200-0800, B23020LA5

Titanium Element

27-J0519-7T-K	5.5kW/240V	27-J0519-4T-K	3.0kW/240V
27-J0519-6T-K	4.5kW/240V	27-J0519-3T-K	2.5kW/240V
27-J0519-5T-K	4.0kW/240V	27-J0519-2T-K	2.0kW/240V
27-J0519-AT-K	3.6kW/240V	27-J0519-XT-K	1.3kW/240V

Replaces:

(5.5kW) 48-1555-HQ, 26-0003A, 26-0032, 26-0032A, 26-0032-RIC, 26-0058, 26-0071, 26-0071-K, **(4.5kW)** 26-0047(-K), 26-0071A(-K), **(4.0kW)** 48-1540-HQ, 26-0036-R1C, 26-0071B, C2400-0267(ET) **(2.5kW)** 26-0309-3S-K

Titanium Element

27-J0413-7T-K	5.5kW/240V	27-J0413-4T-K	3.0kW/240V
27-J0413-6T-K	4.5kW/240V	27-J0413-3T-K	2.5kW/240V
27-J0413-5T-K	4.0kW/240V	27-J0413-2T-K	2.0kW/240V
27-J0413-AT-K	3.6kW/240V	27-J0413-XT-K	1.3kW/240V

Replaces:

(5.5kW) 48-1555-RP, 20-00228, 20-00425, 20-00232, 20-00328, 20-00503, 20-00319, 20-00417, 20-00530, C2550-0314ET, C2550-0456, C2550-0307ET, C2550-5000-1, HEA14100001

(4.5kW) 48-1545-RP, C2450-5000-1 **(4.0kW)** 48-1540-RP, 20-00317, 20-00318, 58004, C2400-0066ET-A, C2400-5000-1 **(2.0kW)** 48-1520-RP, C2200-5000-1, C2200-0456

Titanium Element

27-G0413-7T-K	5.5kW/240V		
27-G0413-6T-K	4.5kW/240V		
27-G0413-2T-K	2.0kW/240V		

Replaces:

(5.5kW) 20-08421-A, 26-0070-K, 26-1206-7S-K, C2550-1206, C2550-1206-1, C2550-1206-A, C2550-1206ET

(4.5kW) 26-0072A-K, C2450-0863 **(2.0kW)** 26-0070C-K, C2200-812ET, C2200-0812ET-G

Titanium Element

27-F0575-5T-K	4.0kW/240V		
27-F0575-2T-K	2.0kW/240V		

Replaces:

(4.0kW) 26-2300-5S-K, 46-238-1700, C2400-2300, C2400-2300ET

(2.0kW) 26-2300-2S-K, C2200-2300ET

Balboa® Universal Series - 15"

Universal Rite-Fit Balboa Series heater assembly, 2.25"x 15", 304SS, multiple PSI taps, M7 taps, adjustable cover plate, and adjustable studs. Includes 2"x2" tail pieces 2" ridged gaskets, 4" and 12" wire sets.



Gecko Universal Series - 15"

Universal Rite-Fit Gecko Series heater assembly, 2.25"x 15", 304SS, multiple PSI taps, adjustable cover plate, and adjustable studs. Includes 2"x2" tail pieces 2" ridged gaskets.



HQ Universal Series - 15"

Universal Rite-Fit Hydro-Quip Series heater assembly, 2.25"x 15", 304SS, multiple PSI taps, adjustable cover plate, and adjustable studs. Includes 2"x2" tail pieces 2" ridged gaskets.



Universal Rite-Fit Series - 15"

Universal Rite-Fit Series heater assembly, 2.25"x 15", 304SS, multiple PSI taps, adjustable cover plate, and adjustable studs. Includes 2"x2" tail pieces 2" ridged gaskets.



Universal Rite-Fit Series - 13"

Universal Rite-Fit Series heater assembly, 2.25"x 13", 304SS, multiple PSI taps, adjustable cover plate, and adjustable studs. Includes 2"x2" tail pieces 2" ridged gaskets.



Universal Rite-Fit Series - 12"

Universal Rite-Fit Series heater assembly, 2.25"x 12", 304SS, multiple PSI taps, adjustable cover plate, and adjustable studs. Includes 2"x2" tail pieces 2" ridged gaskets.



For a full list of heaters replaced by Universal Rite-Fits, see our Heater Cross Reference Guide

THE UNIVERSAL LOW FLOW VERTICAL RITE-FIT HEATER

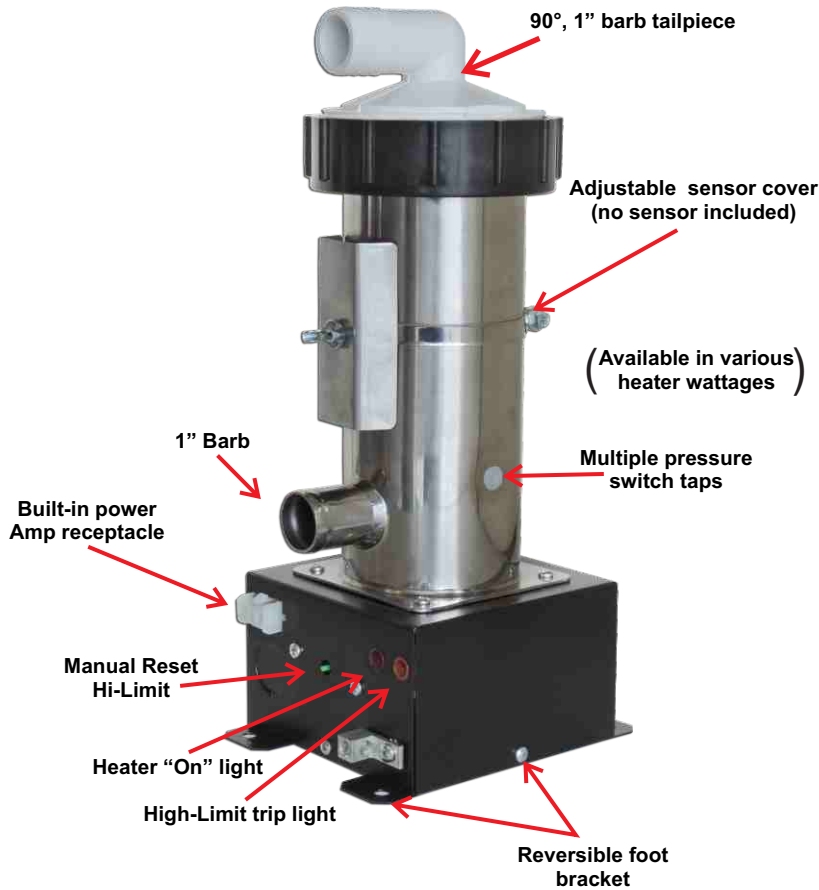

STANDARD FEATURES

- Titanium LWD Element
- Heater "ON" Indicator Light
- Hi-Limit Tripped Indicator Light
- Built-In Manual Reset Hi-Limit
- 3 Pressure Switch Taps
- Reversible Foot Bracket
- Adjustable Sensor Cover Kit
- 1" x 12" Tubing
- Barb adapter .75" x 1.0"
- Replaceable Heater Element
- 60", 3-pin Amp Cord w/Terminals
- Tailpiece 3" x 1", 90 degree barb
- Individually Packaged
- Installation Instructions

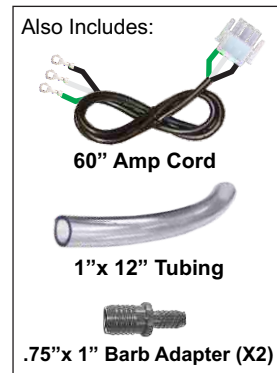

Universal Rite-Fit Low Flow Vertical Heaters

27-V310-2T-K	2.0kW, Titanium, Vertical Lo-Flo R/F Heater Assy
27-V310-4T-K	3.0kW, Titanium, Vertical Lo-Flo R/F Heater Assy
27-V310-5T-K	4.0kW, Titanium, Vertical Lo-Flo R/F Heater Assy
27-V310-6T-K	4.5kW, Titanium, Vertical Lo-Flo R/F Heater Assy
27-V310-7T-K	5.5kW, Titanium, Vertical Lo-Flo R/F Heater Assy

Rite-Fit Heater Accessories

Power Cord Options



30-0130-60-K
60" Cord, Large Molded

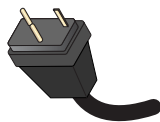

30-0131-60-K
60" Cord, Mini Molded

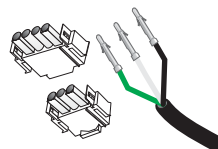

30-0133-60-K
60" Cord, 3 & 4Pin Amp



30-0132-60-K
60" Cord, 3 Ring Terminals
(Included w/Heater)

Pressure Switch Accessories

48-0300-K	Pressure Switch Kit, 3" Canister, 1A. Torx
48-0301-K	Pressure Switch Kit, 3" Canister, 2A. Slot
34-0178A-K	Pressure Switch, 1A. Plastic, Torx
34-0178-K	Pressure Switch, 2A. Plastic, Slot
34-0153-K	Pressure Switch, 25A. Metal, Wheel
34-0019-C-K	Pressure Switch, 25A. Plastic, Wheel
30-0015G-K	Cord, Wire x 2P Amp, Pressure Switch, 60"
30-0015J-K	Cord, Wire x Wire, Pressure Switch, 60"



Pressure Switch Kits

Flow Switch Options

34-0221-K	Flow Switch, .75" Barb x Barb Clear Tee
-----------	---



Flow Switch

Unions, Tailpieces & Gaskets

42-2360B-K	Uni-Nut, 3" Retaining Ring, White
42-2370-K	Uni-Nut, 3" Nut, Black
42-2380-K	Tailpiece, 3"x1", Vert. Barb
42-2386-K	Tailpiece, 3"x1", 90, Barb
42-2390-K	Tailpiece, 3"x.75", 90, Barb
42-2392-K	Tailpiece, 3"x1", 90, Soc
42-0013-K	Adaptor, Barb, .75"x1.0"
60-0020-K	Gasket, 3" Nut, Black



Clamps

39-0010-UR7-K	Clamp Kit, 3" 10-32 x 1", Sensor Cover
39-0010-B-K	Clamp Kit, 3" 10-32 x .75" Mounting
39-0010-UR9-K	Clamp Kit, 3" 10-32 x .625"
39-0010-UR8-K	Clamp Kit, 3" 10-32 x 1.875" Encl. Mtg.



Accessory Kits

48-0303-K	Sensor Kit, 3" Canister (No sensors included)
48-0304-K	Mounting Kit, 3" Canister
48-0305-K	Enclosure Kit, 3" Canister (No PS Included)
48-0310-K	Adapter, Pump, Tubing Step Down Kit, from 1" to 3/4"

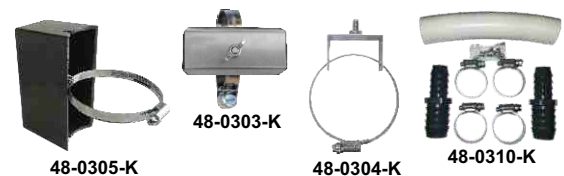

Heater Element Kits

12-0606F-K	Heater Element, 2.0kw, Ti
12-0604F-K	Heater Element, 3.0kw, Ti
12-0602F-K	Heater Element, 4.0kw, Ti
12-0601F-K	Heater Element, 4.5kw, Ti
12-0600F-K	Heater Element, 5.5kw, Ti

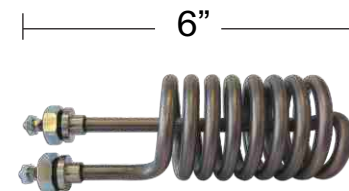

Spiral / Coil

DOUBLE BARREL LO-FLO HEATER REPLACEMENT FOR WATKINS



Double Barrel Heater Assembly, 316L, Auto-Reset High Limit, 55" Cord, Temp & HL Sensors, 3/4" Barb, Drain Tube Extension Kit & plug adapters for Temp & Hi-Limit Sensor for use in IQ2000(1995-2002)

Titanium Element

- 26-C3160-1S- 6.0kW/1.5kW Auto-Reset High Limit, 120/240V
- 26-C3160-2S- 4.0kW/1.0kW Auto-Reset High Limit, 120/240V
- 26-C3160-3S- 3.0kW Auto-Reset High Limit, 120/240V
- 26-C3182-1S- 1.5kW Auto-Reset High Limit, 240V Export

Replaces:

- (6.0kW)** C3160-1, 73790, C3564-1IHH-6000-NHCW-6759, IHH-6000-NHCW-7211.0
- (4.0kW)** C3160-2, 73039, 73791, C3564-2, IHH-4000-NHCW-6758
- (1.5kW)** C3182-1, 73792

Titanium Element w/Flow Switch

- 26-C3072-8T-KF - 6.0kW/1.5kW Auto-Reset High Limit, w/Flow Switch, 120/240V
- 26-C3072-5T-KF - 4.0kW/1.0kW Auto-Reset High Limit, w/Flow Switch, 120/240V
- 26-C3072-4T-KF - 3.0kW Auto-Reset High Limit, w/Flow Switch, 120/240V
- 26-C3073-1T-KF - 1.5kW Auto-Reset High Limit, w/Flow Switch, 240V Export

w/Flow Switch Replaces:

- (6.0kW)** C3072-1, C3072-1K1T, C3072-1K1TNB, C3072-1NS, C3072-1X
- (4.0kW)** C3072-2, C3072-2K1T, C3072-2K1TNB, C3072-2NS, C3072-2X
- (1.5kW)** C3073-1, C3073-1K1T, C3073-1K1TNB

Double Barrel Heater Accessories

30-01395-K	Plug adapters for DBL Htr, Temp & Hi-Limit Sensor for use in IQ2000(1995-2002)
34-01395-K	Replacement Sensor Kit for Watkins, Includes Temp Sensor, Hi-Limit & 2 O-Rings Replaces: RME-01395, 39525, 39530
34-39525-K	Replacement Sensor for Watkins, Individual Temp Sensor & O-Ring
34-39530-K	Replacement Sensor for Watkins, Individual Hi-Limit & O-Ring
48-0041-K	Turn-Around, Double Barrel Heater Manifold Kit
48-0041A-K	Gasket Kit for Double Barrel Heater
48-0041B-K	Barb 3/4" Kit for Double Barrel Heater



PT# 30-01395-K

PT# 34-01395-K

PT# 34-39525-K

PT# 34-39530-K

PT# 48-0041-K

PT# 48-0041A-K

PT# 48-0041B-K

Watkins Heater Elements

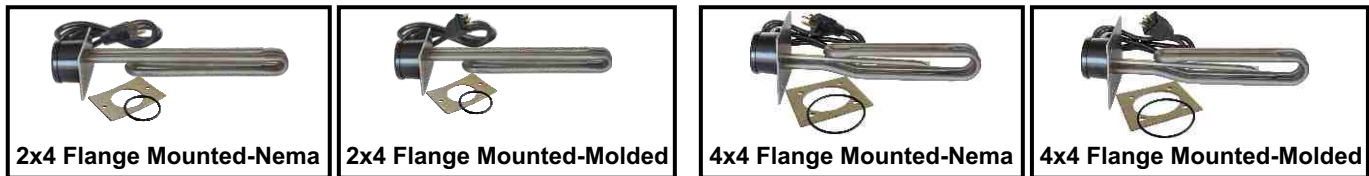

4" X 4" Flanged Mounted W/Cord

12-1464-BC-K	N/A	1.5KW, 120V, 4" x 4" Plate, w/ Molded 30" Cord
12-1464-AC-K	N/A	1.5KW, 120V, 4" x 4" Plate, w/ Nema 36" Cord

2" X 4" Flanged Mounted W/Cord

12-1463-BC-K	N/A	2.5KW, 240V, 2" x 4" Plate, w/ Molded 30" Cord
12-1463-AC-K	N/A	2.5KW, 240V, 2" x 4" Plate, w/ Nema 36" Cord

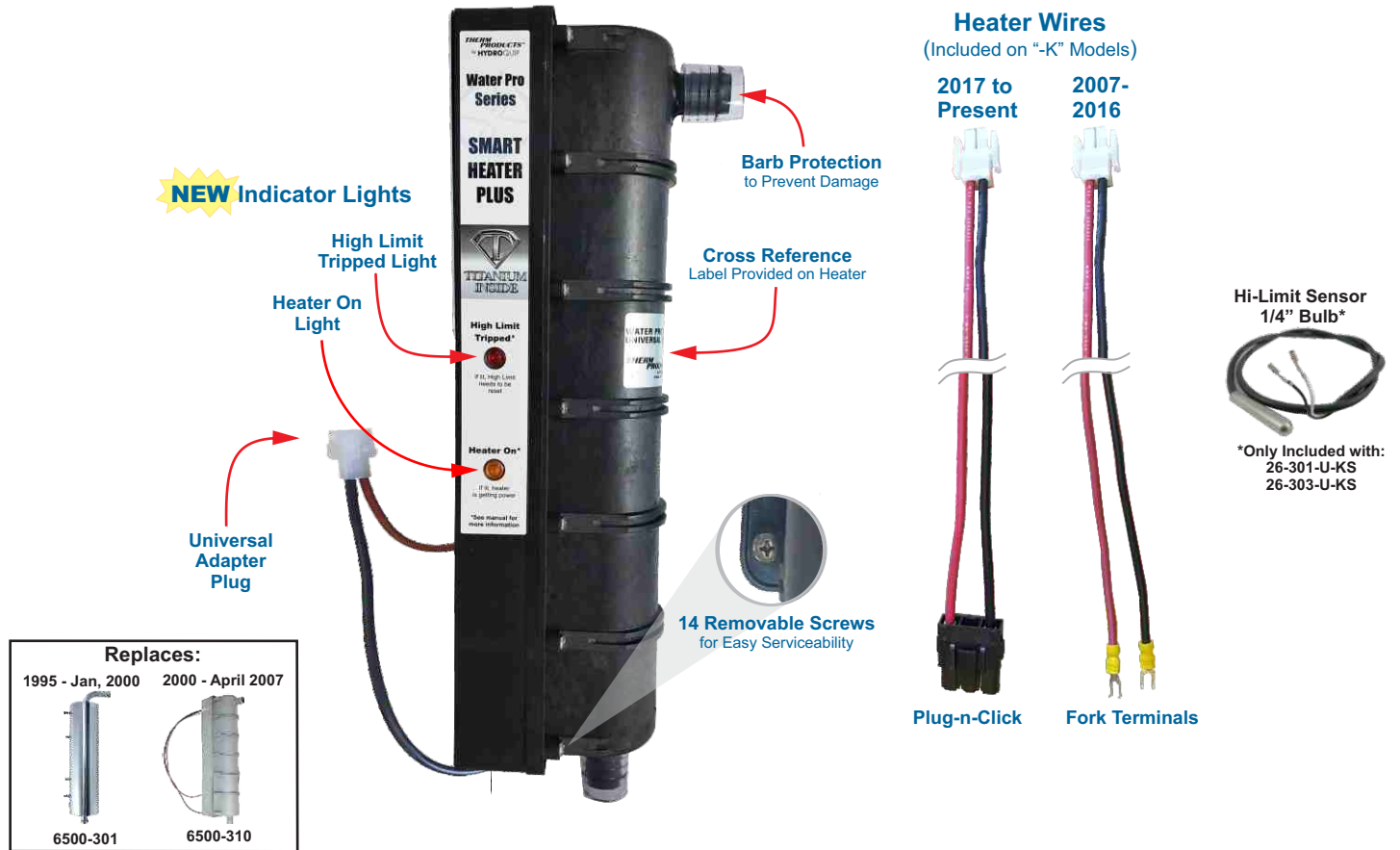

All Models from 2007 to 2020

Part Number	Description
26-310-U-K	Water Pro Series "Smart" Heater, Titanium 5.5kW, 240V Replaces: Sundance® 6500-310, 6500-316, 6500-843, Therm C3314-1, C3411-1, 58336, 26-3314-1-7T-K, 26-3411-1-7T-K, E2550-3314, 46-455-1010, 46-355-3025, 307878
26-315-U-K	Water Pro Series "Smart" Heater, Titanium 2.7kW, 240V Replaces: Sundance® 6500-315, 6500-844, 58335, Used on Sundance® 2001+ MAXXUS® Models, 26-3403-1-BT-K

All Models from 1995 to April 2007

26-301-U-KS	Water Pro Series "Smart" Heater Kit, Titanium 5.5kW, 240V Replaces: Sundance® 6500-301, SD6500-301, HTR6500301, 6500-301, 9143E, 2-00-0066, 323810810, 46-555-1000, 58030, E2550-1000
26-303-U-KS	Water Pro Series "Smart" Heater Kit, Titanium 2.7kW, 240V Replaces: Sundance® 6500-303, E2270-1000

Replacement Parts

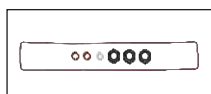

48-0045A
Gaskets and Bushings Kit
Replaces: 6560-049



48-0045B / 48-0045C
5.5kW Element/Gaskets/Bushings Kit
2.7kW Element/Gaskets/Bushings Kit



34-0202A-SUN-K
Hi Limit Circuit Sensor
Replaces: 6600-168, 6600-128



34-32016
Hi Limit, TCO, Auto Reset, 2016 to Present
Replaces: S093000, 2600-005



34-0010-K
Hi Limit, TCO, Auto Reset
Replaces: 6000-093



48-0054D
Heater Housing and Gasket Kit (Includes PT# 48-0045A)

Lo-Flo Heater Replacements

Aber-Pacific

Low Flow 20" x 16" x 14", 1" tube, Squareback style heater with 32" pigtail cord.

Replaces:

C3238-1A, SEH-5500-NHCW-6938

Titanium Element

26-3238-1H-7T-K - 5.5kW, 120/240V



Aber-Pacific / Artesian / Dynasty / Gecko

Low Flow 21" x 14.5", 1" tube, dual element squareback style, 4-wire tube heater that wraps around Gecko M class control box.

Replaces:

C3549-1, SHH-5500-NH-6727, C3242-1A

Titanium Element

26-C3549-1-7T-K - 5.5kW, 120/240V



Artesian / Atera/ HydroQuip / LA Spas

Low Flow 26" x 14", 1" tube, squareback style, 26" cord pigtail ends, pressure switch tap

Replaces:

(2.7kW) C3236-2A
(4.0kW) SEH-5500-NHW-6676, SEH-5500-NHW-7007, PEH-5526-NHW-6938, SEH-4100-NHCW-7130, SHH-5500-NH-6739, SEH-5500-NHW-6692, 7154, SEH-5500-NHW-6652, SEH-5500-NHCW-6632, C3236-1A

Titanium Element

26-3236-2H-BT-K - 2.7kW, 120/240V

26-3236-1H-BT-K - 2.7kW, 120/240V

26-3236-1A-5T-K - 4.0kW, 120/240V



Astrel

Low Flow 17.25" x 14.75 x 15.25", 1" tube, Dual Element, squareback style, 35" cord, pressure switch tap

Replaces:

(5.5kW) C3480-1

Titanium Element

26-C3480-1-7T-K - 5.5kW, 240V

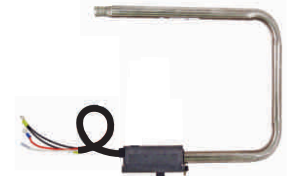

Cal Spas

Low Flow 1" tube with 26" Cord, minimum flow rate 10 GPM

Replaces:

(2.7kW) C3554-2
(4.0kW) C3554-3, F2550-4002

Titanium Element

26-C3554-2-BT-K - 41" - 2.7kW, 120/240V

26-C3554-3-5T-K - 41" - 4.0kW, 120/240V



Caldera/Watkins

Laing Trombone style, 26 1/2", 1" tube, 40" cord, pressure switch cord, built-in Thermal Cut Out (TCO), and Titanium element

Replaces:

(2.9kW) C3264-2, 26-3264-2-DT-K
(2.9kW, w/Flow Switch) C3472-2A
(4.0kW) C3473-1, 74912, 72494, 6595.1, 7340

Titanium Element

26-3473-1-5T-K - 4.0kW/240V

26-3472-2H-DT - 2.9kW/240V

With Flow Switch

26-3472-2H-DT-F - 2.9kW/240V, Export

26-3473-1H-5T-F - 4.0kW/240V, Export



Dimension One/Aber-Pacific

Laing 1" tube, 26" x 6" dual element Trombone style, 3' cord, with pump adapter kit.

Replaces:

C3556-1, PEH-4326-NHW-6000, PEH-5526-NHW-6388

Titanium Element

26-C3556-1-7T-K - 5.5kW, 120/240V



Dimension One/Jacuzzi

Laing, Squareback Style, 1" tube, built-in Manual Reset Thermal Cut Out (TCO), Mounting plate, 4 Wire and dual Titanium element.

Replaces:

C3242-1A, C3549-1, C3550-1, C3556-2, 9330-66, SHH-5500-NH-6871, SHH-5200-NH-6785, NHH-5500-NH-5500-NH-7328, SHH-5500-NH-6771, PEH-5526-NH-6742, PEH5526-NH-6340, PEH-5556-NHW-6388

Titanium Element

26-C3550-1-7T-K - 1" - 3.4/2.1kW 120/240V



Dimension One/Jacuzzi

Laing, Squareback Style, 1" tube, built-in Auto Reset Thermal Cut Out (TCO), Mounting plate, 4 Wire and dual Titanium element.

Replaces:

C3552-1, SHH-5500-NH-6871, SHH-5200-NH-6785, NHH-5500-NH-7328, SHH-5500-NH-6771

Titanium Element

26-C3552-1-7T-K - 1" - 3.4/2.1kW 120/240V

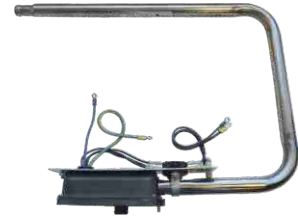

Dimension One/Jacuzzi

Laing, Triple Bend, 1" tube, built-in Thermal Cut Out (TCO), 4 Wire and dual Titanium element.

Replaces:

C3548-1, SEH-5500-NH, SEH-5200-NHC-7300, SEH-5200-NH-6757, SEH-5500-NH-6144, SEH-5500-NH-6143

Titanium Element

26-C3548-1-7T-K - 1" - 3.4/2.1kW 120/240V, Manual Reset TCO



Dimension One/Jacuzzi

Laing, Triple Bend, 1" tube, built-in Thermal Cut Out (TCO), Flow Switch, 4 Wire and dual Titanium element.

Replaces:

C3548-1, 01781-27, 73009, 61443, 6144.3, 6144, SEH-5500-NH, SEH550-NHC-7300, SEH5200-NH-6757, SEH-5500-NH-6144, SEH-5500-NH-61443,

Titanium Element

26-C3548-1-7T-F - 1" - 3.4/2.1kW 120/240V



Hawkeye

Laing, Complete Square, 1" tube, built-in Thermal Cut Out (TCO), Flow Switch, 4 Wire and Titanium element.

Replaces:

C6746-1, SEH-4100-NHW-6746

Titanium Element

26-6746-1H-5T-F - 1" - 4.0kW 120/240V



Sundance/Jacuzzi

Laing Trombone style, 1" tube, 25" cord, built-in Thermal Cut Out (TCO), and Titanium element

Replaces:

(4.0kW) 6500-063, C3226-1A, SEH-4300-NCHW-6699
(2.9kW) C3226-2, C3226-2A
(2.7kW) 6500-062
(2.1kW) C3226-4A

Titanium Element

26-3226-1A-5T-K - 1" - 4.0kW/240V
26-3226-2A-DT-K - 1" - 2.9kW/240V
26-3226-2A-BT-K - 1" - 2.7kW/240V, Export
26-3226-4A-ET-K - 1" - 2.1kW/240V

Dimensions:

A: 5 5/8"
B: 15 3/4"
C: 26 1/2"

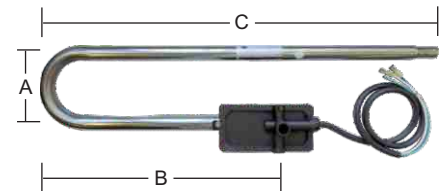

Sundance/Jacuzzi

Laing Squareback style, 1" tube, 3 wire with spade connectors, built-in Thermal Cut Out (TCO), Titanium element

Replaces:

(2.7kW) 6500-401
(5.5kW) 6500-402, C3229-2A, 6500-403, C3229-1A, SEH-5500-NH-6698, SEH-5500-NHC-6699

Titanium Element

26-3478-1A-BT-K - 1" - 2.7kW/240V, Export
26-3229-1H-BT-K - 1" - 2.7kW/240V
26-58388-5T-ATE - 1" - 4.0kW/240V
26-3229-2A-7T-K - 1" - 5.5kW/240V
26-3229-2H-7T-K - 1" - 5.5kW/240V

Dimensions:

A: 10 7/8"
B: 13 3/4"
C: 23 1/2"

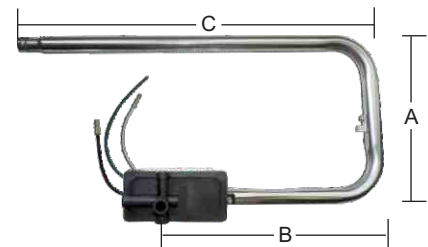

Flo-Thru Heater Replacements



HYDROQUIP™
THE SMART CHOICE™

ACC, Acura, Brett

Flo-Thru heater assembly, 2.25"x 15", 304SS, PSI tap, with cover plate and studs. Includes 2"x2" tail pieces, 2" ridged gaskets.

Replaces:

(4.0kW) C2400-0304(ET), C2400-0314, 20-00433, 20-00434, 20-00454, 20-00317
(5.5kW) C2550-0304TI, 20-00430, 20-00417, 20-00307, B24055B, B24055E, C2550-0314(ET), 48-3300-10-154H



Incoloy Element

26-0314-5S-K - 4.0kW/240V
26-0314-7S-K - 5.5kW/240V

Titanium Element

26-0314-5T-K - 4.0kW/240V
26-0314-7T-K - 5.5kW/240V

Universal Rite-Fit Replacement

27-J0438-5S-K - 4.0kW/240V
27-J0438-7S-K - 5.5kW/240V

ACC

Flo-Thru heater assembly, 2.25"x 12", 304SS, PSI tap, with cover plate and studs. Includes 2"x2" tail pieces, 2" ridged gaskets.

Replaces:

C2550-1004TI, C2550-1004TI-1



Incoloy Element

26-1004-7S-K - 5.5kW/240V

Titanium Element

26-1004-7T-K - 5.5kW/240V

Universal Rite-Fit Replacement

27-F0288-7S-K - 5.5kW/240V

ACC

Flo-Thru heater assembly, 2.25"x 15", 304SS, PSI tap, with cover plate and studs. Includes 2"x2" tail pieces, 2" ridged gaskets.

Replaces:

C2550-1054, C2550-1054TI, C2550-1054TI-1



Incoloy Element

26-1054-7S-K - 5.5kW/240V

Titanium Element

26-1054-7T-K - 5.5kW/240V

Arctic Spas

Flo-Thru heater assembly, 2.25"x 12", 316L, PSI tap, with cover plate and power cords. Includes 2"x2" tail pieces, 2" ridged gaskets.

Replaces:

(3.6kW) 48-9151, 48-9151-R1 thru 2
(4.0kW) 48-9150, 48-9150-K, 48-9150-R1 thru 6, 48-9150-S, 48-9150-R2-S
(5.5kW) 48-9120, 48-9120-K, 48-9120-R1 thru 6, C2550-0103TT



Titanium Element

48-9151-AP-K - 3.6kW/240V
48-9150-5P-K - 4.0kW/240V
48-9120-7P-K - 5.5kW/240V

Arctic Spas

"L" Shape heater assembly, 2.25"x 12.7", 304SS, PSI tap, with cover plate and power cord. Includes 2"x2" tail pieces, 2" ridged gaskets.

Replaces:

(3.6kW) 48-9122, 48-9122-R1 thru 4, A2360-5350ET
(5.5kW) 48-9121, 48-9121-R1 thru 4, A2550-5350ET, A2550-5300(ET)



Incoloy Element

48-9121-7S-K - 5.5kW/240V

Titanium Element

48-9122-AT-K - 3.6kW/240V

Arctic Spas

"L" Shape heater assembly, 2.25"x 9", PSI tap, with cover plate and power cords. Includes 45 degree elbow, 2"x2" tail pieces, 2" ridged gaskets.

Replaces:

(3.6kW) 48-9124, 48-9124-K, 48-9124-R1 thru 4, A2360-5251ET, A2360-5250ET, A2360-5200ET, A2360-5100ET
(5.5kW) 48-9123, 48-9123-R2 thru 4, A2550-5251ET, A2550-5100ET, A2550-5200ET, A2550-5251ETX, A2550-5250ET, 22-00254, 22-00255, 22-00256



Titanium Element

48-9124-AP-K - 3.6kW/240V, 316L
48-9123-7T-K - 5.5kW/240V, 304SS

Arctic Spas

Flo-Thru heater assembly, 2.25"x 15", 304SS, PSI tap, with cover plate and power cord. Includes 2"x2" tail pieces, 2" ridged gaskets.

Replaces:

(4.0kW) 48-9125, 48-9125-R1



Titanium Element

48-9125-5T-K - 4.0kW/240V

Arctic Spas

Flo-Thru heater assembly, 2.25"x 19.25", 316L, Dual element, PSI tap, with cover plate and power cord. Includes 2"x2" tail pieces, 2" ridged gaskets.

Replaces:

(7.2kW) 48-9130, 48-9130-K, 48-9130-R1 thru 4



Titanium Element

48-9130-CP-K - 7.2kW/240V

Apollo Spas

Flo-Thru heater assembly, 2.25"x 15", 316L, PSI tap, with cover plate and power cords. Includes 2"x2" tail pieces, 2" ridged gaskets.

Replaces:

C2450-0136-C



Incoloy Element

26-H0136-6S-K - 4.5kW/240V

All heater assemblies come with tail pieces and gaskets

Flo-Thru Heater Replacements



HYDROQUIP™
THE SMART CHOICE™

Balboa®

Flo-Thru heater assembly, 2.25"x 15", 304SS, with M7" sensors, and studs. Includes 2"x2" tail pieces, 2" ridged gaskets.

Incoloy Element

26-58104-K - 4.0kW/240V
26-58083-K - 5.5kW/240V

Replaces:

(4.0kW) 55625, 55033, 55035, 58031, 58056, 58064, 58104, 58106, 58109, 58117, 58120, 58148, 58212, C2400-0807-TPS
(5.5kW) 55624, 58000, 58010, 58083, 58086, 58089, 58105, 58121, 58123, 58209, C2550-0807-TPS



Balboa®

Flo-Thru heater assembly, 2.25"x 15", 304SS, two PSI taps, with cover plate. Includes 2"x2" tail pieces, 2" ridged gaskets.

Incoloy Element

26-0035-7S-K - 5.5kW/240V

Replaces:

C2550-0035, 48-3300-10-035H



Titanium Element

26-0035-7T-K - 5.5kW/240V

Universal Rite-Fit Replacement

27-J0413-7S-K - 5.5kW/240V

Balboa®

Flo-Thru heater assembly, 2.25"x 15", 304SS, PSI tap, with cover plate. Includes 2"x2" tail pieces, 2" ridged gaskets.

Incoloy Element

26-0535-4S-K - 3.0kW/240V
26-0535-5S-K - 4.0kW/240V
26-0535-7S-K - 5.5kW/240V

Replaces:

(3.0kW) C2300-0535ET
(4.0kW) 48-3300-10-435H, 50081, BAL50081, C2400-0535
(5.5kW) 50080, C2550-0435, C2550-0535, C2550-0537, C2550-0735, C2550-07352



Titanium Element

26-0535-5T-K - 4.0kW/240V
26-0535-7T-K - 5.5kW/240V

Universal Rite-Fit Replacement

27-J0413-4S-K - 3.0kW/240V
27-J0413-5S-K - 4.0kW/240V
27-J0413-7S-K - 5.5kW/240V

Balboa®

Flo-Thru heater assembly, 2.25"x 15", 304SS, with PSI & guard, with cover plate. Includes 2"x2" tail pieces, 2" ridged gaskets.

Incoloy Element

Ⓐ **26-0535-5S-KP** - 4.0kW/240V
Ⓐ **26-0535-7S-KP** - 5.5kW/240V
Ⓑ **26-0535-5S-KP01** - 4.0kW/240V
Ⓑ **26-0535-7S-KP01** - 5.5kW/240V

Replaces:

(4.0kW) 50067, 50142, 58009, 58069, 58081, C2400-0535-TPS
(5.5kW) 50071, 50076, 50096, 50134, 50150, C2550-0535-TPS



Titanium Element

Ⓐ **26-0535-5T-KP** - 4.0kW/240V
Ⓐ **26-0535-7T-KP** - 5.5kW/240V

Ⓐ = With PSI PT# 34-0153 w/guard
Ⓑ = With PSI PT# 34-0019-C no guard



Universal Rite-Fit Replacement

27-J0413-5S-K - 4.0kW/240V
27-J0413-7S-K - 5.5kW/240V
(No pressure switch included)

Balboa®

Flo-Thru heater assembly, 2.25"x 15", 304SS, PSI tap, and sensor tap. Includes 2"x2" tail pieces, 2" ridged gaskets.

Incoloy Element

26-0809-5S-K - 4.0kW/240V
26-0809-7S-K - 5.5kW/240V

Replaces:

(4.0kW) 58029, C2400-0809
(5.5kW) 58027, C2550-0809-1



Titanium Element

26-0809-5T-K - 4.0kW/240V
26-0809-7T-K - 5.5kW/240V

Universal Rite-Fit Replacement

27-J0413-5S-K - 4.0kW/240V
27-J0413-7S-K - 5.5kW/240V

Balboa®

Flo-Thru heater assembly, 2.25"x 15", 304SS, with PSI switch w/guard, and sensor tap. Includes 2"x2" tail pieces, 2" ridged gaskets.

Incoloy Element

26-0809-5S-KSP - 4.0kW/240V
26-0809-7S-KSP - 5.5kW/240V

Replaces:

(4.0kW) 53349, 58028, 58048, 58067, C2400-0809-TPS
(5.5kW) 58019, 58026, 58066, 58074, C2550-0809-TPS



Titanium Element

26-0809-5T-KSP - 4.0kW/240V
26-0809-7T-KSP - 5.5kW/240V

Universal Rite-Fit Replacement

27-J0413-5S-K - 4.0kW/240V
27-J0413-7S-K - 5.5kW/240V
(No pressure switch included)

Cal Spas

Flo-Thru heater assembly, 2.25"x 16.25", 304SS, PSI tap, cover plate. Includes 2"x2" tail pieces, 2" ridged gaskets.

Incoloy Element

26-0165-3S-K - 2.5kW/240V
26-0165-5S-K - 4.0kW/240V
26-0165-7S-K - 5.5kW/240V

Replaces:

(2.5kW) C2250-0165, HEA14100010
(4.0kW) C2400-0165
(5.5kW) C2550-0165



Titanium Element

26-0165-3T-K - 2.5kW/240V
26-0165-5T-K - 4.0kW/240V
26-0165-7T-K - 5.5kW/240V

Universal Rite-Fit Replacement

27-K0550-3S-K - 2.5kW/240V
27-K0550-5S-K - 4.0kW/240V
27-K0550-7S-K - 5.5kW/240V

All heater assemblies come with tail pieces and gaskets

Call (951) 273-7575

Flo-Thru Heater Replacements



HYDROQUIP™
THE SMART CHOICE™

Cal Spas

Flo-Thru heater assembly, 2.25"x 15", 316SS, PSI tap, cover plate, includes 1.5"x2" tail pieces with o-rings, 2" ridged gaskets.

Incoloy Element

26-H0021-7S-K - 5.5kW/240V

Replaces:

C2550-0021, C2550-0021ET, C2550-0022, C2550-0022ET, C2550-0023



Universal Rite-Fit Replacement

27-J0425-7S-K - 5.5kW/240V

Cal Spas XL

Flo-Thru heater assembly, 2.25"x 15", 304SS, PSI tap, cover plate, with stud, insulated aluminum housing, heater wires w/connectors. Includes 2"x2" tail pieces, 2" ridged gaskets.

Incoloy Element

26-0011-3S-K - 2.5kW/240V

26-0011-5S-K - 4.0kW/240V

26-0011-7S-K - 5.5kW/240V

Replaces Incoloy:

(2.5kW) C2250-0011, F2250-0001, F2250-0011

(4.0kW) C2400-0011, F2400-0011, B24040XL

(5.5kW) B24055XL, C2550-0011, F2550-0001, F2550-0011, HEA14100120, HEA14100121, HEA14100401, XL5.5

Replaces Titanium:

(4.0kW) C2400-0011TI, HEA14100131

(5.5kW) C2550-0011TI, HEA14100300, HEA14100470



Titanium Element

26-0011-F-PS-K - 4.0kW/240V

26-0011-F-RS-K - 5.5kW/240V

Cal Spas

Flo-Thru heater assembly, 2.25"x 15", 304SS, heater wires w/connectors. Includes 2"x2" tail pieces, 2" ridged gaskets, w/Insulation wrap.

Incoloy Element

26-2001-3S-K - 2.5kW/240V

26-2001-5S-K - 4.0kW/240V

26-2001-7S-K - 5.5kW/240V

Replaces:

(2.5kW) C2250-2001-1

(4.0kW) C2400-2001

(5.5kW) C2550-2001, HEA14100430



Titanium Element

26-2001-3T-K - 2.5kW/240V

26-2001-5T-K - 4.0kW/240V

26-2001-7T-K - 5.5kW/240V

Caldera

Flo-Thru heater assembly, 2.25"x 15", 304SS, PSI tap, ground strip, with mounting studs. Includes 2"x2" tail pieces, 2" ridged gaskets, and (2) heater wires.

Incoloy Element

26-3330-5S-K - 4.0kW/240V

Replaces:

C2400-C3330-1A, 73994,

C2400-C2695-1, 58286



Titanium Element

26-3330-5T-K - 4.0kW/240V

Universal Rite-Fit Replacement

27J0568-5S-K - 4.0kW/240V

Coates

Flo-Thru heater assembly, 2.25"x 15", 316L SS, PSI tap, cover plate, with studs. Includes 2"x2" tail pieces, 2" ridged gaskets

Titanium Element

26-0517-4P-K - 3.0kW/240V

26-0517-5P-K - 4.0kW/240V

26-0517-MP-K - 5.5kW/240V

Replaces:

(3.0kW) C2300-0517

(4.0kW) C2400-0517

(5.5kW) C2550-0517, 20-00517



Correct Tech

Flo-Thru heater assembly, 2.25"x 12.63", 304SS, PSI tap, with cover plate, and studs. Includes 2"x2" tail pieces, 2" ridged gaskets.

Incoloy Element

26-2300-2S-K - 2.0kW/240V

26-2300-4S-K - 3.0kW/240V

26-2300-5S-K - 4.0kW/240V

Replaces:

(2.0kW) C2200-2300ET

(3.0kW) C2300-2300ET

(4.0kW) C2400-2300ET, 46-238-1700



Titanium Element

26-2300-2T-K - 2.0kW/240V

26-2300-4T-K - 3.0kW/240V

26-2300-5T-K - 4.0kW/240V

DM/Vita

Flo-Thru heater assembly, 2.25"x 15", 304SS, PSI tap, cover plate, with studs. Includes 2"x2" tail pieces, 2" ridged gaskets, and heater wires.

Incoloy Element

26-0010-4S-K - 3.0kW/240V

26-0010-6S-K - 4.5kW/240V

Replaces:

(3.0kW) C2300-0010ET

(4.5kW) C2450-0010ET



Titanium Element

26-0010-4T-K - 3.0kW/240V

26-0010-6T-K - 4.5kW/240V

Universal Rite-Fit Replacement

27-J0413-4S-K - 3.0kW/240V

27-J0413-6S-K - 4.5kW/240V

DM/Vita

Flo-Thru heater assembly, 2.25"x 15", 304SS, No PSI tap, cover plate, with studs. Includes 2"x2" tail pieces, 2" ridged gaskets, and heater wires.

Incoloy Element

26-0024-4S-K - 3.0kW/240V

Replaces:

C2300-0024ET



Titanium Element

26-0024-4T-K - 3.0kW/240V

Universal Rite-Fit Replacement

27-J0413-4S-K - 5.5kW/240V

All heater assemblies come with tail pieces and gaskets

Flo-Thru Heater Replacements



HYDROQUIP™
THE SMART CHOICE™

DM/Vita

Flo-Thru heater assembly, 2.25"x 15", 304SS, No PSI tap, with studs. Includes 2"x2" tail pieces, 2" ridged gaskets, and heater wires.

Incoloy Element

26-0028-4S-K - 3.0kW/240V
26-0028-5S-K - 4.0kW/240V

Replaces:

(3.0kW) C2300-0028ET
(4.0kW) C2400-0028ET, C2400-0027ET



Universal Rite-Fit Replacement

27-J0413-4S-K - 3.0kW/240V
27-J0413-5S-K - 4.0kW/240V

DM/Vita

Flo-Thru heater assembly, 2.25"x 17.75", 304SS, No PSI tap, cover plate, with studs. Includes 2"x2" tail pieces, 2" ridged gaskets, and heater wires.

Titanium Element

26-1008-4T-K - 3.0kW/240V
26-1008-6T-K - 4.5kW/240V
26-1008-7T-K - 5.5kW/240V

Replaces:

(3.0kW) C2300-1008ET
(4.5kW) C2450-1008ET, 411092, VIT411092
(5.5kW) 20-00467, 9142C, C2550-1008ET



Incoloy Element

26-1008-4S-K - 3.0kW/240V
26-1008-6S-K - 4.5kW/240V
26-1008-7S-K - 5.5kW/240V

Dimension One

Flo-Thru heater assembly, 2.25"x 12", 316L, with PSI tap, cover plate, and studs. Includes 2"x2" tail pieces, 2" ridged gaskets.

Incoloy Element

26-0001-5S-K - 4.0kW/240V

Replaces:

(4.0kW) C2400-0001



Gecko Heat.Wav

Flo-Thru heater assembly, 2.25"x 15", 304SS, PSI tap, with mounting studs. Includes 2"x2" tail pieces, 2" ridged gaskets. This heater assembly is the appropriate replacement for any spas that use Gecko IN.XE or IN.YE control packs.

Replaces:

(4.0kW) 9920-101435, 9735-334,
9917-101272, T9920-101435



Incoloy Element

26-101435-5S-K - 4.0kW/240V

Gecko M Class

Flo-Thru heater assembly, 2.25"x 15", 304SS, PSI tap, with mounting studs. Includes 2"x2" tail pieces, 2" ridged gaskets.

Incoloy Element

26-0601-2S-K - 2.0kW/240V
26-0601-3S-K - 2.5kW/240V
26-0601-5S-K - 4.0kW/240V
26-0601-7S-K - 5.5kW/240V

Titanium Element

26-0601-2T-K - 2.0kW/240V
26-0601-3T-K - 2.5kW/240V
26-0601-PT-K - 3.6kW/240V
26-0601-5T-K - 4.0kW/240V
26-0601-7T-K - 5.5kW/240V



Universal Rite-Fit Replacement

27-J0568-AS-K - 3.6kW/240V
27-J0568-5S-K - 4.0kW/240V
27-J0568-7S-K - 5.5kW/240V

Replaces:

(2.0kW) C2200-06019ET (2.5kW) C2250-0601(ET) (3.6kW) C2360-C601TI, C2360-0601ET (4.0kW) 20-00271, 20-00280, 20-00281, 20-00292, 20-00294, 20-00296, 20-00410, 530AA0293, 9920-100346, B24040LA5, C2400-0601, C2400-0601ET, C2400-C2695-1, C2400-C3330-1A (5.5kW) 20-00249, 20-00250, 20-00251, 20-00270, 530AA0284, 530AA0437, 9920-100347, B24055LA5, B24055LASD, B24055U, C2550-0601(ET), C2550-0601

Gecko S Class/Caldera/Nordic

Flo-Thru heater assembly, 2.25"x 15", 304SS, PSI tap, with studs. Includes 2"x2" tail pieces, 2" ridged gaskets.

Incoloy Element

26-0800-2S-K - 2.0kW/240V
26-0800-3S-K - 2.5kW/240V
26-0800-4S-K - 3.0kW/240V
N/A
26-0800-5S-K - 4.0kW/240V
26-0800-7S-K - 5.5kW/240V

Titanium Element

26-0800-2T-K - 2.0kW/240V
26-0800-3T-K - 2.5kW/240V
26-0800-4T-K - 3.0kW/240V
26-0800-AT-K - 3.6kW/240V
26-0800-5T-K - 4.0kW/240V
26-0800-7T-K - 5.5kW/240V

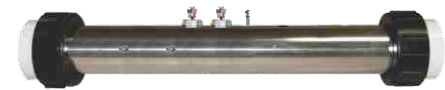

Universal Rite-Fit Replacement

27-J0568-2S-K - 2.0kW/240V
27-J0568-3S-K - 2.5kW/240V
27-J0568-4S-K - 3.0kW/240V
27-J0568-AS-K - 3.6kW/240V
27-J0568-5S-K - 4.0kW/240V
27-J0568-7S-K - 5.5kW/240V

Replaces:

(2.0kW) C2200-0800(ET), C2200-0800ET-G, C2400-C3464-1, 72651, C2400-C2695-1 (2.5kW) C2250-0800 (3.0kW) C2300-0800 (3.6kW) C2360-0800 (4.0kW) 20-00242, 20-00284, 20-00285, 530AA0078, 530AA0095, 9920-100338, C2400-0800 (5.5kW) 20-00272, 20-00274, 530AA0107, 9920-100339, B24055GM, C2550-0800(ET-G)

Gecko/Morgan

Flo-Thru heater assembly, 2.25"x 15", 304SS, PSI tap, cover plate, with studs. Includes 2"x2" tail pieces, 2" ridged gaskets.

Replaces:

(4.0kW) C2400-0802ET
(4.5kW) C2450-0802ET
(5.5kW) C2550-0802ET

Incoloy Element

(A) 26-0802-5S-K - 4.0kW/240V
(A) 26-0802-6S-K - 4.5kW/240V
(A) 26-0802-7S-K - 5.5kW/240V
(B) 26-0802A-3S-K - 2.5kW/240V
(B) 26-0802A-5S-K - 4.0kW/240V
(B) 26-0802A-6S-K - 4.5kW/240V

Titanium Element

(A) 26-0802-5T-K - 4.0kW/240V
(A) 26-0802-6T-K - 4.5kW/240V
(A) 26-0802-7T-K - 5.5kW/240V

(A) = With Two Upper Studs
(B) = Without Two Upper Studs

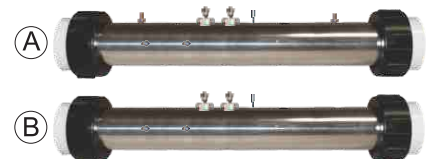

Universal Rite-Fit Replacement

27-J0568-3S-K - 2.5kW/240V
27-J0568-5S-K - 4.0kW/240V
27-J0568-6S-K - 4.5kW/240V
27-J0568-7S-K - 5.5kW/240V

All heater assemblies come with tail pieces and gaskets

Gecko

Flo-Thru heater assembly, 3"x 15", 304SS, PSI tap, and studs. Includes 3"x2" tail pieces, 3" ridged gaskets.

Incoloy Element

26-3602-7S-K - 5.5kW/240V

Replaces:

C2550-3602ET-G, C2550-3600ET-G



Hercules

Flo-Thru heater assembly, 2.25"x 15", 304SS, PSI tap, with cover plate, and studs. Includes 2"x2" tail pieces, 2" ridged gaskets.

Incoloy Element

26-0315-5S-K - 4.0kW/240V

Replaces:

12077, C2400-0315, pre-95 XT



Titanium Element

26-0315-5T-K - 4.0kW/240V

Hercules

Flo-Thru heater assembly, 2.25"x 18", 304SS, PSI tap, with cover plate, and studs. Includes 2"x2" tail pieces, 2" ridged gaskets.

Incoloy Element

26-0155-7S-K - 5.5kW/240V

Replaces:

C2550-0157, C2550-0154, 48-3300-10-154H, 48-3300-10-155H



HydroQuip / Therm Products

Flo-Thru heater assembly, 2.25x 15", 304SS, no PSI tap, with cover plate. Includes 2"x2" tail pieces, 2" ridged gaskets.

Incoloy Element

26-0309-3S-K - 2.5kW/240V

26-0309-4S-K - 3.0kW/240V

Replaces:

*(2.5kW) C2250-0309ET, 20-00287C, B23025R1
(3.0kW) C2300-0309*



Universal Rite-Fit Replacement

27-J0519-3S-K - 2.5kW/240V

27-J0519-4S-K - 3.0kW/240V

Hurricane Spas

Flo-Thru heater assembly, 2.25"x 15", 304SS, with PSI tap, thermo wells, and studs. Includes 2"x2" tail pieces, 2" ridged gaskets.

Incoloy Element

26-0002-3S-K - 2.5kW/240V

26-0002-4S-K - 3.0kW/240V

26-0002-7S-K - 5.5kW/240V

Replaces:

*(2.5kW) C2250-0002 (3.0kW) C2300-0002
(5.5kW) C2550-0002/ET, 20-00224, 20-00424, 48-3300-16*



Universal Rite-Fit Replacement

27-J0425-3S-K - 2.5kW/240V

27-J0425-4S-K - 3.0kW/240V

27-J0425-7S-K - 5.5kW/240V

L.A. Spas / Advanced Spas

Flo-Thru heater assembly, 2.25"x 15", 304SS, PSI tap, with cover plate, and studs. Includes 2"x2" tail pieces, 2" ridged gaskets.

Incoloy Element

26-0736-3S-K - 2.5kW/240V

26-0736-7S-K - 5.5kW/240V

Replaces:

*(2.5kW) C2250-0736
(5.5kW) C2550-0736(ET), B24055LA2, 48-3300-10-736H*



Universal Rite-Fit Replacement

27-J0425-3S-K - 2.5kW/240V

27-J0425-7S-K - 5.5kW/240V

Leisure Bay Spas

Flo-Thru heater assembly, 3" x 17.50", 304SS, PSI tap, with cover plate, and studs. Includes 3"x2" tail pieces, 3" ridged gaskets.

Incoloy Element

26-1001-5S-K - 4.0kW/240V

Replaces:

E2400-1001, F2400-1001, 58042



Marquis Spas

Flo-Thru heater assembly, 2.25"x 12", 304SS, PSI tap, with cover plate, and studs. Includes 2"x2" tail pieces, 2" ridged gaskets.

Incoloy Element

26-C2278-1-5S-K - 4.0kW/240V

Replaces:

C2400-C2278-1, MRQ740-0584



Nuwave Spas

Flo-Thru heater assembly, 2.25"x 19.25", 304SS, PSI tap, with cover plate, and studs. Includes 2"x2" tail pieces, 2" ridged gaskets.

Incoloy Element

- (A) 26-0213N-4S-K - 3.0kW/240V
- (A) 26-0213N-5S-K - 4.0kW/240V
- (A) 26-0213N-7S-K - 5.5kW/240V
- (B) 26-0313N-5S-K - 4.0kW/240V
- (B) 26-0313N-7S-K - 5.5kW/240V

Replaces:

- (3.0kW, 19.25) C2300-0213N
- (4.0kW, 19.25") C2400-0213N
- (5.5kW, 19.25") C2550-0213N,
- C2550-0113, 20-00406, B24055C
- (4.0kW, 15") C2400-0313N
- (5.5kW, 15") C2550-0313N, 20-00348,
- B24055C1, 20-00348-C

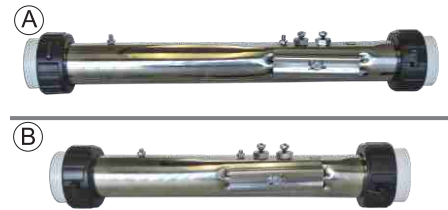

Saratoga

Flo-Thru heater assembly, 3" x 13.5", 304SS, with junction box, cover plate and studs. Includes 2"x2" tail pieces, 2" ridged gaskets.

Replaces:

- E2550-0520, E2550-0520ET

Titanium Element

- 26-0520-7T-K - 5.5kW/240V



Saratoga

Flo-Thru heater assembly, 2.25" x 13.5", 304SS, PSI tap, with cover plate, studs. Includes 2"x 3/4" Barb, 90° elbow tailpieces, 2" ridged gaskets.

Incoloy Element

- 26-H3037-5S-K - 4.0kW/240V

Replaces:

- C2400-C3037-2, C2400-C3037, E2400-0320ET,
- E2400-0320, E2400-0320+, E2400-0420ET,
- E2400-0421ET, 20-00540, E2400-0540ET



SBSG AP-1/LX-15/Sundance

Flo-Thru heater assembly, 2.25"x 15", 304SS, PSI tap, with cover plate, and studs. Includes 2"x2" tail pieces, 2" ridged gaskets. SBSG AP-1, LX-15

Incoloy Element

- 26-0056-2S-K - 2.0kW/240V
- 26-0056-3S-K - 2.5kW/240V
- 26-0056-4S-K - 3.0kW/240V
- 26-0056-5S-K - 4.0kW/240V
- 26-0056-7S-K - 5.5kW/240V

Replaces:

- (2.0kW) C2200-0056(ET) (2.5kW) C2250-0056(ET)
- (3.0kW) C2300-0056 (ET) (4.0kW) B24040Q, C2400-0056(ET), C2400-0456(ET), 20-00354 (5.5kW) 20-00227, B24055Q, C2550-0056(ET), C2550-0456(ET)
- C2550-0556, 26-0556-7S-K

Titanium Element

- 26-0056-2T-K - 2.0kW/240V
- 26-0056-3T-K - 2.5kW/240V
- 26-0056-4T-K - 3.0kW/240V
- 26-0056-5T-K - 4.0kW/240V
- 26-0056-7T-K - 5.5kW/240V



Universal Rite-Fit Replacement

- 27-J0425-2S-K - 2.0kW/240V
- 27-J0425-3S-K - 2.5kW/240V
- 27-J0425-4S-K - 3.0kW/240V
- 27-J0425-5S-K - 4.0kW/240V
- 27-J0425-7S-K - 5.5kW/240V

Sundance/SBSG AP-4/LX10

Flo-Thru heater assembly, 2.25"x 12", 304SS, PSI tap, with cover plate, and studs. Includes 2"x2" tail pieces, 2" ridged gaskets. SBSG AP-4, LX-10

Incoloy Element

- 26-1002-3S-K - 2.5kW/240V
- 26-1002-4S-K - 3.0kW/240V
- N/A
- 26-1002-5S-K - 4.0kW/240V
- 26-1002-7S-K - 5.5kW/240V

Replaces:

- (2.5kW) C2250-1002(ET) (3.0kW) C2300-1002(ET)
- (3.6kW) C2360-1002(ET) (4.0kW) 48-3600-10-002H,
- 6000-155, C2400-1002(ET), AP-4, LX-10
- (5.5kW) C2550-1002(ET), 48-3300-10-002H,
- 48-3300-10-003H

Titanium Element

- 26-1002-3T-K - 2.5kW/240V
- 26-1002-4T-K - 3.0kW/240V
- 26-1002-AT-K - 3.6kW/240V
- 26-1002-5T-K - 4.0kW/240V
- 26-1002-7T-K - 5.5kW/240V



Sundance/Jacuzzi

Flo-Thru heater assembly, 2.25"x 15", 316L, junction box with hi-limit, 48" cord and studs. Includes stands, 2"x2" tail pieces, and 2" ridged gaskets.

Replaces:

- (5.5kW) C2550-0316Ti, 20138-001

Titanium Element

- 26-0316-AP-KB - 3.6kW/240V
- 26-0316-MP-KB - 5.5kW/240V



Thermo Spas / Coleman

Flo-Thru heater assembly, 2.25"x 15", 304SS, no PSI tap, with cover plate. Includes 2"x2" tail pieces, 2" ridged gaskets.

Incoloy Element

- 26-0739-5SD-K - 4.0kW/240V
- 26-0739-7SD-K - 5.5kW/240V

Replaces:

- (4.0kW) C2400-0739ET
- (5.5kW) C2550-0739ET

Titanium Element

- 26-0739-5TD-K - 4.0kW/240V
- 26-0739-7TD-K - 5.5kW/240V

Universal Rite-Fit Replacement

- 27-J0425-5S-K - 4.0kW/240V
- 27-J0425-7S-K - 5.5kW/240V



All heater assemblies are available in 316L Stainless Steel Housings.

All heater assemblies come with tail pieces and gaskets

Flo-Thru Heater Replacements

Therm Products by HydroQuip

Flo-Thru heater assembly, 2.25"x 15", Built-In Thermostat, Hi-Limit, PSI Switch & 240V 3 Wire Connection. Includes 2"x2" tail pieces, 2" ridged gaskets.

Incoloy Element

26-0000ABX-7S-K - 5.5kW/240V

Titanium Element

26-0000ABX-7T-K - 5.5kW/240V

Replaces:
C2550-0000A-BX, 48-3300-00-00



Therm Products by HydroQuip

Flo-Thru heater assembly, 2.25"x 15", 304SS, Box cover over terminals, M7 taps, 40" 3 wire cord w/connectors. Includes 2"x2" tail pieces, 2" ridged gaskets.

Incoloy Element

26-0814-7S-K - 5.5kW/240V

Titanium Element

26-0814-7T-K - 5.5kW/240V

Replaces:
C2550-0814, C2550-0814-TPS



United Spas

Flo-Thru heater assembly, 2.25"x 13.25", 304SS, with studs. Includes 2"x2" tail pieces, 2" ridged gaskets.

Incoloy Element

26-1206-4S-K - 3.0kW/240V
26-1206-5S-K - 4.0kW/240V
26-1206-7S-K - 5.5kW/240V

Titanium Element

26-1206-4T-K - 3.0kW/240V
26-1206-5T-K - 4.0kW/240V
26-1206-7T-K - 5.5kW/240V

Replaces:
(3.0kW) C2300-1206
(4.0kW) C2400-1206
(5.5kW) C2550-1206, C2550-1206-A



United Spas

Flo-Thru heater assembly, 2.25"x 15", 304SS, cover plate. Includes 2"x2" tail pieces, 2" ridged gaskets.

Incoloy Element

26-1227-5S-K - 4.0kW/240V
26-1227-7S-K - 5.5kW/240V

Titanium Element

26-1227-5T-K - 4.0kW/240V
26-1227-7T-K - 5.5kW/240V

Replaces:
(4.0kW) C2400-1227
(5.5kW) C2550-1227



Waterway

Flo-Thru heater assembly, 2.25"x 15", 304SS, M7 taps, with studs. Includes 2"x2" tail pieces, 2" ridged gaskets.

Incoloy Element

26-0808-5SD-K - 4.0kW/240V
26-0808-7SD-K - 5.5kW/240V

Titanium Element

26-0808-5TD-K - 4.0kW/240V
26-0808-7TD-K - 5.5kW/240V

Replaces:
C2550-0808, 775-5001



Universal Rite-Fit Replacement

27-J0425-7S-K - 5.5kW/240V
27-J0425-5S-K - 4.0kW/240V

Balboa® OEM Heater Replacements

Balboa® BP M7 Plug-n-Click

Flo-Thru heater assembly, 2.25"x 15", 304SS, with M7 sensors, and Plug-n-Click Harness, Includes 2"x2" tail pieces, 2" ridged gaskets.

Incoloy Element

26-58303-K - 4.0kW/240V
26-58306-K - 5.5kW/240V

Titanium Element

26-58305-K - 4.0kW/240V
26-58308-K - 5.5kW/240V

Replaces:

(4.0kW) 58303 (Ti)58305
(5.5kW) 58306 (Ti)58308



with VS Heater Harness*

Incoloy Element

26-58303-KH - 4.0kW/240V
26-58306-KH - 5.5kW/240V

Titanium Element

26-58305-KH - 4.0kW/240V
26-58308-KH - 5.5kW/240V

Replaces:

(4.0kW) 55625, 55033, 55035, 58031, 58056, 58064, 58104, 58106, 58109, 58117, 58120, 58148, 58212, C2400-0807-TPS
(5.5kW) 55624, 58000, 58010, 58083, 58086, 58089, 58105, 58121, 58123, 58209, C2550-0807-TPS



*Added harness to convert to a VS heater replacement.



Balboa®

Flo-Thru heater assembly, 2.25"x 15", 304SS, PSI tap, with cover plate. Includes 2"x2" tail pieces, 2" ridged gaskets.

Incoloy Element

26-50081-K - Replaced by 26-0535-5S-K(see Pg.93)
 26-50080-K - Replaced by 26-0535-7S-K(see Pg.93)

Replaces:

(4.0kW) 50081, BAL50081, C2400-0535, 48-3300-10-435H
 (5.5kW) 50080, C2550-0535



Balboa®

Flo-Thru heater assembly, 2.25"x 15", 304SS, with PSI & guard, with cover plate. Includes 2"x2" tail pieces, 2" ridged gaskets.

Incoloy Element

26-58081-K - Replaced by 26-0535-5S-KP(see Pg.93)
 26-50096-K - Replaced by 26-0535-7S-KP(see Pg.93)

Replaces:

(4.0kW) 50067, 50142, 58009, 58069, 58081, C2400-0535-TPS
 (5.5kW) 50071, 50076, 50096, 50134, 50150, C2550-0535-TPS



Balboa®

Flo-Thru heater assembly, 2.25"x 15", 304SS, with PSI & guard, with cover plate. Includes 2"x2" tail pieces, 2" ridged gaskets.

Incoloy Element

26-58001-K - 4.0kW/240V

Replaces:

(4.0kW) 58001, 58004, 52009, 52010, 52099, 52108, C2400-0835



Balboa®

Flo-Thru heater assembly, 2.25"x 15", 304SS, M7 taps, with studs. Includes 2"x2" tail pieces, 2" ridged gaskets.

Incoloy Element

26-58032-K - Replaced by 26-58104-K(see Pg.93)
 26-58002-K - Replaced by 26-58083-K(see Pg.93)

Replaces:

(4.0kW) 58032, 58103, C2400-0807
 (5.5kW) 58002, 58016, C2550-0807



Balboa® M7

Flo-Thru heater assembly, 2.25"x 15", 304SS, with M7 sensors, and studs. Includes 2"x2" tail pieces, 2" ridged gaskets.

Incoloy Element

26-58138-K - 1.5kW/240V
 26-58145-K - 2.0kW/240V
 26-58118-K - 3.0kW/240V
 26-58104-K - 4.0kW/240V
 26-58083-K - 5.5kW/240V

Titanium Element

26-55628-K - 1.5kW/240V
 26-55627-K - 2.0kW/240V
 26-55626-K - 3.0kW/240V
 26-55625-K - 4.0kW/240V
 26-55624-K - 5.5kW/240V

Replaces:

(1.5kW) 55628, 58138
 (2.0kW) 55627, 58145, 55881
 (3.0kW) 55626, C2300-0807-TPS, 58061
 (4.0kW) 55625, 55033, 55035, 58031, 58056, 58064, 58104, 58106, 58109, 58117, 58120, 58148, 58212, C2400-0807-TPS
 (5.5kW) 55624, 58000, 58010, 58083, 58086, 58089, 58105, 58121, 58123, 58209, C2550-0807-TPS



Balboa®

Flo-Thru heater assembly, 2.25"x 15", 304SS, PSI tap, and sensor tap. Includes 2"x2" tail pieces, 2" ridged gaskets.

Incoloy Element

26-58029-K - Replaced by 26-0809-5S-K(see Pg.93)
 26-58027-K - Replaced by 26-0809-7S-K(see Pg.93)

Replaces:

(4.0kW) 58029, C2400-0809
 (5.5kW) 58027, C2550-0809(-1)



Balboa®

Flo-Thru heater assembly, 2.25"x 15", 304SS, with PSI switch and sensor tap. Includes 2"x2" tail pieces, 2" ridged gaskets.

Incoloy Element

26-58048-K - Replaced by 26-0809-5S-KSP(see Pg.93)
 26-58019-K - Replaced by 26-0809-7S-KSP(see Pg.93)

Replaces:

(4.0kW) 53349, 58028, 58048, 58067, C2400-0809-TPS
 (5.5kW) 58019, 58026, 58066, 58074, C2550-0809-TPS



Balboa® VS100

Flo-Thru heater assembly, 1.5"x 10", VS100, w/M7 Sensors, Includes 1.5"x 1.5" tail pieces, 2" ridged gaskets.

Incoloy Element

26-58198-K - Replaced with 26-58203-K
 26-58203-K - 4.0kW/240V, 1.0kW/120V

Replaces:

(1.0kW) 58198, 58205
 (4.0kW) 26-0020A, 58203, 58198



Balboa® Auxiliary Heater

Balboa Auxiliary Heater 5.5 kW. This auxiliary heater is plumbed in series with the main spa pack heater and adds 5.5 kW of additional heating power.

Replaces:

(5.5kW) 58132, 58182



Balboa Pt#	HydroQuip Pt#	Description
58132	26-58132	5.5KW Auxiliary Heater / Same as 58182

Balboa® Revolution Heater

Balboa Revolution Heater 4.0 kW. For BP1500 Unit.

Replaces:

(4.0kW) 55691

Balboa Pt#	HydroQuip Pt#	Description
55691	26-55691-K	4.0KW Revolution Heater Assembly



Artesian / Majestic

Vertical Low Flow 13" x 3" with bulkhead coated element with box, cord and 3/4" barb



Known Part Numbers:
(4.0kW) E2400-0114(ET),
 E2400-0014(ET), 48-3600-40-014
(5.5kW) E2550-0114(ET), E2550-0014,
 C2550-0014ET

[Replace with Universal Vertical Low Flow Heater:](#)
 See Page 84 for All Part Numbers

Therm Products

Vertical Low Flow 10" x 3" with 1" x 1" barb and pressure switch and bare cord



Known Part Numbers:
(4.0kW) E2400-0028C, 26-08108,
 26-08118, 26-08119, 26-08109
(5.5kW) E2550-0028C, 26-08112,
 26-08116, 26-08103, 26-08106

[Replace with Universal Vertical Low Flow Heater:](#)
 See Page 84 for All Part Numbers

Dimension One / Crystal

Vertical Low Flow 10" x 3" with 1 1/2" snap nut



Known Part Numbers:
(2.0kW) E2200-0004
(4.0kW) E2400-0004, 48-3600-40-004

DISCONTINUED

Therm Products

Vertical Low Flow 9.5" x 3" with pressure switch



Known Part Numbers:
(5.5kW) E2550-0029C, 26-08107,
 26-00107

[Replace with Universal Vertical Low Flow Heater:](#)
 See Page 84 for All Part Numbers

Dynasty

Vertical Low Flow 12" x 3" with box and pressure switch, 1" barb, 1" socket



Known Part Numbers:
(4.0kW) 26-081214, 26-00155, 26-08145,
 26-08146, 26-08159, 26-08157
(5.5kW) E2550-0120C, 26-08125, 26-08147,
 26-08120, 26-08153, 26-08155, 26-08156

[Replace with Universal Vertical Low Flow Heater:](#)
 See Page 84 for All Part Numbers

Therm Products

Vertical Low Flow 13" x 3" with wires and fork connectors



Known Part Number:
(2.7kW) E2270-3314
(5.5kW) E2550-3314

[Replace with Universal Vertical Low Flow Heater:](#)
 See Page 84 for All Part Numbers

Gatsby

Vertical Low Flow 10" x 7" with pressure switch and cord



Titanium Element
28-E0300-4T-K - 3.0kW, 240V
28-E0300-5T-K - 4.0kW, 240V
28-E0300-7T-K - 5.5kW, 240V

Replaces:
(3.0kW) E2300-0300ET
(4.0kW) E2400-0300ET, 26-08174,
 E2400-0301ET
(5.5kW) E2550-0300ET, 26-08175,
 E2550-0301ET

Maax Spas

Vertical Low Flow 9.5" x 3" with pressure switch, 1" barbs, amp plug and cords



Known Part Numbers:
(3.0kW) 26-08116
(4.0kW) 26-08114, 26-08115, 26-08102

[Replace with Universal Vertical Low Flow Heater:](#)
 See Page 84 for All Part Numbers

Maax Spas

Vertical Low Flow 15" x 3" dual element with pressure switch



Known Part Numbers:
(3.6kW) 26-08235, 26-08245

[Replace with Universal Vertical Low Flow Heater:](#)
 See Page 84 for All Part Numbers

Introducing the new Universal Vertical Low Flow Heater which replaces every heater listed on this page.



See page 3 for more details

Artesian / Majestic

Vertical Low Flow 13" x 3" with bulkhead coated element and 3/4" barb



Known Part Numbers:
(2.0kW) E2200-0115(ET), E2200-0015(ET)
(4.0kW) E2400-0115(ET), E2400-0015, E2400-0015ET
(5.5kW) E2550-0115(ET), E2550-0015, E2550-0015ET

Replace with Universal Vertical Low Flow Heater:
 See Page 3 for All Part Numbers

Caldera

Vertical Low Flow 11" x 3" with 2 thermo-wells and 3/4" barb



Known Part Numbers:
(2.0kW) E2200-0001
(5.5kW) E2550-0001, 48-3300-40-001

Replace with Universal Vertical Low Flow Heater:
 See Page 84 for All Part Numbers

Caldera

Vertical Low Flow 11" x 3" with 3/4" barb



Known Part Numbers:
(4.0kW) E2400-0101(ET), 48-3300-40-101
(5.5kW) E2550-0101

Replace with Universal Vertical Low Flow Heater:
 See Page 84 for All Part Numbers

Caldera

Vertical Low Flow 11" x 3" with 3/4" barb



Known Part Numbers:
(2.0kW) E2200-0201(ET)
(4.0kW) E2400-0201(ET)

Replace with Universal Vertical Low Flow Heater:
 See Page 84 for All Part Numbers

Clearwater Spas

Vertical Low Flow 10" x 3" with 1" barbs



Known Part Numbers:
(1" Barb) E2400-0021-NP, E2400-0021ET, E2400-0021, E2400-0021ET-1, 26-00110
(3/4" Barb) E2400-0221

Replace with Universal Vertical Low Flow Heater:
 See Page 84 for All Part Numbers

Dimension One

Vertical Low Flow 10" x 3" with 3/4" barbs



Known Part Numbers:
(2.0kW) E2200-0003
(4.0kW) E2400-0003, 48-3600-40-003

Replace with Universal Vertical Low Flow Heater:
 See Page 3 for All Part Numbers

DM / Vita Spas

Vertical Low Flow 11" x 3" with 2 PSI Taps and 3/4" barb



Known Part Numbers:
(2.5kW) E2250-0127ETX
(3.0kW) E2300-0127ET(X), E2300-0126ET
(4.0kW) E2400-0127ET(X), E2400-1127ET, E2400-0126ET, E2400-0026, E2400-1127
(4.5kW) E2450-0127ET(X), E2450-1127ET

Replace with Universal Vertical Low Flow Heater:
 See Page 84 for All Part Numbers

Gatsby / Hurricane / Leisure Bay

Vertical Low Flow 9" x 3" with 1" barb and 12" Wires, coated element.



Known Part Numbers:
(2.5kW) E2250-0204(ET)
(4.0kW) E2400-0202ET, E2400-0202-1, E2400-0204, E2400-0204ET
(5.5kW) E2550-0202(ET), E2550-0202-1, E2550-0202ET-1, E2550-0204, E2550-0204ET, E2550-0102ET, 26-00141

Replace with Universal Vertical Low Flow Heater:
 See Page 84 for All Part Numbers

Introducing the new Universal Vertical Low Flow Heater which replaces every heater listed on this page.

If your spa heater assembly is mounted on the side of the control box we have a Universal Vertical Low Flow Heater Assembly which can be used as a retro-fit replacement utilizing the optional side mounting kit. In addition, we offer a number of other optional accessories for a successful retro-fit.

Example of the Universal Vertical Low Flow Heater mounted on a typical control box below.

Optional Side Mounting Kit Part# 48-0304-K



See page 3 for more details

Gatsby / Hurricane / Leisure Bay

Vertical Low Flow 9" x 3" with 1" barb and 12" Wires, coated element.



Known Part Numbers:
 (4.0kW) E2400-0203(ET)
 (5.5kW) E2550-0203(ET)

Replace with Universal Vertical Low Flow Heater:
 See Page 84 for All Part Numbers

Maax Spas / Savannah

Vertical Low Flow 10" x 3"



Known Part Numbers:
 (4.0kW) 26-00257, 26-00254
 (5.5kW) 26-00255

Replace with Universal Vertical Low Flow Heater:
 See Page 84 for All Part Numbers

Nu Wave

Vertical Low Flow 9.5" x 1.5"



Known Part Numbers:
 (4.0kW) E2400-0007, 20-00514

Replace with Universal Vertical Low Flow Heater:
 See Page 84 for All Part Numbers

Pinnacle

Vertical Low Flow 10" x 3"



Known Part Numbers:
 (4.0kW) E2400-0027

Replace with Universal Vertical Low Flow Heater:
 See Page 84 for All Part Numbers

Pinnacle / Leisure Bay / Hurricane

Vertical Low Flow 9" x 3" with 1" barbs and wire studs



Known Part Numbers:
 (2.5kW) E2250-020X(-1)
 (5.5kW) E2550-020X(ET), E2550-020X-1,
 26-00100, 48-3300-40-020

Replace with Universal Vertical Low Flow Heater:
 See Page 84 for All Part Numbers

Saratoga

Vertical Low Flow 13.5" x 3"



Known Part Numbers:
 (4.0kW) E2400-0420ET, E2400-0421ET,
 20-00540, E2400-0320(ET), 20-0320ET+
 (5.5kW) E2550-0320(ET),
 E2550-0320ET+

Replace with :
 (4.0kW) 26-H3037-5S-K - 4.0kW/240V
 (5.5kW) 26-0520-7T-K - 5.5kW/240V
 (See Page 85)

Saratoga

Vertical Low Flow 3kW, 13" x 3" with 3/4" barb and dual element



Known Part Numbers:
 (3.0kW) E2300-0542ET, E2300-0321,
 E2300-0321ET, 20-00542

Replace with Universal Vertical Low Flow Heater:
 See Page 84 for All Part Numbers

SBSG

Vertical Low Flow 9" x 3" with 1" barb and dual element



Known Part Numbers:
 (4.0kW) E2400-0351(ET)
 (5.5kW) E2550-0351(ET)

Replace with Universal Vertical Low Flow Heater:
 See Page 84 for All Part Numbers

SBSG

Vertical Low Flow 11" x 3"



Known Part Numbers:
 (2.5kW) E2250-0012
 (2.7kW) E2270-0012
 (3.0kW) E2300-0012
 (4.0kW) E2400-0012
 (5.5kW) E2550-0012

Replace with Universal Vertical Low Flow Heater:
 See Page 84 for All Part Numbers

Sundance

Vertical Low Flow 13" x 3.5" with 3/4" barbs



Known Part Numbers:
 (2.7kW) E2270-1000
 (5.5kW) E2550-1000, C2783-1

Replace with :
 (2.7kW) 26-315-U-K - 2.7kW/240V, Export
 (5.5kW) 26-310-U-K - 5.5kW/240V
 See Page 87

Introducing the new Universal Vertical Low Flow Heater which replaces every heater listed on this page.

If your spa heater assembly is mounted on the side of the control box we have a Universal Vertical Low Flow Heater Assembly which can be used as a retro-fit replacement utilizing the optional side mounting kit. In addition, we offer a number of other optional accessories for a successful retro-fit.

Example of the Universal Vertical Low Flow Heater mounted on a typical control box below.

Optional Side Mounting Kit Part# 48-0304-K



See page 14 for more details

Used on Controls & Equipment Systems Manufactured by Hydro-Quip

Air Slide 6000 Series

Slide heater, 2.25"x 15", 304SS, PSI switch, auto-reset H/L, 30" cords. Includes 2"x2" tail pcs, 2" ridged gaskets.

Replacement Heater for:
HQ Air Slide Series CS6009

Incoloy Element

26-85B-S80-1FM3 - 4.0kW/240V
26-86B-S80-1FM3 - 4.5kW/240V
26-87B-S80-1FM3 - 5.5kW/240V

Titanium Element

26-8PB-S80-1FM3 - 4.0kW/240V
26-8QB-S80-1FM3 - 4.5kW/240V
26-8RB-S80-1FM3 - 5.5kW/240V



Air Versi-Heat 6000 Series

Versi-Heat assy, 2.25"x 15", 304SS, PSI switch, auto-reset H/L, 60" cords. Includes 2"x2" tail pcs, 2" ridged gaskets.

Replacement Heater for:
HQ Air Versi-Heat Series CS6008

Incoloy Element

26-85B-080-1PM3 - 4.0kW/240V
26-86B-080-1PM3 - 4.5kW/240V
26-87B-080-1PM3 - 5.5kW/240V

Titanium Element

26-8PB-080-1PM3 - 4.0kW/240V
26-8QB-080-1PM3 - 4.5kW/240V
26-8RB-080-1PM3 - 5.5kW/240V



Air Slide 4000 Series

Slide heater, 2.25"x 17", "L" shaped, 304SS, PSI switch, auto-reset H/L, 30" cords. Includes 2"x2" tail pieces, 2" ridged gaskets.

Replacement Heater for:
Air Slide Series CS4009

Incoloy Element

26-65B-S80-1FM3 - 4.0kW/240V
26-66B-S80-1FM3 - 4.5kW/240V
26-67B-S80-1FM3 - 5.5kW/240V

Titanium Element

26-6PB-S80-1FM3 - 4.0kW/240V
26-6QB-S80-1FM3 - 4.5kW/240V
26-6RB-S80-1FM3 - 5.5kW/240V



Air Versi-Heat 4000 Series

Versi-Heat heater, 2.25"x 17", 304SS, "L" shaped, PSI switch, auto-reset H/L, 60" cords. Includes 2"x2" tail pieces, 2" ridged gaskets.

Replacement Heater for:
Air Versi-Heat Series CS4008

Incoloy Element

26-65B-080-1PM3 - 4.0kW/240V
26-66B-080-1PM3 - 4.5kW/240V
26-67B-080-1PM3 - 5.5kW/240V

Titanium Element

26-6PB-080-1PM3 - 4.0kW/240V
26-6QB-080-1PM3 - 4.5kW/240V
26-6RB-080-1PM3 - 5.5kW/240V



Air 800 Series

Cs800 heater, 2.25"x 15", 304SS, PSI tap, cover plate and studs. Includes 2"x2" tail pcs, 2" ridged gaskets.

Replacement Heater for:
CS800 Air Series Systems
Also Replaces: 26-0047

Incoloy Element

26-0047-K - 5.5kW/240V

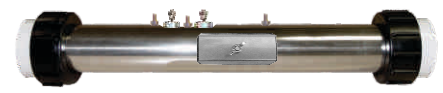

Air 1001 Series

Cs1001 heater, 2.25"x 15", 304SS, PSI tap, cover plate and H/L studs. Includes 2"x2" tail pcs, 2" ridged gaskets.

Replacement Heater for:
HQ/CS1001 Air Series Systems
Replaces:

Incoloy Element

48-260036-R1 - Obsolete, use: 27-J0519-5T-K*
48-260034-R1 - Obsolete, use: 27-J0519-6T-K*
48-260032-R1 - Obsolete, use: 27-J0519-7T-K*

(4.0kW) 26-0036-R1, C2400-0309ET
(4.5kW) 26-0034-R1, C2450-0309ET
(5.5kW) 26-0032-R1, C2550-0309ET



*See page 10.2 for heater details

All heater assemblies come with tail pieces and gaskets



Used on Controls & Equipment Systems Manufactured by Hydro-Quip

Balboa® WaterPro 6000B Series

Flo-Thru heater assembly, 2.25"x 15", 304SS, M7 taps, with studs. Includes 2"x2" tail pieces, 2" ridged gaskets.

Replacement Heater for:
Balboa® Series/WaterPro ES6000B/CS6100B, 6200B, 6220B, 6230B, 6330B

Incoloy Element

26-0071-M7-K - 5.5kW/240V

Titanium Element

26-0071-F-M7-K - 5.5kW/240V



Balboa® WaterPro 6000B Series

Flo-Thru heater assembly, 2.25"x 15", 304SS, with M7° sensors, and studs. Includes 2"x2" tail pieces, 2" ridged gaskets.

Replacement Heater for:
Balboa® Series/WaterPro ES6000B/CS6100B 6200B, 6220B, 6230B, 6330B

Incoloy Element

26-0071-M7-KS - 5.5kW/240V

Titanium Element

26-0071-F-M7-KS - 5.5kW/240V



Balboa® Slide 6000B Series

Slide heater assembly, 2.25"x 15", 304SS, with M7° sensors, 30" cords. Includes 2"x2" tail pieces, 2" ridged gaskets.

Replacement Heater for:
Balboa® Slide Series CS6109B, 6209B, 6229B, 6239B, 6339B

Incoloy Element

26-85M-S00-1F03 - 4.0kW/240V
26-87M-S00-1F03 - 5.5kW/240V

Titanium Element

26-8QM-S00-1F03 - 4.0kW/240V
26-8RM-S00-1F03 - 5.5kW/240V



Balboa® Versi-Heat 6000B Series

Versi-Heat heater assembly, 2.25"x 15", 304SS, with M7° sensors, 60" cords. Includes 2"x2" tail pieces, 2" ridged gaskets.

Replacement Heater for:
Balboa® Versi-Heat Series CS6108B, 6208B, 6228B, 6238B, 6338B

Incoloy Element

26-86M-000-1P03 - 4.5kW/240V
26-87M-000-1P03 - 5.5kW/240V

Titanium Element

26-8QM-000-1P03 - 4.5kW/240V
26-8RM-000-1P03 - 5.5kW/240V



Balboa® Slide 4000B Series

Slide heater assembly, 2.25"x 17", 304SS, "L" shaped, with M7° sensors, 30" cords. Includes 2"x2" tail pieces, 2" ridged gaskets.

Replacement Heater for:
Balboa® Slide Series CS4109B, 4209B, 4229B, 4239B, 4339B

Incoloy Element

26-67M-S00-1F03 - 5.5kW/240V

Titanium Element

26-6RM-S00-1F03 - 5.5kW/240V

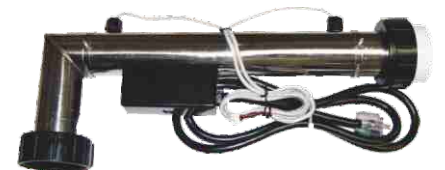

Balboa® Versi-Heat 4000B Series

Slide heater assembly, 2.25"x 17", 304SS, "L" shaped, with M7° sensors, 60" cords. Includes 2"x2" tail pieces, 2" ridged gaskets.

Replacement Heater for:
Balboa® Slide Series CS4108B, 4208B, 4228B, 4238B, 4338B

Incoloy Element

26-67M-000-1PP3 - 5.5kW/240V

Titanium Element

26-6RM-000-1PP3 - 5.5kW/240V



All heater assemblies come with tail pieces and gaskets



Used on Controls & Equipment Systems Manufactured by Hydro-Quip

Gecko WaterPro 6000 Series

Flo-Thru heater assembly, 2.25"x15", 304SS, PSI tap, cover plate with studs. Includes 2"x2" tail pieces, 2" ridged gaskets.

Replacement Heater for:

Gecko Series WaterPro ES6000 / CS6200, 6220, 6230, 6330

Also Replaces:

26-0032, 26-0032-R1C, 26-0032A, 26-0058, 26-0071

Incoloy Element

26-0071B-K - 4.0kW/240V
26-0071A-K - 4.5kW/240V
26-0071-K - 5.5kW/240V

Titanium Element

26-0071B-F-K - 4.0kW/240V
26-0071A-F-K - 4.5kW/240V
26-0071-F-K - 5.5kW/240V



Gecko WaterPro 6000 Series

Flo-Thru heater assembly, 2.25"x15", 304SS, PSI tap, cover plate with studs. Includes 2"x2" tailpieces, 2" ridged gaskets. For fixed heater units with front access brackets.

Universal Rite-Fit Replacement

27-J0519-5S-K - 4.0kW/240V
27-J0519-7S-K - 5.5kW/240V

Incoloy Element

26-0079B-K - 4.0kW/240V
26-0079-K - 5.5kW/240V



Gecko WaterPro 7000 Series

Flo-Thru heater assembly, 2.25"x15", 304SS, PSI tap, cover plate with studs. Includes 2"x2" tail pieces, 2" ridged gaskets.

Replacement Heater for:

Gecko Series WaterPro CS7500

Incoloy Element

26-0071-5KSS-K - 4.0kW/240V
26-0071-7KSS-K - 5.5kW/240V

Titanium Element

26-0071-F-5KSS-K - 4.0kW/240V
26-0071-F-7KSS-K - 5.5kW/240V



Gecko Slide 6000/7000 Series

Slide heater assembly, 2.25"x15", 304SS, PSI switch, 30" cords. Includes 2"x2" tail pieces, 2" ridged gaskets.

Replacement Heater for:

Gecko Slide Series CS6209, 6229, 6239, 6339, 7509

Incoloy Element

26-85B-S00-1FP3 - 4.0kW/240V
26-86B-S00-1FP3 - 4.5kW/240V
26-87B-S00-1FP3 - 5.5kW/240V

Titanium Element

26-8PB-S00-1FP3 - 4.0kW/240V
26-8QB-S00-1FP3 - 4.5kW/240V
26-8RB-S00-1FP3 - 5.5kW/240V



Gecko Versi-Heat 6000/7000 Series

Versi-Heat heater assembly, 2.25"x15", 304SS, PSI switch, 60" cords. Includes 2"x2" tail pcs, 2" ridged gaskets.

Replacement Heater for:

Gecko Versi-Heat Series CS6208, 6228, 6238, 6338

Incoloy Element

26-85B-000-1PP3 - 4.0kW/240V
26-86B-000-1PP3 - 4.5kW/240V
26-87B-000-1PP3 - 5.5kW/240V

Titanium Element

26-8PB-000-1PP3 - 4.0kW/240V
26-8QB-000-1PP3 - 4.5kW/240V
26-8RB-000-1PP3 - 5.5kW/240V



Gecko Slide 4000 Series

Slide heater assy, 2.25"x17", "L" shaped, 304SS, PSI switch, 30" cords. Includes 2"x2" tail pieces, 2" ridged gaskets.

Replacement Heater for:

Gecko Slide Series CS4209, 4229, 4239, 4339

Incoloy Element

26-65B-S00-1FP3 - 4.0kW/240V
26-66B-S00-1FP3 - 4.5kW/240V
26-67B-S00-1FP3 - 5.5kW/240V

Titanium Element

26-6PB-S00-1FP3 - 4.0kW/240V
26-6QB-S00-1FP3 - 4.5kW/240V
26-6RB-S00-1FP3 - 5.5kW/240V



All heater assemblies come with tail pieces and gaskets

Used on Controls & Equipment Systems Manufactured by Hydro-Quip

Gecko Versi-Heat 4000 Series

Versi-Heat heater assy, 2.25"x 17", 304SS, "L" shaped, PSI switch, 60" cords. Includes 2"x2" tail pcs, 2" ridged gaskets.

Replacement Heater for:
Gecko Slide Series CS4208, 4228, 4238, 4338

Incoloy Element

26-65B-000-1PP3 - 4.0kW/240V
26-66B-000-1PP3 - 4.5kW/240V
26-67B-000-1PP3 - 5.5kW/240V

Titanium Element

26-6PB-000-1PP3 - 4.0kW/240V
26-6QB-000-1PP3 - 4.5kW/240V
26-6RB-000-1PP3 - 5.5kW/240V



Gecko Slide 9700 Series

Slide heater assembly, 2.25"x 16.25", 304SS, PSI switch, 30" cords. Includes 2"x2" tail pieces, 2" ridged gaskets.

Replacement Heater for:
Gecko Slide Series CS9709 - After February 2014

Incoloy Element

26-K5B-S50-1FP3 - 4.0kW/240V
26-K6B-S50-1FP3 - 4.5kW/240V
26-K7B-S50-1FP3 - 5.5kW/240V

Titanium Element

26-KPB-S50-1FP3 - 4.0kW/240V
26-KQB-S50-1FP3 - 4.5kW/240V
26-KRB-S50-1FP3 - 5.5kW/240V



Gecko Versi-Heat 9700 Series

Versi-Heat assembly, 2.25"x 16.25", 304SS, PSI switch, 60" cords. Includes 2"x2" tail pieces, 2" ridged gaskets.

Replacement Heater for:
Gecko Versi-Heat Series CS9708 - After February 2014

Incoloy Element

26-K5B-050-1PP3 - 4.0kW/240V
26-K6B-050-1PP3 - 4.5kW/240V
26-K7B-050-1PP3 - 5.5kW/240V

Titanium Element

26-KPB-050-1PP3 - 4.0kW/240V
26-KQB-050-1PP3 - 4.5kW/240V
26-KRB-050-1PP3 - 5.5kW/240V



Gecko Versi-Heat

Versi-Heat assembly, 2.25"x 13", 316L, PSI switch, 60" cords 3 pin & 6 pin plugs, with Hi-Limit Sensor. Includes 2"x2" tail pieces, 2" ridged gaskets.

Replacement Heater for:
22-C63-050-0G00

Incoloy Element

26-C63-050-0G00 - 4.5kW/240V



Lo-Flo Series - Laing Style Versi-Heat

Laing Trombone style, 1" tube, 25" cord, built-in Thermal Cut Out (TCO) and Slide Hardware Kit.

Replacement Heater for:
26-0091B-5T-K

Incoloy Element

26-MP0-00A-0F00 - 1" - 4.0kW/1.0kW, 240V/120V

Dimensions:

A: 5⁵/₈"
B: 15³/₄"
C: 26¹/₂"

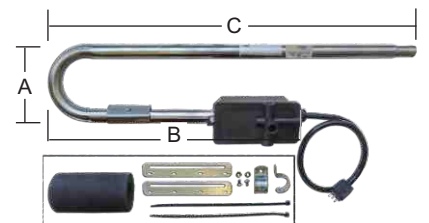

Lo-Flo Series - Laing Style Versi-Heat

Low flow heater kits for replacement of Versi-Heat heaters with 9-pin plug adapters. Includes Flow switch kit or PSI Switch, 6.5" pre-installed cord with ring terminals

26-0066A-KIT-FS - **Obsolete, use:**

26-3478-1A-BT-F - 2.7kW/240V

26-0066A-KIT-PS - **Obsolete, use:**

26-3478-1A-BT-P - 2.7kW/240V

26-0066-KIT-FS - **Obsolete, use:**

26-3229-2A-7T-F - 5.5kW/240V

26-0066-KIT-PS - **Obsolete, use:**

26-3229-2A-7T-P - 5.5kW/240V

Dimensions:

A: 10⁵/₈"
B: 13³/₄"
C: 23¹/₂"

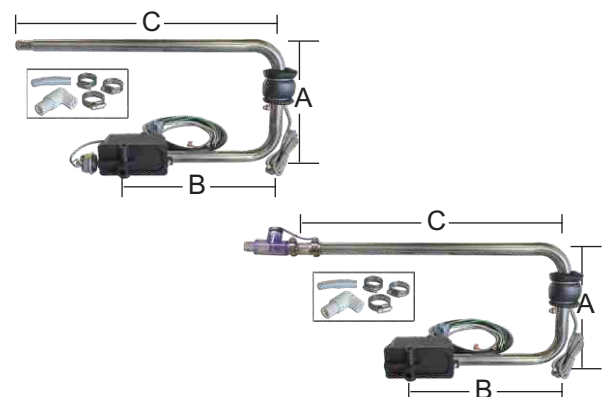

All heater assemblies come with tail pieces and gaskets



Outdoor Balboa Series - ES/CS87/8800

Outdoor heater assembly, 2.25"x 19.25", 316L, M7° sensors, and studs. Includes 2"x2" tail pieces, 2" ridged gaskets.

Replacement Heater for:
ES/CS8700, 8800 11kW & 5.5kW Outdoor Series Systems



Titanium Element

- 26-0053-F-M7-KS - 5.5kW/240V
- 26-0054AF-M7-KS - 11kW/240V - Dual Elements

Outdoor Balboa Series - ES/CS87/8800 Gas Ready

Outdoor heater assembly, 2.25"x 19.25", 304SS, M7 sensors, studs, no heater element. Includes 2"x2" tail pieces, 2" ridged gaskets.

Replacement Heater for:
ES/CS8700, 8800 Gas Ready Outdoor Series Systems



No Element - Gas Ready Systems

- 26-0063-XD-KS - with M7 Sensors
- 26-0063-XD-K - without Sensors

Outdoor Gecko Y Series - ES/CS8900

Outdoor heater assembly, 2.25"x 19.25", 316L, in.flo sensors, studs. Includes 2"x2" tail pieces, 2" ridged gaskets.

Replacement Heaters for:
ES/CS8900 Electric & Gas Ready Outdoor Series Systems

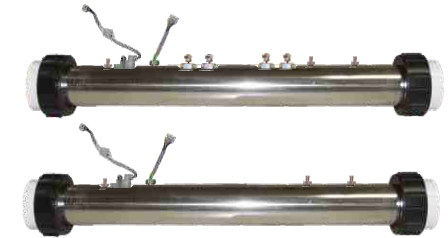

Titanium Element

- 26-0053-F-Y-KS - 5.5kW/240V - with In.Flo Sensors
- 26-0054-F-Y-KS - 11kW/240V - with In.Flo Sensors

No Element - Gas Ready Systems

- 26-0063-Y - 2.25"x19.25" - with In.Flo Sensors

Outdoor Gecko Series - ES/CS8600

Outdoor heater assembly, 2.25"x 19.25", 304SS, PSI tap, cover plate, and studs. Includes 2"x2" tail pieces, 2" ridged gaskets.

Replacement Heater for:
ES/CS8600 11 & 5.5kW Outdoor Series Systems made after June, 2010



Titanium Element

- 26-0053-K - 5.5kW/240V
- 26-0054A-K - 11kW/240V - Dual Elements

Outdoor Gecko Series - ES/CS8600

Outdoor heater assembly, 3"x 19.25", 304SS, PSI tap, cover plate, and studs. Includes 2"x2" tail pieces, 2" ridged gaskets.

Replacement Heater for:
ES/CS8600 11kW & 5.5kW Outdoor Series Systems made before June, 2010



Incoloy Element

- 26-0054-K - 11kW/240V - Dual Elements

Outdoor Series - ES/CS8600 Gas Ready

Outdoor heater assembly, 2.25"x 19.25", 304SS, PSI tap, cover plate, studs, no heater element. Includes 2"x2" tail pieces, 2" ridged gaskets.

Replacement Heater for:
ES/CS8600 Gas Ready Outdoor Series Systems



No Element - Gas Ready Systems

- 26-0063-XD-KP - No Element

Outdoor Series - Heatmax 11kW

Heatmax 2.25" 304SS, "U" shaped heater assembly, 2.25", PSI tap, cover plate. Includes 2"x2" tail pieces, 2" ridged gaskets.

Replacement Heater for:
Heatmax RHS 11kW
Also Replaces: 26-0017A



Incoloy Element

- 26-0082A-K - 5.5kW/240V

Titanium Element

- 26-0082A-F-K - 11kW/240V - Dual Elements

Outdoor Series - Heatmax 5.5kW

Heatmax 2.25" 304SS, "U" shaped heater assembly, 2.25", PSI tap, cover plate. Includes 2"x2" tail pieces, 2" ridged gaskets.

Replacement Heater for:
Heatmax RHS 5.5kW
Also Replaces: 26-0031



Incoloy Element

- 26-0082-K - 5.5kW/240V

Titanium Element

- 26-0082-F-K - 5.5kW/240V

All heater assemblies come with tail pieces and gaskets

VH 9-Pin Retro-Fit w/Cord

Heater assembly, 2.25", 304SS, PSI switch, 60" cords. Includes 2"x2" tail pieces, 2" ridged gaskets. Does not include Hi-Limit sensor.

Incoloy Element

48-0007A 13" - 5.5kW/240V
48-0007B 15" - 5.5kW/240V

Replacement Heater for:

Older Versi-Heat heaters with 9-Pin Connector.



VH 9-Pin Retro-Fit without Cord

Heater assembly, 2.25", 304SS, PSI switch. Includes 2"x2" tail pieces, 2" ridged gaskets. Does not include Hi-Limit sensor.

Incoloy Element

48-0019 13" - 5.5kW/240V
48-0019A 15" - 5.5kW/240V

Replacement Heater for:

Older Versi-Heat heaters with 9-Pin Connector.



CS300/AP-2 Heater Housing Kit

Heater housing kit, includes ABS housing, bushing, union, and O-ring gasket.

Part Number

48-0057

Replacement Heater Housing for:

CS300 & AP-2



CS500/4000 Heater Housing Kit

Heater housing kit, includes ABS housing, bushing, union, O-ring gasket, hi-limit reset button, and cover plate.

Part Number

48-0014

Replacement Heater Housing for:

CS500 & 4000



All heater assemblies come with tail pieces and gaskets

CS300/500/4000/AP-2 Heater Housing Parts

02-0055 Rivet, Hi-Limit Reset
15-0031 Bushing, Heater Housing, Threaded
42-0005 Union, Pump, 1½"
60-0001 O-Ring, Heater, 5X5 Flange
65-0119A Plate, Cover, Heater Kits, No Slots
41-00010 Current Collector, HQ/AT



Heater Kit w/Thermostat

Heater kit, built in thermostat, PSI switch and hi-limit. Includes assorted fittings.

Part Number

48-0017A 5.5kW/240V
48-0017 4.5kW/240V

Replacement Heater for:

Brett 22-0135



Heater Kit without Thermostat

Heater kit, PSI switch and hi-limit. Includes assorted fittings.

Part Number

48-0018A 5.5kW/240V
48-0018 4.5kW/240V

Replacement Heater for:

Brett 22-0134





All universal heater elements are individually boxed to keep the element clean and protect the terminals from being damaged prior to use. A color coded packing label is used on all universal element boxes to quickly & easily identify heater wattage.

Universal Flo-Thru elements are available individually boxed or as a 24 unit Master Pack shown above.

10" Flo-Thru Side

INCOLOY PT#	TITANIUM PT#	DESCRIPTION	INCOLOY PT#	TITANIUM PT#	DESCRIPTION
12-0100-K	12-0100F-K	5.5KW, 240V, 10"	12-0104-K	12-0104F-K	3.0KW, 240V, 10"
12-0119-K	12-0119F-K	5.0KW, 240V, 10"	12-0105-K	12-0105F-K	2.5KW, 240V, 10"
12-0101-K	12-0101F-K	4.5KW, 240V, 10"	12-0106-K	12-0106F-K	2.0KW, 240V, 10"
12-0102-K	12-0102F-K	4.0KW, 240V, 10"	12-0107-K	N/A	1.3KW, 240V, 10"

7" Flo-Thru Side

N/A	12-0110G-K	5.5KW, 240V, 7"	N/A	12-0114F-K	3.0KW, 240V, 7"
N/A	12-0111F-K	4.5KW, 240V, 7"	N/A	12-0116F-K	2.0KW, 240V, 7"
N/A	12-0112F-K	4.0KW, 240V, 7"	N/A	12-0118F-K	1.5KW, 240V, 7"
N/A	12-0113G-K	3.6KW, 240V, 7"			

9" Flo-Thru Center

12-0509-K	12-0509F-K	5.0KW, 240V, 9"	12-0504-K	12-0504F-K	3.0KW, 240V, 9"
12-0500-K	12-0500F-K	5.5KW, 240V, 9"	12-0505-K	12-0505F-K	2.5KW, 240V, 9"
12-0501-K	12-0501F-K	4.5KW, 240V, 9"	12-0506-K	12-0506F-K	2.0KW, 240V, 9"
12-0502-K	12-0502F-K	4.0KW, 240V, 9"	12-0507-K	12-0507F-K	1.5KW, 240V, 9"
12-0503-K	12-0503F-K	3.5KW, 240V, 9"	12-0508-K	12-0508F-K	1.0KW, 240V, 9"

New Epoxycast® Elements Available

Epoxycast Elements are available in both Incoloy and Titanium by simply adding an "E" to the element part number above.

Example: **12-E0100-K**

HQ HEATER ELEMENT DETAILS

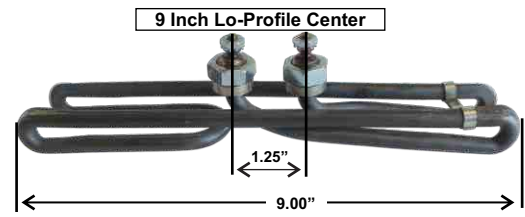
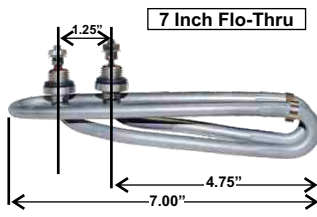
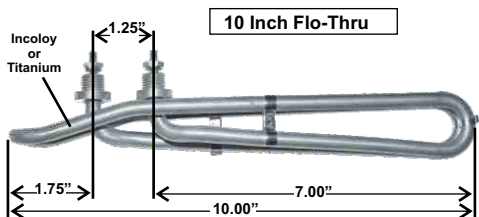

For Flo-Thru:
 Individual Box Dimensions: 10.75"W x 2.25"H x 1.75"D
 Individual Box Weight: .75 lbs.
 24 Master Pack Dimensions: 26"W x 20"H x 11"D
 24 Master Pack Weight: 18.75 lbs.

Conversion Formula = Divide Watts by 4 (IE: 5.5kw x 1000 = 5500watts/4 = 1375watts @ 120V)

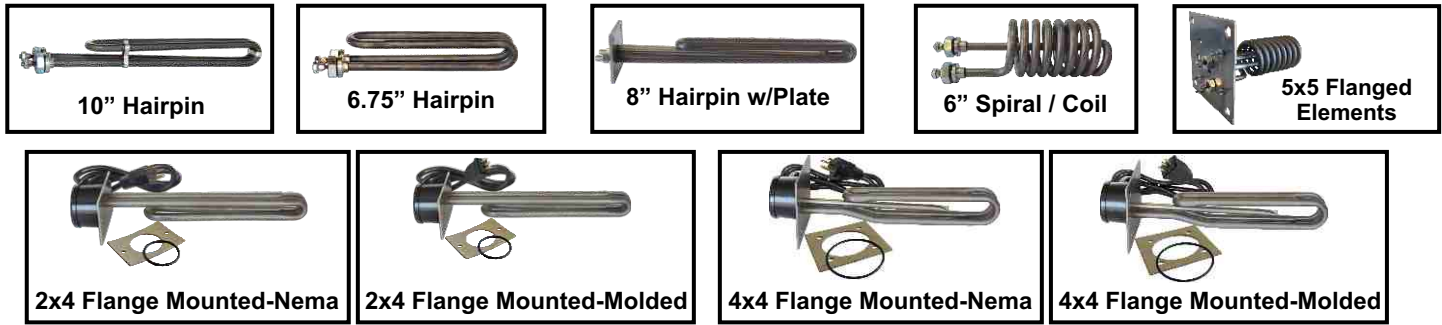

10" Hairpin

INCOLOY PT#	TITANIUM PT#	DESCRIPTION	INCOLOY PT#	TITANIUM PT#	DESCRIPTION
12-0300-K	N/A	5.5KW, 240V, 10"	12-0302-K	N/A	4.0KW, 240V, 10"

6.75" Hairpin

12-0300A-K	N/A	5.5KW, 240V, 6.75"	12-0303A-K	N/A	3.6KW, 240V, 6.75"
12-0302A-K	N/A	4.0KW, 240V, 6.75"	12-0306A-K	N/A	2.0KW, 240V, 6.75"

8" Hairpin w/Plate

N/A	12-0307F-K	2.0KW, 240V, 8"	N/A	12-0309F-K	3.0KW, 240V, 8"
N/A	12-0308F-K	2.5KW, 240V, 8"			

6" Spiral / Coil

N/A	12-0601F-K	4.5KW, 240V, 6"	N/A	12-0606F-K	2.0KW, 240V, 6"
-----	------------	-----------------	-----	------------	-----------------

5" x 5" Flanged Mounted

N/A	12-0010F-K	5.5KW, 240V	N/A	12-0014F-K	3.0KW, 240V
N/A	12-0011F-K	4.5KW, 240V	N/A	12-0016F-K	2.0KW, 240V
N/A	12-0012F-K	4.0KW, 240V			

4" X 4" Flanged Mounted W/Cord

12-1464-BC-K	N/A	1.5KW, 120V, 4" x 4" Plate, w/ Molded 30" Cord
12-1464-AC-K	N/A	1.5KW, 120V, 4" x 4" Plate, w/ Nema 36" Cord

2" X 4" Flanged Mounted W/Cord

12-1463-BC-K	N/A	2.5KW, 240V, 2" x 4" Plate, w/ Molded 30" Cord
12-1463-AC-K	N/A	2.5KW, 240V, 2" x 4" Plate, w/ Nema 36" Cord

HQ HEATER ELEMENT DETAILS

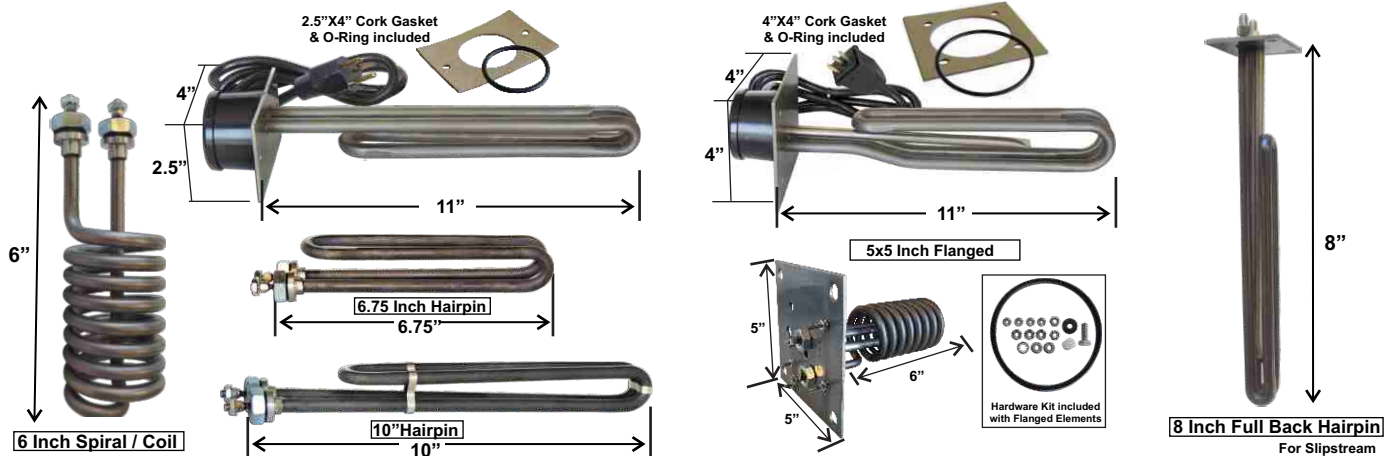

Conversion Formula = Divide Watts by 4 (IE: 5.5kw x 1000 = 5500watts/4 = 1375watts @ 120V)

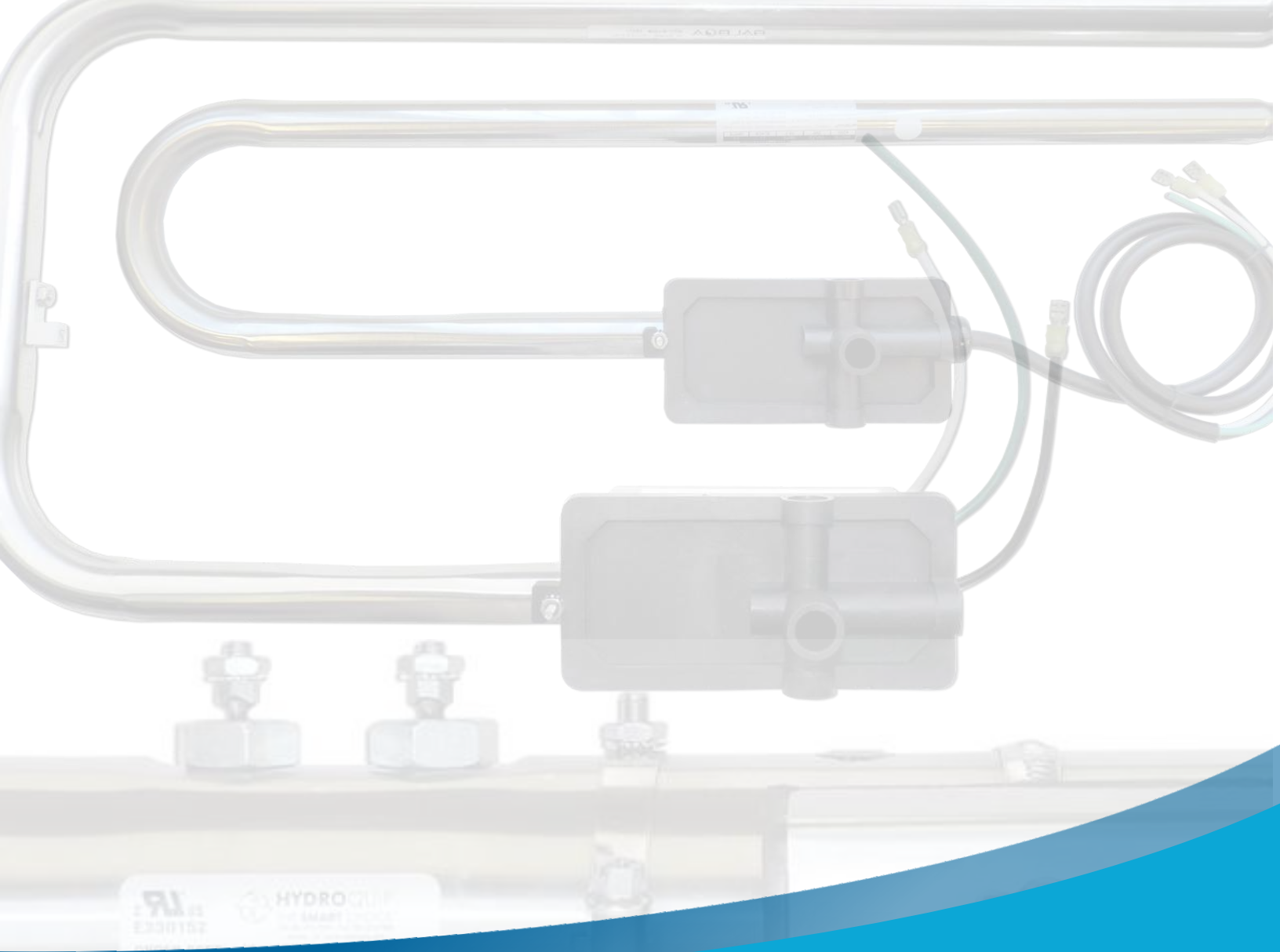

Heater Assembly Cross Reference

Heater Cross Reference Guide

Item #	Universal Replacement	HQ Replacement
01563-31	N/A	26-C3548-1-7T-K
01563-34E-A NHC	N/A	26-3478-1A-BT-K
01781-27	N/A	26-C3548-1-7T-F
12077	27-J0413-5S-K	26-0315-5S-K
1076701	N/A	26-3472-2A-DT-K
2-00-0013	27-J0425-7S-K	26-0056-K
20-00050-C	27-G0500-2S-K	N/A
2-00-0066	N/A	26-301-U-KS
2-00-0089	N/A	26-3478-1A-BT-K
20-00224	27-J0425-7S-K	26-0002-7S-K
20-00227	27-J0425-7S-K	26-0056-7S-K
20-00228	27-J0413-7S-K	N/A
20-00232	27-J0413-7S-K	N/A
20-00242	27-J0568-5S-K	26-0800-5S-K
20-00249	27-J0568-7S-K	26-0601-7S-K
20-00250	27-J0568-7S-K	26-0601-7S-K
20-00251	27-J0568-7S-K	26-0601-7S-K
20-00252	27-J0568-7S-K	N/A
20-00270	27-J0568-7S-K	26-0601-7S-K
20-00271	27-J0568-5S-K	26-0601-5S-K
20-00272	27-J0568-7S-K	26-0800-7S-K
20-00274	27-J0568-7S-K	26-0800-7S-K
20-00277-C	27-J0519-7S-K	N/A
20-00280	27-J0568-5S-K	26-0601-5S-K
20-00281	27-J0568-5S-K	26-0601-5S-K
20-00282	27-J0568-4S-K	N/A
20-00284	27-J0568-5S-K	26-0800-5S-K
20-00285	27-J0568-5S-K	26-0800-5S-K
20-00287C	27-J0519-3S-K	26-0309-3S-K
20-00292	27-J0568-5S-K	26-0601-5S-K
20-00294	27-J0568-5S-K	26-0601-5S-K
20-00296	27-J0568-5S-K	26-0601-5S-K
20-00307	27-J0413-7S-K	N/A
20-00314	27-J0425-4S-K	N/A
20-00316	27-J0425-7S-K	N/A
20-00317	N/A	26-0314-5S-K
20-00318	27-J0425-5S-K	N/A
20-00319	27-J0425-7S-K	N/A
20-00324	27-J0425-6S-K	N/A
20-00328	27-J0425-7S-K	N/A
20-00329	27-J0425-7S-K	N/A
20-00335	27-J0425-7S-K	N/A
20-00336	27-J0425-7S-K	N/A
20-00342	27-J0425-2S-K	N/A
20-00348	27-J0450-7S-K	26-0313N-7S-K
20-00348-C	27-J0450-7S-K	26-0313N-7S-K
20-00354	27-J0425-5S-K	26-0456-5S-K
20-00358	27-G0500-3S-K	N/A
20-00359	27-G0500-6S-K	N/A
20-00403	27-G0443-7S-K	N/A
20-00406	27-M0450-7S-K	26-0213N-7S-K
20-00406C	27-M0450-7S-K	26-0213N-7S-K
20-00407	27-M0438-7S-K	N/A
20-00410	27-J0568-5S-K	26-0601-5S-K
20-00414	27-G0437-5S-K	N/A

Item #	Universal Replacement	HQ Replacement
20-00417	27-J0425-7S-K	N/A
20-00424	27-J0425-7S-K	26-0002-7S-K
20-00425	27-J0425-7S-K	N/A
20-00426	27-D0425-1S-K	N/A
20-00430	27-J0425-7S-K	26-0314-7S-K
20-00433	27-J0425-5S-K	26-0314-5S-K
20-00434	27-J0425-5S-K	26-0314-5S-K
20-00454	27-J0425-5S-K	26-0314-5S-K
20-00467	27-L0700-7S-K	26-1008-7S-K
20-00479	27-G0575-5S-K	N/A
20-00503	27-J0413-7S-K	N/A
20-00514	27-V310-5T-K	N/A
20-00517	27-J0438-7S-K	26-0517-MP-K
20-00518	27-J0438-1S-K	N/A
20-00530	27-J0413-7S-K	26-0736-7S-K
20-00540	27-V310-5T-K	N/A
20-00542	27-V310-4T-K	N/A
20-00574	27-J0425-7S-K	N/A
20-0320ET+	27-V310-5T-K	N/A
2-00-5003	27-J0425-5S-K	26-0314-5S-K
20-08364	N/A	26-0316-MP-KB
20-08421	N/A	BCS-55-3W
20-08421-A	27-G0413-7S-K	N/A
20-08440	N/A	26-0000ABX-7S-K
20-08443	N/A	BCS-55-3W (15")
20-08450	N/A	26-0000ABX-7S-K
20-08520	27-F0CTR-5S-K	N/A
20-08571	27-J0CTR-5S-K	N/A
20-08574	27-J0413-7S-K	N/A
20-08575	27-J0425-7S-K	26-0814-7S-K
20138-001	27-J0CTR-7S-K	26-0316-MP-KB
20-5011	N/A	26-0314-5S-K
22-00254	N/A	48-9123-7T-K
22-00255	N/A	48-9123-7T-K
22-00256	N/A	48-9123-7T-K
22-3R0-00A-1B03	27-F0CTR-7S-K	26-3R0-00A-1B03
22-5011	N/A	26-0314-5S-K
22-653-SY0-1FD0	N/A	26-653-SY0-1FD0
22-65B-000-1PP3	N/A	26-65B-000-1PP3
22-65B-080-1PM3	N/A	26-65B-080-1PM3
22-65B-S00-1F03	N/A	26-65B-S00-1F03
22-65B-S00-1FP3	N/A	26-65B-S00-1FP3
22-65B-S80-1FM3	N/A	26-65B-S80-1FM3
22-65M-000-1PP3	N/A	26-65M-000-1PP3
22-65M-S00-1F03	N/A	26-65M-S00-1F03
22-663-SY0-1FD0	N/A	26-663-SY0-1FD0
22-66B-000-1PP3	N/A	26-66B-000-1PP3
22-66B-080-1PM3	N/A	26-66B-080-1PM3
22-66B-S00-1FP3	N/A	26-66B-S00-1FP3
22-66B-S80-1FM3	N/A	26-66B-S80-1FM3
22-673-SY0-1FD0	N/A	26-673-SY0-1FD0
22-67B-000-1PP3	N/A	26-67B-000-1PP3
22-67B-080-1PM3	N/A	26-67B-080-1PM3
22-67B-S00-1FP3	N/A	26-67B-S00-1FP3
22-67B-S80-1FM3	N/A	26-67B-S80-1FM3

Heater Cross Reference Guide

Item #	Universal Replacement	HQ Replacement
22-67M-000-1PP3	N/A	26-67M-000-1PP3
22-67M-S00-1F03	N/A	26-67M-S00-1F03
22-6PM-S00-1F03	N/A	26-6PM-S00-1F03
22-6R3-SY0-1FD0	N/A	26-6R3-SY0-1FD0
22-6R3-SY0-1FP0	N/A	26-6R3-SY0-1FP0
22-6RM-S00-1F03	N/A	26-6RM-S00-1F03
22-7K8-000-0P06	27-V310-2T-K	N/A
22-7K8-000-0PP6	27-V310-2T-K	N/A
22-7P8-000-0P06	27-V310-2T-K	N/A
22-7P8-000-0PP6	27-V310-5T-K	N/A
22-7R8-000-0P06	27-V310-5T-K	N/A
22-7R8-000-0PP6	27-V310-7T-K	N/A
22-830-000-1E00	27-J0CTR-3S-K	26-830-000-1E00
22-84B-000-1PP3	27-J0CTR-4S-K	26-84B-000-1PP3
22-84B-S00-1FP3	27-J0CTR-4S-K	26-84B-S00-1FP3
22-850-000-1E00	27-J0CTR-5S-K	26-850-000-1E00
22-859-SY0-1FD0	27-J0CTR-5S-K	26-859-SY0-1FD0
22-85B-000-1PP3	27-J0CTR-5S-K	26-85B-000-1PP3
22-85B-080-1PM3	27-J0CTR-5S-K	26-85B-080-1PM3
22-85B-B00-1FP3	27-J0CTR-5S-K	26-85B-B00-1FP3
22-85B-S00-1F63	27-J0CTR-5S-K	26-85B-S00-1F63
22-85B-S00-1FP3	27-J0CTR-5S-K	26-85B-S00-1FP3
22-85B-S80-1FM3	27-J0CTR-5S-K	26-85B-S80-1FM3
22-85B-SY0-1FD0	27-J0CTR-5S-K	26-85B-SY0-1FD0
22-85M-S00-1F03	27-J0CTR-5S-K	26-85M-S00-1F03
22-869-SY0-1FD0	27-J0CTR-6S-K	26-869-SY0-1FD0
22-86B-000-1PP3	27-J0CTR-6S-K	26-86B-000-1PP3
22-86B-080-1PM3	27-J0CTR-6S-K	26-86B-080-1PM3
22-86B-S00-1F63	27-J0CTR-6S-K	26-86B-S00-1F63
22-86B-S00-1FP3	27-J0CTR-6S-K	26-86B-S00-1FP3
22-86B-S80-1FM3	27-J0CTR-6S-K	26-86B-S80-1FM3
22-86B-SY0-1FD0	27-J0CTR-6S-K	26-86B-SY0-1FD0
22-86M-000-1P03	27-J0CTR-6S-K	26-86M-000-1P03
22-86M-S00-1F03	27-J0CTR-6S-K	26-86M-S00-1F03
22-870-000-1E00	N/A	48-0146-K
22-873-000-0003	27-J0CTR-7S-K	26-873-000-0003
22-873-000-0DD3	27-J0CTR-7S-K	26-873-000-0DD3
22-873-040-0DD3	27-J0CTR-7S-K	26-873-040-0DD3
22-873-050-0DD3	27-J0CTR-7S-K	26-873-050-0DD3
22-873-050-0G03	27-J0CTR-7S-K	26-873-050-0G03
22-873-050-MA40	27-J0CTR-7S-K	26-873-050-MA40
22-873-SY0-1FP3	27-J0CTR-7S-K	26-873-SY0-1FP3
22-873-YY0-1HD0	27-J0CTR-7S-K	26-873-YY0-1HD0
22-879-SY0-1FD0	27-J0CTR-7S-K	26-879-SY0-1FD0
22-87B-000-1PP3	27-J0CTR-7S-K	26-87B-000-1PP3
22-87B-080-1PM3	27-J0CTR-7S-K	26-87B-080-1PM3
22-87B-B00-1FP3	27-J0CTR-7S-K	26-87B-B00-1FP3
22-87B-S00-1F63	27-J0CTR-7S-K	26-87B-S00-1F63
22-87B-S00-1FP3	27-J0CTR-7S-K	26-87B-S00-1FP3
22-87B-S80-1FM0	27-J0CTR-7S-K	26-87B-S80-1FM0
22-87B-S80-1FM3	27-J0CTR-7S-K	26-87B-S80-1FM3
22-87B-S80-1PM3	27-J0CTR-7S-K	26-87B-S80-1PM3
22-87B-S90-1FP3	27-J0CTR-7S-K	26-87B-S90-1FP3
22-87B-SY0-1FD0	27-J0CTR-7S-K	26-87B-SY0-1FD0
22-87M-000-1P03	27-J0CTR-7S-K	26-87M-000-1P03

Item #	Universal Replacement	HQ Replacement
22-87M-S00-1F03	27-J0CTR-7S-K	26-87M-S00-1F03
22-8P9-SY0-1FD0	27-J0CTR-5S-K	26-8P9-SY0-1FD0
22-8PB-S00-1FP3	27-J0CTR-5S-K	26-8PB-S00-1FP3
22-8PM-S00-1F03	27-J0CTR-5S-K	26-8PM-S00-1F03
22-8Q9-SY0-1FD0	27-J0CTR-6S-K	26-8Q9-SY0-1FD0
22-8QM-000-1P03	27-J0CTR-6S-K	26-8QM-000-1P03
22-8QM-S00-1F03	27-J0CTR-6S-K	26-8QM-S00-1F03
22-8R9-SY0-1FD0	27-J0CTR-7S-K	26-8R9-SY0-1FD0
22-8RB-S80-1FM3	27-J0CTR-7S-K	26-8RB-S80-1FM3
22-8RM-S00-1F03	27-J0CTR-7S-K	26-8RM-S00-1F03
22-C23-050-0G03	27-G0CTR-2S-K	26-C23-050-0G03
22-C63-050-0G00	27-G0CTR-7S-K	26-C63-050-0G00
22-C73-000-0003	27-G0CTR-7S-K	26-C73-000-0003
22-C73-000-0DD3	27-G0CTR-7S-K	26-C73-000-0DD3
22-C73-040-0DD3	27-G0CTR-7S-K	26-C73-040-0DD3
22-C73-040-0G03	27-G0CTR-7S-K	26-C73-040-0G03
22-C73-050-0G03	27-G0CTR-7S-K	26-C73-050-0G03
22-C73-060-0G08	27-G0CTR-7S-K	26-C73-060-0G08
22-C7B-000-0PP3	27-G0CTR-7S-K	26-C7B-000-0PP3
22-CK3-050-0G00	27-G0CTR-3S-K	26-CK3-050-0G00
22-CQ3-050-0G00	27-G0CTR-6S-K	26-CQ3-050-0G00
22-CQ3-YY0-1HD0	27-G0CTR-6S-K	26-CQ3-YY0-1HD0
22-E4C-000-0L00	27-G0CTR-4S-K	26-E4C-000-0L00
22-K5B-S50-1FP0	N/A	26-K5B-S50-1FP0
22-K6B-S50-1FP0	N/A	26-K6B-S50-1FP0
22-K7B-050-1PP0	N/A	26-K7B-050-1PP0
22-K7B-080-1PM3	N/A	26-K7B-080-1PM3
22-K7B-S50-1FP0	N/A	26-K7B-S50-1FP0
22-K7B-S80-1FM0	N/A	26-K7B-S80-1FM0
22-L73-050-0F02	27-J0CTR-7S-K	26-L73-050-0F02
22-M73-050-0540	N/A	26-M73-050-0540
22-MK8-000-0P06	N/A	26-MK8-000-0P06
22-MK8-000-0PP6	N/A	26-MK8-000-0PP6
22-MP0-00A-0F00	N/A	26-MP0-00A-0F00
22-MR8-000-0P06	N/A	26-MR8-000-0P06
22-MR8-000-0PP6	N/A	26-MR8-000-0PP6
26-0000ABX-7S-K	N/A	26-0000ABX-7S-K
26-0001-5S-K	27-F0425-5S-K	N/A
26-0002-5S-K	27-J0425-5S-K	N/A
26-0002-7S-K	27-J0425-7S-K	N/A
26-0003A	27-J0519-7S-K	N/A
26-00100	27-V310-7T-K	N/A
26-00104	27-V310-7T-K	N/A
26-0010-4S-K	27-J0413-4S-K	N/A
26-00105	27-V310-7T-K	N/A
26-0010-6S-K	27-J0413-6S-K	N/A
26-00107	27-V310-7T-K	N/A
26-0010-7S-K	27-J0413-7S-K	N/A
26-00110	27-V310-5T-K	N/A
26-0011-3S-K	N/A	26-0011-3S-K
26-00115	27-V310-5T-K	N/A
26-0011-5S-K	N/A	26-0011-5S-K
26-00116	27-V310-7T-K	N/A
26-0011-7S-K	N/A	26-0011-7S-K
26-0011-F-PS-K	N/A	26-0011-F-PS-K

Heater Cross Reference Guide

Item #	Universal Replacement	HQ Replacement
26-00120	27-V310-7T-K	N/A
26-00141	27-V310-7T-K	N/A
26-00145	27-V310-5T-K	N/A
26-00147	27-V310-7T-K	N/A
26-00155	27-V310-5T-K	N/A
26-00157	27-V310-5T-K	N/A
26-0017A	N/A	26-0082A-K
26-00225	27-V310-3T-K	N/A
26-0024-4S-K	27-J0413-4S-K	N/A
26-00254	27-V310-5T-K	N/A
26-00255	27-V310-7T-K	N/A
26-00257	27-V310-5T-K	N/A
26-0028-4S-K	27-J0413-4S-K	N/A
26-0028-5S-K	27-J0413-5S-K	N/A
26-0031	N/A	26-0082-K
26-0032	27-J0519-7S-K	26-0071-K
26-0032A	27-J0519-7S-K	26-0071-K
26-0032-R1	27-J0519-7S-K	48-260032-R1
26-0032-R1C	27-J0519-7S-K	26-0071-K
26-0034-R1	27-J0519-6S-K	48-260034-R1
26-0035-7S-K	27-J0425-7S-K	26-0035-7S-K
26-0036-R1C	27-J0519-5S-K	26-0071B-K
26-0047-K	27-J0519-6S-K	26-0047-K
26-0047-R1	27-J0519-6S-K	26-0047-K
26-0053-F-M7-KS	27-M0694-7T-K	26-0053-F-M7-KS
26-0053-K	27-M0694-7S-K	26-0053-K
26-0054AF-M7-KS	N/A	26-0054AF-M7-KS
26-0054A-K	N/A	26-0054A-K
26-0054-K	N/A	26-0054-K
26-0056-2S-K	27-J0425-2S-K	N/A
26-0056-4S-K	27-J0425-4S-K	N/A
26-0056-5S-K	27-J0425-5S-K	N/A
26-0056-7S-K	27-J0425-7S-K	N/A
26-0058	27-J0519-7S-K	26-0071-K
26-0063-XD-K	N/A	26-0063-XD-K
26-0063-XD-KS	N/A	26-0063-XD-KS
26-0066A-KIT-FS	N/A	26-0066A-KIT-FS
26-0066A-KIT-PS	N/A	26-0066A-KIT-PS
26-0069-7S-KS	27-G0357-7S-K	26-0069-7S-KS
26-0070B-1-K	27-G0413-5S-K	26-0070B-1-K
26-0070C-K	27-G0413-2S-K	26-0070C-K
26-0070-K	27-G0413-7S-K	26-0070-K
26-0071	27-J0519-7S-K	26-0071-K
26-0071-7KSS	27-J0519-7S-K	N/A
26-0071-7KSS-K	27-J0519-7S-K	26-0071-7KSS-K
26-0071A-K	27-J0519-6S-K	26-0071A-K
26-0071B	27-J0519-5S-K	26-0071B-K
26-0071-BAP-K	27-J0519-7S-K	N/A
26-0071B-K	27-J0519-5S-K	N/A
26-0071-FA-K	27-J0519-7S-K	N/A
26-0071-F-FA-K	27-J0519-7T-K	N/A
26-0071-K	27-J0519-7S-K	N/A
26-0071-M7-FA-K	27-J0413-7S-K	N/A
26-0071-M7-KS	27-J0425-7S-K	26-0071-M7-KS
26-0072-15-K	27-J0519-7S-K	26-0072-15-K

Item #	Universal Replacement	HQ Replacement
26-0072A-15-K	27-J0519-6S-K	26-0072A-15-K
26-0072A-K	27-G0413-6S-K	26-0072A-K
26-0072B-15-K	27-J0519-5S-K	26-0072B-15-K
26-0079-K	27-J0519-7S-K	26-0079-K
26-0082A-F-K	N/A	26-0082A-F-K
26-0082A-K	N/A	26-0082A-K
26-0082-K	N/A	26-0082-K
26-0104-Z-5KB	27-F0315-5S-K	26-0104-Z-5KB
26-0155-7S-K	27-L0550-7S-K	26-0155-7S-K
26-0165-5S-K	27-K0550-5S-K	26-0165-5S-K
26-0165-7S-K	27-K0550-7S-K	26-0165-7S-K
26-0213N-7S-K	27-M0450-7S-K	26-0213N-7S-K
26-0309-3S-K	27-J0519-3S-K	N/A
26-0309-4S-K	27-J0519-4S-K	N/A
26-0313N-7S-K	27-J0450-7S-K	N/A
26-0314-5S-K	27-J0425-5S-K	N/A
26-0314-7S-K	27-J0425-7S-K	N/A
26-0316-MP-KB	N/A	26-0316-MP-KB
26-0456-5S-K	27-J0425-5S-K	N/A
26-0517-4P-K	27-J0438-4S-K	N/A
26-0517-MP-K	27-J0438-7S-K	N/A
26-0520-7T-K	27-G0350-7S-K	26-0520-7T-K
26-0535-5S-K	27-J0425-5S-K	N/A
26-0535-5S-KP	27-J0425-5S-K	N/A
26-0535-5S-KP01	27-J0425-5S-K	N/A
26-0535-7S-K	27-J0425-7S-K	N/A
26-0535-7S-KP	27-J0425-7S-K	N/A
26-0535-7S-KP01	27-J0425-7S-K	N/A
26-0556-7S-K	27-J0425-7S-K	N/A
26-0601-2S-K	27-J0568-2S-K	N/A
26-0601-3S-K	27-J0568-3S-K	N/A
26-0601-5S-K	27-J0568-5S-K	N/A
26-0601-7S-K	27-J0568-7S-K	N/A
26-0601-AS-K	27-J0568-AT-K	N/A
26-0601-KT-K	27-J0568-AT-K	N/A
26-0736-3S-K	27-J0425-3S-K	N/A
26-0736-7S-K	27-J0425-7S-K	N/A
26-0739-5SD-K	27-J0413-5S-K	N/A
26-0739-7SD-K	27-J0413-7S-K	N/A
26-0800-2S-K	27-J0568-2S-K	N/A
26-0800-3S-K	27-J0568-3S-K	N/A
26-0800-4S-K	27-J0568-4S-K	N/A
26-0800-5S-K	27-J0568-5S-K	N/A
26-0800-5T-K	27-J0568-4S-K	N/A
26-0800-7S-K	27-J0568-7S-K	N/A
26-0800-AS-K	27-J0568-AT-K	N/A
26-0802-5S-K	27-J0568-5S-K	N/A
26-0802-6S-K	27-J0568-6S-K	N/A
26-0802-7S-K	27-J0568-7S-K	N/A
26-0802A-2S-K	27-J0568-2S-K	N/A
26-0802A-3S-K	27-J0568-3S-K	N/A
26-0802A-5S-K	27-J0568-5S-K	N/A
26-0807-4S-K	27-J0425-4S-K	26-58118-K
26-0807-4S-KS	27-J0425-4S-K	26-58118-K
26-0807-5S-K	27-J0425-5S-K	26-58104-K

Heater Cross Reference Guide

Item #	Universal Replacement	HQ Replacement
26-0807-5S-KS	27-J0425-5S-K	26-58104-K
26-0807-7S-K	27-J0425-7S-K	26-58083-K
26-0807-7S-KS	27-J0425-7S-K	26-58083-K
26-0808-7TD-K	27-J0425-7S-K	26-0808-7TD-K
26-0809-5S-K	27-J0425-5S-K	26-58048-K
26-0809-5S-KSP	27-J0425-5S-K	26-58048-K
26-0809-7S-K	27-J0425-7S-K	26-58019-K
26-0809-7S-KSP	27-J0425-7S-K	26-58019-K
26-08102	27-V310-5T-K	N/A
26-08103	27-V310-7T-K	N/A
26-08104	27-V310-7T-K	N/A
26-08106	27-V310-7T-K	N/A
26-08107	27-V310-7T-K	N/A
26-08108	27-V310-5T-K	N/A
26-08109	27-V310-5T-K	N/A
26-08112	27-V310-7T-K	N/A
26-08114	27-V310-5T-K	N/A
26-08115	27-V310-5T-K	N/A
26-08116	27-V310-4T-K	N/A
26-08118	27-V310-5T-K	N/A
26-08119	27-V310-5T-K	N/A
26-08120	27-V310-7T-K	N/A
26-081214	27-V310-5T-K	N/A
26-08125	27-V310-7T-K	N/A
26-08145	27-V310-5T-K	N/A
26-08146	27-V310-5T-K	N/A
26-08147	27-V310-7T-K	N/A
26-0814-7S-K	27-J0425-7S-K	26-0814-7S-K
26-08153	27-V310-7T-K	N/A
26-08155	27-V310-7T-K	N/A
26-08156	27-V310-7T-K	N/A
26-08157	27-V310-5T-K	N/A
26-08159	27-V310-5T-K	N/A
26-08174	27-V310-5T-K	N/A
26-08175	27-V310-7T-K	N/A
26-08235	27-V310-5T-K	N/A
26-08245	27-V310-5T-K	N/A
26-1001-3S-K	N/A	26-1001-3S-K
26-1001-5S-K	N/A	26-1001-5S-K
26-1002-3S-K	27-F0288-3S-K	26-1002-3S-K
26-1002-4S-K	27-F0288-4S-K	26-1002-4S-K
26-1002-5S-K	27-F0288-5S-K	26-1002-5S-K
26-1002-5T-K	27-F0288-5S-K	26-1002-5T-K
26-1002-7S-K	27-F0288-7S-K	26-1002-7S-K
26-1002-7T-K	27-F0288-7S-K	26-1002-7T-K
26-1002-AS-K	27-F0288-AT-K	26-1002-AS-K
26-1004-5S-K	27-F0313-5S-K	26-1004-5S-K
26-1004-6S-K	27-F0313-6S-K	26-1004-6S-K
26-1004-7S-K	27-F0288-7S-K	26-1004-7S-K
26-1004-7T-K	27-F0288-7S-K	26-1004-7T-K
26-1008-4S-K	27-L0700-4S-K	26-1008-4S-K
26-1008-6S-K	27-L0700-6S-K	26-1008-6S-K
26-1008-7S-K	27-L0700-7S-K	26-1008-7S-K
26-1206-4S-K	27-G0413-4S-K	26-1206-4S-K
26-1206-5S-K	27-G0413-5S-K	26-1206-5S-K

Item #	Universal Replacement	HQ Replacement
26-1206-7S-K	27-G0413-7S-K	26-1206-7S-K
26-1227-5S-K	27-J0519-5S-K	26-1227-5S-K
26-1227-7S-K	27-J0519-7S-K	26-1227-7S-K
26-1540F-RP-TSD	27-J0413-5S-K	N/A
26-1540-RP-TSD	27-J0413-5S-K	N/A
26-1545F-RP-TSD	27-J0413-6S-K	N/A
26-1545-RP-TSD	27-J0413-6S-K	N/A
26-1555F-RP-TSD	27-J0413-7S-K	N/A
26-1555-RP-TSD	27-J0413-7S-K	N/A
26-2001-3S-K	27-J0519-3S-K	26-2001-3S-K
26-2001-5S-K	27-J0519-5S-K	26-2001-5S-K
26-2001-7S-K	27-J0519-7S-K	26-2001-7S-K
26-2300-2S-K	27-F0575-2S-K	26-2300-2S-K
26-2300-4S-K	27-F0575-4S-K	26-2300-4S-K
26-2300-5S-K	27-F0575-5S-K	26-2300-5S-K
26-3314-1-7T-K	N/A	26-310-U-K
26-3330-5S-K	27-J0568-5S-K	N/A
26-3403-1-BT-K	N/A	26-315-U-K
26-3411-1-7T-K	N/A	26-310-U-K
26-3478-1A-BT-K	N/A	26-3478-1A-BT-K
26-350-000-1B03	27-F0CTR-5S-K	26-350-000-1B03
26-3R0-00A-1B03	27-F0CTR-7S-K	26-3R0-00A-1B03
26-50080-K	27-J0425-7S-K	N/A
26-50081-K	27-J0425-5S-K	N/A
26-50096-K	27-J0425-7S-K	26-0535-7S-KP
26-58019-K	27-J0425-7S-K	N/A
26-58027-K	27-J0425-7S-K	N/A
26-58029-K	27-J0425-5S-K	N/A
26-58048-K	27-J0425-5S-K	N/A
26-58081-K	27-J0425-5S-K	N/A
26-58083-K	27-J0425-7S-K	N/A
26-58104-K	27-J0425-5S-K	N/A
26-58118-K	27-J0425-4S-K	N/A
26-58138-K	27-J0425-1S-K	N/A
26-58145-K	27-J0425-2S-K	N/A
26-58198-K	N/A	26-58198-K
26-67B-000-1PP3	N/A	26-67B-000-1PP3
26-67B-S00-1FP3	N/A	26-67B-S00-1FP3
26-67B-S80-1FM3	N/A	26-67B-S80-1FM3
26-85B-S00-1FP3	27-J0CTR-5S-K	26-85B-S00-1FP3
26-85M-S00-1F03	27-J0CTR-5S-K	26-85M-S00-1F03
26-860-000-1B03	27-J0CTR-6S-K	26-860-000-1B03
26-86B-S00-1FP3	27-J0CTR-6S-K	26-86B-S00-1FP3
26-86B-S80-1FM3	27-J0CTR-6S-K	26-86B-S80-1FM3
26-870-000-1B03	27-J0CTR-7S-K	26-870-000-1B03
26-87B-000-1PP3	27-J0CTR-7S-K	26-87B-000-1PP3
26-87B-080-1PM3	27-J0CTR-7S-K	26-87B-080-1PM3
26-87B-B00-1FP3	27-J0CTR-7S-K	26-87B-B00-1FP3
26-87B-S00-1FP3	27-J0CTR-7S-K	26-87B-S00-1FP3
26-87B-S80-1FM3	27-J0CTR-7S-K	26-87B-S80-1FM3
26-87M-S00-1F03	27-J0CTR-7S-K	26-87M-S00-1F03
26-C2278-1-5S-K	27-F0475-5S-K	26-C2278-1-5S-K
26-C3480-1-7T-K	N/A	26-C3480-1-7T-K
26-C3548-1-7T-F	N/A	26-C3548-1-7T-F
26-C3550-1-7T	N/A	26-C3550-1-7T

Heater Cross Reference Guide

Item #	Universal Replacement	HQ Replacement
26-C3550-1-7T-K	N/A	26-C3550-1-7T-K
26-C3552-1-7T	N/A	26-C3552-1-7T
26-C3552-1-7T-K	N/A	26-C3552-1-7T-K
26-H0021-7S-K	27-J0463-7S-K	26-H0021-7S-K
26-H0136-6S-K	27-J0519-6S-K	N/A
26-H3117-CT-K	N/A	26-H3117-CT-K
26-MP0-00A-0F00	N/A	26-MP0-00A-0F00
28-E0300-4T-K	27-V310-4T-K	N/A
28-E0410-0T-K	27-V310-0T-K	N/A
307878	N/A	26-310-U-K
3314-1	N/A	26-310-U-K
411092	27-L0700-6S-K	26-1008-6S-K
46-138-1305	27-J0425-7S-K	26-58083-K
46-138-1320	27-J0425-5T-K	26-55625-K
46-138-1340	27-J0425-5S-K	26-58104-K
46-138-1345	27-J0425-7S-K	26-58083-K
46-138-1350	N/A	26-58203-K
46-138-1370	27-J0425-5S-K	26-58081-K
46-238-1700	27-F0575-5S-K	26-2300-5S-K
46-320-1165	27-J0425-5S-K	N/A
46-320-1165	N/A	26-0314-5S-K
46-355-3025	N/A	26-310-U-K
46-455-1010	N/A	26-310-U-K
46-555-1000	N/A	26-301-U-KS
48-0007A	N/A	48-0007A
48-0007B	N/A	48-0007B
48-0017	N/A	48-0017
48-0017A	N/A	48-0017A
48-0018A	N/A	48-0018A
48-1520F-RP	27-J0413-2T-K	N/A
48-1520-RP	27-J0413-2S-K	N/A
48-1520-RP-GEK	27-J0568-2S-K	N/A
48-1530-RP-GEK	27-J0568-4S-K	N/A
48-1540-RP	27-J0425-5S-K	N/A
48-1540-RP-BWG	27-J0425-5S-K	N/A
48-1540-RP-GEK	27-J0568-5S-K	N/A
48-1540-RP-HQ	27-J0519-5S-K	N/A
48-1545-RP	27-J0413-6S-K	N/A
48-1555F-RP	27-J0413-7S-K	N/A
48-1555-HQ	27-J0519-7S-K	N/A
48-1555-RP	27-J0413-7S-K	N/A
48-1555-RP-BWG	27-J0425-7S-K	N/A
48-1555-RP-GEK	27-J0568-7S-K	N/A
48-260032	27-J0519-7S-K	N/A
48-260032-R1	27-J0519-7S-K	N/A
48-260034-R1	27-J0519-6S-K	N/A
48-260050-13A	27-F0CTR-7S-K	N/A
48-3300-00-00	N/A	26-0000ABX-7S-K
48-3300-10-002H	27-F0313-7S-K	26-1002-7S-K
48-3300-10-003H	27-F0313-7S-K	26-1002-7S-K
48-3300-10-013H	27-M0450-7S-K	26-0213N-7S-K
48-3300-10-321H	27-J0425-7S-K	
48-3300-10-035H	27-J0425-7S-K	26-0035-7S-K
48-3300-10-154H	27-J0425-7S-K	26-0314-7S-K
48-3300-10-435H	27-J0425-5S-K	26-0535-5S-K

Item #	Universal Replacement	HQ Replacement
48-3300-10-736H	27-J0413-7S-K	26-0736-7S-K
48-3300-16	27-J0425-7S-K	26-0002-7S-K
48-3300-40-001	27-V310-7T-K	N/A
48-3300-40-020	27-V310-7T-K	N/A
48-3300-40-101	27-V310-5T-K	N/A
48-330-10-304H	27-J0425-7S-K	26-0314-7S-K
48-3600-10-002H	27-F0313-5S-K	26-1002-5S-K-T
48-3600-40-003	27-V310-5T-K	N/A
48-3600-40-004	27-V310-5T-K	N/A
48-3600-40-012	27-V310-5T-K	N/A
48-3600-40-014	27-V310-5T-K	N/A
48-9120 (R1-R6)	27-F0CTR-7S-K	48-9120-7P-K
48-9120-K	27-F0CTR-7S-K	48-9120-7P-K
48-9121(R1-R4)	N/A	48-9121-7S-K
48-9121-K	N/A	48-9121-7S-K
48-9122-AT-K	N/A	48-9122-AT-K
48-9123(R1-R4)	N/A	48-9123-7T-K
48-9124(R1-R3)	N/A	48-9124-AP-K
48-9125(R1)	27-J0CTR-5S-K	48-9125-5T-K
48-9130(R1-R4)	N/A	48-9130-CP-K
48-9130-CP-K	N/A	48-9130-CP-K
48-9130-K	N/A	48-9130-CP-K
48-9150(R1-R6)	27-F0CTR-5S-K	48-9150-5P-K
48-9150-5P-K	27-F0CTR-5S-K	48-9150-5P-K
48-9150-K	27-F0CTR-5S-K	48-9150-5P-K
48-9150-R2-S	27-F0CTR-5S-K	48-9150-5P-K
48-9150-S	27-F0CTR-5S-K	48-9150-5P-K
48-9151(R1-R2)	27-F0CTR-AT-K	48-9151-AP-K
48-9151-AP-K	27-F0CTR-AT-K	48-9151-AP-K
50067	27-J0425-5S-K	26-0535-5S-KP
50067	27-J0425-5S-K	26-58081-K
50071	27-J0425-7S-K	26-0535-7S-KP
50071	27-J0425-7S-K	26-0535-7S-K
50076	27-J0425-7S-K	26-0535-7S-KP
50076	27-J0425-7S-K	26-0535-7S-K
50080	27-J0425-7S-K	26-0535-7S-K
50080	27-J0425-7S-K	26-50080-K
50081	27-J0425-5S-K	26-0535-5S-K
50081	27-J0425-5S-K	26-50081-K
50096	27-J0425-7S-K	26-0535-7S-KP
50096	27-J0425-7S-K	26-0535-7S-KP
50134	27-J0425-7S-K	26-0535-7S-KP
50134	27-J0425-7S-K	26-0535-7S-K
50142	27-J0425-5S-K	26-0535-5S-KP
50142	27-J0425-5S-K	26-58081-K
50150	27-J0425-7S-K	26-0535-7S-KP
50150	27-J0425-7S-K	26-0535-7S-K
53349	27-J0425-5S-K	26-0809-5S-KSP
53349	27-J0425-5S-K	26-58048-K
55033	27-J0425-5S-K	26-58104-K
55035	27-J0425-5S-K	26-58104-K
55881	27-J0425-2S-K	26-58145-K
58000	27-J0425-7S-K	26-58083-K
58001	N/A	26-58001-K
58002	27-J0425-7S-K	26-58083-K

Heater Cross Reference Guide

Item #	Universal Replacement	HQ Replacement
58004	N/A	26-58001-K
58009	27-J0425-5S-K	26-0535-5S-KP
58009	27-J0425-5S-K	26-58081-K
58010	27-J0425-7S-K	26-58083-K
58013	27-J0425-7S-K	26-0809-7S-KSP
58013	27-J0425-7S-K	26-58019-K
58015	27-J0425-7S-K	26-0535-7S-K
58016	27-J0425-7S-K	26-58083-K
58019	27-J0425-7S-K	26-0809-7S-KSP
58019	27-J0425-7S-K	26-58019-K
58026	27-J0425-7S-K	26-0809-7S-KSP
58026	27-J0425-7S-K	26-58019-K
58027	27-J0425-7S-K	26-0809-7S-K
58027	27-J0425-7S-K	26-58027-K
58028	27-J0425-5S-K	26-0809-5S-KSP
58028	27-J0425-5S-K	26-58048-K
58029	27-J0425-5S-K	26-0809-5S-K
58029	27-J0425-5S-K	26-58029-K
58030	N/A	26-301-U-KS
58031	27-J0425-5S-K	26-58104-K
58032	27-J0425-5S-K	26-58104-K
58042	N/A	26-1001-5S-K
58048	27-J0425-5S-K	26-0809-5S-KSP
58048	27-J0425-5S-K	26-58048-K
58056	27-J0425-5S-K	26-58104-K
58061	27-J0425-4S-K	26-58118-K
58064	27-J0425-5S-K	26-58104-K
58066	27-J0425-7S-K	26-0809-7S-KSP
58066	27-J0425-7S-K	26-58019-K
58067	27-J0425-5S-K	26-0809-5S-KSP
58067	27-J0425-5S-K	26-58048-K
58069	27-J0425-5S-K	26-0535-5S-KP
58069	27-J0425-5S-K	26-58081-K
58074	27-J0425-7S-K	26-0809-7S-KSP
58074	27-J0425-7S-K	26-58019-K
58081	27-J0425-5S-K	26-0535-5S-KP
58081	27-J0425-5S-K	26-58081-K
58083	27-J0425-7S-K	26-58083-K
58085	27-J0425-7S-K	N/A
58086	27-J0425-7S-K	26-58083-K
58089	27-J0425-7S-K	26-58083-K
58103	27-J0425-5S-K	26-58104-K
58104	27-J0425-5S-K	26-58104-K
58105	27-J0425-7S-K	26-58083-K
58106	27-J0425-5S-K	26-58104-K
58109	27-J0425-5S-K	26-58104-K
58117	27-J0425-5S-K	26-58104-K
58118	27-J0425-4S-K	26-58118-K
58120	27-J0425-5S-K	26-58104-K
58121	27-J0425-7S-K	26-58083-K
58123	27-J0425-7S-K	26-58083-K
58138	27-J0425-1T-K	26-58138-K
58145	27-J0425-2S-K	26-58145-K
58148	27-J0425-5S-K	26-58104-K
58151	27-J0425-7S-K	26-55624-K

Item #	Universal Replacement	HQ Replacement
58198	N/A	26-58198-K
58203	N/A	26-58203-K
58206	N/A	26-58203-K
58209	27-J0425-7S-K	26-58083-K
58212	27-J0425-5S-K	26-58104-K
58286	N/A	26-3330-5S-K
58335	N/A	26-315-U-K
58336	N/A	26-310-U-K
58352	N/A	26-85M-000-AR03
58373	N/A	26-3478-1A-BT-K
530AA0078	27-J0568-5S-K	26-0800-5S-K
530AA0095	27-J0568-5S-K	26-0800-5S-K
530AA0107	27-J0568-7S-K	26-0800-7S-K
530AA0284	27-J0568-7S-K	26-0601-7S-K
530AA0293	27-J0568-5S-K	26-0601-5S-K
530AA0437	27-J0568-7S-K	26-0601-7S-K
52009	N/A	26-58001-K
52010	N/A	26-58001-K
52099	N/A	26-58001-K
52108	N/A	26-58001-K
6144	N/A	26-C3548-1-7T-F
6144.3	N/A	26-C3548-1-7T-F
6595.1	N/A	26-3473-1-5T-K
6758	N/A	26-C3160-2S
61443	N/A	26-C3548-1-7T-F
6000-155	27-F0313-5S-K	26-1002-5S-K
6000-156	27-J0425-5S-K	26-0056-7S-K
6500-062	N/A	26-3226-2A-BT-K
6500-063	N/A	26-3226-1A-5T-K
6500-301	N/A	26-301-U-KS
6500-303	N/A	26-303-U-KS
6500-310	N/A	26-310-U-K
6500-315	N/A	26-315-U-K
6500-316	N/A	26-310-U-K
6500-402	N/A	26-3229-2A-7T-K
6500-403	N/A	26-3229-2A-7T-K
6500-407	27-J0413-7S-K	26-0556-7S-K
6500-843	N/A	26-310-U-K
6500-844	N/A	26-315-U-K
6HI/HL	N/A	BIS-60-240
6HI-HL-120	N/A	BIS-15-120
6HI-HL-240	N/A	BIS-60-240
7154	N/A	26-C3236-1A-5T-K
7211	N/A	26-C3160-1S
71580	N/A	26-3330-5S-K
72163	27-J0425-5S-K	26-C2839-5S-K
72494	N/A	26-3473-1-5T-K
72651	27-J0568-5S-K	26-0800-5S-K
72795	N/A	26-C3072-8T-KF
72796	N/A	26-C3073-1T-KF
73009	N/A	26-C3548-1-7T-F
73039	N/A	26-C3160-2S
73790	N/A	26-C3160-1S
73791	N/A	26-C3160-2S
73792	N/A	26-C3182-1S

Heater Cross Reference Guide

Item #	Universal Replacement	HQ Replacement
73994	27-J0568-5S-K	26-3330-5S-K
74912	N/A	26-3473-1-5T-K
76227	N/A	26-C3072-8T-KF
76228	N/A	26-C3072-5T-KF
76229	N/A	26-C3073-1T-KF
6500-401	N/A	26-3478-1A-BT-K
775-5001	27-J0425-7S-K	26-0808-7S-K
90225011	N/A	26-0314-5S-K
9143E	N/A	26-301-U-KS
9920-100338	27-J0568-5S-K	26-0800-5S-K
9920-100339	27-J0568-7S-K	26-0800-7S-K
9920-100340	27-J0568-2S-K	N/A
9920-100342	27-J0568-4S-K	N/A
9920-100345	27-J0568-4S-K	N/A
9920-100346	27-J0568-5S-K	26-0601-5S-K
9920-100347	27-J0568-7S-K	26-0601-7S-K
A2200-5100ET	N/A	48-9124-2S-K
A2200-5250ET	N/A	48-9124-2S-K
A2300-5100ET	N/A	48-9124-4S-K
A2300-5200ET	N/A	48-9124-4S-K
A2300-5250ET	N/A	48-9124-4S-K
A2360-5100ET	N/A	48-9124-AP-K
A2360-5200ET	N/A	48-9124-AP-K
A2360-5250ET	N/A	48-9124-AP-K
A2360-5251ET	N/A	48-9124-AP-K
A2360-5300ET	N/A	48-9122-AT-K
A2360-5350ET	N/A	48-9122-AT-K
A2400-5100ET	N/A	48-9124-5S-K
A2400-5250ET	N/A	48-9124-5S-K
A2550-2601	N/A	26-0082-K
A2550-5100	N/A	48-9123-7T-K
A2550-5100ET	N/A	48-9123-7T-K
A2550-5200ET	N/A	48-9123-7T-K
A2550-5250ET	N/A	48-9123-7T-K
A2550-5251ET	N/A	48-9123-7T-K
A2550-5251ET-8	N/A	48-9123-7T-K
A2550-5251ETH	N/A	48-9123-7T-K
A2550-5251ETX	N/A	48-9123-7T-K
A2550-5300ET	N/A	48-9121-7S-K
A2550-5350ET	N/A	48-9121-7S-K
A2550-5350ETH	N/A	48-9121-7S-K
A2550-5350ET-X	N/A	48-9121-7S-K
AP-1	27-J0425-5S-K	26-0056-5S-K
AP-4	27-F0313-5S-K	26-1002-5S-K-T
B12015N	27-J0425-1S-K	N/A
B23020LA5	27-J0568-2S-K	N/A
B23025R1	27-J0519-3S-K	26-0309-3S-K
B24040E	27-J0413-5S-K	N/A
B24040E	N/A	26-0314-5S-K
B24040GM	27-J0568-5S-K	26-0800-5S-K
B24040KX	27-F0313-5S-K	26-1004-5S-K
B24040LA5	27-J0568-5S-K	26-0601-5S-K
B24040LB	27-J0425-5S-K	26-0535-5S-K
B24040N	27-J0425-5S-K	26-0809-5S-K
B24040Q	27-J0425-5S-K	26-0056-5S-K

Item #	Universal Replacement	HQ Replacement
B24040R	27-J0519-5S-K	48-260036-R1
B24040S	27-J0425-5S-K	N/A
B24040T	27-J0425-5S-K	26-0809-5S-K
B24040U	27-J0568-5S-K	26-0601-5S-K
B24040V	27-J0425-5S-K	N/A
B24040W	27-J0425-5S-K	N/A
B24040XL	27-J0413-5S-K	26-0011-5S-K
B24045G	27-J0425-6S-K	26-0056-6S-K
B24055A	27-J0425-7S-K	26-0314-7S-K
B24055AR	27-J0425-7S-K	26-0314-7S-K
B24055B	27-J0425-7S-K	26-0314-7S-K
B24055B-C	27-J0425-7S-K	26-0314-7S-K
B24055C	27-M0450-7S-K	26-0213N-7S-K
B24055C1	27-J0450-7S-K	26-0313N-7S-K
B24055E	27-J0425-7S-K	26-0314-7S-K
B24055FF	27-J0425-7S-K	26-0314-7S-K
B24055G	27-J0425-7S-K	26-0314-7S-K
B24055GM	27-J0568-7S-K	26-0800-7S-K
B24055K	27-F0288-7S-K	26-1004-7S-K
B24055LA	27-J0568-7S-K	26-0601-7S-K
B24055LA2	27-J0413-7S-K	26-0736-7S-K
B24055LA5	27-J0568-7S-K	26-0601-7S-K
B24055LASD	27-J0568-7S-K	26-0601-7S-K
B24055M	27-J0425-7S-K	26-0314-7S-K
B24055MA	27-J0425-7S-K	26-0314-7S-K
B24055P	27-J0550-7S-K	N/A
B24055Q	27-J0425-7S-K	26-0056-7S-K
B24055S	27-J0425-7S-K	26-0056-7S-K
B24055SD	27-J0568-7S-K	26-0800-7S-K
B24055T	27-J0519-7S-K	N/A
B24055U	27-J0568-7S-K	26-0601-7S-K
B24055W	27-J0425-7S-K	26-0314-7S-K
B24055XL	27-J0413-7S-K	26-0011-7S-K
BAL50081	27-J0425-5S-K	26-0535-5S-K
BAL50081	27-J0425-5S-K	26-50081-K
C1100-0120	27-J0363-0S-K	N/A
C1100-0235	27-J0688-1S-K	N/A
C1100-0621-A	27-J0425-0S-K	N/A
C1100-0800	27-J0568-0S-K	N/A
C1100-0800ET	27-J0568-0S-K	N/A
C1100-0810	27-J0568-0S-K	N/A
C1100-0810ET	27-J0568-0S-K	N/A
C1100-0810W	27-J0568-0S-K	N/A
C1100-0812ET	27-G0413-0S-K	N/A
C1100-0812ET-G	27-G0413-0S-K	N/A
C1100-1200-1	27-D0450-0S-K	N/A
C1100-C2622-1	27-J0568-0S-K	N/A
C1100-C2622-1TI	27-J0568-0T-K	N/A
C1150-0535	27-J0425-1S-K	N/A
C1150-0800	27-J0568-1S-K	N/A
C1150-1000	27-J0425-1S-K	N/A
C1150-1200	27-D0450-1S-K	N/A
C1150-1200A	27-D0450-1S-K	N/A
C1200-1201A	27-D0450-2S-K	N/A
C2100-0027ET	27-J0413-0S-K	N/A

Heater Cross Reference Guide

Item #	Universal Replacement	HQ Replacement
C2100-0056	27-J0425-0S-K	N/A
C2100-0082	27-F0538-0S-K	N/A
C2100-0083	27-F0538-0S-K	N/A
C2100-C2622-2	27-J0568-FS-K	N/A
C2100-C2622-2TI	27-J0568-FT-K	N/A
C21100-0076	N/A	26-0054-K
C21100-2077	N/A	26-0054A-K
C21100-2077-TI	N/A	26-0054A-K
C21100-3077	N/A	26-0054-K
C21100-3077-TI	N/A	26-0054-K
C21100-3117	N/A	26-H3117-JT-K
C21100-3117-TI	N/A	26-H3117-JT-K
C2150-0165	27-K0550-1S-K	N/A
C2150-0304S	27-J0425-1S-K	N/A
C2150-0304SET	27-J0425-1S-K	N/A
C2150-0535	27-J0425-1S-K	N/A
C2150-0535-TTS	27-J0425-1S-K	N/A
C2150-0735	27-J0425-1S-K	N/A
C2150-0736	27-J0425-1S-K	N/A
C2150-3661-TI	N/A	26-C3182-1S
C2150-3661-TI2	N/A	26-C3182-1S
C2150-C2507-3	27-D0425-1S-K	N/A
C2150-C2622-3	27-J0568-FS-K	N/A
C2150-C2684-2	27-J0425-1S-K	N/A
C2200-0050TI	27-G0412-2T-K	N/A
C2200-0056	27-J0425-2S-K	26-0056-2S-K
C2200-0056(ET)	27-J0425-2S-K	26-0056-2S-K
C2200-0065	27-K0550-2S-K	N/A
C2200-0066	27-J0425-2S-K	N/A
C2200-0120	27-J0363-2S-K	N/A
C2200-0158	27-J0425-2S-K	N/A
C2200-0165	27-K0550-2S-K	N/A
C2200-0200	27-D0450-2S-K	N/A
C2200-0256	27-J0425-2S-K	N/A
C2200-0304	27-J0425-2S-K	N/A
C2200-0304A	27-J0425-2S-K	N/A
C2200-0304S	27-J0425-2S-K	N/A
C2200-0304SET	27-J0425-2S-K	N/A
C2200-0304SET-1	27-J0425-2S-K	N/A
C2200-0317	27-J0CTR-2S-K	N/A
C2200-0317A	27-J0CTR-2S-K	N/A
C2200-0317B	27-J0CTR-2S-K	N/A
C2200-0317B-TI	27-J0CTR-2T-K	N/A
C2200-0318	27-F0CTR-2S-K	N/A
C2200-0358ET	27-G0500-2S-K	N/A
C2200-0456	27-J0425-2S-K	N/A
C2200-0535	27-J0425-2S-K	26-0535-2S-K
C2200-0535-TPS	27-J0425-2S-K	N/A
C2200-0535-Z	27-J0425-2S-K	N/A
C2200-0535-ZTS	27-J0425-2S-K	N/A
C2200-0556	27-J0425-2S-K	N/A
C2200-0601(ET)	27-J0568-2S-K	26-0601-2S-K
C2200-0601-2	27-J0568-2S-K	N/A
C2200-0601ET-G	27-J0568-2S-K	26-0601-2S-K
C2200-0601TI	27-J0568-2T-K	N/A

Item #	Universal Replacement	HQ Replacement
C2200-0735	27-J0425-2S-K	N/A
C2200-0800(ET)	27-J0568-2S-K	26-0800-2S-K
C2200-0800-2	27-J0568-2S-K	N/A
C2200-0800ET-G	27-J0568-2S-K	26-0800-2S-K
C2200-0800TI	27-J0568-2T-K	N/A
C2200-0800-Z	27-J0568-2S-K	N/A
C2200-0801	27-J0568-2S-K	N/A
C2200-0801ET	27-J0568-2S-K	N/A
C2200-0803	27-J0568-2S-K	N/A
C2200-0804A	27-J0568-2S-K	N/A
C2200-0807	27-J0425-2S-K	N/A
C2200-0807-TI	27-J0425-2T-K	N/A
C2200-0807-TP	27-J0425-2S-K	N/A
C2200-0807-TPS	27-J0425-2S-K	N/A
C2200-0807-ZTS	27-J0425-2S-K	N/A
C2200-0810	27-J0465-2S-K	N/A
C2200-0810ET	27-J0465-2S-K	N/A
C2200-0812ET	27-G0413-2S-K	N/A
C2200-0812ET-G	27-G0413-2S-K	N/A
C2200-0862	27-G0469-2S-K	N/A
C2200-0865	27-G0425-2S-K	N/A
C2200-1200	27-D0450-2S-K	N/A
C2200-1203-1	27-D0446-2S-K	N/A
C2200-2300ET	27-F0575-2S-K	26-2300-2S-K
C2200-2622-2	27-D0450-2S-K	N/A
C2200-5000-1	27-J0425-2S-K	N/A
C2200-5003(ET)	27-J0568-2S-K	N/A
C2200-5003ET-1	27-J0568-2S-K	N/A
C2200-C3330-3A	27-J0568-2S-K	N/A
C2200-C3330-3C	27-J0568-2S-K	N/A
C2220-0865	27-G0500-2S-K	N/A
C2250-0000A-BX	N/A	26-0000ABX-3S-K
C2250-0002	27-J0425-3S-K	N/A
C2250-0002ET	27-J0425-3S-K	N/A
C2250-0003	27-J0463-3S-K	N/A
C2250-0011	N/A	26-0011-3S-K
C2250-0013	27-M0425-3S-K	N/A
C2250-0035	27-J0425-3S-K	N/A
C2250-0056	27-J0425-3S-K	N/A
C2250-0065	27-K0550-3S-K	N/A
C2250-0066	27-J0425-3S-K	N/A
C2250-0071	27-J0425-3S-K	N/A
C2250-0072	27-J0425-3S-K	N/A
C2250-0073	27-J0425-3S-K	N/A
C2250-0136-SJO	27-J0425-3S-K	N/A
C2250-0165	27-K0550-3S-K	26-0165-3S-K
C2250-0166	27-J0425-3S-K	N/A
C2250-0166ET	27-J0425-3S-K	N/A
C2250-0256	27-J0425-3S-K	N/A
C2250-0304	27-J0425-3S-K	26-0314-7S-K
C2250-0304ET	27-J0425-3S-K	26-0314-7S-K
C2250-0304ET-PD	27-J0425-3S-K	26-0314-7S-K
C2250-0304S	27-J0425-3S-K	26-0314-7S-K
C2250-0304SET	27-J0425-3S-K	26-0314-7S-K
C2250-0304SET-1	27-J0425-3S-K	26-0314-7S-K

Heater Cross Reference Guide

Item #	Universal Replacement	HQ Replacement
C2250-0309ET	27-J0519-7S-K	26-0309-3S-K
C2250-0358ET	27-G0500-3S-K	N/A
C2250-0456	27-J0425-3S-K	N/A
C2250-0517	27-J0425-3S-K	N/A
C2250-0517-TI	27-J0425-3T-K	N/A
C2250-0519	27-J0425-3S-K	N/A
C2250-0535	27-J0425-3S-K	N/A
C2250-0601(ET)	27-J0568-3S-K	26-0601-3S-K
C2250-0621	27-J0425-3S-K	N/A
C2250-0621-A	27-J0425-3S-K	N/A
C2250-0735	27-J0425-3S-K	N/A
C2250-0736	27-J0425-3S-K	26-0736-3S-K
C2250-0736NS	27-J0425-3S-K	N/A
C2250-0737	27-J0425-3S-K	N/A
C2250-0800(ET)	27-J0568-3S-K	26-0800-3S-K
C2250-0800A	27-J0568-3S-K	N/A
C2250-0801A	27-J0568-3S-K	N/A
C2250-0802	27-J0568-3S-K	N/A
C2250-0802A	27-J0568-3S-K	26-0802A-2S-K
C2250-0803	27-J0568-3S-K	N/A
C2250-0803A	27-J0568-3S-K	N/A
C2250-0804A	27-J0568-3S-K	N/A
C2250-0807-TI-A	27-J0425-3T-K	N/A
C2250-1002(ET)	27-F0288-3S-K	26-1002-3S-K
C2250-2001	27-J0519-3S-K	N/A
C2250-2001-1	27-J0519-3S-K	26-2001-3S-K
C2270-0011-TI	N/A	26-0011-3S-K
C2270-0056	27-J0425-CS-K	N/A
C2270-0056ET	27-J0425-CS-K	N/A
C2270-0056-S	27-J0425-CS-K	N/A
C2270-0316TI-1	27-J0CTR-3T-K	N/A
C2270-0316TI-EU	27-J0CTR-3T-K	N/A
C2270-0807	27-J0425-CS-K	N/A
C2270-5000-1	27-J0425-CS-K	N/A
C2300-0000	27-J0425-4S-K	N/A
C2300-0000A-BX	N/A	26-0000ABX-4S-K
C2300-0002	27-D0288-4S-K	N/A
C2300-0010(ET)	27-J0413-4S-K	26-0010-4S-K
C2300-0010TI	27-J0413-4T-K	N/A
C2300-0010Z	27-J0413-4S-K	N/A
C2300-0013	27-M0425-4S-K	N/A
C2300-0024(ET)	27-J0413-4S-K	26-0024-4S-K
C2300-0024TI	27-J0413-4T-K	N/A
C2300-0027ET	27-J0413-4S-K	N/A
C2300-0027-Z	27-J0413-4S-K	N/A
C2300-0028ET	27-J0413-4S-K	26-0028-4S-K
C2300-0056(ET)	27-J0425-4S-K	26-0056-4S-K
C2300-0104-Z	27-F0CTR-4S-K	N/A
C2300-0137-C	27-J0CTR-4S-K	N/A
C2300-0205	27-D0288-4S-K	N/A
C2300-0213N	27-M0450-4S-K	N/A
C2300-0231N	27-M0450-4S-K	26-0213N-4S-K
C2300-0256	27-J0425-4S-K	N/A
C2300-0304	27-J0425-4S-K	N/A
C2300-0304A	27-J0425-4S-K	N/A

Item #	Universal Replacement	HQ Replacement
C2300-0304SET-1	27-J0425-4S-K	N/A
C2300-0304TI	27-J0425-4T-K	N/A
C2300-0307ET	27-J0519-4S-K	N/A
C2300-0309ET	27-J0519-4S-K	26-0309-4S-K
C2300-0310	27-J0535-4S-K	N/A
C2300-0314	27-J0425-4S-K	N/A
C2300-0317	27-J0CTR-4S-K	N/A
C2300-0317A	27-J0CTR-4S-K	N/A
C2300-0317B	27-J0CTR-4S-K	N/A
C2300-0317B-TI	27-J0CTR-4S-K	N/A
C2300-0317D	27-J0CTR-4S-K	N/A
C2300-0319ET	27-J0519-4S-K	N/A
C2300-0517	27-J0438-4S-K	26-0517-4S-K
C2300-0534	27-J0688-4S-K	N/A
C2300-0535	27-J0425-4S-K	26-0535-4S-K
C2300-05351ET	27-J0425-4S-K	N/A
C2300-05351ET-1	27-J0425-4S-K	N/A
C2300-05352ET	27-J0425-4S-K	N/A
C2300-0535ET	27-J0425-4S-K	26-0535-4S-K
C2300-0535-TI	27-J0425-4T-K	N/A
C2300-0535-TPS	27-J0425-4S-K	26-0535-4S-KP
C2300-0540	27-J0425-4S-K	N/A
C2300-0601	27-J0568-4S-K	26-0601-4S-K
C2300-0601-2	27-J0568-4S-K	26-0601-4S-K
C2300-0601ET	27-J0568-4S-K	26-0601-4S-K
C2300-0601ET-G	27-J0568-4S-K	26-0601-4S-K
C2300-0735	27-J0425-4S-K	N/A
C2300-0735ET	27-J0425-4S-K	N/A
C2300-0739ET	27-J0425-4S-K	N/A
C2300-0742	27-J0500-4S-K	N/A
C2300-0800	27-J0568-4S-K	26-0800-4S-K
C2300-0800-1	27-J0568-4S-K	N/A
C2300-0800-2	27-J0568-4S-K	N/A
C2300-0800-2Z	27-J0568-4S-K	N/A
C2300-0800ET	27-J0568-4S-K	26-0800-4S-K
C2300-0800ET-G	27-J0568-4S-K	N/A
C2300-0801ET	27-J0568-4S-K	N/A
C2300-0807	27-J0425-4S-K	26-58118-K
C2300-0807-PS1	27-J0425-4S-K	N/A
C2300-0807-S1	27-J0425-4S-K	N/A
C2300-0807-TI1	27-J0425-4T-K	26-55626-K
C2300-0807-TITP	27-J0425-4T-K	26-55626-K
C2300-0807-TP	27-J0425-4S-K	26-58118-K
C2300-0807-TPS	27-J0425-4S-K	26-58118-K
C2300-0807-TPS1	27-J0425-4S-K	26-58118-K
C2300-0807-TTS	27-J0425-4T-K	26-55626-K
C2300-0807-Z	27-J0425-4S-K	26-58118-K
C2300-0807-ZTS	27-J0425-4S-K	26-58118-K
C2300-0808	27-J0425-4S-K	N/A
C2300-0808-TI	27-J0425-4T-K	N/A
C2300-0809-1	27-J0425-4S-K	N/A
C2300-0809-TI	27-J0425-4T-K	N/A
C2300-0809-TPS	27-J0425-4S-K	26-0809-4S-KP
C2300-0872	27-J0688-4S-K	N/A
C2300-1002(ET)	27-F0288-4S-K	26-1002-4S-K

Heater Cross Reference Guide

Item #	Universal Replacement	HQ Replacement
C2300-1002-1	27-F0288-4S-K	N/A
C2300-1004	27-F0288-4S-K	N/A
C2300-1008ET	27-L0700-4S-K	26-1008-4S-K
C2300-1054-2	27-J0CTR-4S-K	N/A
C2300-1056	27-J0425-4S-K	N/A
C2300-1206	27-G0413-3S-K	26-1206-5S-K
C2300-2100	27-D0425-4S-K	N/A
C2300-2300ET	27-F0575-4S-K	26-2300-4S-K
C2300-5000-1	27-J0425-4S-K	N/A
C2300-5000-1Z	27-J0425-4S-K	N/A
C2300-5000-4TI	27-J0425-4T-K	N/A
C2300-5002-4TI	27-J0568-4T-K	N/A
C2300-5003	27-J0568-4S-K	N/A
C2300-5003Z	27-J0568-4S-K	N/A
C2300-C2939-1	27-J0425-4S-K	N/A
C2341-3	N/A	N/A
C2350-0517	27-J0437-AT-K	N/A
C2360-0000	27-J0425-AT-K	N/A
C2360-0000A-BP	27-J0CTR-AT-K	N/A
C2360-0317D	27-J0CTR-AT-K	N/A
C2360-0317D-TI	27-J0CTR-AT-K	N/A
C2360-0601	27-J0568-AT-K	26-0601-AS-K
C2360-0601-1	27-J0568-AT-K	26-0601-AS-K
C2360-0601-2	27-J0568-AT-K	26-0601-AS-K
C2360-0601ET	27-J0568-AT-K	26-0601-AS-K
C2360-0601ET-G	27-J0568-AT-K	N/A
C2360-0601TI	27-J0568-AT-K	26-0601-KT-K
C2360-0601TI-G	27-J0568-AT-K	26-0601-KT-K
C2360-0800(ET)	27-J0568-AT-K	26-0800-AS-K
C2360-0800-2	27-J0568-AT-K	N/A
C2360-0800ET-G	27-J0568-AT-K	N/A
C2360-0800TI	27-J0568-AT-K	N/A
C2360-0828	27-J0625-AT-K	N/A
C2360-0862	27-G0469-AT-K	N/A
C2360-0865	27-G0500-AT-K	N/A
C2360-0910	27-G0350-AT-K	N/A
C2360-0910ET	27-G0350-AT-K	N/A
C2360-1002(ET)	27-F0288-AT-K	26-1002-AS-K
C2360-1002-1	27-F0288-AT-K	N/A
C2360-1204	27-G0500-AT-K	N/A
C2360-5000-1	27-J0425-AT-K	N/A
C2360-5003ET-1	27-J0568-AT-K	N/A
C2400-0000	27-J0425-5S-K	N/A
C2400-0000A-BX	N/A	26-0000ABX-5S-K
C2400-0001	27-F0425-5S-K	26-0001-5S-K
C2400-0001ET	27-F0425-5S-K	N/A
C2400-0002/ET	27-J0425-5S-K	26-0002-5S-K
C2400-0011	N/A	26-0011-5S-K
C2400-0011(Ti)	N/A	26-0011-F-PS-K
C2400-0011-TI	N/A	26-0011-F-PS-K
C2400-0013	27-M0425-5S-K	N/A
C2400-0024ET	27-J0413-5S-K	26-0024-5S-K
C2400-0027ET	27-J0413-5S-K	26-0028-5S-K
C2400-0028ET	27-J0413-5S-K	26-0028-5S-K
C2400-0035	27-J0425-5S-K	N/A

Item #	Universal Replacement	HQ Replacement
C2400-0036ET-C	27-F0CTR-5S-K	N/A
C2400-0056(ET)	27-J0425-5S-K	26-0056-5S-K
C2400-0056-S	27-J0425-5S-K	N/A
C2400-0066	27-J0425-5S-K	N/A
C2400-0066ET	27-J0425-5S-K	N/A
C2400-0066ET+	27-J0425-5S-K	N/A
C2400-0066ET-A	27-J0425-5S-K	N/A
C2400-0073(ET)	27-J0425-5S-K	N/A
C2400-0073-S	27-J0425-5S-K	N/A
C2400-0073SET	27-J0425-5S-K	N/A
C2400-0080	27-D0253-5S-K	N/A
C2400-0102	27-F0288-5S-K	N/A
C2400-0103	27-J0463-5S-K	N/A
C2400-0103TT	27-F0CTR-5T-K	48-9150-5P-K
C2400-0104	27-F0288-5S-K	N/A
C2400-0104-A	27-F0288-5S-K	N/A
C2400-0133	27-J0425-5S-K	N/A
C2400-0135ET-C	27-J0CTR-5S-K	N/A
C2400-0136ET-C	27-J0CTR-5S-K	N/A
C2400-0136ET-SJO	27-J0CTR-5S-K	N/A
C2400-0136-SJO	27-J0CTR-5S-K	N/A
C2400-0150ET+	27-F0463-5S-K	N/A
C2400-0158	27-J0425-5S-K	N/A
C2400-0165	27-K0550-5S-K	26-0165-5S-K
C2400-0165ET	27-K0550-5S-K	N/A
C2400-0171	27-J0425-5S-K	N/A
C2400-0173	27-J0425-5S-K	N/A
C2400-0213N	27-M0450-5S-K	26-0213N-5S-K
C2400-0256	27-J0425-5S-K	N/A
C2400-0256(ET)	27-J0425-5S-K	N/A
C2400-0267(ET)	27-J0519-5S-K	N/A
C2400-0281	27-K0238-5S-K	N/A
C2400-0302	27-J0425-5S-K	N/A
C2400-0303A	27-J0431-5S-K	N/A
C2400-0303B	27-J0431-5S-K	N/A
C2400-0304(ET)	27-J0425-5S-K	26-0314-5S-K
C2400-0304-2	27-J0425-5S-K	N/A
C2400-0304-3	27-J0425-5S-K	N/A
C2400-0304ET-PD	27-J0425-5S-K	N/A
C2400-0304SET	27-J0425-5S-K	N/A
C2400-0304SET-1	27-J0425-5S-K	N/A
C2400-0304TI	27-J0425-5T-K	N/A
C2400-0307(ET)	27-J0425-5S-K	26-0314-5S-K
C2400-0308	27-J0563-5S-K	N/A
C2400-0308ET	27-J0563-5S-K	N/A
C2400-0309	27-J0519-5S-K	N/A
C2400-0309ET	27-J0519-5S-K	N/A
C2400-0310	27-J0535-5S-K	N/A
C2400-0310-1	27-J0535-5S-K	N/A
C2400-0313N	27-J0450-5S-K	26-0313N-5S-K
C2400-0314(ET)	27-J0425-5S-K	26-0314-5S-K
C2400-0315	27-J0425-5S-K	26-0315-5S-K
C2400-0315-60	27-J0425-5S-K	N/A
C2400-0315ET	27-J0425-5S-K	N/A
C2400-0315S-TI	27-J0425-5T-K	N/A

Heater Cross Reference Guide

Item #	Universal Replacement	HQ Replacement
C2400-0316	27-J0CTR-5S-K	26-0316-LP-KB
C2400-0316ET	27-J0CTR-5S-K	26-0316-LP-KB
C2400-0317	27-J0CTR-5S-K	N/A
C2400-0317A	27-J0CTR-5S-K	N/A
C2400-0317B	27-J0CTR-5S-K	N/A
C2400-0317B-TI	27-J0CTR-5T-K	N/A
C2400-0319ET	27-J0519-5S-K	N/A
C2400-0320	27-G0CTR-5S-K	N/A
C2400-0333ET	27-J0425-5S-K	N/A
C2400-0344A	27-J0425-5S-K	N/A
C2400-0344A-TI	27-J0425-5T-K	N/A
C2400-0356ET	27-J0425-5S-K	N/A
C2400-0435	27-J0425-5S-K	N/A
C2400-0456(ET)	27-J0425-5S-K	26-0056-5S-K
C2400-0503	27-J0425-5S-K	N/A
C2400-0503-TPS	27-J0425-5S-K	N/A
C2400-0517	27-J0438-5S-K	26-0517-5P-K
C2400-0534	27-J0688-5S-K	N/A
C2400-0535	27-J0425-5S-K	26-0535-5S-K
C2400-0535	27-J0425-5S-K	26-50081-K
C2400-05351ET	27-J0425-5S-K	N/A
C2400-05351ET-1	27-J0425-5S-K	N/A
C2400-05352ET	27-J0425-5S-K	N/A
C2400-0535ET	27-J0425-5S-K	26-0535-5S-K
C2400-0535-TI	27-J0425-5T-K	N/A
C2400-0535-TPS	27-J0425-5S-K	26-0535-5S-KP
C2400-0535-TPS	27-J0425-5S-K	26-58081-K
C2400-0535-TPSH	27-J0425-5S-K	26-58081-K
C2400-0537ETT+	27-J0425-5S-K	N/A
C2400-0537TT+	27-J0425-5S-K	N/A
C2400-0537XT+	27-J0425-5S-K	N/A
C2400-0538	27-J0425-5S-K	N/A
C2400-0556	27-J0425-5S-K	26-0056-5S-K
C2400-0601(ET)	27-J0568-5S-K	26-0601-5S-K
C2400-0601-2	27-J0568-5S-K	26-0601-5S-K
C2400-0601ET	27-J0568-5S-K	26-0601-5S-K
C2400-0601ET-2	27-J0568-5S-K	26-0601-5S-K
C2400-0601ET-G	27-J0568-5S-K	26-0601-5S-K
C2400-0601TI	27-J0568-5T-K	N/A
C2400-0621-A	27-J0425-5S-K	N/A
C2400-0735	27-J0425-5S-K	N/A
C2400-0735ET	27-J0425-5S-K	N/A
C2400-0735TT	27-J0425-5S-K	N/A
C2400-0736	27-J0425-5S-K	N/A
C2400-0739ET	27-J0425-5S-K	26-0739-5SD-K
C2400-0739ET+	27-J0425-5S-K	26-0739-5SD-K
C2400-0739ET-1	27-J0425-5S-K	26-0739-5SD-K
C2400-0739T	27-J0425-5S-K	26-0739-5SD-K
C2400-0739TT	27-J0425-5S-K	26-0739-5SD-K
C2400-0739TT+	27-J0425-5S-K	26-0739-5SD-K
C2400-0739TT+2	27-J0425-5S-K	26-0739-5SD-K
C2400-0739X	27-J0425-5S-K	26-0739-5SD-K
C2400-0739XT	27-J0425-5S-K	26-0739-5SD-K
C2400-0739XT+	27-J0425-5S-K	26-0739-5SD-K
C2400-0742	27-J0500-5S-K	N/A

Item #	Universal Replacement	HQ Replacement
C2400-0800(ET)	27-J0568-5S-K	26-0800-5S-K
C2400-0800-2	27-J0568-5S-K	26-0800-5S-K
C2400-0800-2TI	27-J0568-5T-K	26-0800-5T-K
C2400-0800-2Z	27-J0568-5S-K	26-0800-5S-K
C2400-0800A	27-J0568-5S-K	26-0800-5S-K
C2400-0800D	27-J0568-5S-K	26-0800-5S-K
C2400-0800ET-1	27-J0568-5S-K	26-0800-5S-K
C2400-0800ET-2	27-J0568-5S-K	26-0800-5S-K
C2400-0800ETA	27-J0568-5S-K	26-0800-5S-K
C2400-0800ET-G	27-J0568-5S-K	26-0800-5S-K
C2400-0800ET-S2	27-J0568-5S-K	26-0800-5S-K
C2400-0800ETW-G	27-J0568-5S-K	26-0800-5S-K
C2400-0800TI	27-J0568-5T-K	26-0800-5T-K
C2400-0800TI-G	27-J0568-5T-K	26-0800-5T-K
C2400-0800TT	27-J0568-5S-K	26-0800-5T-K
C2400-0801	27-J0568-5S-K	N/A
C2400-0801A	27-J0568-5S-K	N/A
C2400-0801ET	27-J0568-5S-K	N/A
C2400-0801T	27-J0568-5S-K	N/A
C2400-0802	27-J0568-5S-K	26-0802-5S-K
C2400-0802A	27-J0568-5S-K	26-0802-5S-K
C2400-0802ET	27-J0568-5S-K	26-0802-5S-K
C2400-0803	27-J0568-5S-K	N/A
C2400-0803A	27-J0568-5S-K	N/A
C2400-0804A	27-J0568-5S-K	N/A
C2400-0807	27-J0425-5S-K	26-58104-K
C2400-0807-825	27-J0425-5S-K	26-55625-K
C2400-0807-F	27-J0425-5S-K	26-58104-K
C2400-0807-TEP	27-J0425-5S-K	26-55625-K
C2400-0807-TI	27-J0425-5T-K	26-55625-K
C2400-0807-TITP	27-J0425-5T-K	26-55625-K
C2400-0807-TP	27-J0425-5S-K	26-55625-K
C2400-0807-TPS	27-J0425-5S-K	26-58104-K
C2400-0807-TPS1	27-J0425-5S-K	26-58104-K
C2400-0807-TPSH	27-J0425-5S-K	26-58104-K
C2400-0807-TTS	27-J0425-5S-K	26-55625-K
C2400-0807-Z	27-J0425-5S-K	26-55625-K
C2400-0807-ZTS	27-J0425-5S-K	26-55625-K
C2400-0808	27-J0425-5S-K	N/A
C2400-0808-TI	27-J0425-5T-K	N/A
C2400-0809	27-J0425-5S-K	26-0809-5S-K
C2400-0809	27-J0425-5S-K	26-58029-K
C2400-0809-1	27-J0425-5S-K	N/A
C2400-0809-TPS	27-J0425-5S-K	26-0809-5S-KSP
C2400-0809-TPS	27-J0425-5S-K	26-58048-K
C2400-0817	27-J0425-5S-K	N/A
C2400-0835	N/A	26-58001-K
C2400-0850ET	27-J0438-5S-K	N/A
C2400-0862	27-G0469-5S-K	N/A
C2400-0865	27-G0500-5S-K	N/A
C2400-1000	27-J0425-5S-K	N/A
C2400-1000ET	27-J0425-5S-K	N/A
C2400-1002(ET)	27-F0288-5S-K	26-1002-5S-K-T
C2400-1004	27-F0288-5S-K	N/A
C2400-1004/TI	27-F0288-5T-K	26-1004-5S-K

Heater Cross Reference Guide

Item #	Universal Replacement	HQ Replacement
C2400-1004A	27-F0288-5S-K	N/A
C2400-1054	27-J0CTR-5S-K	N/A
C2400-1057-1	27-G0500-5S-K	N/A
C2400-1200A	27-D0450-5S-K	N/A
C2400-1204	27-D0457-5S-K	N/A
C2400-1206	27-G0413-5S-K	26-1206-5S-K
C2400-1206-A	27-G0413-5S-K	N/A
C2400-1206ET	27-G0413-5S-K	N/A
C2400-1226	27-J0544-5S-K	N/A
C2400-1226-1	27-J0544-5S-K	N/A
C2400-1226-1A	27-J0544-5S-K	N/A
C2400-1226-A	27-J0544-5S-K	N/A
C2400-1227	27-J0519-5S-K	26-1227-5S-K
C2400-1322	27-J0519-5S-K	N/A
C2400-1322-B	27-J0519-5S-K	N/A
C2400-1322-TI	27-J0519-5T-K	N/A
C2400-1322-Z	27-J0519-5S-K	N/A
C2400-2001	27-J0519-5S-K	26-2001-5S-K
C2400-2300	27-F0575-5S-K	N/A
C2400-2300ET	27-F0575-5S-K	26-2300-5S-K
C2400-2311	27-F0575-5S-K	N/A
C2400-2311ET	27-F0575-5S-K	N/A
C2400-3024-TI	27-J0425-5T-K	N/A
C2400-3661-TI	N/A	26-C3160-2S
C2400-3661-TI1	N/A	26-C3160-2S
C2400-3661-TI2	N/A	26-C3160-2S
C2400-5000	27-J0425-5S-K	26-5000-5S-K
C2400-5000-1	27-J0425-5S-K	26-5000-5S-K
C2400-5000-1Z	27-J0425-5T-K	26-5000-5S-K
C2400-5000-2	27-J0425-5S-K	26-5000-5S-K
C2400-5000-2B	27-J0425-5S-K	26-5000-5S-K
C2400-5000-3	27-J0425-5S-K	26-5000-5S-K
C2400-5000-3TI	27-J0425-5T-K	N/A
C2400-5000-BI	27-J0425-5S-K	26-5000-5S-K
C2400-5000-P	27-J0425-5S-K	26-5000-5S-K
C2400-5002	27-J0568-5S-K	N/A
C2400-5003	27-J0568-5S-K	N/A
C2400-93S1-BF	27-F0CTR-5S-K	N/A
C2400-93S1-CBF	27-F0CTR-5S-K	N/A
C2400-93S1-EBF	27-F0CTR-5S-K	N/A
C2400-93S1-ECBF	27-F0CTR-5S-K	N/A
C2400-93S1-TCBF	27-F0CTR-5S-K	N/A
C2400-93S1-TIBF	27-F0CTR-5T-K	N/A
C2400-93S2-BF	27-F0CTR-5S-K	N/A
C2400-93S2-CBF	27-F0CTR-5S-K	N/A
C2400-93S2-EBF	27-F0CTR-5S-K	N/A
C2400-93S2-ECBF	27-F0CTR-5S-K	N/A
C2400-93S2-TCBF	27-F0CTR-5S-K	N/A
C2400-93S2TCBF2	27-F0CTR-5S-K	N/A
C2400-93S2-TIBF	27-F0CTR-5T-K	N/A
C2400-C2278-1	27-F0475-5S-K	26-C2278-1-5S-K
C2400-C2550-2	27-J0425-5S-K	N/A
C2400-C2695-1	27-J0568-5S-K	26-3330-5S-K
C2400-C2839-2	27-J0425-5S-K	N/A
C2400-C2939-2	27-J0425-5S-K	N/A

Item #	Universal Replacement	HQ Replacement
C2400-C2950-1	27-J0425-5S-K	N/A
C2400-C3037-1	N/A	26-H3037-5S-K
C2400-C3037-2	N/A	26-H3037-5S-K
C2400-C3083-1	27-J0568-5S-K	N/A
C2400-C3107-1	27-J0568-5S-K	N/A
C2400-C3145-1	27-J0568-5S-K	N/A
C2400-C3149-1	27-J0568-5S-K	N/A
C2400-C3330-1	27-J0568-5S-K	26-3330-5S-K
C2400-C3330-1A	27-J0568-5S-K	26-3330-5S-K
C2400-C3330-1C	27-J0568-5S-K	26-3330-5S-K
C2400-C3452-3	27-J0425-5S-K	
C2400-C3464-1	27-J0568-5S-K	N/A
C2450-0002	27-J0425-6S-K	N/A
C2450-0010ET	27-J0413-6S-K	26-0010-6S-K
C2450-0015	27-F0368-6S-K	N/A
C2450-0021	N/A	26-H0021-6S-K
C2450-0022	N/A	26-H0021-6S-K
C2450-0024ET	27-J0413-6S-K	N/A
C2450-0036-C	27-F0CTR-6S-K	N/A
C2450-0036ET-C	27-F0CTR-6S-K	N/A
C2450-0057-BZ	N/A	26-0000ABX-6S-K
C2450-0066ET	27-J0425-6S-K	N/A
C2450-0103	27-J0463-6S-K	N/A
C2450-0103ET+	27-F0CTR-6S-K	N/A
C2450-0135-C	N/A	26-H0136-6S-K
C2450-0135ET-C	N/A	26-H0136-6S-K
C2450-0136-BF	N/A	26-H0136-6S-K
C2450-0136-C	N/A	26-H0136-6S-K
C2450-0136ET-C	N/A	26-H0136-6S-K
C2450-0150	27-F0463-6S-K	N/A
C2450-0150ET	27-F0463-6S-K	N/A
C2450-0165(ET)	27-K0550-6S-K	N/A
C2450-0302	27-J0425-6S-K	N/A
C2450-0304ET	27-J0425-6S-K	N/A
C2450-0307(ET)	27-J0519-6S-K	48-260034-R1
C2450-0307ET+	27-J0519-6S-K	N/A
C2450-0309	27-J0519-6S-K	N/A
C2450-0309ET	27-J0519-6S-K	N/A
C2450-0319ET	27-J0519-6S-K	N/A
C2450-0321	27-F0CTR-6S-K	N/A
C2450-0521	27-J0425-6S-K	N/A
C2450-0521-B	27-J0425-6S-K	N/A
C2450-0621	27-J0425-6S-K	N/A
C2450-0621-A	27-J0425-6S-K	N/A
C2450-0735	27-J0425-6S-K	N/A
C2450-0800ET	27-J0568-6S-K	N/A
C2450-0801	27-J0568-6S-K	N/A
C2450-0801ET	27-J0568-6S-K	N/A
C2450-0802ET	27-J0568-6S-K	26-0802-6S-K
C2450-0807-AS	27-J0425-6S-K	N/A
C2450-0850ET	27-J0438-6S-K	N/A
C2450-0850F-ET	27-J0438-6S-K	N/A
C2450-0862ET	27-G0469-6S-K	N/A
C2450-0863	27-G0413-6S-K	N/A
C2450-1004	27-F0313-6S-K	26-1004-6S-K

Heater Cross Reference Guide

Item #	Universal Replacement	HQ Replacement
C2450-1008ET	N/A	26-1008-6S-K
C2450-1008TI	N/A	26-1008-6S-K
C2450-1227	27-J0519-6S-K	N/A
C2450-5000	27-J0425-6S-K	N/A
C2450-5000-1	27-J0425-6S-K	N/A
C2450-5000-P	27-J0425-6S-K	N/A
C2500-0601-2	27-J0568-7S-K	N/A
C2500-0601ET-2	27-J0568-7S-K	N/A
C2500-0601TI	27-J0568-7T-K	N/A
C2500-0800-2	27-J0568-7S-K	N/A
C2500-0800ET-2	27-J0568-7S-K	N/A
C2500-0800TI	27-J0568-7T-K	N/A
C2500-1227	27-J0519-7S-K	N/A
C2500-C2958-1	27-J0425-7S-K	N/A
C2500-C3024-1	27-J0425-7S-K	N/A
C2500-C3330-TI	27-J0568-7T-K	N/A
C2550-0000	27-J0425-7S-K	N/A
C2550-0000A-BX	N/A	26-0000ABX-7S-K
C2550-0000A-BX1	N/A	26-0000ABX-7S-K
C2550-0000-BPS	N/A	26-0000ABX-7S-K
C2550-0000ETBPS	N/A	26-0000ABX-7S-K
C2550-0001	27-F0425-7S-K	N/A
C2550-0001ET	27-F0425-7S-K	N/A
C2550-0001ET-HQ	27-F0425-7S-K	N/A
C2550-0002/ET	27-J0425-7S-K	26-0002-7S-K
C2550-0003	27-J0463-7S-K	N/A
C2550-0008	N/A	26-1008-7S-K
C2550-0008ET	N/A	26-1008-7S-K
C2550-0008ET+	N/A	26-1008-7S-K
C2550-0010(ET)	27-J0413-7S-K	26-0010-7S-K
C2550-0010T	27-J0413-7S-K	26-0010-7S-K
C2550-0011	N/A	26-0011-7S-K
C2550-0011TI	N/A	26-0011-F-RS-K
C2550-0011-TIP	N/A	26-0011-F-RS-K
C2550-0013	N/A	26-0213N-7S-K
C2550-0014ET	27-V310-7T-K	N/A
C2550-0015	27-F0368-7S-K	N/A
C2550-0021	N/A	26-H0021-7S-K
C2550-0022	N/A	26-H0021-7S-K
C2550-0023	N/A	26-H0021-7S-K
C2550-0024ET	27-J0413-7S-K	26-0024-7S-K
C2550-0028ET	27-J0413-7S-K	26-0028-7S-K
C2550-0033(with box)	27-J0425-7S-K	N/A
C2550-0033ET	27-J0425-7S-K	N/A
C2550-0033ET+	27-J0425-7S-K	N/A
C2550-0033-R	27-J0425-7S-K	N/A
C2550-0035	27-J0425-7S-K	N/A
C2550-0035	27-J0425-7S-K	26-0035-7S-K
C2550-0036	27-F0CTR-7S-K	N/A
C2550-0036ET-C	27-F0CTR-7S-K	N/A
C2550-0056(ET)	27-J0425-7S-K	26-0056-7S-K
C2550-0056-A	27-J0425-7S-K	26-0056-7S-K
C2550-0056-B	27-J0425-7S-K	26-0056-7S-K
C2550-0056-R	27-J0425-7S-K	26-0056-7S-K
C2550-0056-S	27-J0425-7S-K	26-0056-7S-K

Item #	Universal Replacement	HQ Replacement
C2550-0057-BZ	N/A	26-0000ABX-7S-K
C2550-0065	27-K0550-7S-K	N/A
C2550-0065ET	27-K0550-7S-K	N/A
C2550-0066(ET)	27-J0425-7S-K	N/A
C2550-0066-A	27-J0425-7S-K	N/A
C2550-0066BC	27-J0425-7S-K	N/A
C2550-0066ET+	27-J0425-7S-K	N/A
C2550-0066ET-A	27-J0425-7S-K	N/A
C2550-0066ET-AP	27-J0425-7S-K	N/A
C2550-0066P	27-J0425-7S-K	N/A
C2550-0066-S4-ET	27-J0425-7S-K	N/A
C2550-0067	27-K0500-7S-K	N/A
C2550-0067ET	27-K0500-7S-K	N/A
C2550-0071	27-J0425-7S-K	N/A
C2550-0071ET	27-J0425-7S-K	N/A
C2550-0072	27-J0425-7S-K	N/A
C2550-0073	27-J0425-7S-K	N/A
C2550-0073SET	27-J0425-7S-K	N/A
C2550-0076	N/A	26-0053-K
C2550-0102ET	27-G0288-7S-K	N/A
C2550-0103	27-J0463-7S-K	N/A
C2550-0103ET	27-F0CTR-7S-K	N/A
C2550-0103ET-X	27-F0CTR-7S-K	N/A
C2550-0103TT	27-F0CTR-7T-K	48-9120-7P-K
C2550-0103TT-1	27-F0CTR-7T-K	48-9120-7P-K
C2550-0103TT-2	27-F0CTR-7T-K	48-9120-7P-K
C2550-0103-Z	27-F0CTR-7S-K	N/A
C2550-0104	27-F0288-7S-K	N/A
C2550-0113	27-M0450-7S-K	26-0213N-7S-K
C2550-0120	27-J0363-7S-K	N/A
C2550-0133	27-J0425-7S-K	N/A
C2550-0135	27-J0CTR-7S-K	N/A
C2550-0135-C	27-J0CTR-7S-K	N/A
C2550-0135ET	27-J0CTR-7S-K	N/A
C2550-0135ET-C	27-J0CTR-7S-K	N/A
C2550-0136(ET-C)	27-J0CTR-7S-K	N/A
C2550-0154	27-L0550-7S-K	26-0155-7S-K
C2550-0155	27-L0550-7S-K	26-0155-7S-K
C2550-0157	27-L0550-7S-K	26-0155-7S-K
C2550-0165	N/A	26-0165-7S-K
C2550-0165(ET)	27-K0550-7S-K	26-0165-7S-K
C2550-0166	27-J0425-7S-K	N/A
C2550-0166ET	27-J0425-7S-K	N/A
C2550-0203	27-F0315-7S-K	N/A
C2550-0213	27-M0450-7S-K	26-0213N-7S-K
C2550-0213ET	27-M0450-7S-K	26-0213N-7S-K
C2550-0213N	27-M0450-7S-K	26-0213N-7S-K
C2550-0233ET	27-J0425-7S-K	N/A
C2550-0256(ET)	27-J0425-7S-K	N/A
C2550-0266	27-J0425-7S-K	N/A
C2550-0266ET	27-J0425-7S-K	N/A
C2550-0266ETP	27-J0425-7S-K	N/A
C2550-0267ET	27-J0519-7S-K	N/A
C2550-0302	27-J0425-7S-K	N/A
C2550-0303A	27-J0431-7S-K	N/A

Heater Cross Reference Guide

Item #	Universal Replacement	HQ Replacement
C2550-0303B	27-J0431-7S-K	N/A
C2550-0304(A/ET)	27-J0425-7S-K	26-0314-7S-K
C2550-0304-1	27-J0425-7S-K	N/A
C2550-0304-2	27-J0425-7S-K	N/A
C2550-0304A-TB	27-J0425-7S-K	N/A
C2550-0304ET+	27-J0425-7S-K	N/A
C2550-0304ET-50	27-J0425-7S-K	N/A
C2550-0304ET-PD	27-J0425-7S-K	N/A
C2550-0304N	27-J0425-7S-K	N/A
C2550-0304-PD	27-J0425-7S-K	N/A
C2550-0304S	27-J0425-7S-K	N/A
C2550-0304SET	27-J0425-7S-K	N/A
C2550-0304SET-1	27-J0425-7S-K	N/A
C2550-0304TI	27-J0425-7T-K	N/A
C2550-0304TI-1	27-J0425-7T-K	N/A
C2550-0305	27-J0425-7S-K	N/A
C2550-0306	27-J0566-7S-K	N/A
C2550-0307ET	27-J0519-7S-K	48-260032-R1
C2550-0307ET-S2	27-J0519-7S-K	N/A
C2550-0308	27-J0563-7S-K	N/A
C2550-0308ET	27-J0563-7S-K	N/A
C2550-0309(ET)	27-J0519-7S-K	26-0309-3S-K
C2550-0309-R1C	27-J0519-7S-K	26-0309-3S-K
C2550-0310	27-J0535-7S-K	N/A
C2550-0312	27-J0425-7S-K	N/A
C2550-0313N	27-J0450-7S-K	26-0313N-7S-K
C2550-0314	27-J0425-7S-K	26-0314-7S-K
C2550-0314EP	27-J0425-7S-K	26-0314-7S-K
C2550-0314ET	27-J0425-7S-K	26-0314-7S-K
C2550-0314ET-A	27-J0425-7S-K	26-0314-7S-K
C2550-0315	27-J0425-7S-K	N/A
C2550-0315ET	27-J0425-7S-K	N/A
C2550-0316TI	N/A	26-0316-MP-KB
C2550-0316TI-1	N/A	26-0316-MP-KB
C2550-0317	27-J0CTR-7S-K	N/A
C2550-0317A	27-J0CTR-7S-K	N/A
C2550-0317B	27-J0CTR-7S-K	N/A
C2550-0317B-1	27-J0CTR-7S-K	N/A
C2550-0317B-2	27-J0CTR-7S-K	N/A
C2550-0317B-TI	27-J0CTR-7T-K	N/A
C2550-0317C	27-J0CTR-7S-K	N/A
C2550-0317C-1	27-J0CTR-7S-K	N/A
C2550-0317D	27-J0CTR-7S-K	N/A
C2550-0317D-1	27-J0CTR-7S-K	N/A
C2550-0317D-2	27-J0CTR-7S-K	N/A
C2550-0317E	27-J0CTR-7S-K	N/A
C2550-0317E-1	27-J0CTR-7S-K	N/A
C2550-0319ET	27-J0519-7S-K	N/A
C2550-0321	27-J0425-7S-K	N/A
C2550-0321-A	27-J0425-7S-K	N/A
C2550-0327A	27-J0CTR-7S-K	N/A
C2550-0344A	27-J0425-7S-K	N/A
C2550-0344A-TI	27-J0425-7T-K	N/A
C2550-0356	27-J0425-7S-K	N/A
C2550-0356ET	27-J0425-7S-K	N/A

Item #	Universal Replacement	HQ Replacement
C2550-0408ET	27-G0356-7S-K	N/A
C2550-0435	27-J0425-7S-K	26-0535-7S-K
C2550-0456	27-J0425-7S-K	26-0056-7S-K
C2550-0456-TI	27-J0425-7T-K	N/A
C2550-0503	27-J0425-7S-K	26-0517-MP-K
C2550-0503-TPS	27-J0425-7S-K	26-0517-MP-K
C2550-0517(TI)	27-J0438-7T-K	N/A
C2550-0517-Z	27-J0438-7S-K	N/A
C2550-0521(-B)	27-J0425-7S-K	N/A
C2550-0532-TI	27-J0425-7T-K	N/A
C2550-0533-PS	27-J0425-7S-K	N/A
C2550-0534	27-J0688-7S-K	N/A
C2550-0534TI	27-J0688-7T-K	N/A
C2550-0535	27-J0425-7S-K	26-0535-7S-K
C2550-0535	27-J0425-7S-K	26-50080-K
C2550-0535-01	27-J0425-7S-K	26-0535-7S-K
C2550-05351ET	27-J0425-7S-K	26-0535-7S-K
C2550-05351ET-1	27-J0425-7S-K	26-0535-7S-K
C2550-05352ET	27-J0425-7S-K	26-0535-7S-K
C2550-0535ET	27-J0425-7S-K	26-0535-7S-K
C2550-0535ET+	27-J0425-7S-K	26-0535-7S-K
C2550-0535ETT+	27-J0425-7T-K	26-0535-7T-K
C2550-0535-TI	27-J0425-7T-K	26-0535-7T-K
C2550-0535-TPS	27-J0425-7S-K	26-0535-7S-KP
C2550-0535-TPS	27-J0425-7S-K	26-0535-7S-K
C2550-0535-TT	27-J0425-7T-K	26-0535-7T-K
C2550-0535-TTS	27-J0425-7T-K	26-0535-7T-K
C2550-0536	27-J0425-7S-K	26-0535-7S-K
C2550-0537	27-J0425-7S-K	26-0535-7S-K
C2550-0537ET	27-J0425-7S-K	26-0535-7S-K
C2550-0537ET+1	27-J0425-7S-K	26-0535-7S-K
C2550-0537ET+2	27-J0425-7S-K	26-0535-7S-K
C2550-0537ET-1	27-J0425-7S-K	26-0535-7S-K
C2550-0537ET-2	27-J0425-7S-K	26-0535-7S-K
C2550-0537ET-C	27-J0425-7S-K	26-0535-7S-K
C2550-0537ETT+	27-J0425-7T-K	26-0535-7T-K
C2550-0538	27-J0425-7S-K	N/A
C2550-0538ET+	27-J0425-7S-K	N/A
C2550-0540	27-J0425-7S-K	N/A
C2550-0540ET	27-J0425-7S-K	N/A
C2550-0540NP	27-J0425-7S-K	N/A
C2550-0540-TT	27-J0425-7T-K	N/A
C2550-0556	27-J0425-7S-K	26-0556-7S-K
C2550-0601(ET/G)	27-J0568-7S-K	26-0601-7S-K
C2550-0601(G)	27-J0568-7S-K	26-0601-7S-K
C2550-0601-2	27-J0568-7S-K	26-0601-7S-K
C2550-0601ET-2	27-J0568-7S-K	26-0601-7S-K
C2550-0621	27-J0425-7S-K	N/A
C2550-0621-2	27-J0425-7S-K	N/A
C2550-0621-A	27-J0425-7S-K	N/A
C2550-0735(ET)	27-J0425-7S-K	26-0535-7S-K
C2550-07352(ET)	27-J0425-7S-K	26-0535-7S-K
C2550-07352ETB	27-J0425-7S-K	26-0535-7S-K
C2550-0735ET+	27-J0425-7S-K	26-0535-7S-K
C2550-0735ET-P	27-J0425-7S-K	26-0535-7S-KP

Heater Cross Reference Guide

Item #	Universal Replacement	HQ Replacement
C2550-0735P	27-J0425-7S-K	26-0535-7S-KP
C2550-0735P	27-J0425-7S-K	26-0535-7S-KP
C2550-0735PG	27-J0425-7S-K	26-0535-7S-KP
C2550-0735T	27-J0425-7S-K	26-0535-7S-K
C2550-0736(ET)	27-J0425-7S-K	26-0736-7S-K
C2550-0737	27-J0425-7S-K	N/A
C2550-0739(ET)	27-J0425-7S-K	26-0739-7SD-K
C2550-0739ET+	27-J0425-7S-K	26-0739-7SD-K
C2550-0739ET-1	27-J0425-7S-K	26-0739-7SD-K
C2550-0739T	27-J0425-7S-K	26-0739-7SD-K
C2550-0739-TT	27-J0425-7T-K	26-0739-7SD-K
C2550-0800(ET/G)	27-J0568-7S-K	26-0800-7S-K
C2550-0800-2	27-J0568-7S-K	26-0800-7S-K
C2550-0800-2TI	27-J0568-7T-K	26-0800-7T-K
C2550-0800-2Z	27-J0568-7T-K	26-0800-7T-K
C2550-0800A	27-J0568-7S-K	26-0800-7S-K
C2550-0800A-B	27-J0568-7S-K	26-0800-7S-K
C2550-0800A-C	27-J0568-7S-K	26-0800-7S-K
C2550-0800ET+	27-J0568-7S-K	26-0800-7S-K
C2550-0800ET-2	27-J0568-7S-K	26-0800-7S-K
C2550-0800ET-S2	27-J0568-7S-K	26-0800-7S-K
C2550-0800TT	27-J0568-7T-K	26-0800-7T-K
C2550-0801	27-J0568-7S-K	N/A
C2550-0801A	27-J0568-7S-K	N/A
C2550-0801ET	27-J0568-7S-K	N/A
C2550-0801ET+	27-J0568-7S-K	N/A
C2550-0802(ET)	27-J0568-7S-K	26-0802-7S-K
C2550-0802A	27-J0568-7S-K	26-0802-7S-K
C2550-0802A-TT	27-J0568-7S-K	26-0802-7T-K
C2550-0802ET-C	27-J0568-7S-K	26-0802-7S-K
C2550-0803	27-J0568-7S-K	N/A
C2550-0803A	27-J0568-7S-K	N/A
C2550-0804A	27-J0568-7S-K	N/A
C2550-0807	27-J0425-7S-K	26-58083-K
C2550-0807-825	27-J0425-7S-K	26-58083-K
C2550-0807-AS	27-J0425-7S-K	26-58083-K
C2550-0807-PS1	27-J0425-7S-K	26-58083-K
C2550-0807-S	27-J0425-7S-K	26-58083-K
C2550-0807-S1	27-J0425-7S-K	26-58083-K
C2550-0807-TI	27-J0425-7T-K	26-55624-K
C2550-0807-TI-A	27-J0425-7T-K	26-55624-K
C2550-0807-TITP	27-J0425-7T-K	26-55624-K
C2550-0807-TP	27-J0425-7S-K	26-55624-K
C2550-0807-TPS	27-J0425-7S-K	26-55624-K
C2550-0807-TPS1	27-J0425-7S-K	26-58083-K
C2550-0807-TPSH	27-J0425-7S-K	26-58083-K
C2550-0807-TTS	27-J0425-7T-K	26-55624-K
C2550-0807-Z	27-J0425-7S-K	26-55624-K
C2550-0807-ZTS	27-J0425-7S-K	26-55624-K
C2550-0808	27-J0425-7S-K	26-0808-7TD-K
C2550-0808-TI	27-J0425-7T-K	26-0808-7TD-K
C2550-0809	27-J0425-7S-K	26-58027-K
C2550-0809-1	27-J0425-7S-K	26-58027-K
C2550-0809-TPS	27-J0425-7S-K	26-0809-7S-KSP
C2550-0809-TPS	27-J0425-7S-K	26-58019-K

Item #	Universal Replacement	HQ Replacement
C2550-0814	27-J0425-7S-K	26-0814-7S-K
C2550-0814-HLS	27-J0425-7S-K	26-0814-7S-K
C2550-0814-TPS	27-J0425-7S-K	26-0814-7S-K
C2550-0815	27-J0425-7S-K	N/A
C2550-0835	N/A	26-58001-K
C2550-0850	27-J0438-7S-K	N/A
C2550-0850ET	27-J0438-7S-K	N/A
C2550-0850F-ET	27-J0438-7S-K	N/A
C2550-0860	27-J0438-7S-K	N/A
C2550-0860ET	27-J0438-7S-K	N/A
C2550-0861	27-F0350-7S-K	N/A
C2550-0861ET	27-F0350-7S-K	N/A
C2550-0862ET	27-G0469-7S-K	N/A
C2550-0862ET-A	27-G0469-7S-K	N/A
C2550-0867-TI	27-G0500-7T-K	N/A
C2550-0872	27-JOCTR-7S-K	N/A
C2550-1000	27-J0425-7S-K	26-1002-7S-K
C2550-1000ET	27-J0425-7S-K	26-1002-7S-K
C2550-1002(ET)	27-F0288-7S-K	26-1002-7S-K
C2550-1004	27-F0288-7S-K	26-1004-7S-K
C2550-1004-1	27-F0288-7S-K	26-1004-7S-K
C2550-1004TI	27-F0288-7T-K	26-1004-7T-K
C2550-1004TI-1	27-F0288-7T-K	26-1004-7T-K
C2550-1008ET	27-L0700-7S-K	26-1008-7S-K
C2550-1015ET	27-J0425-7S-K	N/A
C2550-1053	27-J0550-7S-K	N/A
C2550-1053-TI	27-J0550-7T-K	N/A
C2550-1054	27-JOCTR-7S-K	N/A
C2550-1054-1	27-JOCTR-7S-K	N/A
C2550-1054-2	27-JOCTR-7S-K	N/A
C2550-1054-TI	27-JOCTR-7T-K	N/A
C2550-1054-TI-1	27-JOCTR-7T-K	N/A
C2550-1056	27-J0425-7S-K	N/A
C2550-1059	27-J0575-7S-K	N/A
C2550-1206	27-G0413-7S-K	26-1206-7S-K
C2550-1206-1	27-G0413-7S-K	N/A
C2550-1206-A	27-G0413-7S-K	N/A
C2550-1206ET	27-G0413-7S-K	N/A
C2550-1207	27-G0456-7S-K	N/A
C2550-1208	27-G0456-7S-K	N/A
C2550-1226	27-J0544-7S-K	N/A
C2550-1226-1	27-J0544-7S-K	N/A
C2550-1226-1A	27-J0544-7S-K	N/A
C2550-1226-A	27-J0544-7S-K	N/A
C2550-1227	27-J0519-7S-K	26-1227-7S-K
C2550-1227-TI	27-J0519-7T-K	N/A
C2550-1322	27-J0519-7S-K	N/A
C2550-1322-B	27-J0519-7S-K	N/A
C2550-1322-TI	27-J0519-7T-K	N/A
C2550-1322-Z	27-J0519-7S-K	N/A
C2550-2001	27-J0519-7S-K	26-2001-7S-K
C2550-2300	N/A	26-2300-7S-K
C2550-2300ET	N/A	26-2300-7S-K
C2550-304SET-50	27-J0425-7S-K	N/A
C2550-307ET-S2	27-J0425-7S-K	N/A

Heater Cross Reference Guide

Item #	Universal Replacement	HQ Replacement
C2550-3600ET-G	N/A	26-3602-7S-K
C2550-3602ET	N/A	26-3602-7S-K
C2550-3660	N/A	26-C3160-1S
C2550-3661	N/A	26-C3160-1S
C2550-3661-TI	N/A	26-C3160-1S
C2550-3661-TI1	N/A	26-C3160-1S
C2550-3661-TI2	N/A	26-C3160-1S
C2550-3672	N/A	26-C3072-8T-KF
C2550-5000	27-J0425-7S-K	N/A
C2550-5000-1	27-J0425-7S-K	N/A
C2550-5000-1TI	27-J0425-7T-K	N/A
C2550-5000-1Z	27-J0425-7S-K	N/A
C2550-5000-2	27-J0425-7S-K	N/A
C2550-5000-2B	27-J0425-7S-K	N/A
C2550-5000-3	27-J0425-7S-K	N/A
C2550-5000-3TI	27-J0425-7T-K	N/A
C2550-5000-BI	27-J0425-7S-K	N/A
C2550-5000-P	27-J0425-7S-K	N/A
C2550-5002	27-J0568-7S-K	N/A
C2550-5003	27-J0568-7S-K	N/A
C2550-5004-1	27-J0425-7S-K	N/A
C2550-735P	27-J0425-7S-K	N/A
C2550-93S1-BF	27-F0CTR-7S-K	N/A
C2550-93S1-CBF	27-F0CTR-7S-K	N/A
C2550-93S1-EBF	27-F0CTR-7S-K	N/A
C2550-93S1-ECBF	27-F0CTR-7S-K	N/A
C2550-93S1-TCBF	27-F0CTR-7S-K	N/A
C2550-93S1-TIBF	27-F0CTR-7T-K	N/A
C2550-93S2-BF	27-F0CTR-7S-K	N/A
C2550-93S2-CBF	27-F0CTR-7S-K	N/A
C2550-93S2-EBF	27-F0CTR-7S-K	N/A
C2550-93S2-ECBF	27-F0CTR-7S-K	N/A
C2550-93S2-TCBF	27-F0CTR-7S-K	N/A
C2550-93S2-TIBF	27-F0CTR-7T-K	N/A
C2550-C2068-1	27-J0425-7S-K	N/A
C2550-C2684-1	27-J0425-7S-K	N/A
C2550-C2885-1	27-J0425-7S-K	N/A
C2550-C3143-1	27-J0425-7S-K	N/A
C2550-C3203-1	27-J0425-7S-K	N/A
C2550-C3452-1	27-J0425-7S-K	26-55624-K
C2550-C3452-1	27-J0425-7S-K	26-55624-K
C2550-C3452-1B	27-J0425-7S-K	26-55624-K
C2600-3117	N/A	26-H3117-8S-K
C2600-3117-TI	N/A	26-H3117-8T-K
C2700-0537-1	27-J0425-7S-K	N/A
C2720-95S1-BF	N/A	48-9130-CP-K
C2720-95S1-CBF	N/A	48-9130-CP-K
C2720-95S1-EBF	N/A	48-9130-CP-K
C2720-95S1-ECBF	N/A	48-9130-CP-K
C2720-95S1-TCBF	N/A	48-9130-CP-K
C2720-95S1-TIBF	N/A	48-9130-CP-K
C2720-95S2-BF	N/A	48-9130-CP-K
C2720-95S2-CBF	N/A	48-9130-CP-K
C2720-95S2-EBF	N/A	48-9130-CP-K
C2720-95S2-ECBF	N/A	48-9130-CP-K

Item #	Universal Replacement	HQ Replacement
C2720-95S2-TCBF	N/A	48-9130-CP-K
C2720-95S2-TIBF	N/A	48-9130-CP-K
C2783-1	N/A	26-310-U-K
C2783-1	N/A	26-301-U-KS
C3072-1	N/A	26-C3072-8T-KF
C3072-1KIT	N/A	26-C3072-8T-KF
C3072-1KITNB	N/A	26-C3072-8T-KF
C3072-1NS	N/A	26-C3072-8T-KF
C3072-1X	N/A	26-C3072-8T-KF
C3072-2	N/A	26-C3072-5T-KF
C3072-2KIT	N/A	26-C3072-5T-KF
C3072-2KITNB	N/A	26-C3072-5T-KF
C3072-2NS	N/A	26-C3072-5T-KF
C3072-2X	N/A	26-C3072-5T-KF
C3073-1	N/A	26-C3073-1T-KF
C3073-1KIT	N/A	26-C3073-1T-KF
C3073-1KITNB	N/A	26-C3073-1T-KF
C3143-S1	27-J0425-7S-K	N/A
C3160-1/S	N/A	26-C3160-1S
C3160-1KIT	N/A	26-C3160-1S
C3160-1SA	N/A	26-C3160-1S
C3160-1SKIT	N/A	26-C3160-1S
C3160-2/S	N/A	26-C3160-2S
C3160-2KIT	N/A	26-C3160-2S
C3160-2SA	N/A	26-C3160-2S
C3160-2SKIT	N/A	26-C3160-2S
C3182-1/S	N/A	26-C3182-1S
C3182-1KIT	N/A	26-C3182-1S
C3182-1SA	N/A	26-C3182-1S
C3182-1SKIT	N/A	26-C3182-1S
C3226-1	N/A	26-3226-1A-5T-K
C3226-1A	N/A	26-3226-1A-5T-K
C3226-1A-HWP	N/A	26-3226-1A-5T-K
C3226-2	N/A	26-3226-2A-BT-K
C3226-2A	N/A	26-3226-2A-BT-K
C3226-3A	N/A	26-3226-3A-7T-K
C3226-4A	N/A	26-3226-4H-ET-K
C3229-1	N/A	26-3229-2A-7T-K
C3229-1A	N/A	26-3229-2A-7T-K
C3229-2	N/A	26-3229-2A-7T-K
C3229-2A	N/A	26-3229-2A-7T-K
C3229-2A-HWP	N/A	26-3229-2A-7T-K
C3232-1A	N/A	26-3236-2A-BT-K
C3234-2A	N/A	26-3236-2A-BT-K
C3234-3A	N/A	26-3236-3A-7T-K
C3235-1A	N/A	26-3236-1A-5T-K
C3235-2A	N/A	26-3236-3A-7T-K
C3236-1A	N/A	26-3236-1A-5T-K
C3236-2A	N/A	26-3236-2A-BT-K
C3236-3A	N/A	26-3236-3A-7T-K
C3238-1A	N/A	26-C3238-1A-7T-K
C3242-1A	N/A	26-C3549-1-7T-K
C3246-2A	N/A	26-3246-2A-BT-K
C3253-1A	N/A	26-3253-1A-BT-K
C3264-2	N/A	26-3264-2-DT-K

Heater Cross Reference Guide

Item #	Universal Replacement	HQ Replacement
C3314-1	N/A	26-310-U-K
C3314-1-HWP	N/A	26-310-U-K
C3403-1	N/A	26-315-U-K
C3411-1	N/A	26-310-U-K
C3472-1A	N/A	26-3472-2H-5T-F
C3472-2	N/A	26-3472-2H-DT-F
C3472-2A	N/A	26-3472-2H-DT-F
C3473-1	N/A	26-3473-1H-5T-F
C3473-1A	N/A	26-3473-1H-5T-F
C3473-1-HWP	N/A	26-3473-1H-5T-F
C3474-1	N/A	26-3474-1H-5T-F
C3474-2	N/A	26-3474-2H-BT-K
C3475-1	N/A	26-3475-1-BT-K
C3478-1	N/A	26-3478-1A-BT-K
C3478-1A	N/A	26-3478-1A-BT-K
C3478-1A-HWP	N/A	26-3478-1A-BT-K
C3480-1	N/A	26-C3480-1-7T-K
C3482-1	N/A	28-C3482-5T-ACC
C3482-1-HWP	N/A	28-C3482-5T-ACC
C3482-2	N/A	28-C3482-DT-ACC
C3484-1	N/A	26-3484-1-BT-K
C3484-2	N/A	26-3484-2-7T-K
C3484-3	N/A	26-3484-3-5T-K
C3486-1	N/A	26-3486-1-5T-K
C3486-2	N/A	26-3486-2-7T-K
C3487-1	N/A	26-3486-1-5T-K
C3546-1	N/A	26-C3549-1-7T-K
C3547-1	N/A	26-C3548-1-7T-K
C3548-1	N/A	26-C3548-1-7T-K
C3548-1-HWP	N/A	26-C3548-1-7T-K
C3549-1	N/A	26-C3549-1-7T-K
C3550-1	N/A	26-C3550-1-7T-K
C3552-1	N/A	26-C3552-1-7T-K
C3554-1	N/A	26-C3554-1-5T-K
C3554-2	N/A	26-C3554-2-5T-K
C3554-3	N/A	26-C3554-3-5T-K
C3556-1	N/A	26-C3556-1-7T-K
C3556-2	N/A	26-C3556-2-5T-K
C3564-1	N/A	26-C3160-1S
C3564-1B	N/A	26-C3160-1S
C3564-1-HWP	N/A	26-C3160-1S
C3564-1KIT	N/A	26-C3160-1S
C3564-2	N/A	26-C3160-2S
C3564-2B	N/A	26-C3160-2S
C3564-2-HWP	N/A	26-C3160-2S
C3564-2KIT	N/A	26-C3160-2S
C3564-3	N/A	26-C3182-1S
C3564-3B	N/A	26-C3182-1S
C3564-3-HWP	N/A	26-C3182-1S
C3564-3KIT	N/A	26-C3182-1S
C3564-4	N/A	26-C3182-1S
C3564-4KIT	N/A	26-C3182-1S
C3564-5	N/A	26-C3160-2S
C3564-5KIT	N/A	26-C3160-2S
C3564-6	N/A	26-C3160-1S

Item #	Universal Replacement	HQ Replacement
C3564-6KIT	N/A	26-C3160-1S
C6746-1	N/A	26-6746-1H-5T-F
C6746-2	N/A	26-6746-2H-BT-F
C6746-3	N/A	26-6746-3H-7T-F
E2200-0001	27-V310-2T-K	N/A
E2200-0003	27-V310-2T-K	N/A
E2200-0004	27-V310-2T-K	N/A
E2200-0005-TI	27-V310-2T-K	N/A
E2200-0014	27-V310-2T-K	N/A
E2200-0015(ET)	27-V310-2T-K	N/A
E2200-0303T-1	27-V310-2T-K	N/A
E2200-0303T-2	27-V310-2T-K	N/A
E2200-0350	27-V310-2T-K	N/A
E2200-0350ET	27-V310-2T-K	N/A
E2250-0012	27-V310-2T-K	N/A
E2250-0020	27-V310-2T-K	N/A
E2250-0121	27-V310-2T-K	N/A
E2250-0127ET	27-V310-2T-K	N/A
E2250-0127ETX	27-V310-2T-K	N/A
E2250-0200ET	27-V310-2T-K	N/A
E2250-0201(ET)	27-V310-2T-K	N/A
E2250-0202(ET)	27-V310-2T-K	N/A
E2250-0202ETH	27-V310-2T-K	N/A
E2250-020X	27-V310-2T-K	N/A
E2250-020XET	27-V310-2T-K	N/A
E2250-0303T-1	27-V310-4T-K	N/A
E2270-0012	27-V310-4T-K	N/A
E2270-1000	N/A	26-303-U-KS
E2270-3314	27-V310-4T-K	N/A
E2270-6500-315	27-V310-4T-K	N/A
E2280-0300ET	27-V310-4T-K	N/A
E2280-0301ET	27-V310-4T-K	N/A
E2300-0012	27-V310-4T-K	N/A
E2300-0126ET	27-V310-4T-K	N/A
E2300-0127ET(X)	27-V310-4T-K	N/A
E2300-0300ET	27-V310-4T-K	N/A
E2300-0301ET	27-V310-4T-K	N/A
E2300-0303T-1	27-V310-4T-K	N/A
E2300-0321	27-V310-4T-K	N/A
E2300-0321ET	27-V310-4T-K	N/A
E2300-0322ET	27-V310-4T-K	N/A
E2300-0421ET	27-V310-4T-K	N/A
E2300-0542ET	27-V310-4T-K	N/A
E2360-0245	27-V310-4T-K	N/A
E2400-0001	27-V310-5T-K	N/A
E2400-0003	27-V310-5T-K	N/A
E2400-0004	27-V310-5T-K	N/A
E2400-0005-TI	27-V310-5T-K	N/A
E2400-0007	27-V310-5T-K	N/A
E2400-0012	27-V310-5T-K	N/A
E2400-0014	27-V310-5T-K	N/A
E2400-0014(ET)	27-V310-5T-K	N/A
E2400-0015	27-V310-5T-K	N/A
E2400-0015ET	27-V310-5T-K	N/A
E2400-0016	27-V310-5T-K	N/A

Heater Cross Reference Guide

Item #	Universal Replacement	HQ Replacement
E2400-0021	27-V310-5T-K	N/A
E2400-0021ET	27-V310-5T-K	N/A
E2400-0021ET-1	27-V310-5T-K	N/A
E2400-0021-NP	27-V310-5T-K	N/A
E2400-0025	27-V310-5T-K	N/A
E2400-0025-HQ	27-V310-5T-K	N/A
E2400-0026	27-V310-5T-K	N/A
E2400-0027	27-V310-5T-K	N/A
E2400-0028C	27-V310-5T-K	N/A
E2400-0101(ET)	27-V310-5T-K	N/A
E2400-0114(ET)	27-V310-5T-K	N/A
E2400-0115(ET)	27-V310-5T-K	N/A
E2400-0115ETH	27-V310-5T-K	N/A
E2400-0120C	27-V310-5T-K	N/A
E2400-0121	27-V310-5T-K	N/A
E2400-0126ET	27-V310-5T-K	N/A
E2400-0127ET(X)	27-V310-5T-K	N/A
E2400-0201(ET)	27-V310-5T-K	N/A
E2400-0202-1	27-V310-5T-K	N/A
E2400-0202ET	27-V310-5T-K	N/A
E2400-0202ET-1	27-V310-5T-K	N/A
E2400-0203(ET)	27-V310-5T-K	N/A
E2400-0204(ET)	27-V310-5T-K	N/A
E2400-0221	27-V310-5T-K	N/A
E2400-0300-1	27-V310-5T-K	N/A
E2400-0300ET	27-V310-5T-K	N/A
E2400-0300ET-JM	27-V310-5T-K	N/A
E2400-0300ETNPS	27-V310-5T-K	N/A
E2400-0300X	27-V310-5T-K	N/A
E2400-0301ET	27-V310-5T-K	N/A
E2400-0303TI-1	27-V310-5T-K	N/A
E2400-0320(ET)	27-V310-5T-K	N/A
E2400-0320ETH	27-V310-5T-K	N/A
E2400-0325	27-V310-5T-K	N/A
E2400-0325ET	27-V310-5T-K	N/A
E2400-0350	27-V310-5T-K	N/A
E2400-0350ET	27-V310-5T-K	N/A
E2400-0351(ET)	27-V310-5T-K	N/A
E2400-0420ET	27-V310-5T-K	N/A
E2400-0421ET	27-V310-5T-K	N/A
E2400-0540ET	27-V310-5T-K	N/A
E2400-1001	N/A	26-1001-5S-K
E2400-1127	27-V310-5T-K	N/A
E2400-1127ET	27-V310-5T-K	N/A
E2400-2127ET	27-V310-5T-K	N/A
E2400-5001	27-V310-5T-K	N/A
E2400-5001-A	27-V310-5T-K	N/A
E2400-5002	27-V310-5T-K	N/A
E2400-5002-1	27-V310-5T-K	N/A
E2450-0127ET/TX	27-V310-6T-K	N/A
E2450-1127ET	27-V310-6T-K	N/A
E2450-2127ET	27-V310-6T-K	N/A
E2450-3127ET	27-V310-6T-K	N/A
E2500-0025	27-V310-6T-K	N/A
E2550-0001	27-V310-7T-K	N/A

Item #	Universal Replacement	HQ Replacement
E2550-0001-1	27-V310-7T-K	N/A
E2550-0012	27-V310-7T-K	N/A
E2550-0014	27-V310-7T-K	N/A
E2550-0015	27-V310-7T-K	N/A
E2550-0015ET	27-V310-7T-K	N/A
E2550-0020	27-V310-7T-K	N/A
E2550-0020R	27-V310-7T-K	N/A
E2550-0025	27-V310-7T-K	N/A
E2550-0025-HQ	27-V310-7T-K	N/A
E2550-0028	27-V310-7T-K	N/A
E2550-0028C	27-V310-7T-K	N/A
E2550-0028CP	27-V310-7T-K	N/A
E2550-0029C	27-V310-7T-K	N/A
E2550-0101(ET)	27-V310-7T-K	N/A
E2550-0102ET	27-V310-7T-K	N/A
E2550-0114(ET)	27-V310-7T-K	N/A
E2550-0115	27-V310-7T-K	N/A
E2550-0115ET	27-V310-7T-K	N/A
E2550-0120C	27-V310-7T-K	N/A
E2550-0141ET	27-V310-7T-K	N/A
E2550-0155(ET)	27-V310-7T-K	N/A
E2550-0201ET	27-V310-7T-K	N/A
E2550-0202(ET)	27-V310-7T-K	N/A
E2550-0202-1	27-V310-7T-K	N/A
E2550-0202ET	27-V310-7T-K	N/A
E2550-0202ET-1	27-V310-7T-K	N/A
E2550-0203(ET)	27-V310-7T-K	N/A
E2550-0204(ET)	27-V310-7T-K	N/A
E2550-020X(ET)	27-V310-7T-K	N/A
E2550-020X-1	27-V310-7T-K	N/A
E2550-020XET	27-V310-7T-K	N/A
E2550-0212	27-V310-7T-K	N/A
E2550-0300-1	27-V310-7T-K	N/A
E2550-0300ET	27-V310-7T-K	N/A
E2550-0300ETNPS	27-V310-7T-K	N/A
E2550-0300T	27-V310-7T-K	N/A
E2550-0300X	27-V310-7T-K	N/A
E2550-0301ET	27-V310-7T-K	N/A
E2550-0303TI-1	27-V310-7T-K	N/A
E2550-0303TI-2	27-V310-7T-K	N/A
E2550-0320(ET)	27-V310-7T-K	N/A
E2550-0320ET+	27-V310-7T-K	N/A
E2550-0320XET+	27-V310-7T-K	N/A
E2550-0325	27-V310-7T-K	N/A
E2550-0325ET	27-V310-7T-K	N/A
E2550-0350	27-V310-7T-K	N/A
E2550-0350ET	27-V310-7T-K	N/A
E2550-0351(ET)	27-V310-7T-K	N/A
E2550-0420ET	27-V310-7T-K	N/A
E2550-0520ET	N/A	26-0520-7T-K
E2550-0520-TI	N/A	26-0520-7T-K
E2550-1000	N/A	26-301-U-KS
E2550-1000	N/A	26-301-U-KS
E2550-1000-1	N/A	26-301-U-KS
E2550-1000ET+	N/A	26-301-U-KS

Heater Cross Reference Guide

Item #	Universal Replacement	HQ Replacement
E2550-1000-HWP	N/A	26-301-U-KS
E2550-3314	N/A	26-310-U-K
E2550-5001	27-V310-7T-K	N/A
E2550-5001-A	27-V310-7T-K	N/A
E2550-5002	27-V310-7T-K	N/A
E2550-5002-1	27-V310-7T-K	N/A
E2550-6500-301	N/A	26-301-U-KS
E2550-6500-310	N/A	26-310-U-K
E2550-6500-310A	N/A	26-310-U-K
E2600-0016	27-V310-7T-K	N/A
EM100 SYSTEM HTR	27-J0425-5S-K	26-0314-5S-K
EM104 SYSTEM HTR	27-J0425-5S-K	26-0314-5S-K
EM105 SYSTEM HTR	27-J0425-5S-K	26-0314-5S-K
EM190 SYSTEM HTR	27-J0425-5S-K	26-0314-5S-K
F0001-2250	27-J0519-3S-K	N/A
F0001-2400	27-J0519-5S-K	N/A
F0001-2550	27-J0519-7S-K	N/A
F0001-2550-1	27-J0519-7S-K	N/A
F0002-2250	N/A	26-0011-7S-K
F0011-2550	27-J0519-7S-K	N/A
F0015-2550	27-J0519-7S-K	N/A
F2010-2550	27-J0425-7S-K	N/A
F2200-1001	N/A	26-1001-2S-K
F2250-0001	27-J0519-3S-K	26-0011-3S-K
F2250-0011	27-J0519-3S-K	26-0011-3S-K
F2250-2001	27-J0519-3S-K	26-2001-7S-K
F2250-2001-1	27-J0519-3S-K	26-2001-7S-K
F2400-0011	27-J0519-5S-K	26-0011-5S-K
F2400-1001	N/A	26-1001-5S-K
F2550-0001	N/A	26-0011-7S-K
F2550-0011-100	27-J0519-7S-K	N/A
F2550-0011-101	27-J0519-7S-K	N/A
F2550-0015	N/A	26-0011-7S-K
F2550-2001	27-J0519-7S-K	26-2001-7S-K
F2550-2001-1	27-J0519-7S-K	26-2001-7S-K
F2550-2010	N/A	26-0011-7S-K
F2550-4002	N/A	26-C3554-3-5T-K
G7410	27-J0425-5S-K	26-58104-K
G7412	27-J0425-5S-K	26-58104-K
G7414	N/A	26-58203-K
G7415	27-J0425-5S-K	26-58031-K
G7416	27-J0425-5S-K	26-0535-5S-KP01
G7418	27-J0425-5S-K	26-58048-K
G7430	27-J0425-5S-K	26-55625-K
G7432	27-J0425-5T-K	26-55625-K
G7510	27-J0425-7S-K	26-58083-K
G7512	27-J0425-7S-K	26-58083-K
G7518	27-J0425-5S-K	26-58083-K
G7530	27-J0425-7T-K	26-55624-K
G7532	27-J0425-7T-K	26-55624-K
HEA14100001	27-J0413-7S-K	N/A
HEA14100010	27-K0550-3T-K	26-0165-3S-K
HEA14100120	27-J0413-7S-K	N/A
HEA14100121	N/A	26-0011-7S-K
HEA14100131	N/A	26-0011-F-PS-K

Item #	Universal Replacement	HQ Replacement
HEA14100300	N/A	26-0011-F-RS-K
HEA14100401	N/A	26-0011-7S-K
HEA14100430	27-J0519-7S-K	26-2001-7S-K
HEA14100470	N/A	26-0011-F-RS-K
HTR6500301	N/A	26-301-U-KS
IHH-4000-NHCW-6758	N/A	26-C3160-2S
IHH-4300-NHW-7340	N/A	26-3473-1-5T-K
IHH-6000-NHCW-6759	N/A	26-C3160-1S
IHH-6000-NHCW-7211	N/A	26-C3160-1S
LX-10	27-F0313-5S-K	26-1002-5S-K-T
LX-15	27-J0425-5S-K	26-0056-5S-K
MRQ740-0584	27-F0475-5S-K	26-C2278-1-5S-K
NHH-5500-NH-7328	N/A	26-C3550-1-7T-K
PEH-4326-NHW-6000	N/A	26-C3556-1-7T-K
PEH5526-NH-6340	N/A	26-C3556-2-5T-K
PEH-5526-NH-6742	N/A	26-C3556-2-5T-K
PEH-5526-NHW-6388	N/A	26-C3556-1-7T-K
PEH-5526-NHW-6938	N/A	26-3236-1A-5T-K
PEH-5556-NHW-6388	N/A	26-C3556-2-5T-K
SD6500-301	N/A	26-301-U-KS
SEH-2700-NHC	N/A	26-3478-1A-BT-K
SEH-4100-NHCW-7130	N/A	26-3236-1A-5T-K
SEH-4300-NHCW-6699	N/A	26-3226-1A-5T-K
SEH-4300-NHW-6595	N/A	26-3473-1-5T-K
SEH-5200-NH-6757	N/A	26-C3548-1-7T-F
SEH-5200-NH-6757	N/A	26-C3548-1-7T-K
SEH-5500-NH	N/A	26-C3548-1-7T-F
SEH-5500-NH	N/A	26-C3548-1-7T-K
SEH-5500-NH-6143	N/A	26-C3548-1-7T-F
SEH-5500-NH-6143	N/A	26-C3548-1-7T-K
SEH-5500-NH-6144	N/A	26-C3548-1-7T-F
SEH-5500-NH-6144	N/A	26-C3548-1-7T-K
SEH-5500-NH-6698	N/A	26-3229-2A-7T-K
SEH-5500-NH-6699	N/A	26-3229-2A-7T-K
SEH-5500-NHC-6632	N/A	26-3236-1A-5T-K
SEH-5500-NHC-6699	N/A	26-3229-2A-7T-K
SEH-5500-NHC-7300	N/A	26-C3548-1-7T-F
SEH-5500-NHC-7300	N/A	26-C3548-1-7T-K
SEH-5500-NHCW-6938	N/A	26-3238-1H-7T-K
SEH-5500-NHW-6652	N/A	26-3236-1A-5T-K
SEH-5500-NHW-6676	N/A	26-3236-1A-5T-K
SEH-5500-NHW-7007	N/A	26-3236-1A-5T-K
SEH550-NHC-7300	N/A	26-C3548-1-7T-K
SEH-550-NHW-6692	N/A	26-3236-1A-5T-K
SHH-5200-NH-6785	N/A	26-C3550-1-7T-K
SHH-5500-NH-6727	N/A	26-C3549-1-7T-K
SHH-5500-NH-6739	N/A	26-3236-1A-5T-K
SHH-5500-NH-6771	N/A	26-C3550-1-7T-K
SHH-5500-NH-6871	N/A	26-C3550-1-7T-K
VIT411092	27-L0700-6S-K	26-1008-6S-K
XL5.5	27-J0413-7S-K	26-0011-7S-K

Why choose Hydro-Quip? Here's why ...

Warranty & Customer Service

At Hydro-Quip, our most vital asset is our customers. We strive to ensure that the needs of our customers are being met. Not only do we have a knowledgeable technical staff, we also offer warranty on all our products

Wide Selection of Heater Assemblies

Our HQ generic heater series offers replacements for Therm Products, Balboa, Gecko and many more. We also produce the Universal Rite-Fit heater series that will replace 100's of different heater assemblies in the field.

Replacement Parts

Many of the parts in this catalog are most likely familiar although you may not have had a good dependable source to purchase them from until now. Whether you are looking for electro-mechanical or solid state replacement parts, you will find many of top sellers in this catalog.

Balboa® Retrofit Kits

Hydro-Quip is now offering Balboa Retrofit Kits which includes VS and BP Series Systems. With our extensive list of Balboa replacement parts it makes us a dependable source for Balboa replacement products.

Retro-Fit Slide Controls

Hydro-Quip Continues to offer the broadest selection of retro-fit controls and equipment to fit all of your spa or hot tub needs. The "Slide" heater feature allows for a flexible fit heater to get your job completed in a quick and efficient manner.

UL Listed Outdoor Equipment System

Our UL Listed Equipment Systems are available as 5.5 or 11KW electric and gas ready are now WiFi capable. This system is perfect for customers who are operating their spa independently, our 8000 series brings all the features necessary for a stand alone state of the art hot tub or spa installation.

Integrated Ozone Generator

By integrating the Ozone Generator into our Spa products we now have the Ozonator interlocked to operate automatically when the power is on. An integrated Ozone generator also eliminates an "extra" component (or two) to be mounted under the spa.

Global Connectivity

Hydro-Quip is now offering a new line of Wi-Fi Enabled Systems. This feature gives you the capability of running your spa or hot tub using a smartphone or tablet.

THE DISTRIBUTOR'S CHOICE IN THE LEISURE WATER INDUSTRY.

copyright 2023 HydroQuip.JL



510A N. Sheridan St.
Corona, CA 92878
Tel: 951.273.7575
HydroQuip.com