



# HYDROQUIP™

Premier providers of quality retrofit control systems

## SPA PARTS CATALOG





# HYDROQUIP™

THE **SMART CHOICE**™

## Your Resource Solution For Replacement Spa Parts

HydroQuip is the nation's oldest manufacturer of Portable Spa Equipment which includes controls that integrate Balboa®, Gecko and Pneumatic.

Our most recent addition has been the Laing and Therm heater products. HydroQuip's goal is to stock and provide an extensive selection of quality spa parts to the North American and European OEM & Distribution networks.

As a manufacturer and master distributor our goal is to be the preferred value added supplier of replacement spa parts, spa controls & equipment, baptistry controls, spa heater elements and heater assemblies, and the support services including technical and warranty assistance on all brands we offer including:

- **Balboa®** – Spa Controls, PC Boards, Spasides & Overlays, Heaters, Sensors, Wet Ends, Hot tub Jets and Fittings
- **Gecko** – Spa Controls, PC Boards, Spasides, Overlays, Heaters, Sensors, Etc.
- **Grundfos** – Spa Circulation Pumps
- **Laing** – E-3, E-5, E-10 and E-14 Circulation Pumps and Heaters
- **Therm Products** – Spa Heater Elements and Heater Assemblies
- **Related Metal Fabrication (RMF)** – Spa Heater Elements and Heater Assemblies
- **Truheat** – Spa Heater Elements and Heater Assemblies
- **Tecmark** – Pressure & Vacuum Switches, Air switches, Spaside Controls
- **Aquatemp** - Spa Heater Elements and Heater Assemblies





## About us:

### HydroQuip ... the Smart Choice

HydroQuip has been providing innovative, dependable and high quality portable spa and hot tub retrofit controls to the industry for over 30 years. HydroQuip continues to offer the broadest selection of controls and replacement parts to fit every spa or hot tub. We continue to lead the industry in innovation and “down to earth” product features by designing products that address the real needs and desires of today’s spa and hot tub retail dealers and service technicians.

“Down to Earth” features such as this long list of industry firsts:

<b><u>Electronic Controls</u></b>	Choice of Balboa® or Gecko Series
<b><u>Slide Heater Assembly</u></b>	Position the heater to your requirements
<b><u>Versi-Heat Remote Heaters</u></b>	Remote heater for added convenience
<b><u>Universal Retro-Fit System</u></b>	Complete ready to install bundled Control Kits
<b><u>Visual Diagnostic System</u></b>	Provides easy system diagnostics
<b><u>System Mis-Wire Protection</u></b>	Protection from improper electrical installations
<b><u>Universal Circuit Voltages</u></b>	Flexible circuit designs

In addition to our innovative spa and hot tub products, you will find our customer service team to be unmatched in their first hand product knowledge. Our customer service, sales and technical support teams are all industry veterans that understand not only the product but the application spa customers encounter on a daily basis. We take great pride in our reputation for superior quality and responsive customer service, all at a competitive price.

**In the following pages you will find a selection of products and replacement parts which address your new and retro-fit needs and marketing requirements. Please contact us if you have any additional needs, questions or requirements.**

## PARTS AND ACCESSORIES

	<i>Page</i>
Relays & Contactors.....	8.1
Heater Elements.....	8.2-8.3
Pressure & Flow Switches.....	8.4
Thermostats, High-Limits & Timers .....	8.5
Printed Circuit Boards .....	8.6-8.8
Spasides & Accessories.....	8.9-8.19
Switches & Transmitters.....	8.19
High-Limit & Temperature Sensors .....	8.20-8.21
GFCI'S, Transformers .....	8.21
Hardware.....	8.22-23
Terminal Blocks & Fuses.....	8.24
PVC Fittings & Parts .....	8.25-8.27
Pumps / Wet Ends / Parts .....	8.28-8.34
Heater Assemblies / Heater Replacements.....	8.35-8.51
Cords and Receptacles.....	8.52
Baptismal Replacement Parts.....	8.53-8.55

## CROSS REFERENCE

	<i>Page</i>
Balboa to HydroQuip Cross Reference .....	9.1-9.2
Heater Assembly Cross Reference.....	9.3-9.8
Heater Element Cross Reference.....	9.9
Laing & Grundfos Pumps Cross Reference .....	9.10-9.11

## INFORMATION

	<i>Page</i>
Index .....	10.1-10.8



PT# 35-0002-K



PT# 35-0003-K



PT# 35-0012-K

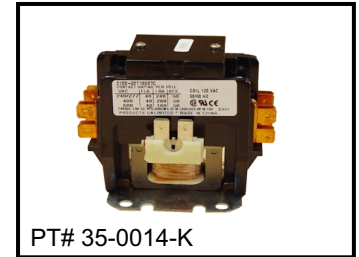

PT# 35-0014-K



PT# 35-0025-K



PT# 35-0026-K

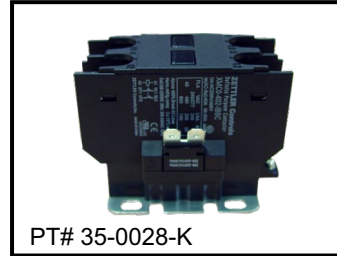

PT# 35-0028-K



PT# 35-0031A & 35-0031-K



PT# 35-0036-K



PT# 35-0037-K



PT# 35-0077-K



PT# 35-0078-K

Parts

PART NUMBER	DESCRIPTION
35-0002-K	Relay, SPDT, 120V,15A, T-91
35-0003-K	Relay, SPDT, 240V, 15A, T-91
35-0012-K	Contactors, DPST, 120V, 30/40A
35-0014-K	Contactors, DPST, 120V, 50A
35-0025-K	Contactors, SPST, 120V, 30A
35-0026-K	Contactors, SPST, 240V, 30A
35-0028-K	Contactors, DPST, 240V, 40/50A
35-0031-K	Relay, DPDT, 240V, 10A
35-0031A	Base, Relay Mounting, SE
35-0036-K	Relay, DPST, 120V, 30A, T-92
35-0037-K	Relay, DPDT, 240V, 30A, T-92
35-0077-K	Relay, DPDT, 120V, 30A, T-92
35-0078-K	Relay, DPDT, 240VAC, 10A, Baptisml

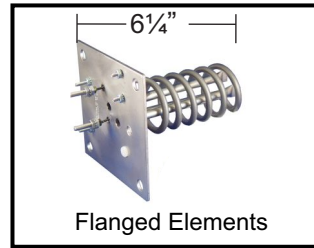
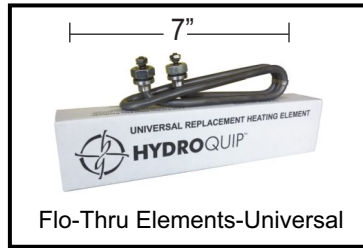
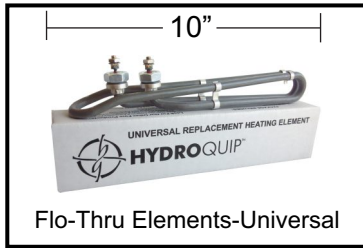

Each Heater Element Includes Hardware Kit

All universal heater elements are individually boxed to keep the element clean and protect the terminals from being damaged prior to use. A color coded packing label is used on all universal element boxes to quickly & easily identify heater wattage.

Universal Flo-Thru elements are available individually boxed or as a 24 unit Master Pack shown above.

<b>INCOLOY PT#</b>	<b>TITANIUM PT#</b>	<b>DESCRIPTION</b>
12-0100-K	12-0100F-K	5.5KW, 240V, 10"
12-0101-K	12-0101F-K	4.5KW, 240V, 10"
12-0102-K	12-0102F-K	4.0KW, 240V, 10"
12-0104-K	12-0104F-K	3.0KW, 240V, 10"
12-0105-K	12-0105F-K	2.5KW, 240V, 10"
12-0106-K	12-0106F-K	2.0KW, 240V, 10"
12-0107-K	N/A	1.3KW, 240V, 10"
N/A	12-0110G-K	5.5KW, 240V, 7"
N/A	12-0111F-K	4.5KW, 240V, 7"
N/A	12-0112F-K	4.0KW, 240V, 7"
N/A	12-0113G-K	3.6KW, 240V, 7"
N/A	12-0114F-K	3.0KW, 240V, 7"
N/A	12-0116F-K	2.0KW, 240V, 7"
N/A	12-0118FF	1.5KW, 240V, 7"
12-0010-K	N/A	4.5KW, 240V, 5"x 5" Plate, 6"
12-0010A-K	N/A	5.5KW, 240V, 5"x 5" Plate, 6"

PARTS

### HQ HEATER ELEMENT DETAILS

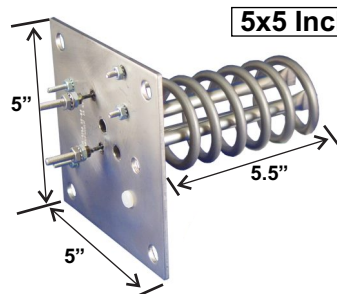
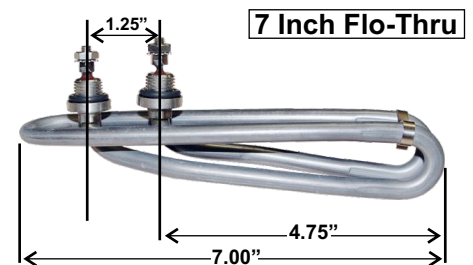
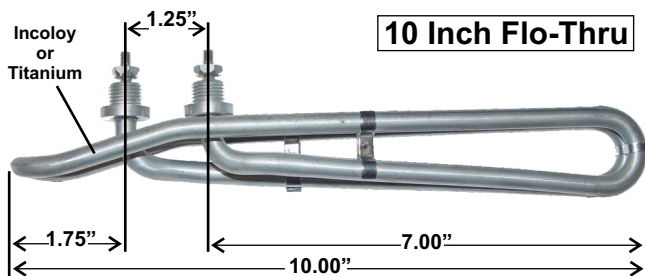

**For Flo-Thru:**

Individual Box Dimensions: 10.75"W x 2.25"H x 1.75"D  
Individual Box Weight: .75 lbs.

24 Master Pack Dimensions: 26"W x 20"H x 11"D  
24 Master Pack Weight: 18.75 lbs.

**Conversion Formula = Divide Watts by 4 (IE: 5.5kw x 1000 = 5500watts/4 = 1375watts @ 120V)**

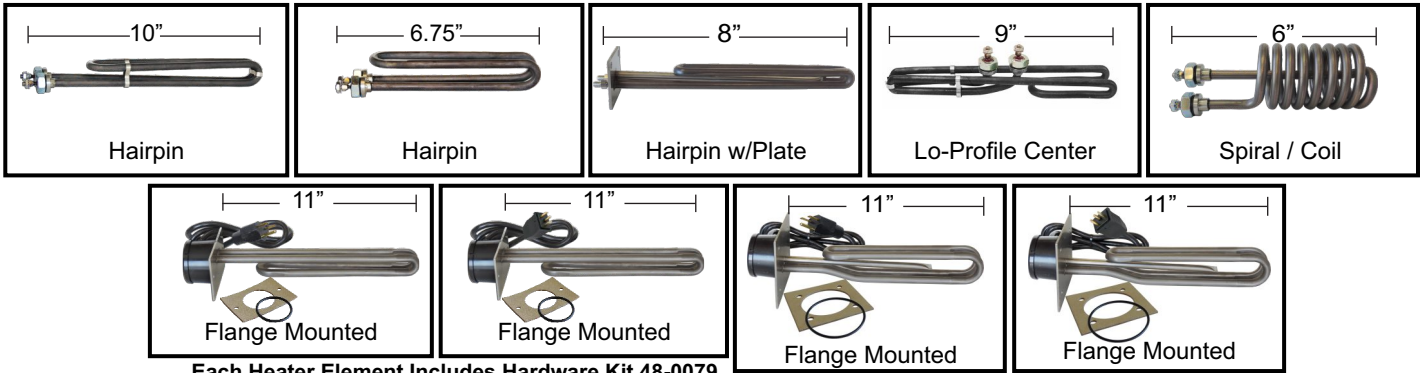

Each Heater Element Includes Hardware Kit 48-0079

INCOLOY PT#	TITANIUM PT#	DESCRIPTION
12-0300-K	N/A	5.5KW, 240V, 10", Hairpin, w/ Hardware
12-0302-K	N/A	4.0KW, 240V, 10", Hairpin, w/ Hardware
12-0303A-K	N/A	3.6KW, 240V, 6.75", Hairpin, w/ Hardware
N/A	12-0307F-K	2.0KW, 240V, 8", Full Back, w/ Hardware
N/A	12-0308F-K	2.5KW, 240V, 8", Full Back, w/ Hardware
N/A	12-0309F-K	3.0KW, 240V, 8", Full Back, w/ Hardware
12-0500-K	N/A	5.5KW, 240V, 9", Center, w/ Hardware
12-0502-K	N/A	4.0KW, 240V, 9", Center, w/ Hardware
12-0504-K	N/A	3.0KW, 240V, 9", Center, w/ Hardware
N/A	12-0600F-K	5.5KW, 240V, 6", Spiral / Coil, w/ Hardware
N/A	12-0601F-K	4.5KW, 240V, 6", Spiral / Coil, w/ Hardware
N/A	12-0602F-K	4.0KW, 240V, 6", Spiral / Coil, w/ Hardware
N/A	12-0604F-K	3.0KW, 240V, 6", Spiral / Coil, w/ Hardware
N/A	12-0606F-K	2.0KW, 240V, 6", Spiral / Coil, w/ Hardware
12-1463-AC-K	N/A	2.5KW, 240V, 2.5" x 4" Plate, w/ Nema 36" Cord
12-1463-BC-K	N/A	2.5KW, 240V, 2.5" x 4" Plate, w/ Molded 30" Cord
12-1464-AC-K	N/A	1.5KW, 120V, 4" x 4" Plate, w/ Nema 36" Cord
12-1464-BC-K	N/A	1.5KW, 120V, 4" x 4" Plate, w/ Molded 30" Cord

Parts

### HQ HEATER ELEMENT DETAILS

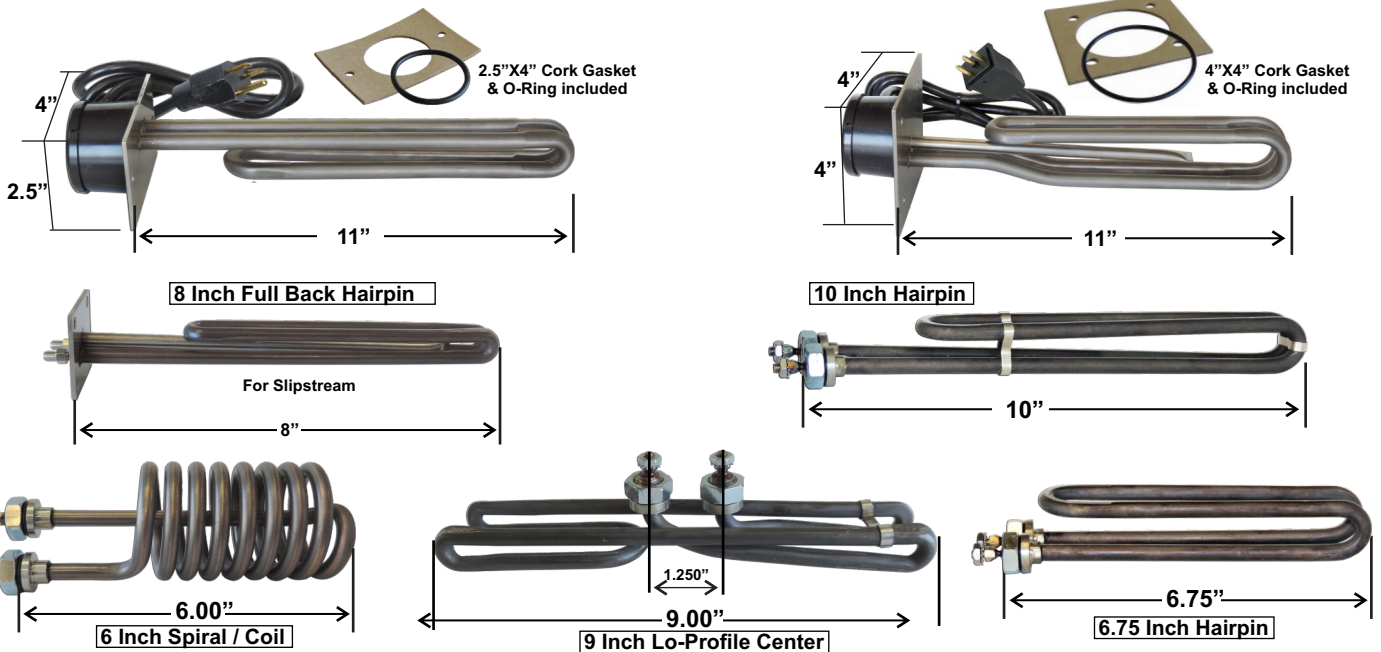

Conversion Formula = Divide Watts by 4 (IE: 5.5kw x 1000 = 5500watts/4 = 1375watts @ 120V)



## PART NUMBER

## DESCRIPTION

34-0153-K	Pressure Switch, 120V, 3A, 1/8" thread 2PSI (adjustable) Manf.# 3158-EN
34-30379	Pressure Switch, Guard for PT# 34-0153-K
34-0178-K	Pressure Switch, 120V, 1A, 1/8" thread 1.50PSI (adjustable) Manf.# 3903-EECS
34-0178B-K	Pressure Switch, 120V, 1A, 1/8" thread 1.75PSI (adjustable) Manf.# 3903-EMCS
34-0178A-K	Pressure Switch, 125/250V, 1A, 1/8" thread 2.0 PSI (adjustable)
34-0148A-K	Pressure Switch, 125V, 15.1A, 1/8" thread 2.5PSI ( not adjustable)
34-0019-C-K	Pressure Switch, 240V, 25A, 1/8" thread (adjustable) Manf.# 4010P replaces 3010P
34-0069C-K	Vacuum Switch, 125V, 12.5A, 1/8" thread (not adjustable)
34-0217-K	Flow Switch, 30V, 1A, 6' Cord, X=0.50" NPT, Y= 1.4"
34-0221-K	Flow Switch, 30V, 1A, 3/4" Barb size
34-0221A-K	Flow Switch, 30V, 1A, 4' Cord, X= 0.75" NPT, Y= 1.1"
34-0221B-K	Flow Switch, 30V, 1A, 3/4" x 1/2" Barb-Slip
48-0120*	Flow Switch Kit, 30V, 1A, 6' Cord 2"X2" W/1.5" Reducers
48-0120B	Flow Switch Kit, Air, 30V, 1A, 6' Cord 2"X2" W/1.5" Reducers
48-0223A	Flow Switch, 30V, 1A, 2" PVC Tee, AMP Plug (Not Shown)
48-0223B-K	Flow Switch, 30V, 1A, 3/4" Barb size, Molded Plug (Not Shown)
48-0223C	Flow Switch, 30V, 1A, 3/4" Barb size, MP/U/W, PCB Connect
34-0199F-K	Harness, PSI, SS, 14"
42-0013-K	Adapter, Barb, 3/4" X 1", PVC

\* Used w/series: 4100, 4200, 4220, 4230, 4330, 6100, 6200, 6220, 6230, 6330, 7100, 7500, 9700





PT# 34-0081-K

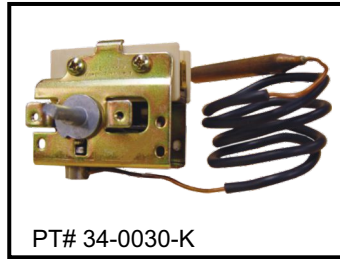

PT# 34-0030-K



PT# 48-0013

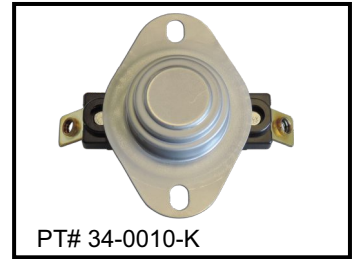

PT# 34-0010-K



PT# 34-0012-K



PT# 34-0012A-K

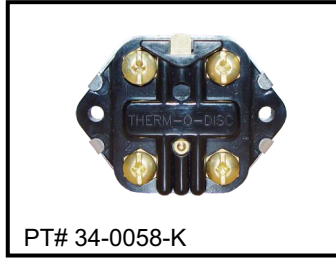

PT# 34-0058-K



PT# 48-0092S

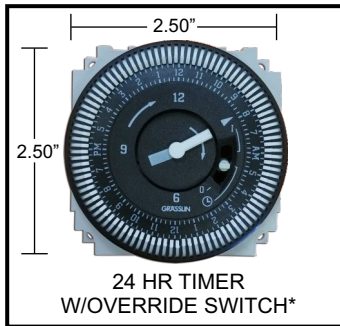

24 HR TIMER  
W/OVERRIDE SWITCH\*

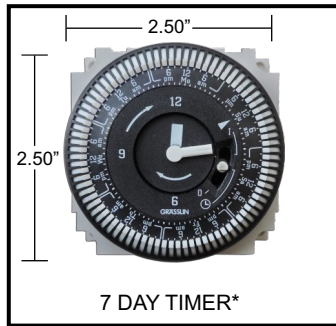

7 DAY TIMER\*

*Timer replaces all similar old style Timers of this dimension*

**Parts**

PART NUMBER	DESCRIPTION
34-0081-K	Thermostat, 120V, 1A, Solid State (TDI), 1/4" Bulb, 36" CAP
34-0081B-K	Thermostat, 120V, 1A, Solid State (TDI), 1/4" Bulb, 72" CAP (Not Shown)
34-0081C-K	Thermostat, 120V, 1A, Solid State (TDI), 3/8" Bulb, 10" CAP (Not Shown)
34-0030-K	Thermostat, 5/16 Bulb, 24" CAP
48-0013	Thermostat Knob, Univ.
34-0010-K	High Limit, TCO, Auto, 130F
34-0012-K	High Limit, 5/16 Bulb, 24" CAP
34-0012A-K	High Limit, 1/4" Bulb, 36" CAP
34-0058-K	High Limit, Thermodisc, 250V, 50A
48-0092S	High Limit, with Auto Reset, Complete Kit
34-0035-K	Timer, 7 Day, 120V, 60HZ, 21A, STD
34-0036-K	Timer, 7 Day, 240V, 60HZ, STD
34-0033-K	Timer, 24HR, 120V, 60HZ, 21A, w/Override Switch
34-0052A-K	Timer, 24HR, 240V, 50 HZ, 21A, STD, w/Override Switch
34-0049-K	Timer, 24HR, 240V, 60HZ, STD, w/Override Switch

\*Replaces Diehl/Grasslin & Other Spa Control Timers

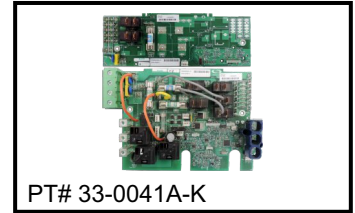
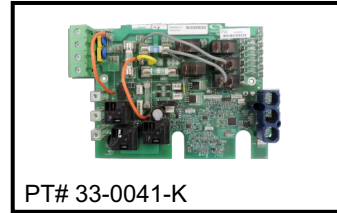
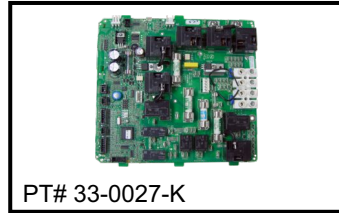
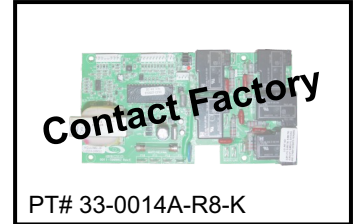
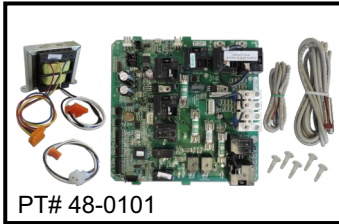

## PART NUMBER

## DESCRIPTION

33-0010-R8-K	Replaced by PT# 33-0025A-K	
33-0010-R1-5	<b>Obsolete, Replaced by PT# 48-0101</b>	
33-0012-K	<b>Obsolete - Contact Factory</b>	
33-0012A-K	<b>Obsolete - Contact Factory</b>	
33-0014A-R8-K	<b>Obsolete - Contact Factory</b>	
33-0018-R6	<b>Obsolete, Replaced by PT# 48-0101</b>	
33-0024-K Compatible With:	DIG. ECO-2, 120V (4200, 6200, 9200 series) Temp Sensor: 34-0203D Hi-Limit: 34-0201D**	Spasides: 34-0208, 34-0200, 34-0198A
33-0024A-K Compatible With:	DIG. ECO-2, 240V (4200, 6200, 9200 3 wire) Temp Sensor: 34-0203D Hi-Limit: 34-0201D**	Spasides: 34-0208, 34-0200, 34-0198A
33-0024B-K Compatible With:	DIG. ECO-3, 120V (4230, 6230, 9230 series) Temp Sensor: 34-0203D Hi-Limit: 34-0201D**	Spasides: 34-0197
33-0024C-K Compatible With:	DIG. ECO-3, 240V (4230, 6230, 9230 series - 3 wire) Temp Sensor: 34-0203D Hi-Limit: 34-0201D**	Spasides: 34-0197
33-0024D-K Compatible With:	DIG. ECO-2+2 120V (4220, 6220, 9220 series) Temp Sensor: 34-0203D Hi-Limit: 34-0201D**	Spasides: 34-0208, 34-0200, 34-0198A
33-0024E-K Compatible With:	DIG. Stand./SSPA 120V (4330, 6330, 9330 series) Temp Sensor: 34-0203D Hi-Limit: 34-0201D**	Spasides: 34-0197
33-0024F-K Compatible With:	DIG. Stand./SSPA, 240V (4330, 6330, 9330 series - 3 wire) Temp Sensor: 34-0203D Hi-Limit: 34-0201D**	Spasides: 34-0197
33-0025A-K Compatible With:	DIG. MP, Univ, 10-Key (9700 series) Temp Sensor: 34-0203D Hi-Limit: 34-0201D**	Spasides: 34-0190, 34-0190A
33-0027-K Compatible With:	DIG. MP, Outdoor 8-Key (8000 series) Temp Sensor: 34-0203D Hi-Limit: 34-0201D**	Spasides: 34-0189
48-0101 Compatible With:	Kit, MSPA to MP Conversion (replaces 33-0018-RX, 33-0010-R5 & prior) Temp Sensor: 34-0203D Hi-Limit: 34-0201D**	Spasides: 34-0190, 34-0190A
33-0041A-K Compatible With:	DIG. Y Series, ye-5	Spasides: 34-0211
33-0045A-K Compatible With:	DIG, Y Series, yt-7	Spasides: 34-0235

\*PC Boards appear physically identical. Only difference is software and/or transformer.

\*\* Sensors available in various sizes & lengths, please see page 8.20



PT# 33-53834-K



PT# 33-54115-K



PT# 33-54369-K

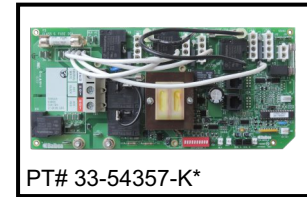

PT# 33-54357-K\*



PT# 33-56488-K



PT# 33-56965-K



PT# 33-56961-K

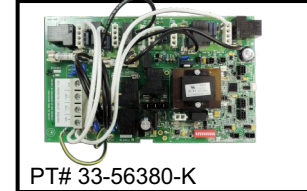

PT# 33-56380-K

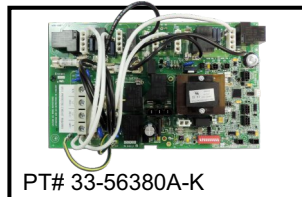

PT# 33-56380A-K

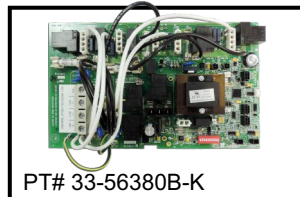

PT# 33-56380B-K

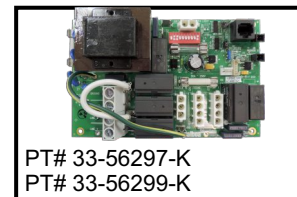

PT# 33-56297-K  
PT# 33-56299-K

Parts

OLD PRT#	NEW PRT#	DESCRIPTION
33-0029-K	33-53834-K	DIG. EL2000 (8000B series) BWG# 53834-05, Chip# EL2000M3R2E
33-0031-K	33-54115-K	Lite Leader (7100B series) BWG# 54115, Chip# LITELDR1A
33-0032-K	33-54646-K*	Duplex, VS300Z (6100B series) BWG# 54646-01, Chip# VS300FHX
33-0032A-K	33-54369-K	Duplex, VS500Z (4100B, 6100B series) BWG# 54369-03, Chip# VS500ZR2D
33-0032B-K	33-54357-K*	Duplex, VS501Z (4200B, 6200B series) BWG# 54357-03, Chip# VS501ZR2D
33-0032C-K	33-54383-K*	Duplex, VS511Z (4220B, 6220B series) BWG# 54383-04, Chip# VS511ZR2E
33-0032D-K	33-55840-K*	Duplex, VS513Z (4230B, 6230B series) BWG# 55840-01, Chip# VS513ZR1B
33-0032E-K	33-55602-K*	Duplex, VS520Z (6330B series) BWG# 55602, Chip# VS520ZR1A
33-0033-K	33-54372-K*	Serial, VS510SZ (4230B, 6230B series) BWG# 54372-03, Chip# VS510ZR2D
33-0033A-K	33-54385-K*	Serial, VS511SZ (4220B, 6220B series) BWG# 54385-03, Chip# VS511SZR2D
33-0033B-K	33-55151-K*	Serial, VS520SZ (4330B, 6330B series) BWG# 55151-01, Chip# VS520SZR1B
33-0033C-K	33-55299-K*	Serial, VS520SZ-3W (6330B-3W series) BWG# 55299-01, Chip# BDV520SZR1A
N/A	33-55152-K	Deluxe, VS520DZ, BWG# 55152-01, Chip# VS520D2R1B
33-0040-K	33-56488-K	BP, BP501-G1 (6200BP, 6230BP series) BWG# 56488-02, Chip# BP501G1R1B
33-0040A-K	33-56483-K	Obsolete, Replaced by PT# 33-56965-K
33-0040B-K	33-56585-K	Obsolete, Replaced by PT# 33-56961-K
N/A	33-56965-K	BP, BP501-G2 (6200BP, 6230BP series) BWG# 56483, Chip# BP501G2R1B
N/A	33-56961-K	BP, BP501-G3 (6200BP, 6230BP series) BWG# 56585, Chip# BP501G3R1A
N/A	33-56380-K	BP, BP2000-G1, BWG# 56380-02, Chip# BP2000G1R1C
N/A	33-56380A-K	BP, BP2000-G1 (8800 series) 208V BWG# 56380-02, Chip# BP2000G1R1C
N/A	33-56380B-K	BP, BP2000-G1 (8800 series) 240V BWG# 56380-02, Chip# BP2000G1R1C
N/A	33-56297-K	VS100, 120V, BWG# 56297
N/A	33-56299-K	VS100, 240V, BWG# 56299

Contact HydroQuip for information on which sensors and spades are compatible.

\* PC Boards may appear physically identical. Only difference may be software and/or transformer.

\*\* Sensors available in various sizes & lengths, please see page 8.20

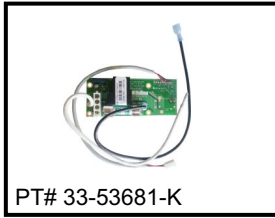

PT# 33-53681-K

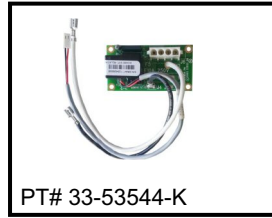

PT# 33-53544-K

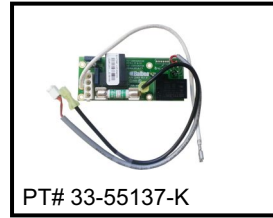

PT# 33-55137-K



PT# 33-53426-K

**Expander Boards**

<b>OLD PRT#</b>	<b>NEW PRT#</b>	<b>DESCRIPTION</b>
33-0029A-K	33-53681-K	VS/EL, Expander, 30A Fuse (6230B, 8700 series) BWG# 53681
33-0029B-K	33-53544-K	VS/EL, Expander, No Fuse (6200B series) BWG# 53544
33-0029C-K	33-55137-K	VS/EL, Expander, Dual RLY (6330B series) BWG# 55137
33-0029D-K	33-53426-K	VS/EL, Expander, 2 Receptacles (6220B series) BWG# 53426



PT# 33-52213-K

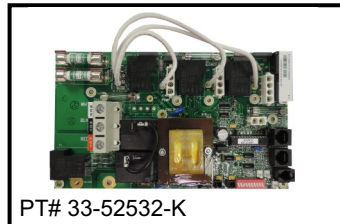

PT# 33-52532-K

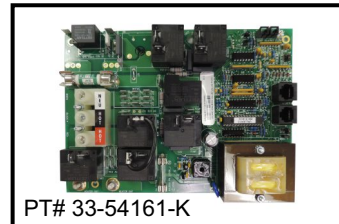

PT# 33-54161-K



PT# 33-54091-K



PT# 33-51230-K

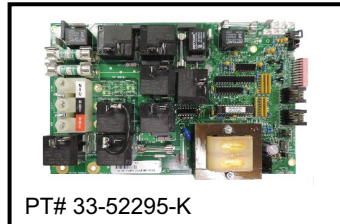

PT# 33-52295-K



PT# 33-52320-K



PT# 33-54122-K

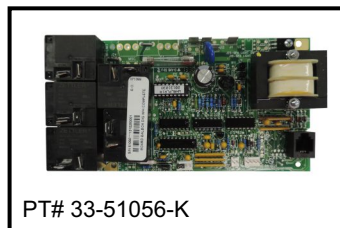

PT# 33-51056-K



PT# 33-54446-K

<b>PART NUMBER</b>	<b>DESCRIPTION</b>
33-52213-K	Balboa®, Jacuzzi Whirlpool Value System, BWG# 52213, Chip# R576R1D
33-52532-K	Balboa®, SUV, M7, BWG# 52532-02, Chip# SUVR1B
33-54161-K	Balboa®, Value Digital, BWG# 54161, Chip# VALUER1D
33-54091-K	Balboa®, Super Duplex Digital, M1 Systems, BWG# 54091, Chip# M1R1B
33-51230-K	Balboa®, Duplex Analog, BWG# 51230, Chip# DUPLER1A
33-52295-K	Balboa®, 2000LE Digital, BWG# 52295-01, Chip# 2000LER1E
33-52320-K	Balboa®, 2000M7, Serial Standard LE, BWG# 52320-01, Chip# 2000M7R1B
33-54122-K	Balboa®, Millennium Standard/Deluxe, BWG# 54122, Chip# M2/M3R1D
33-51056-K	PCB, Balboa®, Lite Digital, BWG# 51056, Chip# WHRLPLR1A
33-54446-K	PCB, Balboa®, Lite Leader, ICON15, BWG# 54446, Chip#ICON15R2B

Contact HydroQuip for information on which sensors and spasides are compatible.







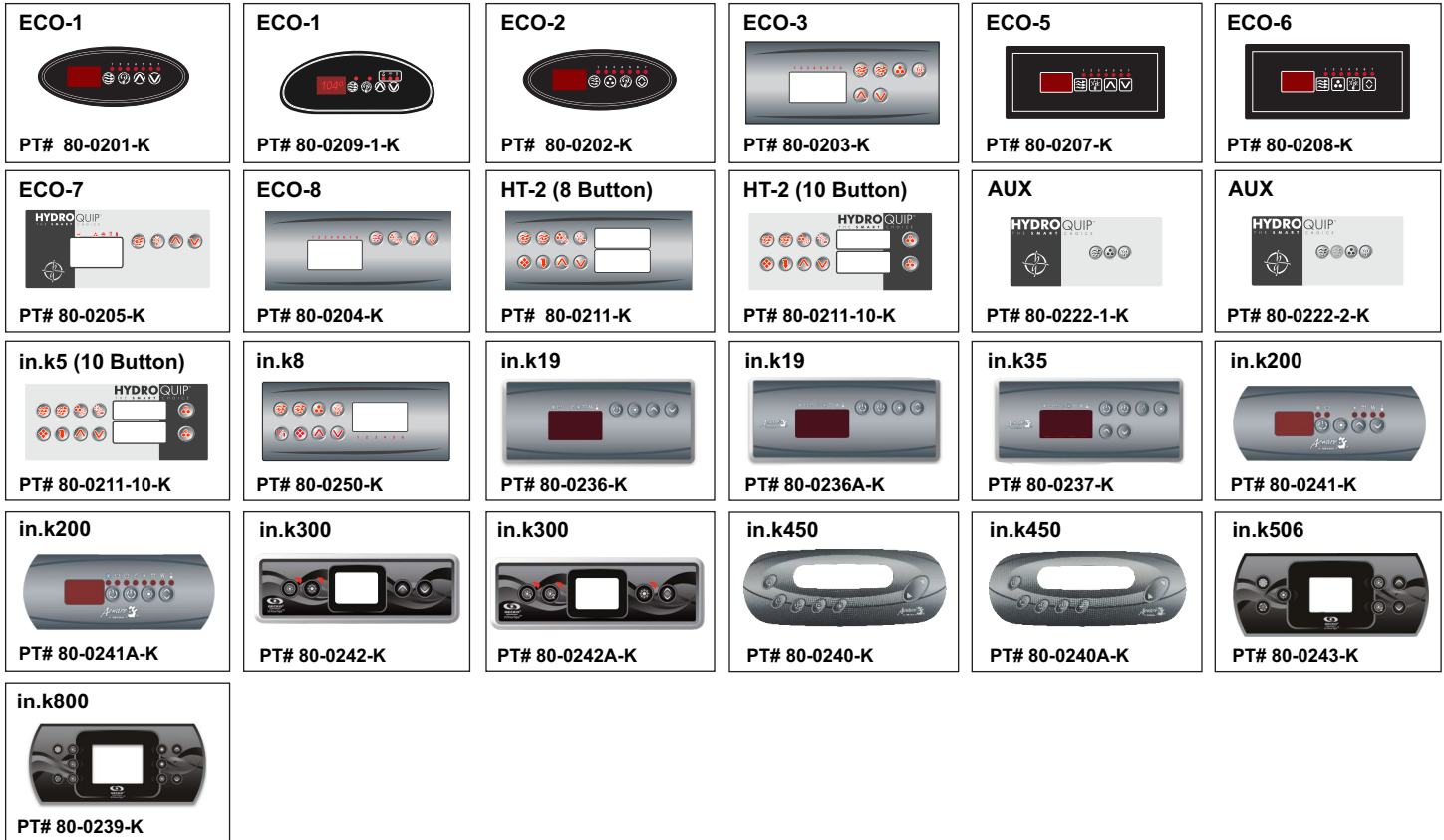





Parts

SERIES	PT #	DESCRIPTION
① S-Class	34-0193-K	ECO-1, 10', 4BTN, 4 1/2"x 2", w/Overlay: 80-0201, P1/L/UP/DN
① S-Class	34-0209-0	ECO-1, Crescent, 10', 4BTN, 4 1/2"x 2" w/Overlay: 80-0209-01, P1/LT/UP/DN
① S-Class	34-0200-K	ECO-2, 10', 4BTN, 4 1/2"x 2", w/Overlay: 80-0202, P1/BL/L/TEMP
① S-Class	34-0197-K	ECO-3, 10', 6BTN, 7"x 3 1/4", w/Overlay: 80-0203, P1/P2/BL/LT/UP/DN
① S-Class	34-0197-25-K	ECO-3, 25', 6BTN, 7"x 3 1/4", w/Overlay: 80-0203, P1/P2/BL/LT/UP/DN
① S-Class	34-0197-UB	ECO-3, 10', 6BTN, 10FT, No Bezel, No Overlay (Not Shown)
① S-Class	34-0207-K	ECO-5, 10', 4BTN, 5"x 2 1/2", w/Overlay: 80-0207, P1/LT/UP/DN
① S-Class	34-0207-25-K	ECO-5, 25', 4BTN, 5"x 2 1/2", w/Overlay: 80-0207, P1/LT/UP/DN
① S-Class	34-0208-K	ECO-6, 10', 4BTN, 5"x 2 1/2", w/Overlay: 80-0208, P1/BL/LT/TEMP
① S-Class	34-0208-25-K	ECO-6, 25', 4BTN, 5"x 2 1/2", w/Overlay: 80-0208, P1/BL/LT/TEMP
① S-Class	34-0198-K	ECO-7, 10', 4BTN, 7"x 3 1/4", w/Overlay: 80-0205, P1/LT/UP/DN
① S-Class	34-0198-UB	ECO-7/8, 10', 4BTN, 10FT, No Bezel, No Overlay (Not Shown)
① S-Class	34-0198A-K	ECO-8, 10', 4BTN, 7"x 3 1/4", w/Overlay: 80-0204, P1/BL/LT/TEMP
① M-Class	34-0190A-UB	HT-2, 10BTN, Obsolete, CONTACT FACTORY
① M-Class	34-0190A-K	HT-2, 10BTN, Obsolete, CONTACT FACTORY
① M-Class	34-0190-K	HT-2, 8BTN, Obsolete, CONTACT FACTORY
① M-Class	34-0189-K	HT-2, 8BTN, Obsolete, CONTACT FACTORY
① M-Class	48-0210-S	AUX, 4/3BTN, 18FT, 5" X 2-1/2", w/Overlay: 80-0222-1 & 80-0222-2
① M-Class	34-0196A-K	Remote, I/R, MP, w/Overlay: 80-0230-A
② Y Series	34-0244-K	in.k5, 10', 10BTN, 7"x 3 1/4", w/Overlay: 80-0211-10, P1/P2/BL/LT/PG/EC/UP/DN/A1/A2
② Y Series	34-0250-K	in.k8, 10', 8BTN, 7"x3 1/4", w/Overlay: 80-0250-K, P1/P2/BL/LT/M/PG/UP/DN
② Y Series	34-0236-K	in.k19, 10', 4BTN, 7" X 3-1/4", w/Overlay: 80-0236, P1/LT/UP/DN
② Y Series	34-0236A-K	in.k19, 10', 4BTN, 7" X 3-1/4", w/Overlay: 80-0236A, P1/AUX/LT/TEMP
② Y Series	34-0237-K	in.k35, 6BTN, Obsolete, Replaced by PT# 34-0250-K
② Y Series	34-0241-K	in.k200, 10', 4 BTN, 4-3/4" X 2", w/Overlay: 80-0241, P1/LT/UP/DN
② Y Series	34-0241A-K	in.k200, 10', 4 BTN, 4-3/4" X 2", w/Overlay: 80-0241A, P1/P2/LT/TEMP
② Y Series	34-0242-K	in.k300, 10', 4 BTN, 6-1/4" X 2-1/4", w/Overlay: 80-0242, P1/LT/UP/DN
② Y Series	34-0242A-K	in.k300, 10', 4 BTN, 6-1/4" X 2-1/4", w/Overlay: 80-0242A, P1/P2/LT/TEMP
② Y Series	34-0240-K	in.k450, 10', 6 BTN, 7-1/4" X 3", w/Overlay: 80-0240, ON/P1/P2/LT/UP/DN
② Y Series	34-0240A-K	in.k450, 10', 7 BTN, 7-1/4" X 3", w/Overlay: 80-0240A, ON/P1/P2/P3/LT/UP/DN
② Y Series	34-0243-K	in.k506, 10', 7 BTN, 7-1/8" X 3-3/8", w/Overlay: 80-0243, S/LT/M/P1/P2/UP/DN
② Y Series	34-0239-K	in.k800, 10', 8 BTN, 8-3/4" X 4-1/4", w/Overlay: 80-0239, S/M/P1/P2/P3/AUX1/AUX2/LT

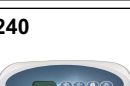

**Parts**

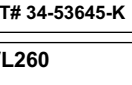
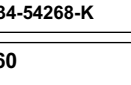
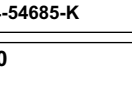
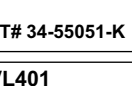
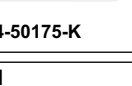























<b>SERIES</b>	<b>PT #</b>	<b>DESCRIPTION</b>
S-Class	80-0201-K	ECO-1, 4BTN, P1/L/UP/DN
S-Class	80-0209-1-K	ECO-1, Crescent, 4BTN, P1/LT/UP/DN
S-Class	80-0202-K	ECO-2, 4BTN, P1/BL/L/TEMP
S-Class	80-0203-K	ECO-3, 6BTN, P1/P2/BL/LT/UP/DN
S-Class	80-0207-K	ECO-5, 4BTN, P1/LT/UP/DN
S-Class	80-0208-K	ECO-6, 4BTN, P1/BL/LT/TEMP
S-Class	80-0205-K	ECO-7, 4BTN, P1/LT/UP/DN
S-Class	80-0204-K	ECO-8, 4BTN, P1/BL/LT/TEMP
S-Class	80-0222-1-K	AUX, 3BTN, P1/BL/LT
S-Class	80-0222-2-K	AUX, 4BTN, P1/P2/BL/LT
M-Class	80-0211-10-K	HT-2, 10BTN, P1/P2/BL/LT/PG/EC/UP/DN/ACC1/ACC2
M-Class	80-0211-K	HT-2, 8BTN, P1/P2/BL/LT/PG/EC/UP/DN
M-Class	80-0230-A-K	Remote, I/R, MP
Y Series	80-0211-10-K	in.k5, 10BTN, P1/P2/BL/LT/PG/EC/UP/DN
Y Series	80-0250-K	in.k8, 8BTN, P1/P2/BL/LT/M/PG/UP/DN
Y Series	80-0236-K	in.k19, 4BTN, P1/LT/UP/DN
Y Series	80-0236A-K	in.k19, 4BTN, P1/AUX/LT/TEMP
Y Series	80-0237-K	in.k35, 6BTN, P1/P2/AUX/LT/UP/DN
Y Series	80-0241-K	K200, 4 BTN, P1/LT/UP/DN
Y Series	80-0241A-K	K200, 4 BTN, P1/P2/LT/TEMP
Y Series	80-0242-K	K300, 4 BTN, P1/LT/UP/DN
Y Series	80-0242A-K	K300, 4 BTN, P1/P2/LT/TEMP
Y Series	80-0240-K	K450, 6 BTN, ON/P1/P2/LT/UP/DN
Y Series	80-0240A-K	K450, 7 BTN, ON/P1/P2/P3/LT/UP/DN
Y Series	80-0243-K	K506, 7 BTN, S/LT/M/P1/P2/UP/DN
Y Series	80-0239-K	K800, 8 BTN, S/M/P1/P2/P3/AUX1/AUX2/LT

 VL200 PT# 34-52144-K	 VL200 PT# 34-52312-K	 VL200 PT# 34-52487-K	 VL200 PT# 34-53238-K	 VL200 PT# 34-55123-K	 VL200 PT# 34-55431-K
 VL200 PT# 34-55563-K	 VL240 PT# 34-53565-K	 VL240 PT# 34-53643-K	 VL240 PT# 34-55080-K	 VL240 PT# 34-55456-K	 VL260 PT# 34-53566-K
 VL260 PT# 34-53645-K	 VL260 PT# 34-53777-K	 VL260 PT# 34-54268-K	 VL260 PT# 34-54685-K	 VL260 PT# 34-55049-K	 VL260 PT# 34-55050-K
 VL260 PT# 34-55051-K	 VL260 PT# 34-55081-K	 VL260 PT# 34-55559-K	 VL400 PT# 34-50175-K	 VL400 PT#34-50176-K	 VL400 PT#34-55129-K
 VL401 PT# 34-54094-K	 VL401 PT# 34-54135-K	 VL401 PT# 34-54251-K	 VL401 PT# 34-54665-K	<p><b>Panel Connector Style</b></p> <p>① 8-Pin Phone Jack Style </p> <p>VL Series</p>	

**VL Panel Series(Designed for VS/GS Systems)**

SERIES	PT #	DESCRIPTION
① VS Duplex	34-52144-K	VL200, LCD, 7', Panel: 53676, Overlay: 80-11095, B/J/T/L, 4.3" X 1.6"
① VS Duplex	34-52312-K	VL200, LCD, 7', Panel: 53676, Overlay: 80-11127, J/J/T/L, 4.3" X 1.6"
① VS Duplex	34-52487-K	VL200, LCD, 7', Panel: 53676, Overlay: 80-11219, J/T/L, 4.3" X 1.6"
① VS Duplex	34-53238-K	VL200, Heat Jacket System, 7', Panel: 53676, Overlay: 80-11393, W/C/J/L, 4.3" X 1.6"
① VS Duplex	34-55123-K	VL200, LCD, 7', Panel: 53676, Overlay: 80-11852, J/L/C/W, 4.3" X 1.6"
① VS Duplex	34-55431-K	VL200, LCD, 10', Panel: 54242, Overlay: 80-11219, J/T/L, 4.3" X 1.6"
① VS Duplex	34-55563-K	VL200, LCD, 7', Panel: 53676, Overlay: 80-11852, J/L/C/W, 4.3" X 1.6"
① VS Duplex	34-53565-K	VL240, LCD, 7', Panel: 53636, Overlay: 80-11520, B/J/T/L, 5.3" X 1.9", white trim
① VS Duplex	34-53643-K	VL240, LCD, 7', Panel: 53644, Overlay: 80-11520, B/J/T/L, 5.3" X 1.9", gray trim
① VS Duplex	34-55080-K	VL240, LCD, 7', Panel: 53636, Overlay: 80-11745, J/L/C/W, 5.3" X 1.9", white trim
① VS Duplex	34-55456-K	VL240, LCD, 7', Panel: 53644, Overlay: 80-11745, J/L/C/W, 5.3" X 1.9", gray trim
① VS Duplex	34-53566-K	VL260, LCD, 7', Panel: 53637, Overlay: 80-11521, B/J/T/L, 7" X 2.1", white trim
① VS Duplex	34-53645-K	VL260, LCD, 7', Panel: 53646, Overlay: 80-11521, B/J/T/L, 7" X 2.1", gray trim
① VS Duplex	34-53777-K	VL260, LCD, 10', Panel: 53646, Overlay: 80-11521, B/J/T/L, 7" X 2.1", gray trim
① VS Duplex	34-54268-K	VL260, LCD, 7', Panel: 50063, Overlay: 80-11521, B/J/T/L, 7" X 2.1", clear trim
① VS Duplex	34-54685-K	VL260, LCD, 7', Panel: 53646, Overlay: 80-11724, J/T/L, 7" X 2.1", gray trim
① VS Duplex	34-55049-K	VL260, LCD, 7', Panel: 53637, Overlay: 80-11725, J/J/T/L, 7" X 2.1", white trim
① VS Duplex	34-55050-K	VL260, LCD, 7', Panel: 53646, Overlay: 80-11725, J/J/T/L, 7" X 2.1", gray trim
① VS Duplex	34-55051-K	VL260, LCD, 7', Panel: 50063, Overlay: 80-11725, J/J/T/L, 7" X 2.1", clear trim
① VS Duplex	34-55081-K	VL260, LCD, 7', Panel: 53637, Overlay: 80-11746, J/L/C/W, 7" X 2.1"
① VS Duplex	34-55559-K	VL260, LCD, 7', Panel: 53646, Overlay: 80-12050, J/T/L, 7" X 2.1", gray trim
① VS Duplex	34-50175-K	VL400, LCD, 7', Panel: 55130, Overlay: 80-12238, L/T/J, 7.5" X 2.3"
① VS Duplex	34-50176-K	VL400, LCD, 7', Panel: 55130, Overlay: 80-12237, L/T/J/J, 7.5" X 2.3"
① VS Duplex	34-55129-K	VL400, LCD, 7', Panel: 55130, Overlay: 80-11822, L/T/J/A, 7.5" X 2.3"
① VS Duplex	34-54094-K	VL401, LCD, 7', Panel: 52424-01, Overlay: 80-10669, B/J/T/L, 6.3" X 2.2"
① VS Duplex	34-54135-K	VL401, LCD, 7', Panel: 52424-01, Overlay: 80-10839, J/T/L, 6.3" X 2.2"
① VS Duplex	34-54251-K	VL401, LCD, 7', Panel: 52424-01, Overlay: 80-11671, J/J/T/L, 6.3" X 2.2"
① VS Duplex	34-54665-K	VL401, LCD, 7', Panel: 52424-01, Overlay: 80-11885, J/L/C/W, 6.3" X 2.2"

Parts

 VL402 PT#34-54093-K	 VL402 PT# 34-54100-K	 VL402 PT#34-54107-K	 VL403 PT# 34-51676-K	 VL403 PT# 34-52345-K	 VL403 PT# 34-54104-K
 VL403 PT# 34-54105-K	 VL403 PT# 34-54664-K	 VL404 PT# 34-51223-K	 VL404 PT# 34-51225-K	 VL404 PT# 34-51248-K	 VL406T PT# 34-50217-K
 VL406T PT# 34-55349-K	 VL406T PT# 34-55570-K	 VL406U PT# 34-53272-K	 VL406U PT# 34-55350-K	 VL600S PT# 34-54547-K	 VL600S PT# 34-54548-K
 VL600S PT#34-54681-K	 VL620S PT# 34-50055-K	 VL700S PT# 34-53811-K	 VL700S PT# 34-54716-K	 VL701S PT# 34-51057-K	 VL701S PT# 34-51247-K
 VL701S PT# 34-51452-K	 VL701S PT# 34-53189-K	 VL701S PT# 34-54170-K	 VL701S PT# 34-55390-K	<b>Panel Connector Style</b>   VL Series ① 8-Pin Phone Jack Style	

**VL Panel Series(Designed for VS/GS Systems)**

SERIES	PT #	DESCRIPTION
① VS Duplex	34-54093-K	VL402, LCD, 7', Panel: 51876, Overlay: 80-10668, B/L/J/T, 7.3" X 3.2"
① VS Duplex	34-54100-K	VL402, LCD, 7', Panel: 51876, Overlay: 80-10721, L/J/T, 7.3" X 3.2"
① VS Duplex	34-54107-K	VL402, LCD, 7', Panel: 51876, Overlay: 80-10764, J/L/J/T, 7.3" X 3.2"
① VS Duplex	34-51676-K	VL403, LED, 7', Panel: 54130, Overlay: 80-10671, B/J/T/L, 6.3" X 2.2"
① VS Duplex	34-52345-K	VL403, LED, 7', Panel: 51499, Overlay: 80-11448, J/L/W/C, 6.3" X 2.2"
① VS Duplex	34-54104-K	VL403, LED, 7', Panel: 54130, Overlay: 80-10752, J/J/T/L, 6.3" X 2.2"
① VS Duplex	34-54105-K	VL403, LED, 7', Panel: 54130, Overlay: 80-10753, J/T/L, 6.3" X 2.2"
① VS Duplex	34-54664-K	VL403, LED, 7', Panel: 54130, Overlay: 80-11884, J/L/C/W, 6.3" X 2.2"
① VS Duplex	34-51223-K	VL404, LED, 25', Panel: 52825, Overlay: 80-10307, T/B/J/L, 7.3" X 3.2"
① VS Duplex	34-51225-K	VL404, LED, 25', Panel: 52825, Overlay: 80-10352, T/J/L, 7.3" X 3.2"
① VS Duplex	34-51248-K	VL404, LED, 25', Panel: 52825, Overlay: 80-10418, T/J/J/L, 7.3" X 3.2"
① VS Duplex	34-50217-K	VL406T, LCD, 7', Panel: 55413, Overlay: 80-12438, J/L/T, 7" X 3.4"
① VS Duplex	34-55349-K	VL406T, LCD, 7', Panel: 55413, Overlay: 80-11946, J/B/L/T, 7" X 3.4"
① VS Duplex	34-55570-K	VL406T, LCD, 7', Panel: 55413-01, Overlay: 80-12051, J/J/L/T, 7" X 3.4"
① VS Duplex	34-53272-K	VL406U, LCD, 10', Panel: 53271, Overlay: 80-11947, J/L/W/C, 7" X 3.4"
① VS Duplex	34-55350-K	VL406U, LCD, 7', Panel: 55417-01, Overlay: 80-11947, J/L/W/C, 7" X 3.4"
① VS Serial	34-54547-K	VL600S, LCD, 7', Panel: 54546-01, Overlay: 80-11773, J/B/L/W/M/C, 7" X 3.4"
① VS Serial	34-54548-K	VL600S, LCD, 7', Panel: 54546-01, Overlay: 80-11774, J/J/L/W/M/C, 7" X 3.4"
① VS Serial	34-54681-K	VL600S, LCD, 7', Panel: 54546-01, Overlay: 80-11877, J/A/L/W/M/C, 7" X 3.4"
① VS Serial	34-50055-K	VL620S, LCD, 7', Panel: 55582-01, Overlay: 80-12220, J/J/L/W/M/C, 7" X 3.4"
① VS Serial	34-53811-K	VL700S, LCD, 7', Panel: 53812, Overlay: 80-11688, W/M/C/L/B/J/J, 9.8" X 3.1"
① VS Serial	34-54716-K	VL700S, LCD, 7', Panel: 53812, Overlay: 80-11756, W/M/C/L/J/J, 9.8" X 3.1"
① VS Serial	34-51057-K	VL701S, LCD, 7', Panel: 54112-01, Overlay: 80-10328, M/W/J/B/L/C, 7.4" X 3.3"
① VS Serial	34-51247-K	VL701S, LCD, 7', Panel: 54112-01, Overlay: 80-10402, M/W/J/J/L/C, 7.4" X 3.3"
① VS Serial	34-51452-K	VL701S, LCD, 7', Panel: 54112-01, Overlay: 80-10429, M/J/L/W/C, 7.4" X 3.3"
① VS Serial	34-53189-K	VL701S, LCD, 7', Panel: 54112-01, Overlay: 80-10430, B/M/J/J/L/W/C, 7.4" X 3.3"
① VS Serial	34-54170-K	VL701S, LCD, 7', Panel: 54112-01, Overlay: 80-11159, A/M/W/J/J/L/C, 7.4" X 3.3"
① VS Serial	34-55390-K	VL701S, LCD, 7', Panel: 54112-01, Overlay: 80-11984, L/M/J/J/J/W/C, 7.4" X 3.3"



 PT# 34-54652-K	 PT# 34-54108-K	 PT# 34-54128-K	 PT# 34-54142-K	 PT# 34-54528-K	 PT# 34-52685-K
 PT# 34-52684-K	 PT# 34-53392-K	 PT# 34-54726-K	 PT# 34-55989-K	 PT# 34-53502-K	 PT# 34-55304-K
 PT# 34-55600-K	 PT# 34-52649-K	 PT# 34-53567-K	 PT# 34-55609-K	 PT# 34-52654-K	 PT# 34-54589-K
 PT# 34-55536-K	 PT# 34-55580-K	 PT# 34-50260-K	 PT# 34-50259-K	 PT# 34-50056-K	 PT# 34-50335-K
 PT# 34-55673-K	 PT#34-50261-K	 PT#34-50262-K	<p><b>Panel Connector Styles</b></p> <p>VL Series      ML Series      TP Series</p> ① 8-Pin Phone Jack Style*                  ② 8-Pin Molex Style**                  ③ 4-Pin Molex Style		

**VL Panel Series(Designed for VS/GS Systems)**

SERIES	PT #	DESCRIPTION
① VS Serial	34-54652-K	VL702S, LCD, 7", Panel: 54539-01, Overlay: 80-11790, B/MW/J/L/W/C, 10.3" X 4.6"
① VS Deluxe	34-54108-K	VL801D, LCD, 7", Panel: 54121-01, Overlay: 80-10763, T/MW/B/L/C/J/J, 7.4" X 3.3"
① VS Deluxe	34-54128-K	VL801D, LCD, 7", Panel: 54121-01, Overlay: 80-10823, T/MW/B/L/C/J/A, 7.4" X 3.3"
① VS Deluxe	34-54142-K	VL801D, LCD, 7", Panel: 54121-01, Overlay: 80-10841, T/MW/L/C/J/J, 7.4" X 3.3"
① VS Deluxe	34-54528-K	VL802D, LCD, 7", Panel: 54562-01, Overlay: 80-11789, T/MW/B/L/C/J/J, 10.3" X 4.6"

**ML Panel Series(Designed for EL/GL Systems)**

② EL/GL	34-52685-K	ML200, LCD, Panel:53292, Overlay: 80-11344, J/A/T/L, 4.3" X 1.6"
② EL/GL	34-52684-K	ML400, LCD, 7", Panel: 53291, Overlay: 80-11345, J/A/T/L, 7.5" X 2.3"
② EL/GL	34-53392-K	ML550, LCD, 7", Panel: 53393, Overlay: 80-11909, C/W/J/J/B/L/M, 13.7" X 2.5"
② EL/GL	34-54726-K	ML550, LCD, 7", Panel: 53393, Overlay: 80-11901, C/W/J/J/J/L/M, 13.7" X 2.5"
② EL/GL	34-55989-K	ML550, LCD, 7", Panel: 53393, Overlay: 80-12183, C/W/J/J/J/L/M, 13.7" X 2.5"
② EL/GL	34-53502-K	ML551, LCD, 7", Panel: 53503-02, Overlay: 80-11609, L/MW/J/J/B/C, 7.4" X 3.3"
② EL/GL	34-55304-K	ML551, LCD, 7", Panel: 53503-02, Overlay: 80-11899, L/M/J/J/J/W/C, 7.4" X 3.3"
② EL/GL	34-55600-K	ML551, LCD, Panel: 53503-02, Overlay: 80-12052, J/L/M/J/J/J/W/C, 7.4" X 3.3"
② EL/GL	34-52649-K	ML700, LCD, Panel: 50563, Overlay: 80-11281, T/W/MC/L/B/J/J, 9.8" X 3.1"
② EL/GL	34-53567-K	ML700, LCD, Panel: 50563, Overlay: 80-11476, T/W/MC/L/J/J/J, 9.8" X 3.1"
② EL/GL	34-55609-K	ML700, LCD, Panel: 50563, Overlay: 80-12053, T/W/MC/L/B/J, 9.8" X 3.1"
② EL/GL	34-55536-K	ML900, LCD, Panel: 52797-04, Overlay: 80-12037, T/W/MC/J/J/J/J/I/L/B/J, 11.7" X 3.2"
② EL/GL	34-54589-K	ML900, LCD, Panel: 52797-04, Overlay: 80-11806, T/W/MC/J/J/J/J/I/V/L/O, 11.7" X 3.2"
② EL/GL	34-55580-K	ML900, LCD, Panel: 52797-04, Overlay: 80-12132, T/W/MC/J/J/J/J/I/L/B/O, 11.7" X 3.2"
② EL/GL	34-52654-K	ML900, LCD, Panel: 52797-04, Overlay: 80-40026, T/W/MC/J/J/J/O/I/V/L/B, 11.7" X 3.2"

**TP Panel Series(Designed for BP Systems)**

③ BP	34-50260-K	TP400T, BP, 7", Panel: 55701-04, Overlay: 80-12511, T/J/L/A, 8.3" X 2.5"
③ BP	34-50259-K	TP400W, BP, 7", Panel: 55702-03, Overlay: 80-12510, W/C/L/J, 8.3" X 2.5"
③ BP	34-55673-K	TP600, BP, 7", Panel: 55676-11, Overlay: 80-12101, J/A/F/W/L/C, 7.1" X 3.5"
③ BP	34-50056-K	TP600, BP, 7", Panel: 55676-11, Overlay: 80-12198, J/J/F/W/L/C, 7.1" X 3.5"
③ BP	34-50335-K	TP600, BP, 7", Panel: 55676-11, Overlay: 80-12762, J/J/A/W/L/C, 7.1" X 3.5"
③ BP	34-50261-K	TP800, BP, 7", Panel: 50204-09, Overlay: 80-12512, 9 button, 10" X 3.5"
③ BP	34-50262-K	TP900, BP, 7", Overlay: 80-12513, 10" X 4.5"

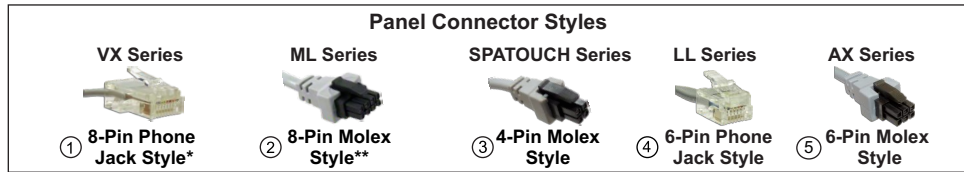

**SPATOUCH Panel Series(Designed for BP Systems)**

<i>SERIES</i>	<i>PT #</i>	<i>DESCRIPTION</i>
③ BP	34-50403-K	Spatouch, Oval, Panel: 50404, Overlay: 80-12975, 8.8" X 4.9"
③ BP	34-50401-K	Spatouch, Rectangle Panel: 50402, Overlay: 80-12974, 5.6" X 4.4"
③ BP	34-50390-K	Spatouch, Trapezoid, Panel: 50391, Overlay: 80-12966, 7.8" X 4.7"

**LITE LEADER Panel Series(Designed for LL / ICON Systems)**

④ LL	34-51705-K	Lite Leader, 7", Overlay: 80-10694, L-J/T, 4.6" X 2.3"
④ LL	34-52274-K	VL401, LL ICON15, LCD, 7", Overlay: 80-11853, W/J/L/C, 6.3" X 2.2"















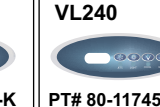
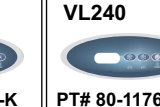
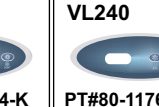

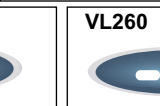

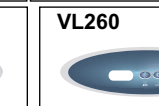
**AX Panel Series(Designed for EL/GL & BP Systems)**

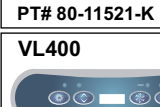
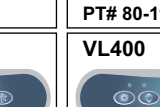
⑤ EL/GL/BP	34-52683-K	AX10, 18', Panel: 52803, Overlay: 80-40105, Jets 1, 2.2" X 2.2"
⑤ EL/GL/BP	34-55532-K	AX10, 18', Panel: 52803, Overlay: 80-11908, Jets 4, 2.2" X 2.2"
⑤ EL/GL/BP	34-55533-K	AX10, 18', Panel: 52803, Overlay: 80-11907, Jets 3, 2.2" X 2.2"
⑤ EL/GL/BP	34-55936-K	AX10, 18', Panel: 52803, Overlay: 80-12122, Jets 5, 2.2" X 2.2"
⑤ EL/GL/BP	34-52682-K	AX20, 18', w/Overlay: 80-40096, J/J, 5.8" X 2.3"
⑤ EL/GL/BP	34-52746-K	AX20, 18', w/Overlay: 80-40096, J/J, 5.8" X 2.3"
⑤ EL/GL/BP	34-52747-K	AX20, 18', w/Overlay: 80-40097, J/L, 5.8" X 2.3"
⑤ EL/GL/BP	34-52678-K	AX40, 18', Panel: 52799, Overlay: 80-40030, J/J/B/L, 7.5" X 2.3"
⑤ EL/GL/BP	34-53334-K	AX40, 18', Panel: 52799, Overlay: 80-11428, J/J/B/J, 7.5" X 2.3"
⑤ EL/GL/BP	34-55487-K	AX40, 18', Panel: 52799, Overlay: 80-11823, J/J/J/J, 7.5" X 2.3"

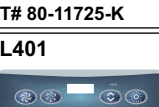
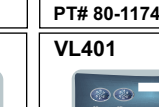
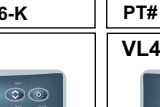
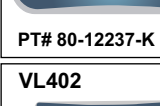
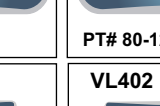
**VX Panel Series(Designed for VS/GS Systems)**

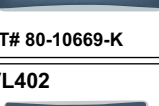
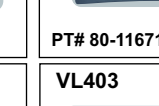
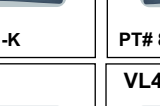
① Duplex	34-51574-K	VX40S, Aux, 18', VS, Panel: 52576, Overlay: 80-10559, J/J/B/L, 7.2" X 2.5"
----------	------------	--

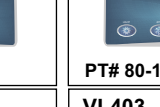
**Parts**

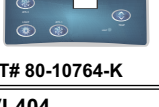
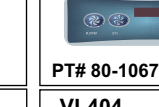
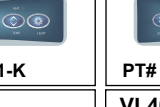
 PT# 80-11095-K	 PT# 80-11127-K	 PT# 80-11219-K	 PT# 80-11852-K	 PT# 80-11520-K	 PT# 80-11745-K	 PT# 80-11764-K	 PT# 80-11765-K
 PT# 80-11521-K	 PT# 80-11724-K	 PT# 80-11725-K	 PT# 80-11746-K	 PT# 80-12050-K	 PT# 80-11822-K		
 PT# 80-12237-K	 PT# 80-12238-K	 PT# 80-10669-K	 PT# 80-11671-K	 PT# 80-10839-K	 PT# 80-11885-K		
 PT# 80-10668-K	 PT# 80-10721-K	 PT# 80-10764-K	 PT# 80-10671-K	 PT# 80-10752-K	 PT# 80-10753-K		
 PT# 80-11448-K	 PT# 80-11884-K	 PT# 80-10307-K	 PT# 80-10352-K	 PT# 80-10418-K	 PT# 80-11946-K		

### VL Panel Overlays (Designed for VS/GS Systems)

SERIES	PT #	DESCRIPTION
VS Duplex	80-11095-K	VL200, DUP, OV, B/J/T/L
VS Duplex	80-11127-K	VL200, DUP, OV, J/J/T/L
VS Duplex	80-11219-K	VL200, J/T/L
VS Duplex	80-11852-K	VL200, DUP, OV, J/L/C/W
VS Duplex	80-11520-K	VL240, B/J/T/L
VS Duplex	80-11745-K	VL240, J/L/C/W
VS Duplex	80-11764-K	VL240, J/J/T/L
VS Duplex	80-11765-K	VL240, J/T/L
VS Duplex	80-11521-K	VL260, B/J/T/L
VS Duplex	80-11724-K	VL260, J/T/L
VS Duplex	80-11725-K	VL260, J/J/T/L
VS Duplex	80-11746-K	VL260, J/L/C/W
VS Duplex	80-12050-K	VL260, A/J/T/L
VS Duplex	80-11822-K	VL400, L/T/J/A
VS Duplex	80-12237-K	VL400, L/T/J/J
VS Duplex	80-12238-K	VL400, L/T/J
VS Duplex	80-10669-K	VL401, DUP, RE, B/J/T/L
VS Duplex	80-11671-K	VL401, DUP, RE, J/J/T/L
VS Duplex	80-10839-K	VL401, DUP, RE, J/T/L
VS Duplex	80-11885-K	VL401, DUP, RE, J/L/C/W
VS Duplex	80-10668-K	VL402, B/L/J/T
VS Duplex	80-10721-K	VL402, L/J/T
VS Duplex	80-10764-K	VL402, J/L/J/T
VS Duplex	80-10671-K	VL403, B/J/T/L
VS Duplex	80-10752-K	VL403, J/J/T/L
VS Duplex	80-10753-K	VL403, J/T/L
VS Duplex	80-11448-K	VL403, J/L/W/C
VS Duplex	80-11884-K	VL403, J/L/C/W
VS Duplex	80-10307-K	VL404, T/B/J/L
VS Duplex	80-10352-K	VL404, T/J/L
VS Duplex	80-10418-K	VL404, T/J/J/L
VS Duplex	80-11946-K	VL406T, J/B/L/T

Parts

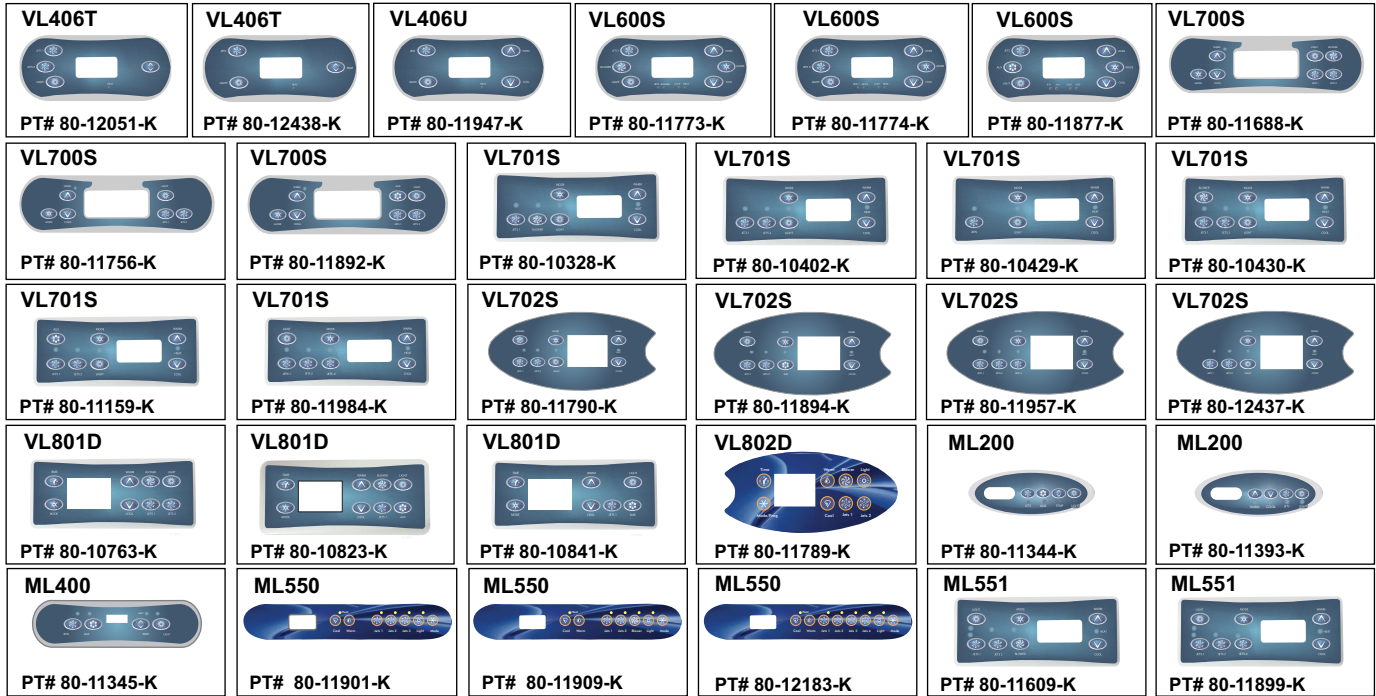

**VL Panel Overlays (Designed for VS/GS Systems)**

<b>SERIES</b>	<b>PT #</b>	<b>DESCRIPTION</b>
VS Duplex	80-12051-K	VL406T, J/J/L/T
VS Duplex	80-12438-K	VL406T, J/L/T
VS Duplex	80-11947-K	VL406U, J/L/W/C
VS Serial	80-11773-K	VL600S, J/B/L/W/M/C
VS Serial	80-11774-K	VL600S, J/J/L/W/M/C
VS Serial	80-11877-K	VL600S/VL620S, SER, OV, J/A/L/W/M/C
VS Serial	80-11688-K	VL700S, W/M/C/L/B/J/J
VS Serial	80-11756-K	VL700S, W/M/C/L/J/J
VS Serial	80-11892-K	VL700S, W/M/C/A/L/J/J
VS Serial	80-10430-K	VL701S, B/M/J/J/L/W/C
VS Serial	80-10328-K	VL701S, SER, RE, M/J/B/L/W/C
VS Serial	80-10402-K	VL701S, M/W/J/J/L/C
VS Serial	80-10429-K	VL701S, M/J/L/W/C
VS Serial	80-11159-K	VL701S, SER, RE, A/M/J/J/L/W/C
VS Serial	80-11984-K	VL701S, SER, RE, L/M/J/J/J/W/C
VS Serial	80-11790-K	VL702S, B/M/J/J/L/W/C
VS Serial	80-11894-K	VL702S, L/M/J/J/L/W/C
VS Serial	80-11957-K	VL702S, L/M/J/J/J/W/C
VS Serial	80-12437-K	VL702S, M/J/J/L/W/C
VS Deluxe	80-10823-K	VL801D, T/M/W/B/L/C/J/A
VS Deluxe	80-10763-K	VL801D, T/M/W/B/L/C/J/J
VS Deluxe	80-10841-K	VL801D, T/M/W/L/C/J/J
VS Deluxe	80-11789-K	VL801D, T/M/W/B/L/C/J/J

**ML Panel Overlays (Designed for EL/GL Systems)**

EL/GL	80-11344-K	ML200, J/A/T/L
EL/GL	80-11393-K	ML200, W/C/J/L
EL/GL	80-11345-K	ML400, J/A/T/L
EL/GL	80-11901-K	ML550, C/W/J/J/J/L/M
EL/GL	80-11909-K	ML550, C/W/J/J/B/L/M
EL/GL	80-12183-K	ML550, C/W/J/J/J/L/M
EL/GL	80-11609-K	ML551, EL, RE, L/M/W/J/J/B/C
EL/GL	80-11899-K	ML551, EL, RE, L/M/J/J/J/W/C

**Parts**

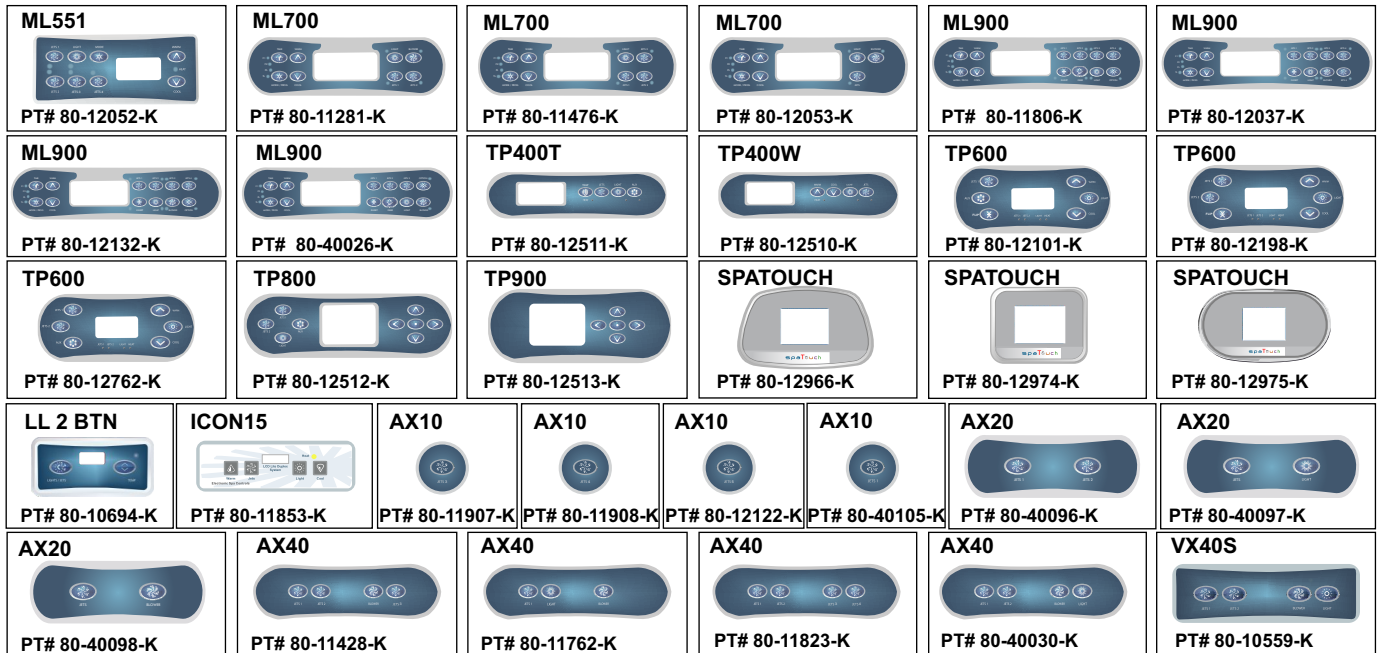

### ML Panel Overlays(Designed for EL/GL Systems)

SERIES	PT #	DESCRIPTION
EL/GL	80-12052-K	ML551, EL, RE, J/L/M/J/J/J/W/C
EL/GL	80-11281-K	ML700, T/W/M/C/L/B/J/J
EL/GL	80-11476-K	ML700, T/W/M/C/L/J/J/J
EL/GL	80-12053-K	ML700, T/W/M/C/L/B/J
EL/GL	80-11806-K	ML900, T/W/M/C/J/J/J/J/W/L/O
EL/GL	80-12037-K	ML900, T/W/M/C/J/J/J/J/W/L/B/O
EL/GL	80-12132-K	ML900, T/W/M/C/J/J/J/J/W/L/B/O
EL/GL	80-40026-K	ML900, T/W/M/C/J/J/J/O/W/L/B

### TP Panel Overlays(Designed for BP Systems)

BP	80-12511-K	TP400T, BP, OB, T/J/L/A
BP	80-12510-K	TP400W, BP, OB, W/C/L/J
BP	80-12101-K	TP600, BP, OV, J/A/F/W/L/C
BP	80-12198-K	TP600, BP, OV, J/J/F/W/L/C
BP	80-12762-K	TP600, BP, OV, J/J/A/W/L/C
BP	80-12512-K	TP800, BP, OB, J/J/L/A
BP	80-12513-K	TP900, 5 BUTTON
BP	80-12966-K	SPATOUCH, Trapazoid
BP	80-12974-K	SPATOUCH, Rectangle
BP	80-12975-K	SPATOUCH, Oval

### LL Panel Overlays(Designed for Lite Leader Systems)

LL	80-10694-K	LL, J-L/T
LL	80-11853-K	LL ICON, W/J/L/C

### AX Panel Overlays(Designed for EL/GL/BP Systems)

EL/GL/BP	80-11907-K	AX10, Jets 3
EL/GL/BP	80-11908-K	AX10, Jets 4
EL/GL/BP	80-12122-K	AX10, Jets 5
EL/GL/BP	80-40105-K	AX10, Jets 1
EL/GL/BP	80-40096-K	AX20, J/J
EL/GL/BP	80-40097-K	AX20, J/L
EL/GL/BP	80-40098-K	AX20, J/B
EL/GL/BP	80-11428-K	AX40, J/J/B/J
EL/GL/BP	80-11762-K	AX40, J/L/B
EL/GL/BP	80-11823-K	AX40, J/J/J/J
EL/GL/BP	80-40030-K	AX40, J/J/B/L

### VX Panel Overlays(Designed for VS/GS Systems)

Duplex	80-10559-K	VX40S, VS, RE, J/J/B/L
--------	------------	------------------------

Parts

### BALBOA® SERIES

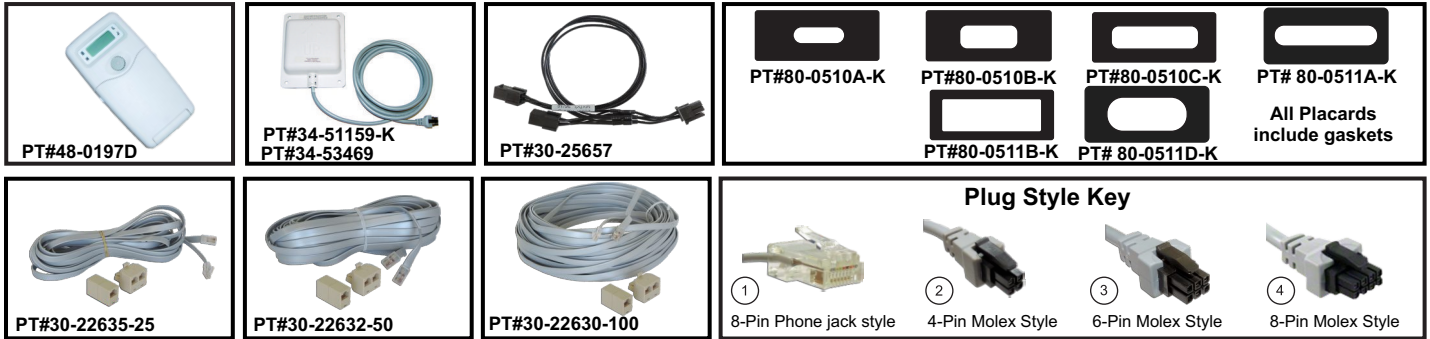

\*Molex Only \*\*Phone jack style

OLD PART#	NEW PART#	DESCRIPTION
48-0197D	N/A	Wireless Remote, Kit,R/F, Includes Receiver #53469 In-House Remote #53468
48-0197A	N/A	Wireless Remote - DISCONTINUED (not shown)
34-0216E	34-51159-K	BP Series, Module, Wi-Fi Kit
34-0216B	34-53469	Remote, Transceiver, Balboa, I/H
30-0095	30-25657	Adapter, BP Series, "Y" Cable, Wi-Fi, BWG# 25657
80-0510A-K	N/A	Placard Kit, ML200, ML240, ML260, VL200, VL240, VL260, 8.5" X 4"
80-0510B-K	N/A	Placard Kit, Lite Leader, 8.5" X 4"
80-0510C-K	N/A	Placard Kit, AX40, ML400, VL400, VL401, VL403, 8.5" X 4"
80-0511B-K	N/A	Placard Kit, ML551, VL402, VL404, VL701S, VL801D, 8.5" X 4"
N/A	80-0511A-K	Placard Kit, TP400T, TP400W, 9.06" X 4"
N/A	80-0511D-K	Placard Kit, TP600, VL406T, VL406U, VL600S, VL620S, 9.06" X 4"
① 30-1016-25**	30-22635-25	Ext, 25' VS, 8Pin, with 2 to 1 & 1 to 1 connectors
① 30-1016-50**	30-22632-50	Ext, 50' VS, 8Pin, with 2 to 1 & 1 to 1 connectors
① 30-1016-100**	30-22630-100	Ext, 100' VS, 8Pin, with 2 to 1 & 1 to 1 connectors
② 30-1017-7*	30-25662-7	Ext, 7' BP, 4Pin, <b>Also for Wi-Fi Module (Not Shown)</b>
② 30-1017-25*	30-25662-25	Ext, 25' BP, 4Pin, <b>Also for Wi-Fi Module</b>
② 30-1017-50*	30-25662-50	Ext, 50' BP, 4Pin, <b>Also for Wi-Fi Module</b>
② 30-1017-100*	30-25662-100	Ext, 100' BP, 4Pin, <b>Also for Wi-Fi Module</b>
③ 30-1015-25*	30-11589-25	Ext, 25' EL, 6Pin, Aux
③ 30-1015-50*	30-11589-50	Ext, 50' EL, 6Pin, Aux
③ 30-1015-100*	30-11589-100	Ext, 100' EL, 6Pin, Aux
④ 30-1014-25*	30-11588-25	Ext, 25' EL, 8-Pin, Main
④ 30-1014-50*	30-11588-50	Ext, 50' EL, 8Pin, Main
④ 30-1014-100*	30-11588-100	Ext, 100' EL, 8Pin, Main

### GECKO SERIES



PART#	DESCRIPTION
30-1011-9	Ext, 9', Mspa/Sspa
30-1011-20	Ext, 20', Mspa/Sspa
30-1011-25	Ext, 25', Mspa/Sspa
34-0216G-K	WiFi, Module, In.Touch2, Y Series
80-0510A-K	Placard Kit, ECO-1,2,5,6 Series, 8.5" X 4"
80-0511B-K	Placard Kit, HT-2 & ECO-3,7,8 Series, 8.5" X 4"

PARTS

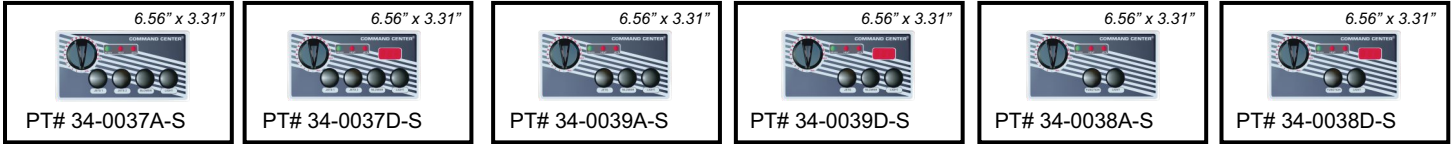

PART NUMBER	DESCRIPTION	INCLUDES
34-0037A-S	Spaside Kit, TDI CC4, 120V, 6' Cord, 4BTN Label	Label: 80-0132A
34-0039A-S	Spaside Kit, TDI CC3, 120V, 6' Cord, 3BTN Label	Label: 80-0134A
34-0038A-S	Spaside Kit, TDI CC2, 120V, 6' Cord, 2BTN Label	Label: 80-0130A
34-0037D-S	Spaside Kit, TDI CC4D, 120V, 6' Cord, Digital, 4BTN Label	Label: 80-0134D
34-0039D-S	Spaside Kit, TDI CC3D, 120V, 6' Cord, Digital, 3BTN Label	Label: 80-0132D
34-0038D-S	Spaside Kit, TDI CC2D, 120V, 6' Cord, Digital, 2BTN Label	Label: 80-0130D
80-0499	Placard, LG to TDI, Full Size, 8.25" X 3.25" (not shown)	
09-0004	Receptacle, Spaside Control (not shown)	

## Switches, Transmitters & Lights



PART NUMBER	DESCRIPTION
34-0002-K	Air Switch, 125/250V, 25A, SPDT
34-0059-K	Air Switch, 125/250V, 20A, DPDT
34-0020-K	Rocker Switch, SPDT, 125V, 16A
34-0154	Air Switch, 3 Function, 250V, 21A
36-0006	Air Transmitter, Chrome, #15, 1 3/8"
36-0004A-K	Air Transmitter, White, #15, 1 1/4"
64-0001B	Tubing, 1/4"OD X 1/8" ID, Clear (per ft)
64-0001B-5	Tubing, 1/4"OD X 1/8" ID, Clear (5 ft roll)
64-0001B-10	Tubing, 1/4"OD X 1/8" ID, Clear (10 ft roll)
64-0001B-100	Tubing, 1/4"OD X 1/8" ID, Clear (100 ft roll)
64-0012	Tubing, Long Distance, 1/8"OD X 1/16" ID, Clear (per ft)
37-0029-SM	Light Kit, 120V, W/Wall Fitting
37-0031-SM	Light Kit, 120V, L/Wall Fitting
25-0002-K	Light, Rear Access and Wall Fitting, no Bulb
37-0001-K	Light Lead, 2-Pin, 8'
25-21089-HQ-K	Light Assembly with Light Lead 8', Bulb & Reflector
37-0014-K	Light Bulb, 12 Watt
37-0014-L-K	Light Bulb, LED 1.4W 10S Series
42-LED-10S	<b>Obsolete, use 34-0014-L-K</b>

Parts

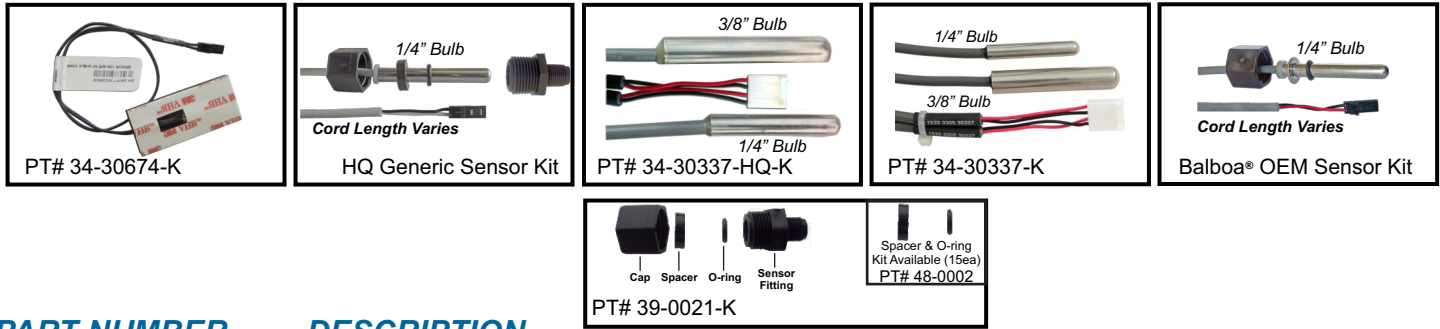

PART NUMBER	DESCRIPTION
34-30674-K	Balboa® OEM Sensor, M7®, 12", Temp/HL, Stick On, Cal Spa Series
34-0202B-K	HQ Generic Sensor Kit, M7®, 46", 1/4" Bulb, Balboa®, All Slide Series
34-0202C-K	HQ Generic Sensor Kit, M7®, 82", 1/4" Bulb, Balboa®, Versi-Heat Series
34-30337-HQ-K	HQ Generic Sensor Kit, Dual, Temp/HL, 36"(1/4" Bulb), 96"(3/8" Bulb)
34-30337-K	Balboa® OEM Sensor Kit, Dual, Temp/HL, 36"(1/4" Bulb), 96"(3/8" Bulb)
34-53605-HQ-K	HQ Generic Sensor Kit, M7®, 12", 1/4" Bulb, Includes complete sensor fitting
34-53605-K	Balboa® OEM Sensor Kit, M7®, 12", 1/4" Bulb
34-32016-HQ-K	HQ Generic Sensor Kit, M7®, 24", 1/4" Bulb, Includes complete sensor fitting
34-32016-K	Balboa® OEM Sensor Kit, M7®, 24", 1/4" Bulb
39-0021-K	M7® Sensor Fitting Kit, Includes: Body, Cap, Spacer, and O-Ring
48-0002	M7® Spacer & O-Ring Kit (15 of each per kit)

All HQ Generic M7® Sensor Kits Include Fitting Kit PT# 39-0021-K

## Sensors - Gecko Series

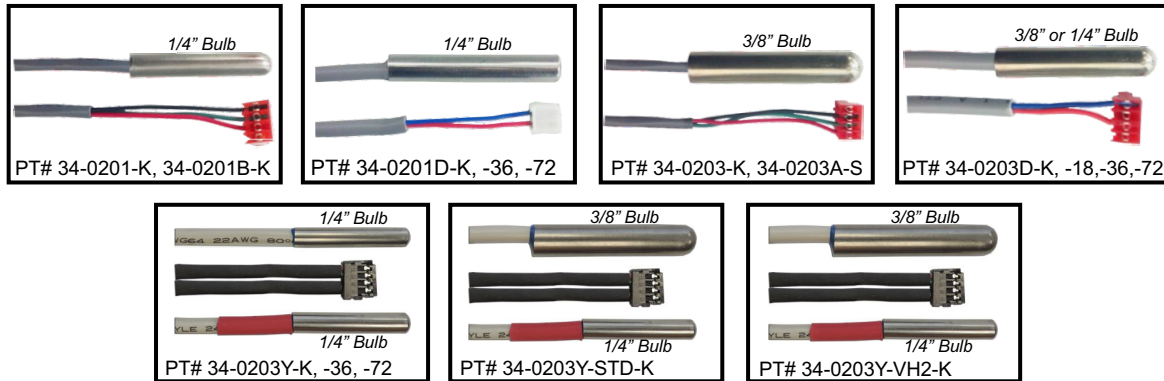

PART NUMBER	DESCRIPTION
34-0201-K*	Sensor, HL, 4P3W, W/M/T, 14", 1/4" Bulb - Gecko# 9920-400122
34-0201B-K*	Sensor, HL, 4P3W, W/M/T, 76", 1/4" Bulb - Gecko# 9920-400684
34-0201D-K	Sensor, HL, 2P2W, MP/SSPA/USPA, 18", 1/4" Bulb
34-0201D-36-K	Sensor, HL, 2P2W, MP/SSPA/USPA, 36", 1/4" Bulb
34-0201D-72-K	Sensor, HL, 2P2W, MP/SSPA/USPA, 72", 1/4" Bulb
34-0203-K*	Sensor, Temp, 4P3W, W/M/T, 10FT, 3/8" Bulb - Gecko# 9920-400125
34-0203A-S*	Sensor, Temp, 4P3W, W/M/T, 25FT., 3/8" Bulb - Gecko# 9920-400245
34-0203D-K	Sensor, Temp, MP/SSPA/USPA, 4P2W, 10FT, 3/8" Bulb - Gecko# 9920-400262
34-0203D-18-K	Sensor, Temp, MP/SSPA/USPA, 4P2W 18", 1/4" Bulb
34-0203D-36-K	Sensor, Temp, MP/SSPA/USPA, 4P2W, 36", 1/4" Bulb
34-0203D-72-K	Sensor, Temp, MP/SSPA/USPA, 4P2W, 72", 1/4" Bulb
34-0203Y-K	Sensor, Temp/HL, Y Series, 18", 1/4" Bulb
34-0203Y-36-K	Sensor, Temp/HL, Y Series, 36", 1/4" Bulb
34-0203Y-72-K	Sensor, Temp/HL, Y Series, 72", 1/4" Bulb
34-0203Y-STD-K	Sensor, Temp/HL, 120"(3/8" Bulb), 18"(1/4" Bulb), Y Series
34-0203Y-VH2-K	Sensor, Temp/HL, 120"(3/8" Bulb), 72"(1/4" Bulb), Y Series

\*Only applicable to system series: CS7100/CS6100, CS9300, CS9400 & CS9600 manufactured prior to mid 2003.



# Sensors - Gecko Series Cont. Sensor Replacement Kits



PART NUMBER	DESCRIPTION
09-0044-K	Thermowell, Wet-Well, 3/8", Hole size 1", 2.36"L X 1.53"W
09-0044B-K	Thermowell, Dry-Well, 3/8", C&S w/ plug, Hole size 1.125", 2.85"L X 1.48"W
09-0044-K	Thermowell Kit, Dry-Well, 3/8", w/ plug, Hole size 1.125", 2.85"L X 1.80"W
34-01395-K	Replacement Sensor Kit for Watkins, Includes Temp Sensor, Hi-Limit & 2 O-Rings <b>Replaces: RME-01395, 39525, 39530</b>
60-0028-K	Replacement O-Ring Kit for Watkins Sensors, Includes Hi-Limit & Temp Sensor O-Rings

## GFCI'S & Transformers



PART NUMBER	DESCRIPTION
30-0061B-K	GFCI Powercord, 15A, 90 Degree, 16' STW, Outdoor/Indoor
30-0061C-K	GFCI Powercord, 15A, 90 Degree, 16' SJTW, Indoor Only
30-0061D-K	GFCI Powercord, 15A, Inline, 16' STW, Outdoor/Indoor
30-0062-K	GFCI Powercord, 20A, Inline, 16' STW, Outdoor/Indoor
34-0013	<del>GFCI, 50A High Current, DISCONTINUED BY LEVITON - Refer to PT# 48-0154 on Pg. 8.24</del>
34-0007	GFCI, 20A, Panel Mount, 120V
34-0084-K	GFCI, 15A, 90 Degree, Cord End, For Cord Gauges 12/3, 14/3, 16/3 SJTW
37-0002-K	Transformer, Light, 120-12V, 1AMP
37-0005-K	Transformer, BAP, 120- 24V, 1AMP
37-0051-K	Transformer, PCB, 120V (series: 4/6200, 4/6220, 4/6230, 4/6330)
37-0051A	<del>Transformer, PCB, 240V (series: 4/6200, 4/6220, 4/6230, 4/6330)</del> CONTACT FACTORY
37-0052A-K	Transformer, Balboa®, 120V, LL
37-0053-K	Transformer, 120V, Y Series
37-0053B-K	Transformer, 240V, Y Series
48-0099X-120	Transformer Kit, 120V, MSPA/MP Series
48-0099X-240	Transformer Kit, 240V, MSPA/MP Series



<b>PART NUMBER</b>	<b>DESCRIPTION</b>
30-01395-K	Plug adapters for Double Barrel Htr, Temp & HL Sensor for use in IQ2000(1995-2002)
41-0010	Heater Current Collector
48-0021	Control Riser Kit, 1" Spacers and Screws helps elevate the control box.
48-0041-K	Turn-Around, Double Barrel Heater Manifold Kit
48-0041A-K	Gasket Kit for Double Barrel Heater
48-0041B-K	Barb, 3/4" Kit for Double Barrel Heater
48-0154	HC GFCI Removal Kit; 2 wire nuts, 2 hole plugs & wiring instructions
60-0008	Gasket, 1/2", Heater, Current Collector, Brett
60-0022-K*	O-ring, Heater Bulkhead (O-rings included with PT# 48-0079)

**Parts**

\*Heater Bulkhead O-rings available in bundles of 10, 100, 500 & 1000 only.

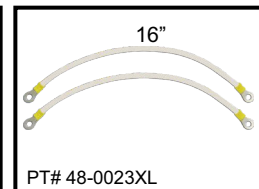
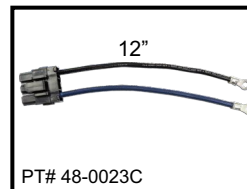
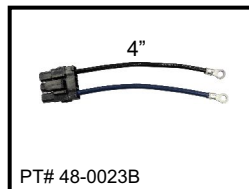
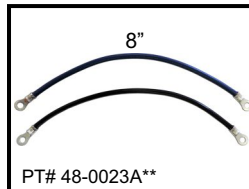
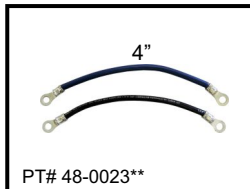
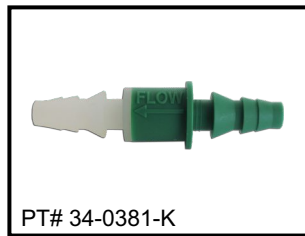

**\*\*Balboa heater to board connecting wires**

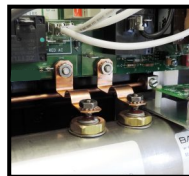

Balboa copper jumper straps



Replacement HQ heater wire kit installed

**Parts**

<b>PART NUMBER</b>	<b>DESCRIPTION</b>
34-54451	Ozone Generator, CD, BWG, 120V
34-0381-K	Ozone Check Valve Kit
34-0382	Ozone Intake Fliter (Not Shown)
34-54873-K	Balboa® UV Lamp Replacement, BWG# 54873, 5W, 120V
48-0023	Heater Wire Kit, #10 x 4" Pair; replaces Balboa copper jumper straps, heater to board
48-0023A	Heater Wire Kit, #10 x 8" Pair; replaces Balboa copper jumper straps, heater to board
48-0023B	Heater Connection Kit, #10 x 4" x BP; connects BP board to heater terminals
48-0023C	Heater Connection Kit, #10 x 12" x BP; connects BP board to heater terminals
48-0023XL	Heater Connection Kit, #10 x 16" Pair, Cal XL, connects heater terminals to board
15-0034	Base, 18"X26"X2", 8000 Outdoor Series (not shown)
15-0037A	Base, 14.5"X15", ES Air and Gecko Series (not shown)
15-0037B	Base, 14.5"X15", ES Balboa Series (not shown)

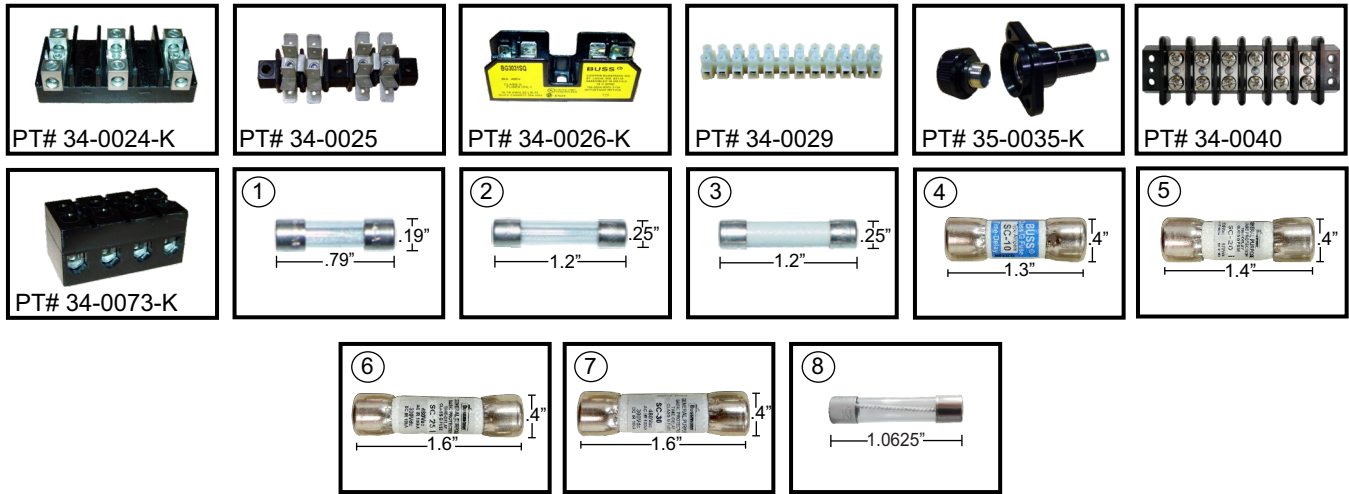

## PART NUMBER

## DESCRIPTION

PART NUMBER	DESCRIPTION
34-0024-K	Terminal Block ,Input, 4-14 AWG
34-0025	Terminal Block ,12 Pin
34-0026-K	Fuse Block, 30A, Main
34-0029	Terminal Block, 8000, 12 POS
35-0035-K	Fuse Holder, Panel mount
34-0040	Terminal Strip, Balboa, M1/M3, 6 POS
34-0073-K	Terminal Block , Marathon, 4 POS
① 35-0059	Fuse, 1A, 3AG, Fast Blo
① 35-0079-K	Fuse, 2AMP, 250VAC, SSPA Light
② 35-0064-K	Fuse, 250mA (1/4A), 3AG, Fast, Y5 Series, 3W System
② 35-0027-K	Fuse, 300mA (3/10A), 250V, VS, System, 5-Pack
② 35-21581-K	Fuse, 300mA (3/10A), 250V, VS, System, 5-Pack, BWG# 21581
① 35-0074-K	Fuse, 750mA (3/4A), 250V, SSPA, System
① 35-0074A-K	Fuse, 500mA (1/2A), 250V, SSPA, System
② 35-0074B	Fuse, 500mA (1/2A), 250V, Fast Blo, Y-3/5 Series, Systems (glass)
② 35-0020	Fuse, 3A, 3AG, Slow Blo, 600W, 240V
② 35-0020A	Fuse, 3A, 3AG, Fast, Light, VS
② 35-0021	Fuse, 4A, 3AG, Slow Blo
② 35-0024	Fuse, 12A, 3AG, Slow Blo
② 35-0032-K	Fuse, 8A, 3AG, Slow Blo, 800W, 120V
② 35-0060-K	Fuse, 2A, 3AG, Fast Blo
② 35-0061	Fuse, 5A, 3AG, Slow Blo, 800W, 240V
③ 35-0047-K	Fuse, 15A, Time Delay
③ 35-0047A-K	Fuse, 20A, Time Delay MDA-20A
③ 35-0062-K	Fuse, 10AMP 3AG, Slow Blo, Blower
④ 35-0066-K	Fuse, 10AMP, SC-10
③ 35-0080	Fuse, 5AMP Time Delay, 250VAC
③ 35-0081-K	Fuse, 10AMP Time Delay, 250VAC
④ 35-0067-K	Fuse, 15AMP, SC-15
⑤ 35-0058-K	Fuse, 20AMP, Main, SC-20
⑦ 35-0019-K	Fuse, 30A, Main, SC-30
⑥ 35-0063-K	Fuse, 25AMP, Main, SC-25
⑧ 35-0022	Fuse, 6.25A, 3AG, Slow Blo, Blower, 600W, 120V

## Tailpieces - 1.5" Heaters



**42-0015-K  
Tailpiece**  
1.5" MBT x 1.5" Soc



**42-0015D-K  
Tailpiece**  
1.5" MBT x 1.5" Spig



**42-0023-K  
Tailpiece**  
1.5" MBT x 1.25" Soc

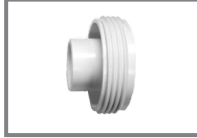

**42-0031-A-K  
Tailpiece**  
1.5" MBT x 1" Spig



**42-0031-K  
Tailpiece**  
1.5" MBT x 1" Soc



**42-0031F-K  
Tailpiece Offset**  
1.5" MBT x 1" Soc



**42-0031F-A-K  
Tailpiece Offset**  
1.5" MBT x 1" Spig



**42-0015C-K  
Tailpiece Offset**  
1" Spig x 32 mm



**42-0015A-K  
Tailpiece**  
1.5" MBT x 50mm Soc

## Tailpieces - 2" Heaters



**42-0006A-K  
Tailpiece**  
2" MBT x 2" Soc Short



**42-0017A-K  
Tailpiece**  
2" MBT x 2" Spig Short



**42-0017-K  
Tailpiece**  
2" MBT x 2" Spig/1.5" Soc



**42-0016-K  
Tailpiece**  
2" MBT x 1.5" Soc



**42-0006-T-K  
Tailpiece**  
2" MBT x 2" No Groove

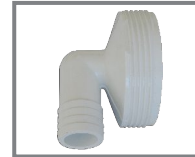

**42-2387-K  
Tailpiece**  
2" MBT x 1" 90° barb



**42-2391-K  
Tailpiece**  
2" MBT x .75" 90° barb

## Tailpieces - 3" Heaters



**42-2373-K  
Tailpiece**  
3" MBT x 2" Soc



**42-2384-K  
Tailpiece**  
3" MBT x .75" straight barb



**42-2390-K  
Tailpiece**  
3" MBT x .75" 90° barb

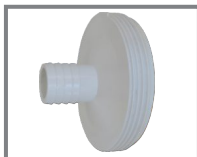

**42-2380-K  
Tailpiece**  
3" MBT x 1" straight barb



**42-2386-K  
Tailpiece**  
3" MBT x 1" 90° Barb



**42-2392-K  
Tailpiece**  
3" MBT x 1" 90° Soc

## Reducer Bushings



**42-0022-K  
Reducer Bushing**  
1" Spig x 0.75" FIPT



**42-0018-K  
Reducer Bushing**  
1" Spig x .75" Soc



**42-0001-K  
Reducer Bushing**  
2" Spig x 1.5" Spig x Soc

Parts

## Pump Unions

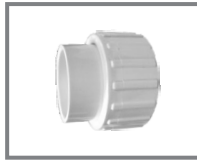

**42-0005-K**  
**Pump Union Half**  
1.5" x 1.5" Soc  
*Also sold as a pair:*  
PT# 48-0067-K



**42-0012-K**  
**Pump Union Half**  
2" x 1.5" Soc  
*Also sold as a pair:*  
PT# 48-0068-K



**42-0009-K**  
**Pump Union Half**  
2" x 2" Soc  
*Also sold as a pair:*  
PT# 48-0069-K

## Union Assemblies



**42-0011-K**  
**Union Assy**  
0.75" Soc x 0.75" Soc



**42-0011A-K**  
**Union Assy**  
1.0" Soc x 1.0" Soc



**42-0068-K**  
**Union Assy**  
2" Spig x 1.5" Soc

## Valves



**Ball Valve**  
**40-0008-K**  
1.5" x 1.5" Soc x Soc  
**40-0009-K**  
2" x 2" Soc x Soc  
**40-0010-K**  
0.75" x 0.75" Soc x Soc



**42-0056-K**  
**Check Valve**  
0.75" Soc x 0.75" Soc



**42-0078-K**  
**Check Valve**  
1.5" Soc x 1.5" Soc

## Elbows



**42-0087-K**  
**Elbow 90° Street**  
0.5" Spig x 0.5" Soc



**42-0049-K**  
**Elbow 90°**  
0.75" Soc x 0.75" Soc



**42-0003A-K**  
**Elbow 90°**  
1.5" Soc x 1.5" Soc



**42-0003-K**  
**Elbow 90° Street**  
1.5" Slip x 1.5" Spig



**42-0024A-K**  
**Elbow 90° Street w/T-Well**  
1.5" Soc x 1.5" Spig



**42-0085-K**  
**Elbow 90°**  
2" Soc x 2" Soc



**42-0002-K**  
**Elbow 90° Street**  
2" Spig x 2" Soc



**42-0002A-K**  
**Elbow 90°**  
2" Spig x 2" Spig



**42-0073-K**  
**Elbow 45°**  
2" Spig x 2" Soc



**42-0002-T-K**  
**Elbow 90° Street**  
2" Soc x 2" Spig  
x 0.5" FPT



**42-0037-K**  
**Elbow 90° w/T-well**  
2" Soc x 2" Spig  
5/16" x 4" T-well  
Air Bleed Valve



**42-0086-K**  
**Elbow 90°, Sweep**  
2" Soc x 2" Pump Union  
Half

## Adapters



**48-0072-K**  
**Adapter/Tailpiece**  
1.5" x Female Hose  
Bib











**48-0072A-K**  
**Adapter/Tailpiece**  
1.5" x Female Hose  
Bib



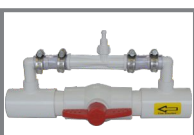

**42-0013-K**  
**Barb Adapter**  
0.75" x 1"

## Tees, Fittings, Misc PVC Parts

	<b>42-0047-K Tee</b> 2" Soc x 2" Soc x 0.5" FPT		<b>42-0047-T-K Tee</b> 2" MBT x 2" Spig x 0.5" FPT		<b>42-0117-K Tee</b> 1.5" SLP x 1.5" SLP x 1.5" SLP
	<b>42-0004-K Hi-Flo Suction</b> 1.5" Soc		<b>42-0074A-K Drain Wall Fitting w/Grate Assy</b> 1.5" FBT x 1.5" Soc		<b>42-0074-K Auto-Fill Wall Fitting, Slotted Return</b>
	<b>42-0116-K Ozone Manifold</b> 1.5" Soc x 1.5" Soc		<b>42-0088-K Coupling</b> 0.5" Soc x 0.5" Soc		<b>42-0022B-K Coupling</b> 1.5" Soc x 1.5" Soc
	<b>03 Manifold Kit</b> 49-0420A-K - 1 1/2" 49-0421-K - 2" 49-0422-K - 2 1/2"				

## Nuts, Gaskets

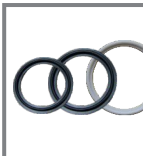
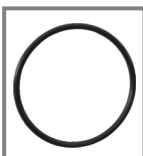
	<b>Split Nut w/Screws</b> <i>Sold in pairs:</i> 48-0082-K - 1.5" 48-0096-K - 2"		<b>Uni-Nut w/ Retainer</b> <i>Sold in pairs:</i> 42-2334-K - 1.5" 42-2334A-K - 2" 42-2334B-K - 3"		<b>Snap Nuts</b> <i>Sold in pairs:</i> 48-0074-K - 1.5" 48-0095-K - 2"		<b>Ridged Gaskets</b> 60-0017-K - 1.5" 60-0015-K - 2" 60-0020-K - 3"
	<b>60-0001-K O-Ring</b> Heater, 5X5 Flanged						

## Wood Hot Tub Fittings and Accessories

	<b>42-10-5300BRN Hydro-Jet Assy</b> 1.5" x 1.5" Hole Size - 2 3/8"		<b>42-10-5470BRN Slimline Jet Assy</b> 1" x 1" Hole Size - 1 11/16"		<b>42-10-5671BRN Slimline Jet Assy</b> 1" x 0.5" Hole Size - 1 11/16"
	<b>42-50-221XBRN Air Control</b> 1/2"		<b>42-30-3803BRN Wall Fitting</b> Hole Size - 1 11/16"		<b>42-10-6530BRN Strip Skimmer</b> Hole Size - 1 11/16"
	<b>42-4HP102X Suction Fitting</b> Hole Size: 2 3/8"		<b>42-30-6103 Elbow 90°</b> 1.5" Soc		<b>42-30-6104 Slimline Straight Nut</b>
	<b>42-30-3807 Standard Nut</b>		<b>25-0002-LG Front Access Wall Fitting Light Kit</b>		

Parts



## PART NUMBER

## DESCRIPTION

PART NUMBER	DESCRIPTION
	<b>Laing Pump</b>
10-0126-K	Laing Circ, E-3, .5" Barbed, 100-240V, 50/60HZ, Watkins®, 70" Cord w/Nema Plug
10-0127-K	Laing Circ, E-3, <b>Obsolete, Replaced by PT# 10-0102-K</b>
10-0102-K	Laing Circ, E-5, .75" Barbed, 100-240V, 50/60HZ, Watkins®, 48" Cord, 74427
10-0120-K	Laing Circ, E-10, .75" Barbed, 120V, 50/60HZ, 48" Cord, 73989
10-0120M-K	Laing Circ, E-10, .75" Barbed, 120V, 50/60HZ, 48" Cord, Sundance 6500-460
10-0121-K	Laing Circ, E-10, .75" Barbed, 240V, 50/60HZ, 48" Cord, 73979
10-0121M-K	Laing Circ, E-10, .75" Barbed, 240V, 50/60HZ, 48" Cord, Sundance 6000-125
10-0121F-K	Laing Circ, E-10, .75" Barbed, 240V, 50/60HZ, 19" Cord, Flow Control, D1
10-0121-A-K	Laing Circ, E-10, .75" Barbed, 240V, 50/60HZ, 19" Cord, w/o Flow Control, D1
10-0122-K	Laing Circ, E-10, 1" Barbed, 120V, 50/60HZ, 48" Cord, 74069
10-0123-K	Laing Circ, E-10, 1" Barbed, 240V, 50/60HZ, 48" Cord, 74079
10-0124-K	Laing Circ, E-10, .75" Threaded, 120V, 50/60HZ (not shown), 48" Cord, 74009
10-0125-K	Laing Circ, E-10, .75" Threaded, 240V, 50/60HZ (not shown), 48" Cord, 73999
10-0107-K	Laing Circ, E-14, 1.5" Threaded, 240V, 50/60HZ, 48" Cord, 73348
	<b>Grundfos Pump</b>
10-0134	Pump, Grundfos Circ, Series 43, 115V, 60Hz, 1" Barbed, 59896291*
10-0135	Pump, Grundfos Circ, Series 43, 230V, 60Hz, 1" Barbed, 59896292*
10-0136-K	Pump, Grundfos Circ, 115V, 60Hz, .75"X1" Barbed, Universal Kit
10-0137-K	Pump, Grundfos Circ, 230V, 60Hz, .75"X1" Barbed, Universal Kit
	<b>Iron Might Pump (1.5" Suction / 1.5" Discharge)</b>
10-0110	Pump, Iron Might, 120V, 60Hz, Side Discharge
10-0110A	Pump, Iron Might, 240V, 60Hz, Side Discharge
	<b>Tiny Might Pump (1" Suction / 1" Discharge)</b>
10-0111	Pump, Tiny Might, 120V 50/60Hz, Side Discharge
10-0111A	Pump, Tiny Might, 240V, 50/60Hz, Side Discharge
	<b>Inline Strainer</b>
10-0093	Filter, Inline Strainer, 3/4" Barb

\* Also replaces Series 38





Parts

PART NUMBER	DESCRIPTION
<b>48 Frame Spa Pump (2" Suction / 2" Discharge)</b>	
10-0215-3M	Pump, 1.0HP, 2SPD, 120V, 8.8/2.6A, 60Hz, Side Discharge
10-0207	Pump, 1.5HP, 1SPD, 230V, 7.5A, 60Hz, Side Discharge
10-0203-3M	Pump, 1.5HP, 2SPD, 115V, 11/2.9A, 60Hz, Side Discharge
10-0206	Pump, 2.0HP, 1SPD, 120/230V, 20/10A, 60Hz, Side Discharge
10-0204-3M	Pump, 2.0HP, 2SPD, 115V, 13.8/3.8, 60Hz, Side Discharge
10-0202-3M	Pump, 2.0HP, 2SPD, 230V, 8/2.6A, 60Hz, Side Discharge
10-0205	Pump, 3.0HP, 1SPD, 230V, 12A, 60Hz, Side Discharge
10-0201-3M	Pump, 3.0HP, 2SPD, 230V, 8.5/2.6A, 60Hz, Side Discharge
10-0200-3M	Pump, 4.0HP, 2SPD, 230V, 10.5/2.8A, 60Hz, Side Discharge
10-0210-3M	Pump, 5.0HP, 2SPD, 230V, 12/3.5A, 60Hz, Side Discharge
<b>56 Frame Executive Pump (2" Suction / 2" Discharge)</b>	
10-0220	Pump, 4.0HP, 56 Frame, 2SPD, 230V, 12/4.4A, 60Hz, Side Discharge
10-0221	Pump, 5.0HP, 56 Frame, 2SPD, 230V, 16/4.8A, 60Hz, Side Discharge
<b>56 Frame Self Priming Pump (2" Suction / 2" Discharge)</b>	
11-0003	Pump, 1.5HP, 2SPD, 230V, Self Priming
11-0002	Pump, 2.0HP, 2SPD, 230V, Self Priming
<b>Bath Pump, Full Drain (1.5" Suction / 1.5" Discharge)</b>	
10-0262A	Pump, Full Drain, 1/2HP, 1SPD, 120V, 3' cord w/Nema, 3Pt Mount
48-0067-K	Pump Union, Pair, 1.5"X1.5"
<b>Submersible Pump</b>	
10-0178-S	Pump, Submersible, 1/6HP, 120V
<b>Baptistry Pump (1.5" Suction / 1.5" Discharge)*</b>	
993-0262A-L48-S	Pump, 120V, 1SPD, 1/2HP, 48" Molded Cord
993-0380-A6-S	Pump, 115V, 1SPD, Amp Pigtail Cord
993-0380A-A6-S	Pump, 230V, 1SPD, Amp Pigtail Cord
<b>Leaf Trap</b>	
42-0070A-K	Pump, Leaf Trap, 1.5"X1.5", Kit
42-0070-K	Pump, Leaf Trap, 2"X2", Kit

\*See page 8.50 for a full list of Baptismal Pumps

### Ultima



### Ultima Plus



### Ultimax



### Dura Jet



#### Wet End Features:

- Viton Seal
- Individually Boxed
- Assembly Instructions Included
- Union O-Rings Provided



## Ultima

HQ PT#	BWG PT#	HP	SIZE	DISCHARGE	FRAME	MIN AMPERAGE*	
						120V	240V
10-0162-HQ	1215156	.75	1.5"S x 1.5"D	SIDE	48Y	9+	N/A
10-0163-HQ	1215158	.75	1.5"S x 1.5"D	CENTER	48Y	9+	N/A
10-0164-HQ	1215116	1.0	1.5"S x 1.5"D	SIDE	48Y	10.3+	N/A
10-0165-HQ	1215009/1215117	1.0	2"S x 2"D	SIDE	48Y	10.3+	N/A
10-0166-HQ	1215119	1.0	1.5"S x 1.5"D	CENTER	48Y	10.3+	N/A
10-0167-HQ	1215120/1215121	1.5	1.5"S x 1.5"D	SIDE	48Y	13.6+	7+
10-0168-HQ	1215123	1.5	2"S x 2"D	SIDE	48Y	13.6+	7+
10-0169-HQ	1215128	1.5	1.5"S x 1.5"D	CENTER	48Y	13.6+	7+
10-0170-HQ	1215129	2.0	1.5"S x 1.5"D	SIDE	48Y	N/A	8.0+
10-0171-HQ	N/A	1.5	2"S x 2"D	CENTER	48Y	13.6+	7+
10-0172-HQ	1215132	2.0	2"S x 2"D	SIDE	48Y	N/A	8.0+
10-0173-HQ	1215131	2.0	2"S x 1.5"D	SIDE	48Y	N/A	8.0+
10-0174-HQ	N/A	2.0	2"S x 1.5"D	CENTER	48Y	N/A	8.0+
10-0175-HQ	N/A	2.0	2"S x 2"D	CENTER	48Y	N/A	8.0+
10-0176-HQ	1215129	2.0	1.5"S x 1.5"D	CENTER	48Y	N/A	8.0+

## Ultima Plus

HQ PT#	BWG PT#	HP	SIZE	DISCHARGE	FRAME	MIN AMPERAGE*	
						120V	240V
10-0152-HQ	1215161	2.0	2"S x 2"D	SIDE	48Y	13.6+	7+
10-0153-HQ	1215145	3.0	2"S x 2"D	SIDE	48Y	N/A	8+

## Ultimax

HQ PT#	BWG PT#	HP	SIZE	DISCHARGE	FRAME	MIN AMPERAGE*	
						120V	240V
10-0181-HQ	N/A	1.5	2"S x 2"D	SIDE	15Y	N/A	6.7+
10-0182-HQ	1215010/1215160	1.5	2"S x 2"D	SIDE	48Y/56Y	N/A	6.7+
10-0183-HQ	1215185/1215055	2.0	2"S x 2"D	SIDE	48Y/56Y	N/A	8.8+
10-0185-HQ	N/A	2.5	2"S x 2"D	SIDE	48Y/56Y	N/A	10+
10-0186-HQ	1215186/1215060	3.0	2"S x 2"D	SIDE	48Y/56Y	N/A	12+
10-0187-HQ	1215036/1215062	3.0	2.5"S x 2"D	SIDE	48Y/56Y	N/A	12+
10-0188-HQ	1215007/1215187	4.0	2"S x 2"D	SIDE	48Y/56Y	N/A	16+
10-0189-HQ	1215045	4.0	2.5"S x 2"D	SIDE	48Y/56Y	N/A	16+

## Dura Jet

HQ PT#	BWG PT#	HP	SIZE	DISCHARGE	FRAME	MIN AMPERAGE*	
						120V	240V
10-0190-HQ	1215022	1.0	2"S x 2"D	SIDE	48Y/56Y	10.3+	5.5+
10-0192-HQ	1215023	1.5	2"S x 2"D	SIDE	48Y/56Y	13.6+	7+
10-0194-HQ	1215014	2.0	2"S x 2"D	SIDE	48Y/56Y	N/A	8+
10-0196-HQ	1215033	2.5	2"S x 2"D	SIDE	48Y/56Y	N/A	10+
10-0197-HQ	1215015	3.0	2"S x 2"D	SIDE	48Y/56Y	N/A	12+

S = Suction D = Discharge

\*MIN AMPERAGE: Some wet ends require the motor to have a minimum amperage rating. This is to avoid overheating the motor. The amperage rating of the motor can be read from the label on the motor showing amp draw for both low and high speed in the case of a two speed motor.

PARTS

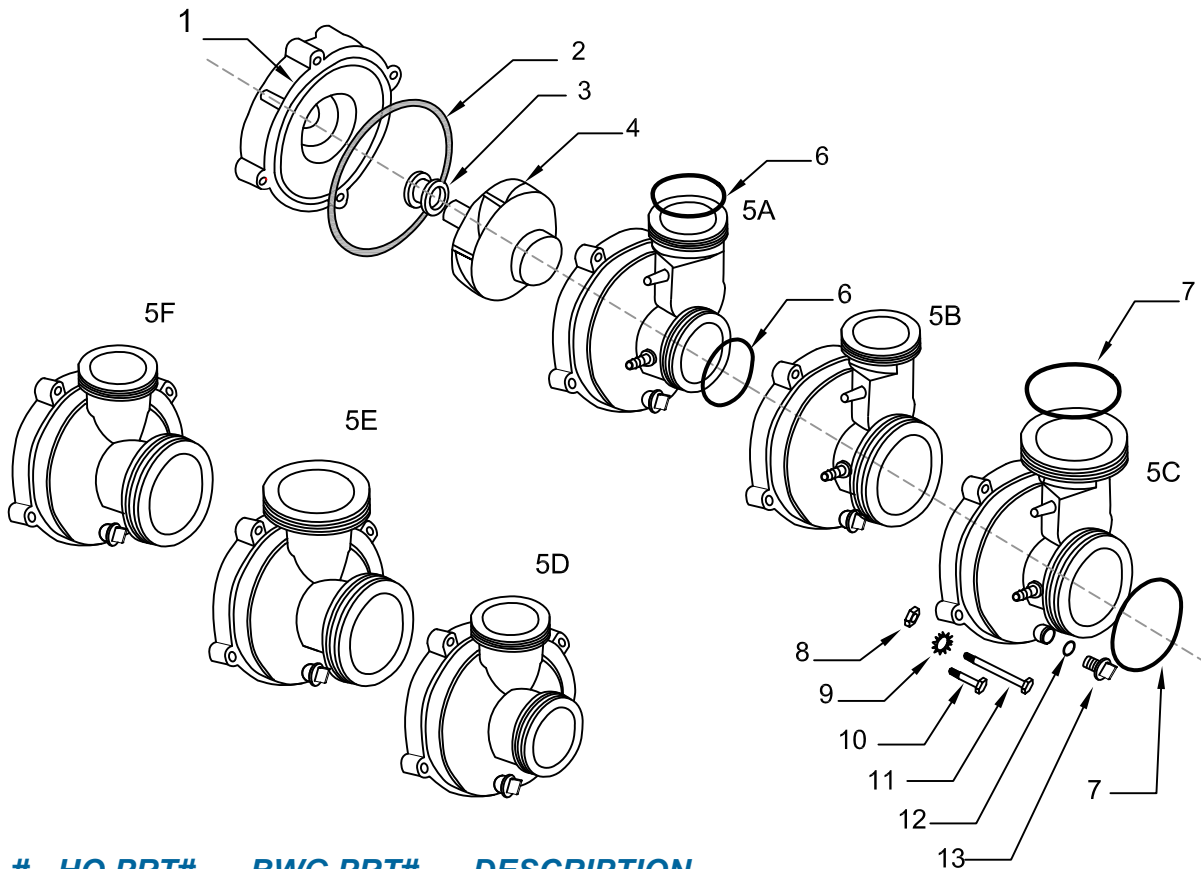

REF. #	HQ PRT#	BWG PRT#	DESCRIPTION
--------	---------	----------	-------------

1	15-0045A	1211008	Pump, Seal Plate
2	60-0010-K	6020022	O-Ring, Pump Volute, Ultima
3	10-0074A	N/A	Pump, Viton Seal Assy
4A	15-0059	1212120	Pump, Impeller 230V H/F Circ.
4C	15-0050	1212203	Pump, Impeller 3/4HP Ultima
4D	15-0051	1212205	Pump, Impeller 1.0HP Ultima
4E	15-0052	1212215	Pump, Impeller 1.5HP Ultima
4H	15-0053-K	1212218	Pump, Impeller 2.0HP Ultima
5A	15-0046	1210017	Pump, Volute 1.5"X1.5" Side
5B	15-0055	1210015	Pump, Volute 1.5"X2" Side
5C	15-0057	1210014	Pump, Volute 2"X2" Side
5D	15-0049	1210016	Pump, Volute 1.5"X1.5" Center
5E	15-0058	1210013	Pump, Volute 2"X2" Center
5F	15-0056	N/A	Pump, Volute 1.5"X2" Center
6	60-0005	N/A	O-Ring, 1.5" Pump Union
7	60-0011	N/A	O-Ring, 2" Pump Union
8	01-0005	N/A	Nut, 1/4-20 Hex Zinc
9	03-0017	N/A	Washer, 1/4" Star Zinc
10	02-0100	N/A	Bolt, 1/4-20 X 1.5", Zinc
11	02-0101	N/A	Bolt, 1/4-20 X 2.75", Zinc
12	60-0010C	0-112B70	O-Ring, Drain Plug
13	15-0036A	1214138	Plug, Pump Volute

### Ultima Wet End Assemblies

Part #	Description
10-0162-HQ	0.75HP, 1.5"X1.5" Side
10-0163-HQ	0.75HP, 1.5"X1.5" Center
10-0164-HQ	1.0HP, 1.5"X1.5" Side
10-0165-HQ	1.0HP, 2"X2" Side
10-0166-HQ	1.0HP, 1.5"X1.5" Center
10-0167-HQ	1.5HP, 1.5"X1.5" Side
10-0168-HQ	1.5HP, 2"X2" Side
10-0169-HQ	1.5HP, 1.5"X1.5" Center
10-0170-HQ	2HP, 1.5"X1.5" Side
10-0171-HQ	1.5HP, 2"X2" Center
10-0172-HQ	2HP, 2"X2" Side
10-0173-HQ	2HP, 1.5"X2" Side
10-0174-HQ	2HP, 1.5"X2" Center
10-0175-HQ	2HP, 2"X2" Center
10-0176-HQ	2HP, 1.5"X1.5" Center

Please refer to page 8.30 for a complete list of Wet Ends

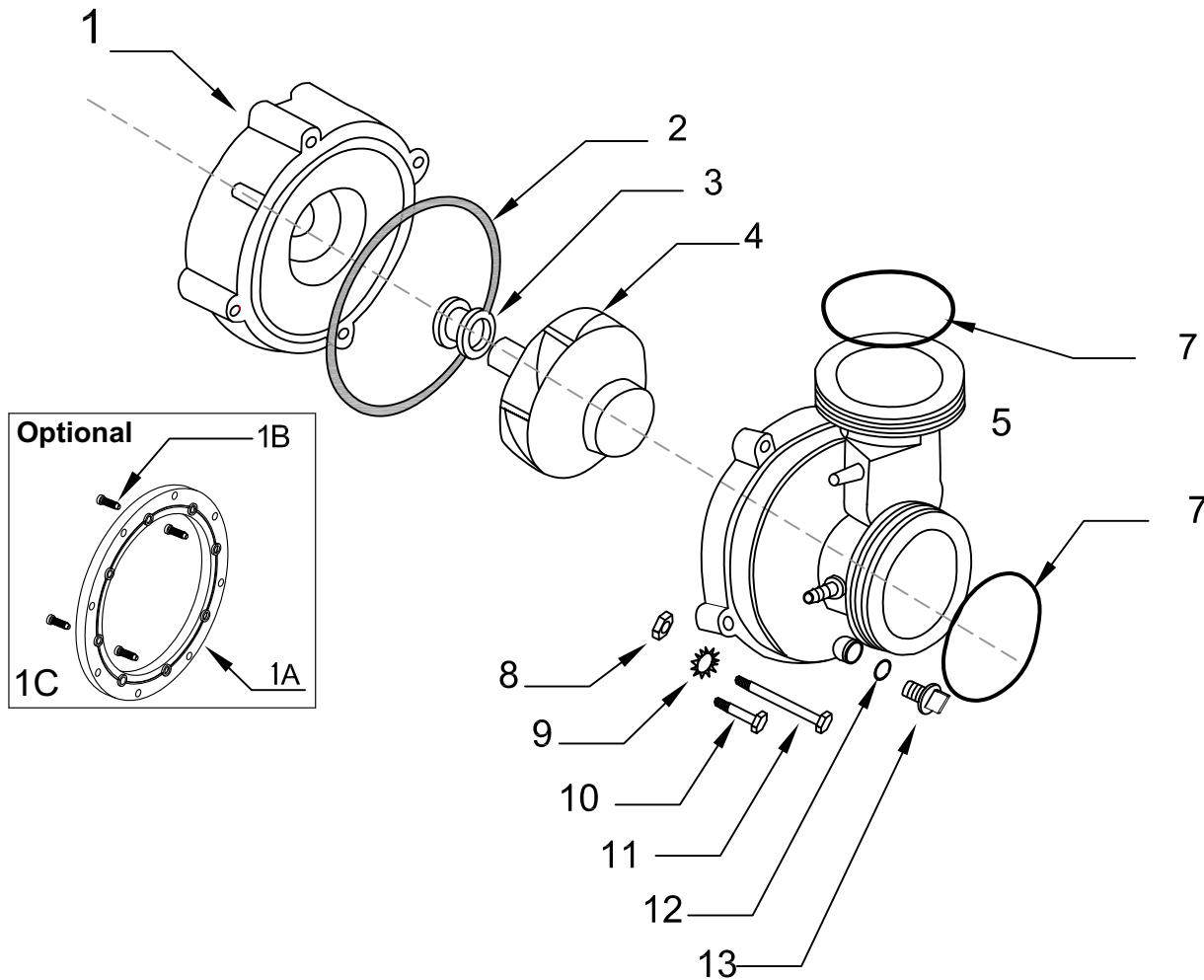

**Parts**

REF. #	HQ PRT#	BWG PRT#	DESCRIPTION
1	15-0061A	1211009	Pump, Seal Plate No Seal, Ultima Plus
1A	15-0089	1217179	Bracket, Pump GE MTR, 48/56F (not included)
1B	02-0053A	N/A	Machine Screw, 8-32 x 3/8", Stainless Steel
1C	48-0202-K	N/A	BWG Pump Bracket w/hardware, Kit
2	60-0010-K	6020022	O-Ring, Pump Volute
3	10-0074A	N/A	Pump, Viton Seal Assy
4A	15-0052C	1212185	Pump, Impeller 1.5HP Ultima Plus
4D	15-0053C	1212225	Pump, Impeller 2.0HP Ultima Plus
4E	15-0060C-K	1212221	Pump, Impeller 3.0HP Ultima Plus
5	15-0062	1210036	Pump, Volute 2"X2" Side Ultima Plus
7	60-0011	N/A	O-Ring, 2" Pump Union
8	01-0005	N/A	Nut, 1/4-20 Hex Zinc
9	03-0017	N/A	Washer, 1/4" Star Zinc
10	02-0100	N/A	Bolt, 1/4-20 X 1.50", Zinc
11	02-0101	N/A	Bolt, 1/4-20 X 2.75", Zinc
12	60-0010C	0-112B70	O-Ring, Drain Plug
13	15-0036A	1214138	Plug, Pump Volute

**Ultima Plus Wet End Assemblies**

Part #	Description
10-0152-HQ	2.0HP, 2"X2" Side
10-0153-HQ	3.0HP, 2"X2" Side

Please refer to page 8.30 for a complete list of Wet Ends

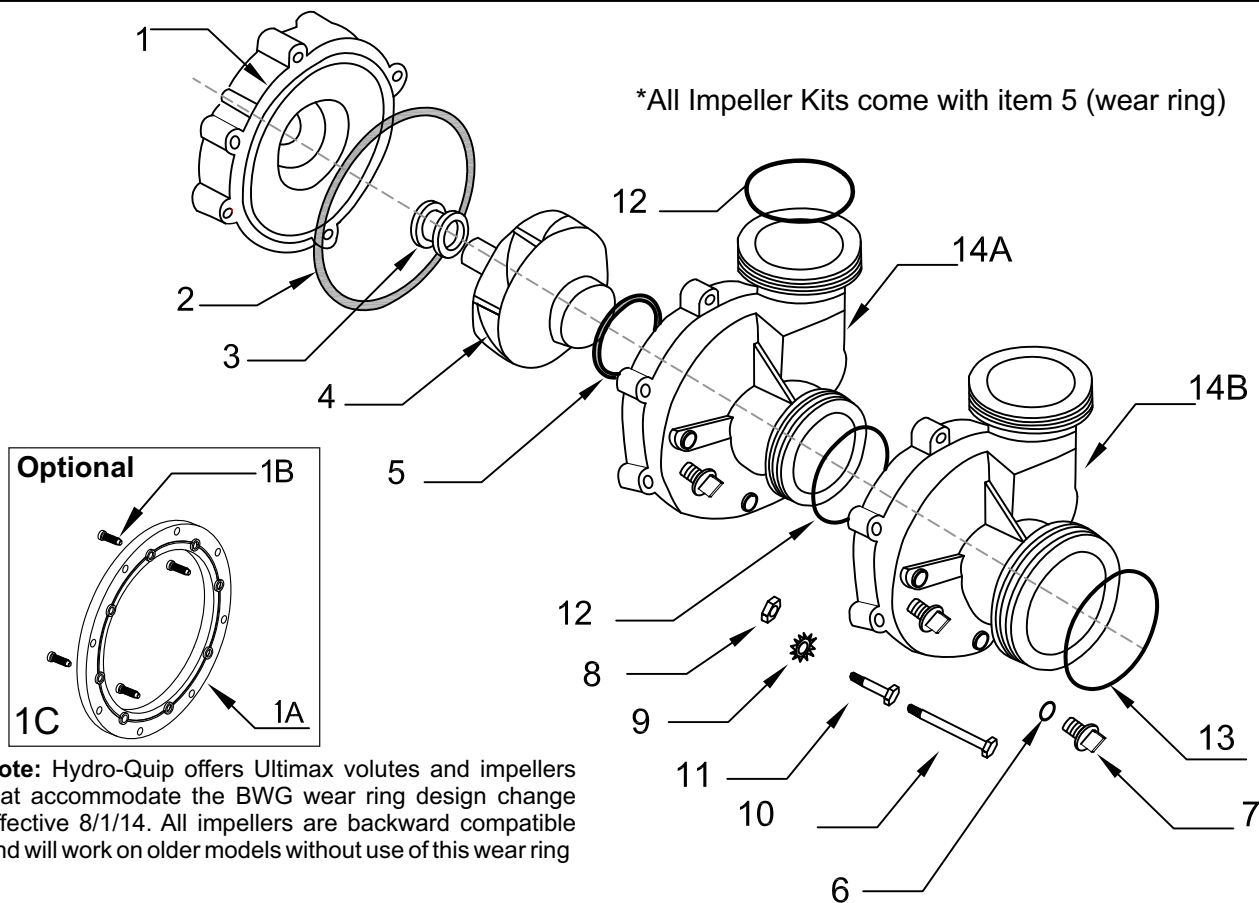

**Note:** Hydro-Quip offers Ultimax volutes and impellers that accommodate the BWG wear ring design change effective 8/1/14. All impellers are backward compatible and will work on older models without use of this wear ring

Parts

REF. #	HQ PRT#	BWG PRT#	DESCRIPTION
1	15-0067	1211027	Pump, Back Seal Plate Ultimax
1A	15-0089	1217179	Bracket, Pump GE MTR, 48/56F (not included)
1B	02-0053A	N/A	Machine Screw, 8-32 x 3/8", Stainless Steel
1C	48-0202-K	N/A	BWG Pump Bracket w/hardware, Kit
2	60-0010A-K	0-163E70	O-Ring, Pump Volute Ultimax
3	10-0074A	N/A	Pump, Viton Seal
4A*	15-0052B1-K	1212227/1212350	Pump, Impeller 1.0HP Ultimax, Power Wow
4B*	15-0052B-K	1212223/1212243	Pump, Impeller 1.5HP Ultimax
4C*	15-0053B-K	1212230/1212354	Pump, Impeller 2.0HP Ultimax
4D*	15-0054B-K	1212355	Pump, Impeller 2.5HP Ultimax
4E*	15-0060B-K	1212234/1212235/ 1212360	Pump, Impeller 3.0HP Ultimax
4F*	15-0064B-K	1212008/1212375	Pump, Impeller 4.0HP Ultimax
5	15-0066	1213050	Pump, Wear Ring Ultimax
6	60-0010C	0-112B70	Pump, O'Ring Drain Plug
7	15-0036A	1214138/1214140	Pump, Plug Volute Ultimax
8	01-0005	N/A	Nut, 1/4-20 Hex, Zinc
9	03-0017	N/A	Washer, 1/4" Star Zinc
10	02-0101	N/A	Bolt, 1/4-20 -2.75", Zinc
11	02-0100	N/A	Bolt, 1/4-20 -1.5", Zinc
12	60-0011	N/A	O-Ring, 2" Pump Union
13	60-0011A	0-234B70	O-Ring, 2.5" Pump Union
14A	15-0068	1210050	Pump, Volute 2"X2" Suction
14B	15-0068A	1210051	Pump, Volute 2"X2.5" Suction

**Ultimax Plus Wet End Assemblies**

Part #	Description
10-0181-HQ	1.5HP, 2"X2" Side, Power Wow
10-0182-HQ	1.5HP, 2"X2" Side
10-0183-HQ	2.0HP, 2"X2" Side
10-0185-HQ	2.5HP, 2"X2" Side
10-0186-HQ	3.0HP, 2"X2" Side
10-0187-HQ	3.0HP, 2"X2.5" Side
10-0188-HQ	4.0HP, 2"X2" Side
10-0189-HQ	4.0HP, 2"X2.5" Side

Please refer to page 8.30 for a complete list of Wet Ends

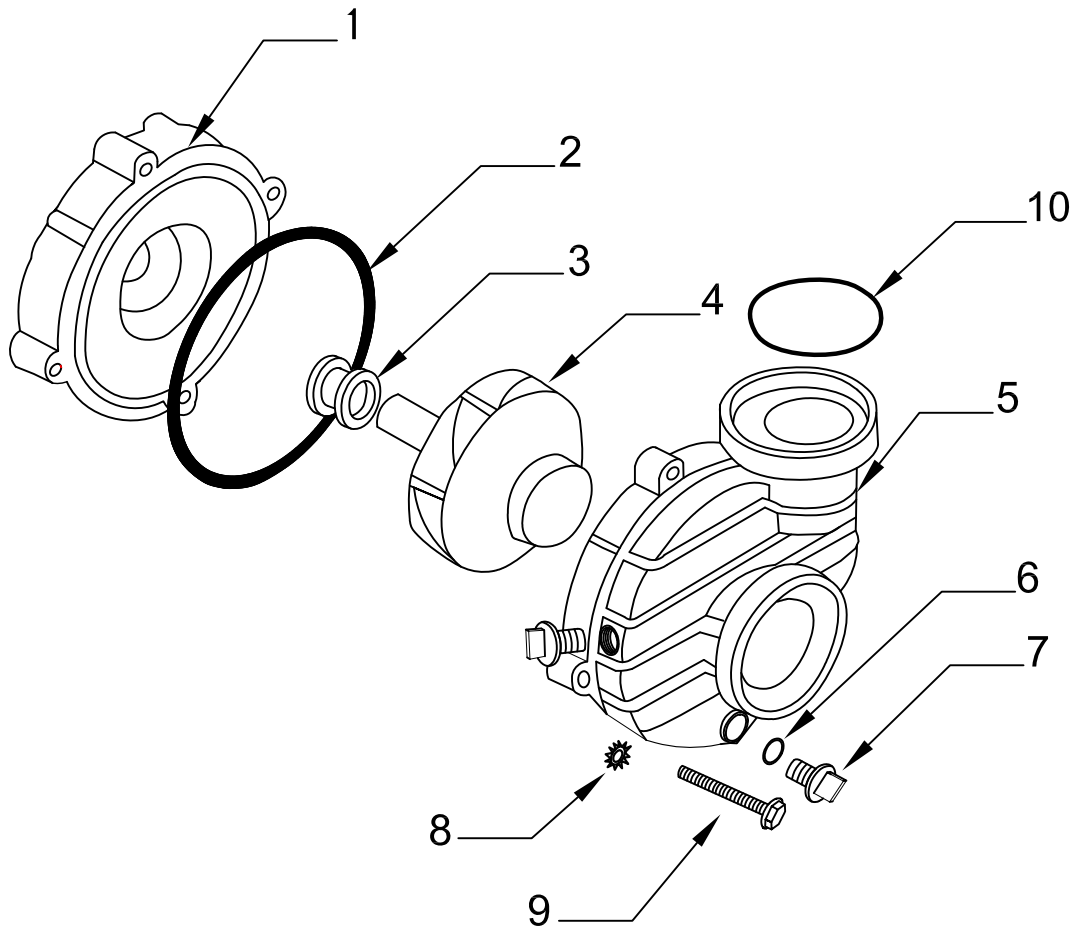

**Parts**

REF. #	HQ PRT#	BWG PRT#	DESCRIPTION
1	15-0044A	17400-0003	Pump Seal Plate With Nuts
2	60-0010B-K	6020026	O-Ring, Volute DJ
3	10-0074A	N/A	Pump, Viton Seal Assy
4A	15-0051A	17400-0120	Pump Impeller 1.0 HP
4C	15-0052A	17400-0121	Pump Impeller 1.5 HP
4E	15-0053A	17400-0122	Pump Impeller 2.0 HP
4F	15-0054A	17400-0123	Pump Impeller 2.5 HP
4G	15-0060A-K	17400-0135	Pump Impeller 3.0 HP
5	15-0043	17400-0108	Pump, Volute 2"x2" Side
6	60-0010C	0-112B70	O-Ring, Drain Plug
7	15-0036A	1214138	Plug, Pump Volute
8	03-0017	N/A	Washer 1/4" Star Zinc
9	02-0100	N/A	Bolt, 1/4-20 -1.5 Hex Head, Zinc
10	60-0011	N/A	O-Ring 2" Pump Union

**Dura Jet Wet End Assemblies**

Part #	Description
10-0190-HQ	1.0HP, 2"x2" Side
10-0192-HQ	1.5HP, 2"x2" Side
10-0194-HQ	2.0HP, 2"x2" Side
10-0196-HQ	2.5HP, 2"x2" Side
10-0197-HQ	3.0HP, 2"x2" Side

*Please refer to page 8.30 for a complete list of Wet Ends*

# Replacement Heater Assemblies

## ACC, Acura, Brett

Flo-Thru heater assembly, 2.25" x 15", 304SS, PSI tap, with cover plate and studs. Includes 2"x2" tailpieces, 2" ridged gaskets.



### Incoloy Element

26-0314-7S-K - 5.5kW/240V  
26-0314-5S-K - 4.0kW/240V

### Titanium Element

26-0314-7T-K - 5.5kW/240V  
26-0314-5T-K - 4.0kW/240V

## ACC

Flo-Thru heater assembly, 2.25" x 12", 304SS, PSI tap, with cover plate and studs. Includes 2"x2" tailpieces, 2" ridged gaskets.



### Incoloy Element

26-1004-7S-K - 5.5kW/240V

### Titanium Element

26-1004-7T-K - 5.5kW/240V

## Arctic Spas

Flo-Thru heater assembly, 2.25" x 12", 316L, PSI tap, with cover plate and power cords. Includes 2"x2" tailpieces, 2" ridged gaskets.



### Titanium Element

48-9120-7P-K - 5.5kW/240V  
48-9150-5P-K - 4.0kW/240V  
48-9151-AP-K - 3.6kW/240V

## Arctic Spas

"L" Shape heater assembly, 2.25" x 12.7", 304SS, PSI tap, with cover plate and power cord. Includes 2"x2" tailpieces, 2" ridged gaskets.



### Incoloy Element

48-9121-7S-K - 5.5kW/240V

### Titanium Element

48-9122-AT-K - 3.6kW/240V

## Arctic Spas

"L" Shape heater assembly, 2.25" x 9", PSI tap, with cover plate and power cords. Includes 45° elbow, 2"x2" tailpieces, 2" ridged gaskets.



### Titanium Element

48-9123-7T-K - 5.5kW/240V, 304SS  
48-9124-AP-K - 3.6kW/240V, 316L

## Arctic Spas

Flo-Thru heater assembly, 2.25" x 15", 304SS, PSI tap, with cover plate and power cord. Includes 2"x2" tailpieces, 2" ridged gaskets.



### Titanium Element

48-9125-5T-K - 4.0kW/240V

## Arctic Spas

Flo-Thru heater assembly, 2.25" x 19.25", 316L, Dual element, PSI tap, with cover plate and power cord. Includes 2"x2" tailpieces, 2" ridged gaskets.



### Titanium Element

48-9130-CP-K - 7.2kW/240V

## Apollo Spas

Flo-Thru heater assembly, 2.25", 316L, PSI tap, with cover plate and power cords. Includes 2"x2" tailpieces, 2" ridged gaskets.

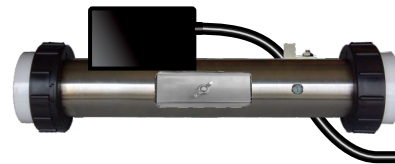

### Incoloy Element

26-H0136-6S-K - 2.25"x15" - 4.5kW/240V

## Balboa®

Flo-Thru heater assembly, 2.25" x 15", 304SS, two PSI taps, with cover plate. Includes 2"x2" tailpieces, 2" ridged gaskets.



### Incoloy Element

26-0035-7S-K - 5.5kW/240V

### Titanium Element

26-0035-7T-K - 5.5kW/240V

## Balboa®

Flo-Thru heater assembly, 2.25" x 15", 304SS, PSI tap, with cover plate. Includes 2"x2" tailpieces, 2" ridged gaskets.



### Incoloy Element

26-0535-7S-K - 5.5kW/240V  
26-0535-5S-K - 4.0kW/240V  
26-0535-4S-K - 3.0kW/240V

### Titanium Element

26-0535-7T-K - 5.5kW/240V  
26-0535-5T-K - 4.0kW/240V

## Balboa®

Flo-Thru heater assembly, 2.25" x 15", 304SS, with PSI & guard, with cover plate. Includes 2"x2" tailpieces, 2" ridged gaskets.

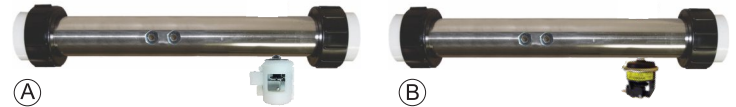

(A) = With PSI PT# 34-0153 w/guard (B) = With PSI PT# 34-0019-C no guard

### Incoloy Element

(A) 26-0535-7S-KP - 5.5kW/240V  
(A) 26-0535-5S-KP - 4.0kW/240V  
(B) 26-0535-7S-KP01 - 5.5kW/240V  
(B) 26-0535-5S-KP01 - 4.0kW/240V

### Titanium Element

(A) 26-0535-7T-KP - 5.5kW/240V  
(A) 26-0535-5T-KP - 4.0kW/240V

Parts

## Balboa®

Flo-Thru heater assembly, 2.25" x 15", 304SS, PSI tap, and sensor tap. Includes 2"x2" tailpieces, 2" ridged gaskets.



### Incoloy Element

26-0809-7S-K - 5.5kW/240V  
26-0809-5S-K - 4.0kW/240V

### Titanium Element

26-0809-7T-K - 5.5kW/240V  
26-0809-5T-K - 4.0kW/240V

## Balboa®

Flo-Thru heater assembly, 2.25" x 15", 304SS, with PSI switch w/guard, and sensor tap. Includes 2"x2" tailpieces, 2" ridged gaskets.



### Incoloy Element

26-0809-7S-KSP - 5.5kW/240V  
26-0809-5S-KSP - 4.0kW/240V

### Titanium Element

26-0809-7T-KSP - 5.5kW/240V  
26-0809-5T-KSP - 4.0kW/240V

## Cal Spas

Flo-Thru heater assembly, 2.25" x 16.25", 304SS, PSI tap, cover plate. Includes 2"x2" tailpieces, 2" ridged gaskets.



### Incoloy Element

26-0165-7S-K - 5.5kW/240V  
26-0165-5S-K - 4.0kW/240V  
26-0165-3S-K - 2.5kW/240V

### Titanium Element

26-0165-7T-K - 5.5kW/240V  
26-0165-5T-K - 4.0kW/240V  
26-0165-3T-K - 2.5kW/240V

## Cal Spas

Flo-Thru heater assembly, 2.25" x 15", 316SS, PSI tap, cover plate. Includes 1.5"x2" tailpieces with o-rings, 2" ridged gaskets.



### Incoloy Element

26-H0021-7S-K - 5.5kW/240V

## Cal Spas XL

Flo-Thru heater assembly, 2.25" x 15", 304SS, PSI tap, cover plate, with stud, insulated aluminum housing, heater wires w/connectors. Includes 2"x2" tailpieces, 2" ridged gaskets.



### Incoloy Element

26-0011-7S-K - 5.5kW/240V  
26-0011-5S-K - 4.0kW/240V  
26-0011-3S-K - 2.5kW/240V

### Titanium Element

26-0011-F-RS-K - 5.5kW/240V  
26-0011-F-PS-K - 4.0kW/240V

## Cal Spas

Flo-Thru heater assembly, 2.25" x 15", 304SS, heater wires w/connectors. Includes 2"x2" tailpieces, 2" ridged gaskets, w/Insulation wrap.



### Incoloy Element

26-2001-7S-K - 5.5kW/240V  
26-2001-5S-K - 4.0kW/240V  
26-2001-3S-K - 2.5kW/240V

### Titanium Element

26-2001-7T-K - 5.5kW/240V  
26-2001-5T-K - 4.0kW/240V  
26-2001-3T-K - 2.5kW/240V

All heater assemblies are available in 316L Stainless Steel Housings.

All heater assemblies come with tail pieces and gaskets

## Caldera

Flo-Thru heater assembly, 2.25" x 15", 304SS, PSI tap, ground strip, with mounting studs. Includes 2"x2" tailpieces, 2" ridged gaskets, and (2) heater wires.



### Incoloy Element

26-3330-5S-K - 4.0kW/240V

### Titanium Element

26-3330-5T-K - 4.0kW/240V

## Coates

Flo-Thru heater assembly, 2.25" x 15", 316L SS, PSI tap, cover plate, with studs. Includes 2"x2" tailpieces, 2" ridged gaskets



### Titanium Element

26-0517-MP-K - 5.5kW/240V  
26-0517-5P-K - 4.0kW/240V  
26-0517-4P-K - 3.0kW/240V

## Correct Tech

Flo-Thru heater assembly, 2.25" x 12.63", 304SS, PSI tap, with cover plate, and studs. Includes 2"x2" tailpieces, 2" ridged gaskets.



### Incoloy Element

26-2300-5S-K - 4.0kW/240V  
26-2300-4S-K - 3.0kW/240V  
26-2300-2S-K - 2.0kW/240V

### Titanium Element

26-2300-5T-K - 4.0kW/240V  
26-2300-4T-K - 3.0kW/240V  
26-2300-2T-K - 2.0kW/240V

## DM/Vita

Flo-Thru heater assembly, 2.25" x 15", 304SS, PSI tap, cover plate, with studs. Includes 2"x2" tailpieces, 2" ridged gaskets, and heater wires.



### Incoloy Element

26-0010-4S-K - 3.0kW/240V  
26-0010-6S-K - 4.5kW/240V

### Titanium Element

26-0010-4T-K - 3.0kW/240V  
26-0010-6T-K - 4.5kW/240V

## DM/Vita

Flo-Thru heater assembly, 2.25" x 15", 304SS, No PSI tap, cover plate, with studs. Includes 2"x2" tailpieces, 2" ridged gaskets, and heater wires.



### Incoloy Element

26-0024-4S-K - 3.0kW/240V

### Titanium Element

26-0024-4T-K - 3.0kW/240V

## DM/Vita

Flo-Thru heater assembly, 2.25" x 15", 304SS, No PSI tap, with studs. Includes 2"x2" tailpieces, 2" ridged gaskets, and heater wires.



### Incoloy Element

26-0028-5S-K - 4.0kW/240V  
26-0028-4S-K - 3.0kW/240V



# Replacement Heater Assemblies

## DM/Vita

Flo-Thru heater assembly, 2.25" x 17.75", 304SS, No PSI tap, cover plate, with studs. Includes 2"x2" tailpieces, 2" ridged gaskets, and heater wires.



### Incoloy Element

26-1008-7S-K - 5.5kW/240V  
26-1008-6S-K - 4.5kW/240V  
26-1008-4S-K - 3.0kW/240V

### Titanium Element

26-1008-7T-K - 5.5kW/240V  
26-1008-6T-K - 4.5kW/240V  
26-1008-4T-K - 4.5kW/240V

## Dimension One

Flo-Thru heater assembly, 2.25" x 12", 316L, with PSI tap, cover plate, and studs. Includes 2"x2" tailpieces, 2" ridged gaskets.



### Incoloy Element

26-0001-5S-K - 4.0kW/240V

## Gecko M Class

Flo-Thru heater assembly, 2.25" x 15", 304SS, PSI tap, with mounting studs. Includes 2"x2" tailpieces, 2" ridged gaskets.



### Incoloy Element

26-0601-7S-K - 5.5kW/240V  
26-0601-5S-K - 4.0kW/240V  
26-0601-3S-K - 2.5kW/240V  
26-0601-2S-K - 2.0kW/240V

### Titanium Element

26-0601-7T-K - 5.5kW/240V  
26-0601-5T-K - 4.0kW/240V  
26-0601-PT-K - 3.6kW/240V  
26-0601-3T-K - 2.5kW/240V  
26-0601-2T-K - 2.0kW/240V

## Gecko S Class/Caldera/Nordic

Flo-Thru heater assembly, 2.25" x 15", 304SS, PSI tap, with studs. Includes 2"x2" tailpieces, 2" ridged gaskets.

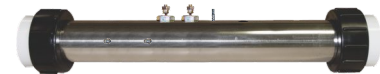

### Incoloy Element

26-0800-7S-K - 5.5kW/240V  
26-0800-5S-K - 4.0kW/240V  
N/A  
26-0800-4S-K - 3.0kW/240V  
26-0800-3S-K - 2.5kW/240V  
26-0800-2S-K - 2.0kW/240V

### Titanium Element

26-0800-7T-K - 5.5kW/240V  
26-0800-5T-K - 4.0kW/240V  
26-0800-AT-K - 3.6kW/240V  
26-0800-4T-K - 3.0kW/240V  
26-0800-3T-K - 2.5kW/240V  
26-0800-2T-K - 2.0kW/240V

## Gecko/Morgan

Flo-Thru heater assembly, 2.25" x 15", 304SS, PSI tap, cover plate, with studs. Includes 2"x2" tailpieces, 2" ridged gaskets.

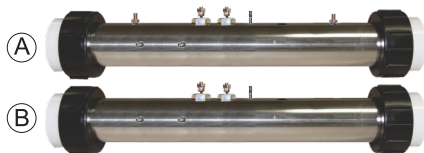

### Incoloy Element

(A) 26-0802-7S-K - 5.5kW/240V  
(A) 26-0802-6S-K - 4.5kW/240V  
(A) 26-0802-5S-K - 4.0kW/240V  
(B) 26-0802A-3S-K - 2.5kW/240V  
(B) 26-0802A-5S-K - 4.0kW/240V  
(B) 26-0802A-6S-K - 4.5kW/240V

### Titanium Element

(A) 26-0802-7T-K - 5.5kW/240V  
(A) 26-0802-6T-K - 4.5kW/240V  
(A) 26-0802-5T-K - 4.0kW/240V

## Hercules

Flo-Thru heater assembly, 2.25" x 15", 304SS, PSI tap, with cover plate, and studs. Includes 2"x2" tailpieces, 2" ridged gaskets.



### Incoloy Element

26-0315-5S-K - 4.0kW/240V

### Titanium Element

26-0315-5T-K - 4.0kW/240V

## Hercules

Flo-Thru heater assembly, 2.25" x 18", 304SS, PSI tap, with cover plate, and studs. Includes 2"x2" tailpieces, 2" ridged gaskets.



### Incoloy Element

26-0155-7S-K - 5.5kW/240V

## HQ / Therm Products

Flo-Thru heater assembly, 2.25" x 15", 304SS, no PSI tap, with cover plate. Includes 2"x2" tailpieces, 2" ridged gaskets.



### Incoloy Element

26-0309-4S-K - 3.0kW/240V  
26-0309-3S-K - 2.5kW/240V

## Hurricane Spas

Flo-Thru heater assembly, 2.25" x 15", 304SS, with PSI tap, thermo wells, and studs. Includes 2"x2" tailpieces, 2" ridged gaskets.



### Incoloy Element

26-0002-7S-K - 5.5kW/240V  
26-0002-4S-K - 3.0kW/240V  
26-0002-3S-K - 2.5kW/240V

## L.A. Spas / Advanced Spas

Flo-Thru heater assembly, 2.25" x 15", 304SS, PSI tap, with cover plate, and studs. Includes 2"x2" tailpieces, 2" ridged gaskets.



### Incoloy Element

26-0736-7S-K - 5.5kW/240V  
26-0736-3S-K - 2.5kW/240V

## Leisure Bay Spas

Flo-Thru heater assembly, 3" x 17.50", 304SS, PSI tap, with cover plate, and studs. Includes 3"x2" tailpieces, 3" ridged gaskets.

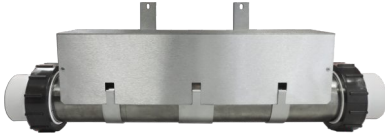

### Incoloy Element

26-1001-5S-K - 4.0kW/240V

## Marquis Spas

Flo-Thru heater assembly, 2.25" x 12", 304SS, PSI tap, with cover plate, and studs. Includes 2"x2" tailpieces, 2" ridged gaskets.



### Incoloy Element

26-C2278-1-5S-K - 4.0kW/240V

## Nuwave Spas

Flo-Thru heater assembly, 2.25" x 19.25"/15", 304SS, PSI tap, with cover plate, and studs. Includes 2"x2" tailpieces, 2" ridged gaskets.



### Incoloy Element

- Ⓐ 26-0213N-7S-K - 5.5kW/240V
- Ⓐ 26-0213N-5S-K - 4.0kW/240V
- Ⓐ 26-0213N-4S-K - 3.0kW/240V
- Ⓑ 26-0313N-5S-K - 4.0kW/240V
- Ⓑ 26-0313N-7S-K - 5.5kW/240V

## Saratoga

Flo-Thru heater assembly, 2.25" x 13.5", 304SS, PSI tap, with cover plate, studs. Includes 2"x 3/4" Barb, 90° elbow tailpieces, 2" ridged gaskets.



### Incoloy Element

26-H3037-5S-K - 4.0kW/240V

## Saratoga

Flo-Thru heater assembly, 3" x 13.5", 304SS, with junction box, cover plate and studs. Includes 2"x2" tailpieces, 2" ridged gaskets.



### Incoloy Element

26-0520-7T-K - 5.5kW/240V

## SBSG AP-1/LX-15

Flo-Thru heater assembly, 2.25" x 15", 304SS, PSI tap, with cover plate, and studs. Includes 2"x2" tailpieces, 2" ridged gaskets. SBSG/AP-1, LX-15



### Incoloy Element

- 26-0056-7S-K - 5.5kW/240V
- 26-0056-5S-K - 4.0kW/240V
- 26-0056-4S-K - 3.0kW/240V
- 26-0056-3S-K - 2.5kW/240V
- 26-0056-2S-K - 2.0kW/240V

### Titanium Element

- 26-0056-7T-K - 5.5kW/240V
- 26-0056-5T-K - 4.0kW/240V
- 26-0056-4T-K - 3.0kW/240V
- 26-0056-3T-K - 2.5kW/240V
- 26-0056-2T-K - 2.0kW/240V

## Sundance/SBSG AP-4/LX10

Flo-Thru heater assembly, 2.25" x 12", 304SS, PSI tap, with cover plate, and studs. Includes 2"x2" tailpieces, 2" ridged gaskets. SBSG/AP-4, LX-10



### Incoloy Element

- 26-1002-7S-K - 5.5kW/240V
- 26-1002-5S-K - 4.0kW/240V
- N/A
- 26-1002-4S-K - 3.0kW/240V
- 26-1002-3S-K - 2.5kW/240V

### Titanium Element

- 26-1002-7T-K - 5.5kW/240V
- 26-1002-5T-K - 4.0kW/240V
- 26-1002-AT-K - 3.6kW/240V
- 26-1002-4T-K - 3.0kW/240V
- 26-1002-3T-K - 2.5kW/240V

## Sundance

Flo-Thru heater assembly, 2.25" x 15", 304SS, PSI tap, with cover plate, and studs. Includes 2"x2" tailpieces, 2" ridged gaskets.



### Incoloy Element

26-0556-7S-K - 5.5kW/240V

### Titanium Element

26-0556-7T-K - 5.5kW/240V

## Sundance/Jacuzzi

Flo-Thru heater assembly, 2.25" x 15", 316L, junction box with hi-limit, 48" cord and studs. Includes stands, 2"x2" tailpieces, and 2" ridged gaskets.

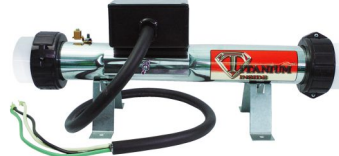

### Titanium Element

- 26-0316-MP-KB - 5.5kW/240V
- 26-0316-AP-KB - 3.6kW/240V

## Thermo Spas / Coleman

Flo-Thru heater assembly, 2.25" x 15", 304SS, no PSI tap, with cover plate. Includes 2"x2" tailpieces, 2" ridged gaskets.



### Incoloy Element

- 26-0739-7SD-K - 5.5kW/240V
- 26-0739-5SD-K - 4.0kW/240V

### Titanium Element

- 26-0739-7TD-K - 5.5kW/240V
- 26-0739-5TD-K - 4.0kW/240V

# Replacement Heater Assemblies

## Therm Products By HydroQuip

Flo-Thru heater assembly, 2.25" x 15", Thermostat, Hi-Limit, PSI Switch & 240V 3 Wire Connection. Includes 2"x2" tailpieces, 2" ridged gaskets.



**Incoloy Element**

**26-0000ABX-7S-K** - 5.5kW/240V

**Titanium Element**

**26-0000ABX-7T-K** - 5.5kW/240V

## Therm Products By HydroQuip

Flo-Thru heater assembly, 2.25" x 15", 304SS, Box cover over terminals, M7 taps, 40" 3 wire cord w/connectors. Includes 2"x2" tailpieces, 2" ridged gaskets.



**Incoloy Element**

**26-0814-7S-K** - 5.5kW/240V

**Titanium Element**

**26-0814-7T-K** - 5.5kW/240V

## Therm Products By HydroQuip

Double Barrel Heater Assembly with Auto-Reset High Limit, 55" Cord, Temp/HL Sensors, 3/4" Barb.

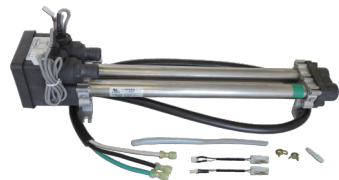

**Titanium Element**

**26-C3160-1S** - 6.0/1.5kW, 120/240V

**26-C3160-2S** - 4.0/1.0kW, 120/240V

**26-C3160-3S** - 3.0kW, 120/240V

**26-C3182-1S** - 1.5kW, 240V Export

**26-C3072-8T-F** - 6.0/1.5kW, 120/240V, w/Flow Switch

**26-C3072-5T-F** - 4.0/1.0kW, 120/240V, w/Flow Switch

**26-C3072-4T-F** - 3.0kW, 120/240V, w/Flow Switch

**26-C3073-1T-F** - 1.5kW, 240V Export, w/Flow Switch

## Double Barrel Heater Accessories



PT# 30-01395-K



PT# 34-01395-K



PT# 48-0041-K



PT# 48-0041A-K



PT# 48-0201



PT# 48-0041B-K

- 30-01395-K** Plug adapters for Double Barrel Heater, Temp & HL Sensor for use in IQ2000(1995-2002)
- 34-01395-K** Replacement Sensor Kit for Watkins, Includes Temp Sensor, Hi-Limit & 2 O-Rings  
**Replaces: RME-01395, 39525, 39530**
- 48-0041-K** Turn-Around, Double Barrel Heater Manifold Kit
- 48-0041A-K** Gasket Kit for Double Barrel Heater
- 48-0041B-K** Barb 3/4" Kit for Double Barrel Heater
- 48-0201** Drain Tube Extension for Double Barrel Heater

## United Spas

Flo-Thru heater assembly, 2.25" x 13.25", 304SS, with studs. Includes 2"x2" tailpieces, 2" ridged gaskets.



**Incoloy Element**

**26-1206-7S-K** - 5.5kW/240V

**26-1206-5S-K** - 4.0kW/240V

**26-1206-4S-K** - 3.0kW/240V

**Titanium Element**

**26-1206-7T-K** - 5.5kW/240V

**26-1206-5T-K** - 4.0kW/240V

**26-1206-4T-K** - 3.0kW/240V

## United Spas

Flo-Thru heater assembly, 2.25" x 15", 304SS, cover plate. Includes 2"x2" tailpieces, 2" ridged gaskets.



**Incoloy Element**

**26-1227-7S-K** - 5.5kW/240V

**26-1227-5S-K** - 4.0kW/240V

**Titanium Element**

**26-1227-7T-K** - 5.5kW/240V

**26-1227-5T-K** - 4.0kW/240V

## Waterway

Flo-Thru heater assembly, 2.25" x 15", 304SS, M7 taps, with studs. Includes 2"x2" tailpieces, 2" ridged gaskets.



**Incoloy Element**

**26-0808-7SD-K** - 5.5kW/240V

**26-0808-5SD-K** - 4.0kW/240V

**Titanium Element**

**26-0808-7TD-K** - 5.5kW/240V

**26-0808-5TD-K** - 4.0kW/240V

Parts

**Balboa®**

Flo-Thru heater assembly, 2.25"x15", 304SS, PSI tap, with cover plate. Includes 2"x2" tailpieces, 2" ridged gaskets.



**Incoloy Element**

26-50080-K - 5.5kW/240V      26-50081-K - 4.0kW/240V

**Balboa®**

Flo-Thru heater assembly, 2.25"x15", 304SS, with PSI & guard, with cover plate. Includes 2"x2" tailpieces, 2" ridged gaskets.



**Incoloy Element**

26-50096-K - 5.5kW/240V      26-58081-K - 4.0kW/240V

**Balboa®**

Flo-Thru heater assembly, 2.25"x15", 304SS, M7 taps, with studs. Includes 2"x2" tailpieces, 2" ridged gaskets.



**Incoloy Element**

26-58002-K - 5.5kW/240V      26-58032-K - 4.0kW/240V

**Balboa®**

Flo-Thru heater assembly, 2.25"x15", 304SS, with M7 sensors, and studs. Includes 2"x2" tailpieces, 2" ridged gaskets.



**Incoloy Element**

26-58083-K - 5.5kW/240V      26-58118-K - 3.0kW/240V  
26-58104-K - 4.0kW/240V      26-58145-K - 2.0kW/240V  
26-58138-K - 1.5kW/240V

**Balboa®**

Flo-Thru heater assembly, 2.25"x15", 304SS, PSI tap, and sensor tap. Includes 2"x2" tailpieces, 2" ridged gaskets.



**Incoloy Element**

26-58027-K - 5.5kW/240V      26-58029-K - 4.0kW/240V

**Balboa®**

Flo-Thru heater assembly, 2.25"x15", 304SS, with PSI switch w/guard, and sensor tap. Includes 2"x2" tailpieces, 2" ridged gaskets.



**Incoloy Element**

26-58019-K - 5.5kW/240V      26-58048-K - 4.0kW/240V

**Balboa® VS100**

Flo-Thru heater assembly, 1.5"x10", VS100, w/M7 Sensors. Includes 2"x2" tailpieces, 2" ridged gaskets.



**Incoloy Element**

26-58198-K - 1.0kW/240V  
26-58203-K - 4.0kW/240V, 1.0kW/120V

All heater assemblies come with tail pieces and gaskets

**Aber-Pacific**

Low Flow 26" x 6", 1" tube, dual element trombone heater, 3' cord.



**Titanium Element**

26-C3556-2-5T-K - 4.0kW, 120/240V

**Aber-Pacific**

Low Flow 20" x 16" x 14", 1" tube, Squareback style heater with 32" pigtail cord.



**Titanium Element**

26-3238-1A-7T-K - 5.5kW, 120/240V

**Aber-Pacific / Artesian / Dynasty / Gecko**

Low Flow 21" x 14.5", 1" tube, dual element squareback style, 4-wire tube heater that wraps around Gecko M class control box.



**Titanium Element**

26-C3549-1-7T-K - 5.5kW, 120/240V

**Artesian / Atera/ HydroQuip / LA Spas**

Low Flow 26" x 14", 1" tube, squareback style, 26" cord pigtail ends, pressure switch tap

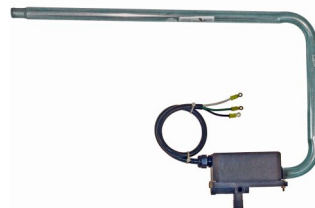

**Titanium Element**

26-3236-1A-5T-K - 4.0kW, 120/240V  
26-3236-2A-BT-K - 2.7kW, 120/240V

**Cal Spas**

Low Flow 1" tube with 26" Cord, minimum flow rate 10 GPM



**Titanium Element**

26-C3554-2-BT-K - 41" - 2.7kW, 120/240V  
26-C3554-3-5T-K - 41" - 4.0kW, 120/240V

**Parts**

# Replacement Heater Assemblies

## Low Flow Heaters

### Caldera/Watkins

Laing Trombone style, 1" tube, 40" cord, pressure switch cord, built-in Thermal Cut Out (TCO), and Titanium element

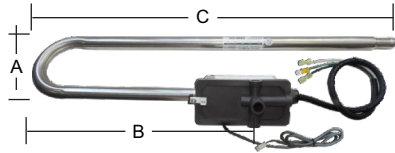

**Dimensions:**  
A: 5 $\frac{5}{8}$ "  
B: 15 $\frac{3}{4}$ "  
C: 26 $\frac{1}{2}$ "

#### Titanium Element

26-3473-1-5T-K - 1" - 4.0kW/240V  
26-3264-2-DT-K - 1" - 2.9kW/240V, Export

### Dimension One

Laing 1" tube, 26" x 6" dual element Trombone style, 3' cord, with pump adapter kit.



#### Titanium Element

26-C3556-1-7T-K - 5.5kW, 120/240V

### Dimension One/Jacuzzi

Laing, Squareback Style, 1" tube, built-in Manual Reset Thermal Cut Out (TCO), Mounting plate, 4 Wire and dual Titanium element.

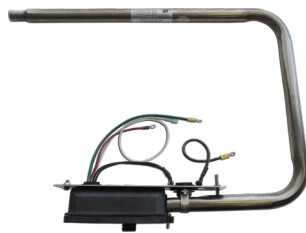

#### Titanium Element

26-C3550-1-7T-K - 1" - 3.4/2.1kW 120/240V

### Dimension One/Jacuzzi

Laing, Squareback Style, 1" tube, built-in Auto Reset Thermal Cut Out (TCO), Mounting plate, 4 Wire and dual Titanium element.

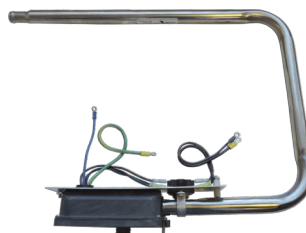

#### Titanium Element

26-C3552-1-7T-K - 1" - 3.4/2.1kW 120/240V

### Dimension One/Jacuzzi

Laing, Triple Bend, 1" tube, built-in Thermal Cut Out (TCO), 4 Wire and dual Titanium element.



#### Titanium Element

26-C3548-1-7T-K - 1" - 3.4/2.1kW 120/240V, Manual Reset TCO

### Dimension One/Jacuzzi

Laing, Triple Bend, 1" tube, built-in Thermal Cut Out (TCO), Flow Switch, 4 Wire and dual Titanium element.



#### Titanium Element

26-C3548-1-7T-F - 1" - 3.4/2.1kW 120/240V

### Sundance/Jacuzzi

Laing Trombone style, 1" tube, 25" cord, built-in Thermal Cut Out (TCO), and Titanium element

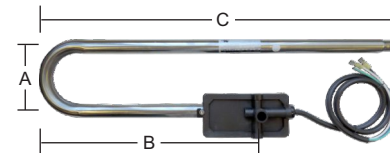

**Dimensions:**  
A: 5 $\frac{5}{8}$ "  
B: 15 $\frac{3}{4}$ "  
C: 26 $\frac{1}{2}$ "

#### Titanium Element

26-3226-1A-5T-K - 1" - 4.0kW/240V  
26-3226-2A-DT-K - 1" - 2.9kW/240V  
26-3226-2A-BT-K - 1" - 2.7kW/240V, Export  
26-3226-4A-ET-K - 1" - 2.1kW/240V

### Sundance

Plastic Smart Heater as used in Sundance Spas from 2000 to current. 3/4" barbed, hi-limit thermo-disc, and wires for connecting to control box.



#### Titanium Element

26-3314-1-7T-K - 5.5kW/240V  
26-3403-1-BT-K - 2.7kW/240V, Export

### Sundance/Jacuzzi

Laing Squareback style, 1" tube, 3 wire with spade connectors, built-in Thermal Cut Out (TCO), Titanium element

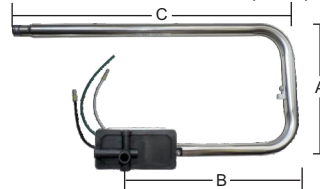

**Dimensions:**  
A: 10 $\frac{5}{8}$ "  
B: 13 $\frac{3}{4}$ "  
C: 23 $\frac{1}{2}$ "

#### Titanium Element

26-3229-2A-7T-K - 1" - 5.5kW/240V  
26-58388-5T-ATE - 1" - 4.0kW/240V  
26-3478-1A-BT-K - 1" - 2.7kW/240V, Export

### Therm Products

Low Flow 19" x 10" x 11" Tube squareback style heater with 3' amp cord, PSI with cord, minimum flow rate 10 GPM @ 2psi



#### Titanium Element

26-C3474-1-5T-K - 1" - 4.0kW 120/240V

All heater assemblies are available in 316L Stainless Steel Housings.

All heater assemblies come with tail pieces and gaskets

Parts

## THE UNIVERSAL LOW FLOW VERTICAL RITE-FIT HEATER

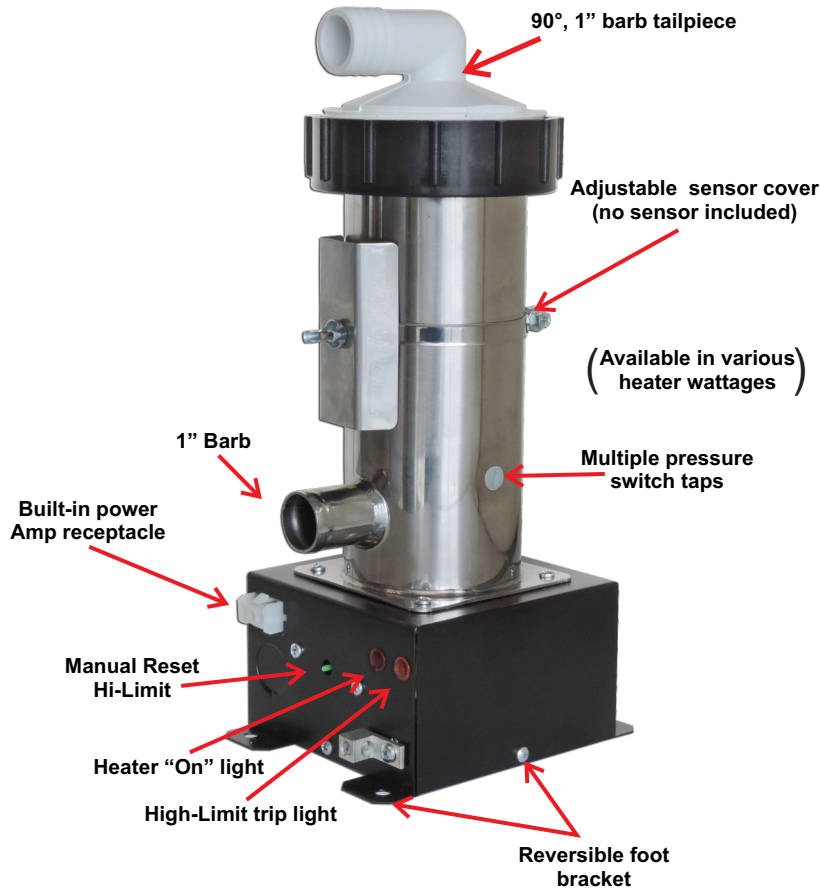

### STANDARD FEATURES

- Titanium LWD Element
- Heater "ON" Indicator Light
- Hi-Limit Tripped Indicator Light
- Built-In Manual Reset Hi-Limit
- 3 Pressure Switch Taps
- Reversible Foot Bracket
- Adjustable Sensor Cover Kit
- 1" x 12" Tubing
- Barb adapter .75" x 1.0"
- Replaceable Heater Element
- 60", 3-pin Amp Cord w/Terminals
- Tailpiece 3" x 1", 90 degree barb
- Individually Packaged
- Installation Instructions

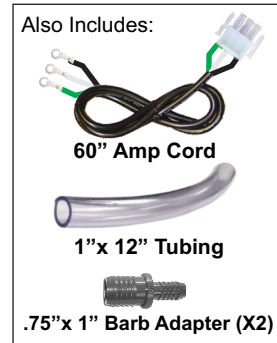

### Dimensions



## Universal Rite-Fit Low Flow Vertical Heaters

27-V310-7T-K	5.5kW, Titanium, Vertical Lo-Flo R/F Heater Assy
27-V310-6T-K	4.5kW, Titanium, Vertical Lo-Flo R/F Heater Assy
27-V310-5T-K	4.0kW, Titanium, Vertical Lo-Flo R/F Heater Assy
27-V310-4T-K	3.0kW, Titanium, Vertical Lo-Flo R/F Heater Assy
27-V310-2T-K	2.0kW, Titanium, Vertical Lo-Flo R/F Heater Assy

## Universal Low Flow Vertical Rite-Fit Heater Accessories

### Power Cord Options

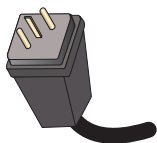

30-0130-60-K

60" Cord, Large Molded

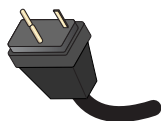

30-0131-60-K

60" Cord, Mini Molded

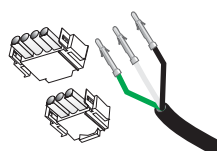

30-0133-60-K

60" Cord, 3 & 4Pin Amp

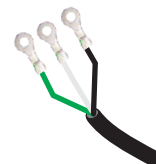

30-0132-60-K

60" Cord, 3 Ring Terminals  
(Included w/Heater)



Pressure Switch Kits

## Pressure Switch Accessories

48-0300-K	Pressure Switch Kit, 3" Canister, 1A. Torx
48-0301-K	Pressure Switch Kit, 3" Canister, 2A. Slot
34-0178A-K	Pressure Switch, 1A. Plastic, Torx
34-0178-K	Pressure Switch, 2A. Plastic, Slot
34-0153-K	Pressure Switch, 25A. Metal, Wheel
34-0019-C-K	Pressure Switch, 25A. Plastic, Wheel
30-0015G-K	Cord, Wire x 2P Amp, Pressure Switch, 60"
30-0015J-K	Cord, Wire x Wire, Pressure Switch, 60"



Flow Switch

## Flow Switch Options

34-0221-K	Flow Switch, .75" Barb x Barb Clear Tee
-----------	---



## Unions, Tailpieces & Gaskets

42-2360B-K	Uni-Nut, 3" Retaining Ring, White
42-2370-K	Uni-Nut, 3" Nut, Black
42-2380-K	Tailpiece, 3"x1", Vert. Barb
42-2386-K	Tailpiece, 3"x1", 90, Barb
42-2390-K	Tailpiece, 3"x.75", 90, Barb
42-2392-K	Tailpiece, 3"x1", 90, Soc
42-0013-K	Adaptor, Barb, .75"x1.0"
60-0020-K	Gasket, 3" Nut, Black



## Clamps

39-0010-UR7-K	Clamp Kit, 3" 10-32 x 1", Sensor Cover
39-0010-B-K	Clamp Kit, 3" 10-32 x .75" Mounting
39-0010-UR9-K	Clamp Kit, 3" 10-32 x .625"
39-0010-UR8-K	Clamp Kit, 3" 10-32 x 1.875" Encl. Mtg.



## Accessory Kits

48-0303-K	Sensor Kit, 3" Canister (No sensors included)
48-0304-K	Mounting Kit, 3" Canister
48-0305-K	Enclosure Kit, 3" Canister (No PS Included)



Spiral / Coil

## Heater Element Kits

12-0606F-K	Heater Element, 2.0kw, Ti
12-0604F-K	Heater Element, 3.0kw, Ti
12-0602F-K	Heater Element, 4.0kw, Ti
12-0601F-K	Heater Element, 4.5kw, Ti
12-0600F-K	Heater Element, 5.5kw, Ti

### Artesian / Majestic

Vertical Low Flow 13" x 3" with bulkhead coated element with box, cord and 3/4" barb



**Known Part Numbers:**  
**(5.5kW)** E2550-0114(ET), E2550-0014, C2550-0014ET  
**(4.0kW)** E2400-0114(ET), E2400-0014(ET), 48-3600-40-014

**Replace with Universal Vertical Low Flow Heater:**  
 See Page 8.42 for All Part Numbers

### Therm Products

Vertical Low Flow 10" x 3" with 1" x 1" barb and pressure switch and bare cord



**Known Part Numbers:**  
**(5.5kW)** E2550-0028C, 26-08112, 26-08116, 26-08103, 26-08106  
**(4.0kW)** E2400-0028C, 26-08108, 26-08118, 26-08119, 26-08109

**Replace with Universal Vertical Low Flow Heater:**  
 See Page 8.42 for All Part Numbers

### Dimension One / Crystal

Vertical Low Flow 10" x 3" with 1/2" snap nut



**Known Part Numbers:**  
**(4.0kW)** E2400-0004, 48-3600-40-004  
**(2.0kW)** E2200-0004

**DISCONTINUED**

### Therm Products

Vertical Low Flow 9.5" x 3" with pressure switch



**Known Part Numbers:**  
**(5.5kW)** E2550-0029C, 26-08107, 26-00107

**Replace with Universal Vertical Low Flow Heater:**  
 See Page 8.42 for All Part Numbers

### Dynasty

Vertical Low Flow 12" x 3" with box and pressure switch, 1" barb, 1" socket



**Known Part Numbers:**  
**(5.5kW)** E2550-0120C, 26-08125, 26-08147, 26-08120, 26-08153, 26-08155, 26-08156  
**(4.0kW)** 26-081214, 26-00155, 26-08145, 26-08146, 26-08159, 26-08157

**Replace with Universal Vertical Low Flow Heater:**  
 See Page 8.42 for All Part Numbers

### Therm Products

Vertical Low Flow 13" x 3" with wires and fork connectors



**Known Part Number:**  
**(5.5kW)** E2550-3314  
**(2.7kW)** E2270-3314

**Replace with Universal Vertical Low Flow Heater:**  
 See Page 8.42 for All Part Numbers

### Gatsby

Vertical Low Flow 10" x 7" with pressure switch and cord



**Titanium Element**  
**28-E0300-7T-K** - 5.5kW, 240V  
**28-E0300-5T-K** - 4.0kW, 240V  
**28-E0300-4T-K** - 3.0kW, 240V

**Replaces:**  
**(5.5kW)** E2550-0300ET, 26-08175, E2550-0301ET  
**(4.0kW)** E2400-0300ET, 26-08174, E2400-0301ET  
**(3.0kW)** E2300-0300ET

### Maax Spas

Vertical Low Flow 9.5" x 3" with pressure switch, 1" barbs, amp plug and cords



**Known Part Numbers:**  
**(4.0kW)** 26-08114, 26-08115, 26-08102  
**(3.0kW)** 26-08116

**Replace with Universal Vertical Low Flow Heater:**  
 See Page 8.42 for All Part Numbers

### Maax Spas

Vertical Low Flow 15" x 3" dual element with pressure switch



**Known Part Numbers:**  
**(3.6kW)** 26-08235, 26-08245

**Replace with Universal Vertical Low Flow Heater:**  
 See Page 8.42 for All Part Numbers

Introducing the new Universal Vertical Low Flow Heater which replaces every heater listed on this page.



See page 8.42 for more details

All heater assemblies are available in 316L Stainless Steel Housings.



# Replacement Heater Assemblies

## Vertical Low Flow Heaters w/o Box



### Artesian / Majestic

Vertical Low Flow 13" x 3" with bulkhead coated element and 3/4" barb



**Known Part Numbers:**  
**(5.5kW)** E2550-0115(ET), E2550-0015, E2550-0015ET  
**(4.0kW)** E2400-0115(ET), E2400-0015, E2400-0015ET  
**(2.0kW)** E2200-0115(ET), E2200-0015(ET)

**Replace with Universal Vertical Low Flow Heater:**  
 See Page 8.42 for All Part Numbers

### Caldera

Vertical Low Flow 11" x 3" with 2 thermo-wells and 3/4" barb



**Known Part Numbers:**  
**(5.5kW)** E2550-0001, 48-3300-40-001  
**(2.0kW)** E2200-0001

**Replace with Universal Vertical Low Flow Heater:**  
 See Page 8.42 for All Part Numbers

### Caldera

Vertical Low Flow 11" x 3" with 3/4" barb



**Known Part Numbers:**  
**(5.5kW)** E2550-0101  
**(4.0kW)** E2400-0101(ET), 48-3300-40-101

**Replace with Universal Vertical Low Flow Heater:**  
 See Page 8.42 for All Part Numbers

### Caldera

Vertical Low Flow 11" x 3" with 3/4" barb



**Known Part Numbers:**  
**(4.0kW)** E2400-0201(ET)  
**(2.0kW)** E2200-0201(ET)

**Replace with Universal Vertical Low Flow Heater:**  
 See Page 8.42 for All Part Numbers

### Clearwater Spas

Vertical Low Flow 10" x 3" with 1" barbs



**Known Part Numbers:**  
**(1" Barb)** E2400-0021-NP, E2400-0021ET, E2400-0021, E2400-0021ET-1, 26-00110  
**(3/4" Barb)** E2400-0221

**Replace with Universal Vertical Low Flow Heater:**  
 See Page 8.42 for All Part Numbers

### Dimension One

Vertical Low Flow 10" x 3" with 3/4" barbs



**Known Part Numbers:**  
**(4.0kW)** E2400-0003, 48-3600-40-003  
**(2.0kW)** E2200-0003

**Replace with Universal Vertical Low Flow Heater:**  
 See Page 8.42 for All Part Numbers

### DM / Vita Spas

Vertical Low Flow 11" x 3" with 2 PSI Taps and 3/4" barb



**Known Part Numbers:**  
**(4.5kW)** E2450-0127ET(X), E2450-1127ET  
**(4.0kW)** E2400-0127ET(X), E2400-1127ET, E2400-0126ET, E2400-0026, E2400-1127  
**(3.0kW)** E2300-0127ET(X), E2300-0126ET  
**(2.5kW)** E2250-0127ETX

**Replace with Universal Vertical Low Flow Heater:**  
 See Page 8.42 for All Part Numbers

### Gatsby / Hurricane / Leisure Bay

Vertical Low Flow 9" x 3" with 1" barb and 12" Wires, coated element.



**Known Part Numbers:**  
**(5.5kW)** E2550-0202(ET), E2550-0202-1, E2550-0202ET-1, E2550-0204, E2550-0204ET, E2550-0102ET, 26-00141  
**(4.0kW)** E2400-0202ET, E2400-0202-1, E2400-0204, E2400-0204ET  
**(2.5kW)** E2250-0204(ET)

**Replace with Universal Vertical Low Flow Heater:**  
 See Page 8.42 for All Part Numbers

**Introducing the new Universal Vertical Low Flow Heater which replaces every heater listed on this page.**

If your spa heater assembly is mounted on the side of the control box we have a Universal Vertical Low Flow Heater Assembly which can be used as a retro-fit replacement utilizing the optional side mounting kit. In addition, we offer a number of other optional accessories for a successful retro-fit.

Example of the Universal Vertical Low Flow Heater mounted on a typical control box below.

Optional Side Mounting Kit Part# 48-0304-K

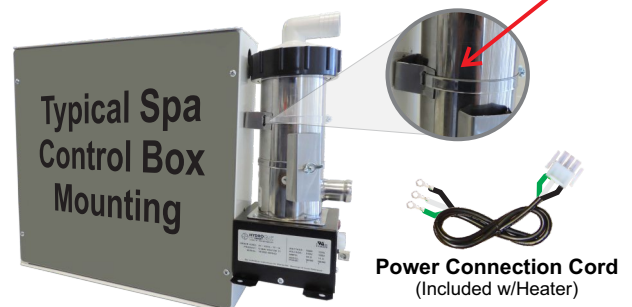

See page 8.42 for more details

All heater assemblies are available in 316L Stainless Steel Housings.

Visit us at [hydroquip.com](http://hydroquip.com)

Parts

### Gatsby / Hurricane / Leisure Bay

Vertical Low Flow 9" x 3" with 1" barb and 12" Wires, coated element.



**Known Part Numbers:**  
**(5.5kW)** E2550-0203(ET)  
**(4.0kW)** E2400-0203(ET)

**Replace with Universal Vertical Low Flow Heater:**

See Page 8.42 for All Part Numbers

### Maax Spas / Savannah

Vertical Low Flow 10" x 3"



**Known Part Numbers:**  
**(4.0kW)** 26-00257, 26-00254  
**(5.5kW)** 26-00255

**Replace with Universal Vertical Low Flow Heater:**

See Page 8.42 for All Part Numbers

### Nu Wave

Vertical Low Flow 9.5" x 1.5"



**Known Part Numbers:**  
**(4.0kW)** E2400-0007, 20-00514

**Replace with Universal Vertical Low Flow Heater:**

See Page 8.42 for All Part Numbers

### Pinnacle

Vertical Low Flow 10" x 3"



**Known Part Numbers:**  
**(4.0kW)** E2400-0027

**Replace with Universal Vertical Low Flow Heater:**

See Page 8.42 for All Part Numbers

### Pinnacle / Leisure Bay / Hurricane

Vertical Low Flow 9" x 3" with 1" barbs and wire studs



**Known Part Numbers:**  
**(5.5kW)** E2550-020X(ET), E2550-020X-1,  
 26-00100, 48-3300-40-020  
**(2.5kW)** E2250-020X(-1)

**Replace with Universal Vertical Low Flow Heater:**

See Page 8.42 for All Part Numbers

### Saratoga

Vertical Low Flow 13.5" x 3"



**Known Part Numbers:**  
**(5.5kW)** E2550-0320(ET),  
 E2550-0320ET+  
**(4.0kW)** E2400-0420ET, E2400-0421ET,  
 20-00540, E2400-0320(ET), 20-0320ET+

**DISCONTINUED**

### Saratoga

Vertical Low Flow 13" x 3" with 3/4" barb and dual element



**Known Part Numbers:**  
**(3.0kW)** E2300-0542ET, E2300-0321,  
 E2300-0321ET, 20-00542

**DISCONTINUED**

### SBSG

Vertical Low Flow 9" x 3" with 1" barb and dual element



**Known Part Numbers:**  
**(5.5kW)** E2550-0351(ET)  
**(4.0kW)** E2400-0351(ET)

**Replace with Universal Vertical Low Flow Heater:**

See Page 8.42 for All Part Numbers

### SBSG

Vertical Low Flow 11" x 3"



**Known Part Numbers:**  
**(5.5kW)** E2550-0012  
**(4.0kW)** E2400-0012  
**(3.0kW)** E2300-0012  
**(2.7kW)** E2270-0012  
**(2.5kW)** E2250-0012

**Replace with Universal Vertical Low Flow Heater:**

See Page 8.42 for All Part Numbers

### Sundance

Vertical Low Flow 13" x 3.5" with 3/4" barbs



**Known Part Numbers:**  
**(5.5kW)** E2550-1000, C2783-1  
**(2.7kW)** E2270-1000

**Replace with :**

**(5.5kW)** 26-3314-1-7T-K - 5.5kW/240V  
**(2.7kW)** 26-3403-1-BT-K - 2.7kW/240V, Export

See Page 8.41

**Introducing the new Universal Vertical Low Flow Heater which replaces every heater listed on this page.**

If your spa heater assembly is mounted on the side of the control box we have a Universal Vertical Low Flow Heater Assembly which can be used as a retro-fit replacement utilizing the optional side mounting kit. In addition, we offer a number of other optional accessories for a successful retro-fit.

Example of the Universal Vertical Low Flow Heater mounted on a typical control box below.

Optional Side Mounting Kit Part# **48-0304-K**



# Replacement Heater Assemblies

## HQ Series

### Air Slide 6000 Series

Slide heater, 2.25"x15", 304SS, PSI switch, auto-reset H/L, 30" cords. Includes 2"x2" tailpieces, 2" ridged gaskets.



**Incoloy Element**

26-87B-S80-1FM3 - 5.5kW/240V  
26-86B-S80-1FM3 - 4.5kW/240V  
26-85B-S80-1FM3 - 4.0kW/240V

**Titanium Element**

26-8RB-S80-1FM3  
26-8QB-S80-1FM3  
26-8PB-S80-1FM3

### Air Versi-Heat 6000 Series

Versi-Heat assy, 2.25"x15", 304SS, PSI switch, auto-reset H/L, 60" cords. Includes 2"x2" tailpieces, 2" ridged gaskets.



**Incoloy Element**

26-87B-080-1PM3 - 5.5kW/240V  
26-86B-080-1PM3 - 4.5kW/240V  
26-85B-080-1PM3 - 4.0kW/240V

**Titanium Element**

26-8RB-080-1PM3  
26-8QB-080-1PM3  
26-8PB-080-1PM3

### Air Slide 4000 Series

Slide heater, 2.25"x17", "L" shaped, 304SS, PSI switch, auto-reset H/L, 30" cords. Includes 2"x2" tailpieces, 2" ridged gaskets.



**Incoloy Element**

26-67B-S80-1FM3 - 5.5kW/240V  
26-66B-S80-1FM3 - 4.5kW/240V  
26-65B-S80-1FM3 - 4.0kW/240V

**Titanium Element**

26-6RB-S80-1FM3  
26-6QB-S80-1FM3  
26-6PB-S80-1FM3

### Air Versi-Heat 4000 Series

Versi-Heat heater, 2.25"x17", 304SS, "L" shaped, PSI switch, auto-reset H/L, 60" cords. Includes 2"x2" tailpieces, 2" ridged gaskets.



**Incoloy Element**

26-67B-080-1PM3 - 5.5kW/240V  
26-66B-080-1PM3 - 4.5kW/240V  
26-65B-080-1PM3 - 4.0kW/240V

**Titanium Element**

26-6RB-080-1PM3  
26-6QB-080-1PM3  
26-6PB-080-1PM3

### Air 1001 Series

Cs1001 heater, 2.25"x15", 304SS, PSI tap, cover plate and H/L studs. Includes 2"x2" tailpieces, 2" ridged gaskets.



**Incoloy Element**

48-260032-R1 - 5.5kW/240V  
48-260034-R1 - 4.5kW/240V  
48-260036-R1 - 4.0kW/240V

### Air 800 Series

Cs800 heater, 2.25"x15", 304SS, PSI tap, cover plate and studs. Includes 2"x2" tailpieces, 2" ridged gaskets.

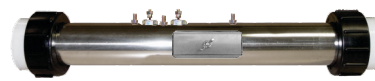

**Incoloy Element**

26-0047-K - 5.5kW/240V

### Balboa® Slide 6000B Series

Slide heater assembly, 2.25"x15", 304SS, with M7® sensors, 30" cords. Includes 2"x2" tailpieces, 2" ridged gaskets.



**Incoloy Element**

26-87M-S00-1F03 - 5.5kW/240V  
26-85M-S00-1F03 - 4.0kW/240V

**Titanium Element**

26-8RM-S00-1F03  
26-8QM-S00-1F03

### Balboa® Versi-Heat 6000B Series

Versi-Heat heater assembly, 2.25"x15", 304SS, with M7® sensors, 60" cords. Includes 2"x2" tailpieces, 2" ridged gaskets.



**Incoloy Element**

26-87M-000-1P03 - 5.5kW/240V  
26-86M-000-1P03 - 4.5kW/240V

**Titanium Element**

26-8RM-000-1P03  
26-8PM-000-1P03

### Balboa® WaterPro 6000B Series w/Sensors

Flo-Thru heater assembly, 2.25"x15", 304SS, with M7 sensors, and studs. Includes 2"x2" tailpieces, 2" ridged gaskets.



**Incoloy Element**

26-0071-M7-KS - 5.5kW/240V

**Titanium Element**

26-0071-F-M7-KS

### Balboa® WaterPro 6000B Series w/o Sensors

Flo-Thru heater assembly, 2.25"x15", 304SS, M7 taps, with studs. Includes 2"x2" tailpieces, 2" ridged gaskets.



**Incoloy Element**

26-0071-M7-K - 5.5kW/240V

**Titanium Element**

26-0071-F-M7-K

### Balboa® Slide 4000B Series

Slide heater assembly, 2.25"x17", 304SS, "L" shaped, with M7 sensors, 30" cords. Includes 2"x2" tailpieces, 2" ridged gaskets.



**Incoloy Element**

26-67M-S00-1F03 - 5.5kW/240V

**Titanium Element**

26-6RM-S00-1F03

Parts

### Balboa® Versi-Heat 4000B Series

Slide heater assembly, 2.25"x17", 304SS, "L" shaped, with M7 sensors, 60" cords. Includes 2"x2" tailpieces, 2" ridged gaskets.



**Incoloy Element**

26-67M-000-1PP3 - 5.5kW/240V

**Titanium Element**

26-6RM-000-1PP3

### Gecko Slide 6000/7000 Series

Slide heater assembly, 2.25"x15", 304SS, PSI switch, 30" cords. Includes 2"x2" tailpieces, 2" ridged gaskets.



**Incoloy Element**

26-87B-S00-1FP3 - 5.5kW/240V  
26-86B-S00-1FP3 - 4.5kW/240V  
26-85B-S00-1FP3 - 4.0kW/240V

**Titanium Element**

26-8RB-S00-1FP3  
26-8QB-S00-1FP3  
26-8PB-S00-1FP3

### Gecko Versi-Heat 6000/7000 Series

Versi-Heat heater assembly, 2.25"x15", 304SS, PSI switch, 60" cords. Includes 2"x2" tailpieces, 2" ridged gaskets.



**Incoloy Element**

26-87B-000-1PP3 - 5.5kW/240V  
26-86B-000-1PP3 - 4.5kW/240V  
26-85B-000-1PP3 - 4.0kW/240V

**Titanium Element**

26-8RB-000-1PP3  
26-8QB-000-1PP3  
26-8PB-000-1PP3

### Gecko Slide 4000 Series

Slide heater assy, 2.25"x17", "L" shaped, 304SS, PSI switch, 30" cords. Includes 2"x2" tailpieces, 2" ridged gaskets.



**Incoloy Element**

26-67B-S00-1FP3 - 5.5kW/240V  
26-66B-S00-1FP3 - 4.5kW/240V  
26-65B-S00-1FP3 - 4.0kW/240V

**Titanium Element**

26-6RB-S00-1FP3  
26-6QB-S00-1FP3  
26-6PB-S00-1FP3

### Gecko Versi-Heat 4000 Series

Versi-Heat heater assy, 2.25"x17", 304SS, "L" shaped, PSI switch, 60" cords. Includes 2"x2" tailpieces, 2" ridged gaskets.



**Incoloy Element**

26-67B-000-1PP3 - 5.5kW/240V  
26-66B-000-1PP3 - 4.5kW/240V  
26-65B-000-1PP3 - 4.0kW/240V

**Titanium Element**

26-6RB-000-1PP3  
26-6QB-000-1PP3  
26-6PB-000-1PP3

### Gecko WaterPro 6000 Series

Flo-Thru heater assembly, 2.25"x15", 304SS, PSI tap, cover plate with studs. Includes 2"x2" tailpieces, 2" ridged gaskets.



**Incoloy Element**

26-0071-K - 5.5kW/240V  
26-0071B-K - 4.0kW/240V  
26-0071A-K - 4.5kW/240V

**Titanium Element**

26-0071-F-K  
26-0071B-F-K  
26-0071A-F-K

### Gecko WaterPro 7000 Series

Flo-Thru heater assembly, 2.25"x15", 304SS, PSI tap, cover plate with studs. Includes 2"x2" tailpieces, 2" ridged gaskets.



**Incoloy Element**

26-0071-7KSS-K - 5.5kW/240V  
26-0071-5KSS-K - 4.0kW/240V

**Titanium Element**

26-0071-F-7KSS-K  
26-0071-F-5KSS-K

### Gecko WaterPro 6000 Series

Flo-Thru heater assembly, 2.25"x15", 304SS, PSI tap, cover plate with studs. Includes 2"x2" tailpieces, 2" ridged gaskets. For fixed heater units with front access brackets.



**Incoloy Element**

26-0079-K - 5.5kW/240V  
26-0079B-K - 4.0kW/240V

### Gecko Slide 9700 Series

Slide heater assembly, 2.25"x16.25", 304SS, PSI switch, 30" cords. Includes 2"x2" tailpieces, 2" ridged gaskets.



**Incoloy Element**

26-K7B-S50-1FP3 - 5.5kW/240V  
26-K6B-S50-1FP3 - 4.5kW/240V  
26-K5B-S50-1FP3 - 4.0kW/240V

**Titanium Element**

26-KRB-S50-1FP3  
26-KQB-S50-1FP3  
26-KPB-S50-1FP3

### Gecko Versi-Heat 9700 Series

Versi-Heat assembly, 2.25"x16.25", 304SS, PSI switch, 60" cords. Includes 2"x2" tailpieces, 2" ridged gaskets.



**Incoloy Element**

26-K7B-050-1PP3 - 5.5kW/240V  
26-K6B-050-1PP3 - 4.5kW/240V  
26-K5B-050-1PP3 - 4.0kW/240V

**Titanium Element**

26-KRB-050-1PP3  
26-KQB-050-1PP3  
26-KPB-050-1PP3

### Gecko Versi-Heat

Versi-Heat assembly, 2.25", 316L, PSI switch, 60" cords 3 pin & 6 pin plugs, with Hi-Limit Sensor. Includes 2"x2" tailpieces, 2" ridged gaskets.



**Incoloy Element**

26-C63-050-0G00 - 2.25" x 13" - 4.5kW/240V

# Replacement Heater Assemblies

## HQ Series Cont'd

### Outdoor Balboa Series - ES/CS87/8800

Outdoor heater assembly, 2.25"x19.25", 316L, M7 sensors, and studs. Includes 2"x2" tailpieces, 2" ridged gaskets.



**Titanium Element**

- 26-0054AF-M7-KS - 11kW/240V - Dual Elements
- 26-0053-F-M7-KS - 5.5kW/240V

### Outdoor Balboa Series - ES/CS87/8800

Outdoor heater assembly for Gas/Ready, 2.25"x19.25", 304SS, M7 sensors, studs, no heater element. Includes 2"x2" tailpieces, 2" ridged gaskets.



**No Element - Gas Ready Systems**

- 26-0063-XD-KS - with M7 Sensors
- 26-0063-XD-K - without Sensors

### Outdoor Gecko Y Series - ES/CS8900

Outdoor heater assembly, 2.25"x19.25", 316L, in.flo sensors, studs. Includes 2"x2" tailpieces, 2" ridged gaskets.



**Titanium Element**

- 26-0053-F-Y-KS - 5.5kW/240V - with In.Flo Sensors
- 26-0054-F-Y-KS - 11kW/240V - with In.Flo Sensors

### Outdoor Gecko Y Series - ES/CS8900 Gas Ready

Outdoor heater assembly, 2.25"x19.25", 316L, in.flo sensors, studs. Includes 2"x2" tailpieces, 2" ridged gaskets.



**No Element - Gas Ready Systems**

- 26-0063-Y - with In.Flo Sensors

### Outdoor Gecko Series - ES/CS8600

Outdoor heater assembly, 2.25"x19.25", 304SS, PSI tap, cover plate, and studs. Includes 2"x2" tailpieces, 2" ridged gaskets.



**Titanium Element**

- 26-0054A-K - 11kW/240V - Dual Elements
- 26-0053-K - 5.5kW/240V

### Outdoor Gecko Series - ES/CS8600

Outdoor heater assembly, 3"x19.25", 304SS, PSI tap, cover plate, and studs. Includes 2"x2" tailpieces, 2" ridged gaskets.



**Incoloy Element**

- 26-0054-K - 11kW/240V - Dual Elements

### Outdoor Series - ES/CS8600 Gas Ready

Outdoor heater assembly, 2.25"x19.25", 304SS, PSI tap, cover plate, studs, no heater element. Includes 2"x2" tailpieces, 2" ridged gaskets.



**No Element - Gas Ready Systems**

- 26-0063-XD-KP - No Element

### Outdoor Series - Heatmax 5.5kW

Heatmax 2.25" 304SS, "U" shaped heater assembly, 2.25", PSI tap, cover plate. Includes 2"x2" tailpieces, 2" ridged gaskets.



**Incoloy Element**

- 26-0082-K - "U" Shaped - 5.5kW/240V

**Titanium Element**

- 26-0082-F-K

### Outdoor Series - Heatmax 11kW

Heatmax 2.25" 304SS, "U" shaped heater assembly, 2.25", PSI tap, cover plate. Includes 2"x2" tailpieces, 2" ridged gaskets.



**Incoloy Element**

- 26-0082A-K - 11kW/240V - Dual Elements

**Titanium Element**

- 26-0082A-F-K

### Lo-Flo Series - Laing Style Versi-Heat

Laing Trombone style, 1" tube, 25" cord, built-in Thermal Cut Out (TCO) and Slide Hardware Kit.

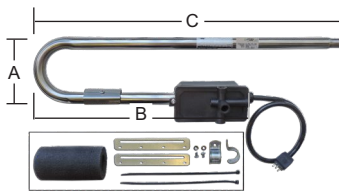

**Dimensions:**

- A: 5 5/8"
- B: 15 3/4"
- C: 26 1/2"

**Incoloy Element**

- 26-MP0-00A-0F00 - 1" - 4.0kW/1.0kW, 240V/120V

### Lo-Flo Series - Laing Style Versi-Heat

Low flow heater kits for replacement of Versi-Heat heaters with 9-pin plug adapters. Includes Flow switch kit or PSI Switch, 6.5" pre-installed cord with ring terminals

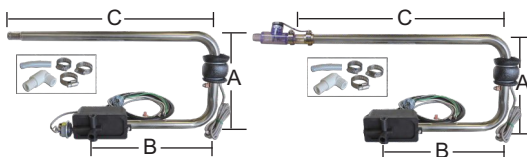

**Dimensions:**

- 26-0066-KIT-FS - 5.5kW/240V (Flow switch)
- 26-0066-KIT-PS - 5.5kW/240V (PSI switch)

- A: 10 5/8"
- B: 13 3/4"
- C: 23 1/2"

## Universal Rite-Fit Series

### Balboa® Series

Universal Rite-Fit Balboa Series heater assembly, 2.25"x15", 304SS, multiple PSI taps, M7 taps, adjustable cover plate, and adjustable studs. Includes 2"x2" tailpieces 2" ridged gaskets, 4" and 12" wire sets.



Incoloy Element	Titanium Element	
27-J0425-7S-K	27-J0425-7T-K	5.5kW/240V
27-J0425-6S-K	27-J0425-6T-K	4.5kW/240V
27-J0425-5S-K	27-J0425-5T-K	4.0kW/240V
27-J0425-AS-K	27-J0425-AT-K	3.6kW/240V
27-J0425-4S-K	27-J0425-4T-K	3.0kW/240V
27-J0425-3S-K	27-J0425-3T-K	2.5kW/240V
27-J0425-2S-K	27-J0425-2T-K	2.0kW/240V
27-J0425-XS-K	27-J0425-XT-K	1.3kW/240V

### HQ Series

Universal Rite-Fit Hydro-Quip Series heater assembly, 2.25", 304SS, multiple PSI taps, adjustable cover plate, and adjustable studs. Includes 2"x2" tailpieces 2" ridged gaskets.



Incoloy Element	Titanium Element	
27-J0519-7S-K	27-J0519-7T-K	5.5kW/240V
27-J0519-6S-K	27-J0519-6T-K	4.5kW/240V
27-J0519-5S-K	27-J0519-5T-K	4.0kW/240V
27-J0519-AS-K	27-J0519-AT-K	3.6kW/240V
27-J0519-4S-K	27-J0519-4T-K	3.0kW/240V
27-J0519-3S-K	27-J0519-3T-K	2.5kW/240V
27-J0519-2S-K	27-J0519-2T-K	2.0kW/240V
27-J0519-XS-K	27-J0519-XT-K	1.3kW/240V

### Gecko Series

Universal Rite-Fit Gecko Series heater assembly, 2.25"x15", 304SS, multiple PSI taps, adjustable cover plate, and adjustable studs. Includes 2"x2" tailpieces 2" ridged gaskets.



Incoloy Element	Titanium Element	
27-J0568-7S-K	27-J0568-7T-K	5.5kW/240V
27-J0568-6S-K	27-J0568-6T-K	4.5kW/240V
27-J0568-5S-K	27-J0568-5T-K	4.0kW/240V
27-J0568-AS-K	27-J0568-AT-K	3.6kW/240V
27-J0568-4S-K	27-J0568-4T-K	3.0kW/240V
27-J0568-3S-K	27-J0568-3T-K	2.5kW/240V
27-J0568-2S-K	27-J0568-2T-K	2.0kW/240V
27-J0568-XS-K	27-J0568-XT-K	1.3kW/240V

### Universal Rite-Fit Series

Universal Rite-Fit Series heater assembly, 2.25"x15", 304SS, multiple PSI taps, adjustable cover plate, and adjustable studs. Includes 2"x2" tail pieces 2" ridged gaskets.



Incoloy Element	Titanium Element	
27-J0413-7S-K	27-J0413-7T-K	5.5kW/240V
27-J0413-6S-K	27-J0413-6T-K	4.5kW/240V
27-J0413-5S-K	27-J0413-5T-K	4.0kW/240V
27-J0413-AS-K	27-J0413-AT-K	3.6kW/240V
27-J0413-4S-K	27-J0413-4T-K	3.0kW/240V
27-J0413-3S-K	27-J0413-3T-K	2.5kW/240V
27-J0413-2S-K	27-J0413-2T-K	2.0kW/240V
27-J0413-XS-K	27-J0413-XT-K	1.3kW/240V

### VH 9-Pin Retro-Fit w/Cord

Heater assembly, 2.25",304SS, PSI switch, 60" cords. Includes 2"x2" tailpieces, 2" ridged gaskets. Does not include Hi-Limit sensor.



#### Incoloy Element

48-0007A	2.25"x13" - 5.5kW/240V
48-0007B	2.25"x15" - 5.5kW/240V

### VH 9-Pin Retro-Fit without Cord

Heater assembly, 2.25",304SS, PSI switch. Includes 2"x2" tailpieces, 2" ridged gaskets. Does not include Hi-Limit sensor.



#### Incoloy Element

48-0019	2.25"x13" - 5.5kW/240V
48-0019A	2.25"x15" - 5.5kW/240V

### CS300/AP-2 Heater Housing Kit

Heater housing kit, includes ABS housing, bushing, union, and O-ring gasket.



### CS500/4000 Heater Housing Kit

Heater housing kit, includes ABS housing, bushing, union, O-ring gasket, hi-limit reset button, and cover plate.



### CS300/500/4000/AP-2 Heater Housing Parts

02-0055	Rivet, Hi-Limit Reset
15-0031	Bushing, Heater Housing, Threaded
42-0005	Union, Pump, 1.5"
60-0001	O-Ring Heater, 5x5 Flange
65-0119A	Plate, Cover, Heater Kits, No Slots

### Heater Kit w/Thermostat & without Thermostat

Heater kit, built in thermostat\*, PSI switch and hi-limit. Includes assorted fittings.

*48-0017A	5.5kW/240V, w/Thermostat
*48-0017	4.5kW/240V, w/Thermostat
48-0018A	5.5kW/240V, without Thermostat
48-0018	4.5kW/240V, without Thermostat



Universal Rite-Fit Heaters Do Not Include: Sensors or Pressure Switches

# Replacement Heater Assemblies

## Utility Series



### 12" - Single Element

Utility flo-thru heater assembly, 2.25" X 12", 304SS, PSI taps, adjustable cover plate and studs, 45" cords. Includes 2"x2" tail pieces, 2" ridged gaskets.

*Titanium version comes with a 316L heater housing.*



<u>Incoloy Element</u>	<u>Titanium Element</u>	
26-320-000-1B03	26-3J0-00A-1B03	2.0kW/240V
26-330-000-1B03	26-3K0-00A-1B03	2.5kW/240V
26-340-000-1B03	26-3L0-00A-1B03	3.0kW/240V
26-3A0-000-1B03	26-3M0-00A-1B03	3.6kW/240V
26-350-000-1B03	26-3P0-00A-1B03	4.0kW/240V
26-360-000-1B03	26-3Q0-00A-1B03	4.5kW/240V
26-370-000-1B03	26-3R0-00A-1B03	5.5kW/240V

### 13.375" - Single Element

Utility flo-thru heater assembly, 2.25" X 13.375", 304SS, PSI taps, adjustable cover plate and studs, 45" cords. Includes 2"x2" tail pieces, 2" ridged gaskets.

*Titanium version comes with a 316L heater housing.*



<u>Incoloy Element</u>	<u>Titanium Element</u>	
26-C20-000-1B03	26-CJ0-00A-1B03	2.0kW/240V
26-C30-000-1B03	26-CK0-00A-1B03	2.5kW/240V
26-C40-000-1B03	26-CL0-00A-1B03	3.0kW/240V
26-CA0-000-1B03	26-CM0-00A-1B03	3.6kW/240V
26-C50-000-1B03	26-CP0-00A-1B03	4.0kW/240V
26-C60-000-1B03	26-CQ0-00A-1B03	4.5kW/240V
26-C70-000-1B03	26-CR0-00A-1B03	5.5kW/240V

### 15" - Single Element

Utility flo-thru heater assembly, 2.25" X 15", 304SS, PSI taps, adjustable cover plate and studs, 45" cords. Includes 2"x2" tail pieces, 2" ridged gaskets.

*Titanium version comes with a 316L heater housing.*



<u>Incoloy Element</u>	<u>Titanium Element</u>	
26-820-000-1B03	26-8J0-00A-1B03	2.0kW/240V
26-830-000-1B03	26-8K0-00A-1B03	2.5kW/240V
26-840-000-1B03	26-8L0-00A-1B03	3.0kW/240V
26-8A0-000-1B03	26-8M0-00A-1B03	3.6kW/240V
26-850-000-1B03	26-8P0-00A-1B03	4.0kW/240V
26-860-000-1B03	26-8Q0-00A-1B03	4.5kW/240V
26-870-000-1B03	26-8R0-00A-1B03	5.5kW/240V

### 16.25" - Single Element

Utility flo-thru heater assembly, 2.25" X 16.25", 304SS, PSI taps, adjustable cover plate and studs, 45" cords. Includes 2"x2" tailpieces, 2" ridged gaskets.

*Titanium version comes with a 316L heater housing.*



<u>Incoloy Element</u>	<u>Titanium Element</u>	
26-K20-000-1B03	26-KJ0-00A-1B03	2.0kW/240V
26-K30-000-1B03	26-KK0-00A-1B03	2.5kW/240V
26-K40-000-1B03	26-KL0-00A-1B03	3.0kW/240V
26-KA0-000-1B03	26-KM0-00A-1B03	3.6kW/240V
26-K50-000-1B03	26-KP0-00A-1B03	4.0kW/240V
26-K60-000-1B03	26-KQ0-00A-1B03	4.5kW/240V
26-K70-000-1B03	26-KR0-00A-1B03	5.5kW/240V

### 19.25" - Single Element

Utility flo-thru heater assembly, 2.25" X 19.25", 304SS, PSI taps, adjustable cover plate and studs, 45" cords. Includes 2"x2" tailpieces, 2" ridged gaskets.

*Titanium version comes with a 316L heater housing.*



<u>Incoloy Element</u>	<u>Titanium Element</u>	
26-J20-000-1B03	26-JJ0-00A-1K03	2.0kW/240V
26-J30-000-1B03	26-JK0-00A-1K03	2.5kW/240V
26-J40-000-1B03	26-JL0-00A-1K03	3.0kW/240V
26-JA0-000-1B03	26-JM0-00A-1K03	3.6kW/240V
26-J50-000-1B03	26-JP0-00A-1K03	4.0kW/240V
26-J60-000-1B03	26-JQ0-00A-1K03	4.5kW/240V
26-J70-000-1B03	26-JR0-00A-1K03	5.5kW/240V

### 19.25" - Dual Element

Utility flo-thru heater assembly, dual element, 2.25" X 19.25", 304SS, PSI taps, adjustable cover plate and studs, 45" cords. Includes 2"x2" tail pieces, 2" ridged gaskets.

*Titanium version comes with a 316L heater housing.*



<u>Incoloy Element</u>	<u>Titanium Element</u>	
26-HD0-000-1J03	26-HD0-00A-1J03	7.2kW/240V
26-H*0-000-1J03	26-H*0-00A-1J03	11kW/240V

Parts

CORD PART NO.	DESCRIPTION	WIRE GAUGE	COLOR
30-0180-48-K	Cord, Ozone, Molded, 48"	18/3	 YELLOW
30-0180-96	Cord, Ozone, Molded, 96"	18/3	
30-1180-L6	Adapter Cord, 6", Yel, Ozone Amp to Molded	18/3	
30-1180-L48	Cord, Yel, Ozone Amp to Molded, Univ	18/3	
30-1180-L96	Cord, Yel, Ozone Amp to Molded, Univ	18/3	
09-0018C-A	Receptacle, Ozone, Molded/Colored	18/3	
30-0190-48	Cord, Switched ACC., Molded, 48"	18/3	 LT. VIOLET
30-0190-96	Cord, Switched ACC., Molded, 96"	18/3	
30-0190-30	Cord, Slide, Heater Control (PSI), Molded, 30"	18/3	
30-0190-60VH	Cord, VH, Heater Control (PSI), Molded, 60"	18/3	
09-0019C-A	Receptacle, Switched ACC., Molded/Colored	18/3	
30-0200-48-K	Cord, Blower, Molded, 48"	18/3	 VIOLET
30-0200-96	Cord, Blower, Molded, 96"	18/3	
30-1200-L6	Adapter Cord, 6", Vio, Blwr Amp to Molded	18/3	
30-1200-L48	Cord, Vio, Blwr Amp to Molded, Univ	18/3	
30-1200-L96-K	Cord, Vio, Blwr Amp to Molded, Univ	18/3	
09-0020C-A	Receptacle, Blower, Molded/Colored	18/3	
30-0210-48-S	Cord, Circ. Pump, Molded, 48"	18/3	 BLUE
30-0210-96-K	Cord, Circ. Pump, Molded, 96"	18/3	
30-1210-L6	Adapter Cord, 6", BL, Circ Amp to Molded	18/3	
30-1210-L48	Cord, BL, Circ Amp to Molded, Univ	18/3	
30-1210-L96	Cord, BL, Circ Amp to Molded, Univ	18/3	
09-0021C-A	Receptacle, Circ, Pump, Molded/colored	18/3	
30-0220-48-K	Cord, Pump 1, 2-Speed, Molded, 48"	14/4	 RED
30-0220-96-K	Cord, Pump 1, 2-Speed, Molded, 96"	14/4	
30-1220-L6	Adapter Cord, 6", Red, P1, 2 Speed Amp to Molded	14/4	
30-1220-L48	Cord, Red, P1, 2 Molded, Univ	14/4	
30-1220A-L48	Cord, Red, P1, 2 Molded, Reversed	14/4	
30-1220-L96	Cord, Red, P1, 2 Molded, Univ	14/4	
09-0022C-A	Receptacle, Pump 1, 2 Speed, Molded/Colored	14/4	
30-0230-48-K	Cord, Pump 2, 2-Speed, Molded, 48"	14/4	 BROWN
30-0230-96-K	Cord, Pump 2, 2-Speed, Molded, 96"	14/4	
30-1230-L6	Adapter Cord, 6", Brown, P2, 2 Speed Amp to Molded	14/4	
30-1230-L48	Cord, Brown, P2, 2 Molded, Univ	14/4	
30-1230-L96	Cord, Brown, P2, 2 Molded, Univ	14/4	
09-0023C	Receptacle, Pump 2, 2 Speed, Molded/Colored	14/4	
30-0240-48-K	Cord, Pump, 1-Speed, Molded, 48"	14/3	 PINK
30-0240-96-K	Cord, Pump, 1-Speed, Molded, 96"	14/3	
30-1240-L6	Adapter Cord, 6", Pink, P2, 1 Speed Amp to Molded	14/3	
30-1240-L48	Cord, Pink, P2, 1 Molded, Univ	14/3	
30-1240-L96	Cord, Pink, P2, 1 Molded, Univ	14/3	
09-0024C-A	Receptacle, Pump 2, 1 Speed, Molded/Colored	14/3	
30-0250-48C-K	Cord, Gas, Molded/Colored, 48"	18/2	 WHITE
30-0250-96C	Cord, Gas, Molded/Colored, 96"	18/2	
09-0025C	Receptacle, Gas, Molded/Colored	18/2	
30-0260-48	Cord, Fiber Optic, Molded, 48"	18/4	 ORANGE
30-0260-96	Cord, Fiber Optic, Molded, 96"	18/4	
30-0260-L48	Cord, Fiber Optic, Molded, 48", Univ	18/4	
30-0260-L48UST	Cord, Fiber Optic, Molded, 48", UST01	18/4	
30-0260-L96	Cord, Fiber Optic, Molded, 96", Univ	18/4	
30-0260-L96A	Cord, Fiber Optic, Molded, 96", MxM	18/4	
09-0026C	Receptacle, Fiber Optic, Molded/Colored	18/4	
30-0270-48C-K	Cord, Hot ACC., Molded/Colored, 48"	18/3	 GREEN
30-0270-96C	Cord, Hot ACC., Molded/Colored, 96"	18/3	
30-1270-C6	Adapter Cord, 6", Green, ACC Amp to Molded	18/3	
09-0027C-A	Receptacle, Hot ACC., Molded/Colored	18/3	
30-0100A-30-K	Cord, Slide, Heater Power, Molded, 30"	12/3	 BLACK
30-0100A-60-K	Cord, VH, Heater Power, Molded, 60"	12/3	
09-0041A	Receptacle, VH, Molded/Colored	12/3	
30-0318-48	Cord, Univ, Amp Pins w/3&4 Pin Plugs, 48"	18/3	 UNIVERSAL
30-0318-96	Cord, Univ, Amp Pins w/3&4 Pin Plugs, 96"	18/3	
30-0324-48	Cord, Univ, Amp Pins w/3&4 Pin Plugs, 48"	14/3	
30-0324-96	Cord, Univ, Amp Pins w/3&4 Pin Plugs, 96"	14/3	
30-0326-48	Cord, Univ, Amp Pins w/4 Pin Plug, 48"	14/4	
30-0326-96	Cord, Univ, Amp Pins w/4 Pin Plug, 96"	14/4	
30-0016-K	Adapter, XM/XE to Amp, 120V		
30-0016A-K	Adapter, XM/XE to Amp, 240V		
39-0015-S	Cord, Adapter, 3 piece, 14/4, 14/3, 18/3, Kit		

PARTS

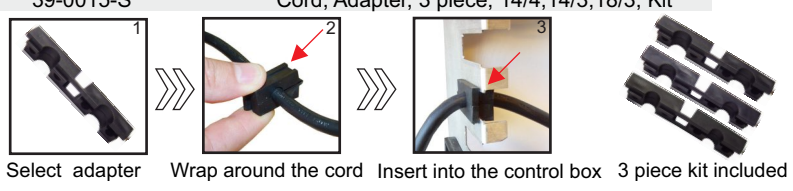





### PART NUMBER DESCRIPTION

12-0100-K	Heater Element, 5.5kW, 240V, 10" Incoloy
12-0100D-K	Heater Element, 5.5kW, 240V, 7" Incoloy
12-0100F-K	Heater Element, 5.5kW, 240V, 10" Titanium
12-0110G-K	Heater Element, 5.5kW, 240V, 7" Titanium
15-0033**	Base, 9X9, PBS/BES55-11
15-0033B**	Base, 9X9, BES 55/11
15-0037D**	Base, 14.5"X15", BES, 6000
26-0071-BAP-K***	Heater Assy, BCS/BES6000, 2.25", 5.5kW, Baptismal
26-0071-BAP-FA	Heater Assy, BCS/BES6000, 2.25", 5.5kW, Baptismal
42-0004-K	Drain, Suction/Return, 1.5"
42-0004A-K	Drain, Floor, 2" w/PVC Grid
42-0005-K	Pump Union, 1.5", w/O-Ring
42-0017-K	Tailpiece, 2" Htr X 2" Spig
42-0074-K	Wall Fitting, Slot, Auto-Fill
42-0074A-K	Wall Fitting, Drain, WL/OF
48-0001B	Header Assy for BES-6000/6005, 1.5" x 2", w/Gasket
48-0010C	Header Assy for PBES, w/Gasket
48-0029A	Header Assy for BES-6005, 11kW, heater to heater, Bap/Slide, w/Gasket
48-0072-K	Tailpiece w/Female Hose, 1.5", w/Gasket
48-0072A-K	Tailpiece w/ Male Hose, 1.5", w/Gasket
48-0072B-K	Tailpiece w/Female Hose, 2", w/Gasket
48-0072C-K	Tailpiece w/ Male Hose, 2", w/Gasket
48-0088	Header Assy for BES-6000, 5.5kW, pump to heater, 1.5" x 2", w/Gasket & O-Ring
48-0088A	Header Assy for BES-6005, 11kW, pump to heater, 1.5" x 2", w/Gasket & O-Ring
48-0146-K	Booster Heater Kit, 5.5kW ((Not Shown)
48-P250-PBES-LO	Htr Assy, 1.9", PBES, 2.0W, PSI (Not Shown)
48-P250-PBES-UP	Htr Assy, 1.9", PBES, 2.0W, PSI (Not Shown)
60-0015-K*	Gasket, 2" Ridged
60-0017-K*	Gasket, 1.5" Ridged
60-0020-K*	Gasket, 3" Ridged

\*\*\*Systems built before 2014



## PART NUMBER      DESCRIPTION

34-0002-K	Air Switch 125/250V, 25, SPDT
34-0012-K	High Limit, 250V, 30A, 5/16 Bulb, 24" Cap
34-0030-K	Thermostat, 250V, 30A, 5/16 Bulb, 24" Cap
34-0035-K	Timer, 7 Day, 120V, 60HZ, 21A, STD, w/Override Switch
34-0155-K	Pressure Switch, 120V, 5A, 1/8" Thread, For Baptismal Water Level
34-0178-K	Pressure Switch, 120V, 1A, 1/8" Thread, 1.50PSI (adjustable)
35-0003-K	Relay, SPDT, 15A, 240V, T-91
35-0012-K	Contactor, DPST, 120V, 30/40A
35-0014-K	Contactor, DPST, 120V, 50A
35-0019-K	Fuse, 30A, Main, SC-30
35-0028-K	Contactor, DPST, 240V, 40/50A
35-0037-K	Relay, DPST, 30A, 240V, T-92
35-0081-K	Fuse, 10AMP, Time Delay, 250VAC
36-0004A-K	Air Transmitter, White, #15, 1 1/4" Hole Size
36-0006A	Air Transmitter ,Chrome, #15, 1 1/4" Hole Size
42-0007B-K	Snap Nut, 2.0", Black
42-2333B-K	Nut, 3", Uni-Nut and Retainer
48-0152-S	<del>GFCI Replacement Kit, 5.5kW, OBSOLETE - Refer to PT# 48-0154 See Below</del>
48-0152A-S	<del>GFCI Replacement Kit, 11kW, OBSOLETE - Refer to PT# 48-0154 See Below</del>
48-0154	HC GFCI Removal Kit; 2 wire nuts, 2 hole plugs & wiring instructions
64-0001B	Tubing, 1/4" OD X 1/8" ID, Clear



\*Ball Valve



PT# 64-0012



PT# 64-0017



PT# 993-0262A-L48-S



PT# 993-0380-A6-S



PT# 10-0178-S



PT# 80-0132D-BES

## PART NUMBER

## DESCRIPTION

40-0008*	Valve, Ball 1 1/2", PVC
40-0009*	Valve, Ball 2", PVC
40-0010*	Valve, Ball 3/4" SxS, PVC
64-0012	Tubing, Long Distance, 1/8" OD X 1/16" ID, Clear
64-0017	Garden Hose, 15'
993-0262A-A48-S	Pump, Full Drain, 1/2HP, 1SPD, 120V, 3' Amp Cord
993-0262A-L48-S	Pump, Full Drain, 1/2HP, 1SPD, 120V, 48" Molded Cord
993-0262-A48-S	Obsolete, replaced by PT# 993-0262A-A48-S
993-0262-L-48-S	Obsolete, replaced by PT# 993-0262A-L48-S
993-0265-A48-S	Obsolete, replaced by PT# 993-0262A-A48-S
993-0265A-A48-S	Obsolete, replaced by PT# 993-0380A-A6-S
993-0265A-L48-S	Obsolete, replaced by PT# 993-0380A-A6-S
993-0265-L48-S	Obsolete, replaced by PT# 993-0262A-L48-S
993-0380-A6-S	Pump, 115V, 1SPD, Amp Pigtail Cord
993-0380A-A6-S	Pump, 230V, 1SPD, Amp Pigtail Cord
10-0178-S	Pump, Submersible, 1/6HP, 120V
80-0132D-BES	Label, TDI, HQ BES, 3 BTN



# Cross Reference



**HYDROQUIP™**  
THE **SMART CHOICE™**

Made in the USA

# Balboa® to HydroQuip Parts Cross Reference

BWG PT#	HQ PT#
10307	80-10307
10328	80-10328
10352	80-10352
10402	80-10402
10418	80-10418
10429	80-10429
10430	80-10430
10559	80-10559
10668	80-10668
10669	80-10669
10671	80-10671
10694	80-10694
10721	80-10721
10752	80-10752
10753	80-10753
10763	80-10763
10764	80-10764
10823	80-10823
10839	80-10839
10841	80-10841
11095	80-11095
11127	80-11127
11159	80-11159
11219	80-11219
11281	80-11281
11321	80-11321
11344	80-11344
11345	80-11345
11393	80-11393
11428	80-11428
11448	80-11448
11476	80-11476
11520	80-11520
11521	80-11521
11588-1	30-11588-25
11588-2	30-11588-50
11588-3	30-11588-100
11589-1	30-11589-25
11589-2	30-11589-50
11589-3	30-11589-100
11609	80-11609
11611	80-11611
11612	80-11612
11671	80-11671
11688	80-11688
11724	80-11724
11725	80-11725
11745	80-11745
11746	80-11746
11756	80-11756

BWG PT#	HQ PT#
11762	80-11762
11764	80-11764
11765	80-11765
11773	80-11773
11774	80-11774
11789	80-11789
11790	80-11790
11806	80-11806
11822	80-11822
11823	80-11823
11852	80-11852
11853	80-11853
11877	80-11877
11884	80-11884
11885	80-11885
11892	80-11892
11894	80-11894
11899	80-11899
11901	80-11901
11907	80-11907
11908	80-11908
11909	80-11909
11946	80-11946
11947	80-11947
11956	80-11956
11957	80-11957
11960	80-11960
11984	80-11984
12016	80-12016
12037	80-12037
12050	80-12050
12051	80-12051
12052	80-12052
12053	80-12053
12101	80-12101
12122	80-12122
12132	80-12132
12183	80-12183
12198	80-12198
12220	80-12220
12237	80-12237
12238	80-12238
12437	80-12437
12438	80-12438
12510	80-12510
12511	80-12511
12512	80-12512
12513	80-12513
12762	80-12762
12966	80-12966

BWG PT#	HQ PT#
12974	80-12974
12975	80-12975
21619	60-0015
22630	30-22630-100
22632	30-22632-50
22635	30-22635-25
25657	30-25657
25662-1	30-25662-25
25662-2	30-25662-50
25662-3	30-25662-100
30337	34-30337-K
30379	34-30379
30383	39-30383-K
30674	34-30674
32016	34-32016
40026	80-40026
40030	80-40030
40096	80-40096
40097	80-40097
40098	80-40098
40105	80-40105
50055	34-50055-K
50056	34-50056-K
50080	26-50080-K
50081	26-50081-K
50096	26-50096-K
50175	34-50175-K
50176	34-50176-K
50217	34-50217-K
50259	34-50259-K
50260	34-50260-K
50261	34-50261-K
50262	34-50262-K
50335	34-50335-K
50390	34-50390-K
50401	34-50401-K
50403	34-50403-K
51056	33-51056-K
51057	34-51057-K
51159	34-51159
51223	34-51223-K
51225	34-51225-K
51230	33-51230-K
51247	34-51247-K
51248	34-51248-K
51452	34-51452-K
51574	34-51574-K
51676	34-51676-K
51705	34-51705-K
52144	34-52144-K

**Cross Reference**

# Balboa® to HydroQuip Parts Cross Reference

BWG PT#	HQ PT#
52213	33-52213-K
52274	34-52274-K
52295	33-52295-K
52312	34-52312-K
52320	33-52320-K
52345	34-52345-K
52487	34-52487-K
52532	33-52532-K
52649	34-52649-K
52654	34-52654-K
52678	34-52678-K
52681	34-52681-K
52682	34-52682-K
52683	34-52683-K
52684	34-52684-K
52685	34-52685-K
52746	34-52746-K
52747	34-52747-K
53189	34-53189-K
53238	34-53238-K
53272	34-53272-K
53334	34-53334-K
53426	33-53426-K
53469	34-53469
53502	34-53502-K
53544	33-53544-K
53565	34-53565-K
53566	34-53566-K
53567	34-53567-K
53605	34-53605
53645	34-53645-K
53646	34-53646-K
53681	33-53681-K
53770	34-53770
53777	34-53777-K
53811	34-53811-K
53834-05	33-53834-K
53858-03	33-53858-K
54091	33-54091-K
54093	34-54093-K
54094	34-54094-K
54100	34-54100-K
54104	34-54104-K
54105	34-54105-K
54107	34-54107-K
54108	34-54108-K
54115	33-54115-K
54122	33-54122-K
54128	34-54128-K
54135	34-54135-K

BWG PT#	HQ PT#
54142	34-54142-K
54161	33-54161-K
54170	34-54170-K
54216	50-54216-Z
54217	50-54217-Z
54218	50-54218-Z
54219	50-54219-Z
54220	50-54220-Z
54251	34-54251-K
54268	34-54268-K
54356	51-54356-Z
54357-03	33-54357-K
54368	51-54368-Z
54369-03	33-54369-K
54371	51-54371-Z
54372-03	33-54372-K
54377	51-54377-Z
54383-04	33-54383-K
54385-03	33-54385-K
54446	33-54446-K
54528	34-54528-K
54547	34-54547-K
54548	34-54548-K
54589	34-54589-K
54646-01	33-54646-K
54652	34-54652-K
54664	34-54664-K
54665	34-54665-K
54681	34-54681-K
54685	34-54685-K
54716	34-54716-K
54726	34-54726-K
54805	51-54805-Z
54808	51-54808-Z
55049	34-55049-K
55050	34-55050-K
55051	34-55051-K
55080	34-55080-K
55081	34-55081-K
55123	34-55123-K
55129	34-55129-K
55137	33-55137-K
55151-01	33-55151-K
55152-01	33-55152-K
55299-01	33-55299-K
55304	34-55304-K
55349	34-55349-K
55350	34-55350-K
55390	34-55390-K
55431	34-55431-K

BWG PT#	HQ PT#
55456	34-55456-K
55487	34-55487-K
55532	34-55532-K
55533	34-55533-K
55536	34-55536-K
55559	34-55559-K
55563	34-55563-K
55570	34-55570-K
55580	34-55580-K
55600	34-55600-K
55602	33-55602-K
55609	34-55609
55673	34-55673-K
55693	34-55693-K
55840-01	33-55840-K
55936	34-55936-K
55989	34-55989-K
56007	51-56007-Z
56016	51-56016-Z
56297	33-56297-K
56298	51-56298-Z
56299	33-56299-K
56377	51-56377-Z
56380-02	33-56380-K
56473	51-56473-Z
56480	51-56480-Z
56483-03	33-56483-K
56485	51-56485-Z
56488-03	33-56488-K
56532	51-56532-Z
56582	51-56582-Z
56585	33-56585-K
58002	26-58002-K
58019	26-58019-K
58027	26-58027-K
58029	26-58029-K
58032	26-58032-K
58048	26-58048-K
58081	26-58081-K
58083	26-58083-K
58104	26-58104-K

**Cross Reference**

# Heater Assembly Cross Reference by Company Part Number

ITEM #	CO.	HQ PART #	kW	ITEM #	CO.	HQ PART #	kW
01781-27	D1	26-C3548-1-7T-F	5.5	20-00530	AT	27-J0413-7S-K	5.5
12077	HER	26-0315-5S-K	4.0	20-00540	AT	27-V310-5T-K	4.0
20-00224	AT	26-0002-7S-K	5.5	20-00542	AT	27-V310-4T-K	3.0
20-00227	AT	26-0056-7S-K	5.5	20-0320ET+	AT	27-V310-5T-K	4.0
20-00228	AT	27-J0413-7S-K	5.5	20-08574	AT	27-J0413-7S-K	5.5
20-00232	AT	27-J0413-7S-K	5.5	20138-001	SUN	26-0316-MP-KB	5.5
20-00242	AT	26-0800-5S-K	4.0	20-5011	AT	26-0314-5S-K	4.0
20-00242	AT	27-J0568-5S-K	4.0	22-00254	AT	48-9123-7T-K	5.5
20-00249	AT	26-0601-7S-K	5.5	22-00255	AT	48-9123-7T-K	5.5
20-00249	AT	27-J0568-7S-K	5.5	22-00256	AT	48-9123-7T-K	5.5
20-00250	AT	26-0601-7S-K	5.5	26-0003A	HQ	27-J0519-7S-K	5.5
20-00250	AT	27-J0568-7S-K	5.5	26-00100	TC	27-V310-7T-K	5.5
20-00251	AT	26-0601-7S-K	5.5	26-00107	TC	27-V310-7T-K	5.5
20-00251	AT	27-J0568-7S-K	5.5	26-00110	TC	27-V310-5T-K	4.0
20-00270	AT	26-0601-7S-K	5.5	26-00141	TC	27-V310-7T-K	5.5
20-00270	AT	27-J0568-7S-K	5.5	26-00155	TC	27-V310-5T-K	4.0
20-00271	AT	26-0601-5S-K	4.0	26-0017A	HQ	26-0082A-K	11.0
20-00271	AT	27-J0568-5S-K	4.0	26-00254	TC	27-V310-5T-K	4.0
20-00272	AT	26-0800-7S-K	5.5	26-00255	TC	27-V310-7T-K	5.5
20-00272	AT	27-J0568-7S-K	5.5	26-00257	TC	27-V310-5T-K	4.0
20-00274	AT	26-0800-7S-K	5.5	26-0031	HQ	26-0082-F-K	5.5
20-00274	AT	27-J0568-7S-K	5.5	26-0031	HQ	26-0082-K	5.5
20-00280	AT	26-0601-5S-K	4.0	26-0032	HQ	26-0071-K	5.5
20-00280	AT	27-J0568-5S-K	4.0	26-0032	HQ	27-J0519-7S-K	5.5
20-00281	AT	26-0601-5S-K	4.0	26-0032A	HQ	26-0071-K	5.5
20-00281	AT	27-J0568-5S-K	4.0	26-0032A	HQ	27-J0519-7S-K	5.5
20-00284	AT	26-0800-5S-K	4.0	26-0032-R1	HQ	48-260032-R1	5.5
20-00284	AT	27-J0568-5S-K	4.0	26-0032-R1C	HQ	26-0071-K	5.5
20-00285	AT	26-0800-5S-K	4.0	26-0032-R1C	HQ	27-J0519-7S-K	5.5
20-00285	AT	27-J0568-5S-K	4.0	26-0034-R1	HQ	48-260034-R1	4.5
20-00287C	AT	26-0309-3S-K	2.5	26-0035-7S-K	HQ	26-0035-7S-K	5.5
20-00292	AT	26-0601-5S-K	4.0	26-0036-R1C	HQ	26-0071B-K	4.0
20-00292	AT	27-J0568-5S-K	4.0	26-0036-R1C	HQ	27-J0519-5S-K	4.0
20-00294	AT	26-0601-5S-K	4.0	26-0047-R1	HQ	26-0047-K	4.5
20-00294	AT	27-J0568-5S-K	4.0	26-0058	HQ	26-0071-K	5.5
20-00296	AT	26-0601-5S-K	4.0	26-0058	HQ	27-J0519-7S-K	5.5
20-00296	AT	27-J0568-5S-K	4.0	26-0071	HQ	26-0071-K	5.5
20-00307	AT	26-0314-7S-K	5.5	26-0071	HQ	27-J0519-7S-K	5.5
20-00317	AT	26-0314-5S-K	4.0	26-0071B	HQ	26-0071B-K	4.0
20-00317	AT	27-J0413-5S-K	4.0	26-0071B	HQ	27-J0519-5S-K	4.0
20-00318	AT	27-J0413-5S-K	4.0	26-0807-4S-K	HQ	26-58118-K	3.0
20-00319	AT	27-J0413-7S-K	5.5	26-0807-4S-KS	HQ	26-58118-K	3.0
20-00324	AT	27-J0413-6S-K	4.5	26-0807-5S-K	HQ	26-58104-K	4.0
20-00328	AT	27-J0413-7S-K	5.5	26-0807-5S-KS	HQ	26-58104-K	4.0
20-00348	AT	26-0313N-7S-K	5.5	26-0807-7S-K	HQ	26-58083-K	5.5
20-00348-C	AT	26-0313N-7S-K	5.5	26-0807-7S-KS	HQ	26-58083-K	5.5
20-00354	AT	26-0456-5S-K	4.0	26-0809-5S-K	HQ	27-J0413-5S-K	4.0
20-00406	AT	26-0213N-7S-K	5.5	26-08102	TC	27-V310-5T-K	4.0
20-00406C	AT	26-0213N-7S-K	5.5	26-08103	TC	27-V310-7T-K	5.5
20-00410	AT	26-0601-5S-K	4.0	26-08106	TC	27-V310-7T-K	5.5
20-00410	AT	27-J0568-5S-K	4.0	26-08107	TC	27-V310-7T-K	5.5
20-00417	AT	26-0314-7S-K	5.5	26-08108	TC	27-V310-5T-K	4.0
20-00417	AT	27-J0413-7S-K	5.5	26-08109	TC	27-V310-5T-K	4.0
20-00424	AT	26-0002-7S-K	5.5	26-08112	TC	27-V310-7T-K	5.5
20-00425	AT	27-J0413-7S-K	5.5	26-08114	TC	27-V310-5T-K	4.0
20-00430	AT	26-0314-7S-K	5.5	26-08115	TC	27-V310-5T-K	4.0
20-00433	AT	26-0314-5S-K	4.0	26-08116	TC	27-V310-4T-K	3.0
20-00434	AT	26-0314-5S-K	4.0	26-08118	TC	27-V310-5T-K	4.0
20-00454	AT	26-0314-5S-K	4.0	26-08119	TC	27-V310-5T-K	4.0
20-00467	AT	26-1008-7S-K	5.5	26-08120	TC	27-V310-7T-K	5.5
20-00503	AT	27-J0413-7S-K	5.5	26-081214	TC	27-V310-5T-K	4.0
20-00514	AT	27-V310-5T-K	4.0	26-08125	TC	27-V310-7T-K	5.5
20-00517	AT	26-0517-MP-K	5.5	26-08145	TC	27-V310-5T-K	4.0
20-00530	AT	26-0736-7S-K	5.5	26-08146	TC	27-V310-5T-K	4.0

**Cross Reference**

ARC=Arctic Spas AT=Aquatemp BWG=Balboa CAL=Cal Spas CALD=Caldera CT=Correct Tech GK=Gecko HER=Hercules HQ=Hydro-Quip LNG=Laing MS=Marquis Spas PINN=Pinnacle SBSG=Spa Builders SC=Spa Components SUN=Sundance TP=Therm Products VIT=Vita WW=Waterway WAT=Watkins

Universal Rite-Fit Heaters Do Not Include: Sensors or Pressure Switches

# Heater Assembly Cross Reference by Company Part Number

ITEM #	CO.	HQ PART #	kW	ITEM #	CO.	HQ PART #	kW
26-08147	TC	27-V310-7T-K	5.5	50134	BWG	26-50096-K	5.5
26-08153	TC	27-V310-7T-K	5.5	50134	BWG	27-J0425-7S-K	5.5
26-08155	TC	27-V310-7T-K	5.5	50142	BWG	26-0535-5S-KP	4.0
26-08156	TC	27-V310-7T-K	5.5	50142	BWG	26-58081-K	4.0
26-08157	TC	27-V310-5T-K	4.0	50142	BWG	27-J0425-5S-K	4.0
26-08159	TC	27-V310-5T-K	4.0	50150	BWG	26-0535-7S-KP	5.5
26-08174	TC	28-E0300-5T-K	4.0	50150	BWG	26-50096-K	5.5
26-08175	TC	28-E0300-7T-K	5.5	50150	BWG	27-J0425-7S-K	5.5
26-08235	TC	27-V310-5T-K	4.0	53349	BWG	26-0809-5S-KSP	4.0
26-08245	TC	27-V310-5T-K	4.0	53349	BWG	26-58048-K	4.0
3314-1	TP	26-3314-1-7T-K	5.5	53349	BWG	27-J0425-5S-K	4.0
411092	VIT	26-1008-6S-K	4.5	55033	BWG	26-58104-K	4.0
411092	VIT	26-1008-6S-K	4.5	55033	BWG	27-J0425-5S-K	4.0
46-238-1700	CT	26-2300-5S-K	4.0	55035	BWG	26-58104-K	4.0
48-3300-00-00	PINN	26-0000ABX-7S-K	5.5	55035	BWG	27-J0425-5S-K	4.0
48-3300-10-002H	PINN	26-1002-7S-K	5.5	55881	BWG	26-58145-K	2.0
48-3300-10-003H	PINN	26-1002-7S-K	5.5	58000	BWG	26-58083-K	5.5
48-3300-10-013H	PINN	26-0213N-7S-K	5.5	58000	BWG	27-J0425-7S-K	5.5
48-3300-10-035H	PINN	26-0035-7S-K	5.5	58001	BWG	27-J0425-5S-K	4.0
48-3300-10-154H	PINN	26-0314-7S-K	5.5	58002	BWG	26-58083-K	5.5
48-3300-10-435H	PINN	26-0535-5S-K	4.0	58002	BWG	27-J0425-7S-K	5.5
48-3300-10-736H	PINN	26-0736-7S-K	5.5	58004	BWG	27-J0413-5S-K	4.0
48-3300-16	PINN	26-0002-7S-K	5.5	58009	BWG	26-0535-5S-KP	4.0
48-3300-40-001	PINN	27-V310-7T-K	5.5	58009	BWG	26-58081-K	4.0
48-3300-40-020	PINN	27-V310-7T-K	5.5	58009	BWG	27-J0425-5S-K	4.0
48-3300-40-101	PINN	27-V310-5T-K	4.0	58010	BWG	26-58083-K	5.5
48-330-10-304H	PINN	26-0314-7S-K	5.5	58010	BWG	27-J0425-7S-K	5.5
48-3600-10-002H	PINN	26-1002-5S-K-T	4.0	58013	BWG	26-0809-7S-KSP	5.5
48-3600-40-003	PINN	27-V310-5T-K	4.0	58015	BWG	26-50096-K	5.5
48-3600-40-004	PINN	27-V310-5T-K	4.0	58016	BWG	26-58083-K	5.5
48-3600-40-012	PINN	27-V310-5T-K	4.0	58016	BWG	27-J0425-7S-K	5.5
48-3600-40-014	PINN	27-V310-5T-K	4.0	58019	BWG	26-0809-7S-KSP	5.5
48-9120 (R1 - R6)	ARC	48-9120-7P-K	5.5	58019	BWG	26-58019-K	5.5
48-9120-K	ARC	48-9120-7P-K	5.5	58019	BWG	27-J0425-7S-K	5.5
48-9121(R1 - R4)	ARC	48-9121-7S-K	5.5	58026	BWG	26-0809-7S-KSP	5.5
48-9121-K	ARC	48-9121-7S-K	5.5	58026	BWG	26-58019-K	5.5
48-9123(R1 - R4)	ARC	48-9123-7T-K	5.5	58026	BWG	27-J0413-7S-K	5.5
48-9124(R1 - R3)	ARC	48-9124-AP-K	3.6	58026	BWG	27-J0425-7S-K	5.5
48-9125(R1)	ARC	48-9125-5T-K	4.0	58027	BWG	26-0809-7S-K	5.5
48-9130(R1 - R4)	ARC	48-9130-CP-K	7.2	58027	BWG	26-58027-K	5.5
48-9130-K	ARC	48-9130-CP-K	7.2	58027	BWG	27-J0413-7S-K	5.5
48-9150(R1 - R6)	ARC	48-9150-5P-K	4.0	58027	BWG	27-J0425-7S-K	5.5
48-9150-K	ARC	48-9150-5P-K	4.0	58028	BWG	26-0809-5S-KSP	4.0
48-9150-R2-S	ARC	48-9150-5P-K	4.0	58028	BWG	26-58048-K	4.0
48-9150-S	ARC	48-9150-5P-K	4.0	58028	BWG	27-J0425-5S-K	4.0
48-9151(R1 - R2)	ARC	48-9151-AP-K	3.6	58029	BWG	26-0809-5S-K	4.0
50067	BWG	26-0535-5S-KP	4.0	58029	BWG	26-58029-K	4.0
50067	BWG	26-58081-K	4.0	58029	BWG	27-J0413-5S-K	4.0
50071	BWG	26-0535-7S-KP	5.5	58029	BWG	27-J0425-5S-K	4.0
50071	BWG	26-50096-K	5.5	58031	BWG	26-58104-K	4.0
50071	BWG	27-J0425-7S-K	5.5	58031	BWG	27-J0425-5S-K	4.0
50076	BWG	26-0535-7S-KP	5.5	58032	BWG	26-58104-K	4.0
50076	BWG	26-50096-K	5.5	58032	BWG	26-58104-K	4.0
50076	BWG	27-J0425-7S-K	5.5	58032	BWG	27-J0425-5S-K	4.0
50080	BWG	26-0535-7S-K	5.5	58042	BWG	26-1001-5S-K	4.0
50080	BWG	26-50080-K	5.5	58048	BWG	26-0809-5S-KSP	4.0
50080	BWG	27-J0425-7S-K	5.5	58048	BWG	26-58048-K	4.0
50081	BWG	26-0535-5S-K	4.0	58048	BWG	27-J0425-5S-K	4.0
50081	BWG	26-50081-K	4.0	58056	BWG	26-58104-K	4.0
50081	BWG	27-J0425-5S-K	4.0	58056	BWG	27-J0425-5S-K	4.0
50096	BWG	26-0535-7S-KP	5.5	58061	BWG	26-58118-K	3.0
50096	BWG	26-50096-K	5.5	58064	BWG	26-58104-K	4.0
50096	BWG	27-J0425-7S-K	5.5	58064	BWG	27-J0425-5S-K	4.0
50134	BWG	26-0535-7S-KP	5.5	58066	BWG	26-0809-7S-KSP	5.5

Cross Reference

ARC=Arctic Spas AT=Aquatemp BWG=Balboa CAL=Cal Spas CALD=Caldera CT=Correct Tech GK=Gecko HER=Hercules HQ=Hydro-Quip LNG=Laing  
MS=Marquis Spas PINN=Pinnacle SBSG=Spa Builders SC=Spa Components SUN=Sundance TP=Therm Products VIT=Vita WW=Waterway WAT=Watkins

**Universal Rite-Fit Heaters Do Not Include: Sensors or Pressure Switches**



# Heater Assembly Cross Reference by Company Part Number

ITEM #	CO.	HQ PART #	kW	ITEM #	CO.	HQ PART #	kW
58066	BWG	26-58019-K	5.5	6595.1	LNG	26-3473-1-5T-K	4.0
58066	BWG	27-J0425-7S-K	5.5	6758	LNG	26-C3160-2S	4.0
58067	BWG	26-0809-5S-KSP	4.0	61443	LNG	26-C3548-1-7T-F	5.5
58067	BWG	26-58048-K	4.0	6000-155	SUN	26-1002-5S-K	4.0
58067	BWG	27-J0425-5S-K	4.0	6000-156	SUN	26-0056-7S-K	5.5
58069	BWG	26-0535-5S-KP	4.0	6500-062	SUN	26-3226-2A-BT-K	2.7
58069	BWG	26-58081-K	4.0	6500-063	SUN	26-3226-1A-5T-K	4.0
58069	BWG	27-J0425-5S-K	4.0	6500-310	SUN	26-3314-1-7T-K	5.5
58074	BWG	26-0809-7S-KSP	5.5	6500-315	SUN	26-3403-1-BT-K	2.7
58074	BWG	26-58019-K	5.5	6500-401	SUN	26-3478-1A-BT-K	2.7
58074	BWG	27-J0425-7S-K	5.5	6500-402	SUN	26-3229-2A-7T-K	5.5
58081	BWG	26-0535-5S-KP	4.0	6500-403	SUN	26-3229-2A-7T-K	5.5
58081	BWG	26-58081-K	4.0	6500-407	SUN	26-0556-7S-K	5.5
58081	BWG	27-J0425-5S-K	4.0	6HI-HL-120	HQ	BIS-15-120	1.5
58083	BWG	26-58083-K	5.5	6HI-HL-240	HQ	BIS-60-240	6.0
58083	BWG	27-J0425-7S-K	5.5	6HI/HL	HQ	BIS-60-240	6.0
58086	BWG	26-58083-K	5.5	7154	LNG	26-C3236-1A-5T-K	4.0
58086	BWG	27-J0425-7S-K	5.5	7211	LNG	26-C3160-1S	6.0
58089	BWG	26-58083-K	5.5	72494	WAT	26-3473-1-5T-K	4.0
58089	BWG	27-J0425-7S-K	5.5	72651	CALD	26-0800-5S-K	4.0
58103	BWG	26-58104-K	4.0	73009	WAT	26-C3548-1-7T-F	5.5
58103	BWG	27-J0425-5S-K	4.0	73039	WAT	26-C3160-2S	4.0
58104	BWG	26-58104-K	4.0	73039	WAT	26-C3160-2SA	4.0
58104	BWG	27-J0425-5S-K	4.0	73790	WAT	26-C3160-1S	6.0
58105	BWG	26-58083-K	5.5	73790	WAT	26-C3160-1SA	6.0
58105	BWG	27-J0425-7S-K	5.5	73791	WAT	26-C3160-2S	4.0
58106	BWG	26-58104-K	4.0	73791	WAT	26-C3160-2SA	4.0
58106	BWG	27-J0425-5S-K	4.0	73792	WAT	26-C3182-1S	1.5
58109	BWG	26-58104-K	4.0	73792	WAT	26-C3182-1SA	1.5
58109	BWG	27-J0425-5S-K	4.0	73994	CALD	26-3330-5S-K	4.0
58117	BWG	26-58104-K	4.0	74912	WAT	26-3473-1-5T-K	4.0
58117	BWG	27-J0425-5S-K	4.0	775-5001	WW	26-0808-7S-K	5.5
58118	BWG	26-58118-K	3.0	9920-100338	GK	26-0800-5S-K	4.0
58120	BWG	26-58104-K	4.0	9920-100338	GK	27-J0568-5S-K	4.0
58120	BWG	27-J0425-5S-K	4.0	9920-100339	GK	26-0800-7S-K	5.5
58121	BWG	26-58083-K	5.5	9920-100339	GK	27-J0568-7S-K	5.5
58121	BWG	27-J0425-7S-K	5.5	9920-100342	GK	27-J0568-4S-K	3.0
58123	BWG	26-58083-K	5.5	9920-100346	GK	26-0601-5S-K	4.0
58123	BWG	27-J0425-7S-K	5.5	9920-100346	GK	27-J0568-5S-K	4.0
58138	BWG	26-58138-K	1.5	9920-100347	GK	26-0601-7S-K	5.5
58145	BWG	26-58145-K	2.0	9920-100347	GK	27-J0568-7S-K	5.5
58148	BWG	26-58104-K	4.0	A2360-5100ET	TP	48-9124-AP-K	3.6
58148	BWG	27-J0425-5S-K	4.0	A2360-5200ET	TP	48-9124-AP-K	3.6
58198	BWG	26-58189-K	1.0	A2360-5250ET	TP	48-9124-AP-K	3.6
58198	BWG	26-58203-K	4.0	A2360-5251ET	TP	48-9124-AP-K	3.6
58203	BWG	26-58203-K	4.0	A2360-5350ET	TP	48-9122-AT-K	3.6
58209	BWG	26-58083-K	5.5	A2550-5100ET	TP	48-9123-7T-K	5.5
58209	BWG	27-J0425-7S-K	5.5	A2550-5200ET	TP	48-9123-7T-K	5.5
58212	BWG	26-58104-K	4.0	A2550-5250ET	TP	48-9123-7T-K	5.5
58212	BWG	27-J0425-5S-K	4.0	A2550-5251ET	TP	48-9123-7T-K	5.5
530AA0078	GK	26-0800-5S-K	4.0	A2550-5251ETX	TP	48-9123-7T-K	5.5
530AA0078	GK	27-J0568-5S-K	4.0	A2550-5300ET	TP	48-9121-7S-K	5.5
530AA0095	GK	26-0800-5S-K	4.0	A2550-5350ET	TP	48-9121-7S-K	5.5
530AA0095	GK	27-J0568-5S-K	4.0	AP-1	SBSG	26-0056-5S-K	4.0
530AA0107	GK	26-0800-7S-K	5.5	AP-4	SBSG	26-1002-5S-K-T	4.0
530AA0107	GK	27-J0568-7S-K	5.5	B12015N	SC	CALL	1.5
530AA0284	GK	26-0601-7S-K	5.5	B21100-1000	TP	CALL	11.0
530AA0284	GK	27-J0568-7S-K	5.5	B21100-1100	TP	CALL	11.0
530AA0293	GK	26-0601-5S-K	4.0	B21100-2012	TP	CALL	11.0
530AA0293	GK	27-J0568-5S-K	4.0	B21100-3000	TP	CALL	11.0
530AA0437	GK	26-0601-7S-K	5.5	B23020LA5	TP	27-J0568-2S-K	2.0
530AA0437	GK	27-J0568-7S-K	5.5	B23025R1	SC	26-0309-3S-K	2.5
6144	LNG	26-C3548-1-7T-F	5.5	B2400-0001	TP	CALL	4.0
6144.3	LNG	26-C3548-1-7T-F	5.5	B2400-2001(ET)(-1)	TP	CALL	5.5

**Cross Reference**

ARC=Arctic Spas AT=Aquatemp BWG=Balboa CAL=Cal Spas CALD=Caldera CT=Correct Tech GK=Gecko HER=Hercules HQ=Hydro-Quip LNG=Laing MS=Marquis Spas PINN=Pinnacle SBSG=Spa Builders SC=Spa Components SUN=Sundance TP=Therm Products VIT=Vita WW=Waterway WAT=Watkins

**Universal Rite-Fit Heaters Do Not Include: Sensors or Pressure Switches**

# Heater Assembly Cross Reference by Company Part Number

ITEM #	CO.	HQ PART #	KW	ITEM #	CO.	HQ PART #	KW
B2400-4000	TP	CALL	3.6	BAL50081	BWG	26-50081-K	4.0
B24040E	SC	26-0314-5S-K	4.0	BAL50081	BWG	27-J0425-5S-K	4.0
B24040GM	SC	26-0800-5S-K	4.0	C1100-0012	TP	CALL	1.0
B24040KX	SC	26-1004-5S-K	4.0	C1100-0216	TP	CALL	1.0
B24040LA5	SC	26-0601-5S-K	4.0	C1100-1200-1	TP	CALL	1.0
B24040LA5	SC	27-J0568-5S-K	4.0	C1100-5010-1	TP	CALL	1.0
B24040LB	SC	26-0535-5S-K	4.0	C1100-C2507-1	TP	CALL	1.0
B24040N	SC	26-0809-5S-K	4.0	C1140-5010-1	TP	CALL	1.4
B24040Q	SC	26-0056-5S-K	4.0	C2100-0210-1	TP	CALL	1.0
B24040R	SC	48-260036-R1	4.0	C21100-3077	TP	26-0054-K	11.0
B24040S	SC	27-J0425-5S-K	4.0	C2200-0056(ET)	TP	26-0056-2S-K	2.0
B24040T	SC	26-0809-5S-K	4.0	C2200-0056(ET)	TP	27-J0425-2S-K	2.0
B24040U	SC	26-0601-5S-K	4.0	C2200-0456	TP	27-J0413-2S-K	2.0
B24040U	SC	27-J0568-5S-K	4.0	C2200-0601(ET)	TP	26-0601-2S-K	2.0
B24040V	SC	CALL	4.0	C2200-0601(ET)	TP	27-J0568-2S-K	2.0
B24040W	SC	27-J0425-5S-K	4.0	C2200-0800(ET)	TP	26-0800-2S-K	2.0
B24040XL	SC	26-0011-5S-K	4.0	C2200-0800(ET)	TP	27-J0568-2S-K	2.0
B24040Y	SC	CALL	4.0	C2200-0800ET-G	TP	26-0800-2S-K	2.0
B24045G	SC	26-0056-6S-K	4.5	C2200-2300ET	TP	26-2300-2S-K	2.0
B24055A	SC	26-0314-7S-K	5.5	C2200-5000-1	TP	27-J0413-2S-K	2.0
B24055AR	SC	26-0314-7S-K	5.5	C2200-5003	TP	27-J0568-2S-K	2.0
B24055B	SC	26-0314-7S-K	5.5	C2250-0011	TP	26-0011-3S-K	2.5
B24055B-C	SC	26-0314-7S-K	5.5	C2250-0165	TP	26-0165-3S-K	2.5
B24055C	SC	26-0213N-7S-K	5.5	C2250-0309ET	TP	26-0309-3S-K	2.5
B24055C1	SC	26-0313N-7S-K	5.5	C2250-0309ET	TP	27-J0519-3S-K	2.5
B24055E	SC	26-0314-7S-K	5.5	C2250-0601(ET)	TP	26-0601-3S-K	2.5
B24055FF	SC	CALL	5.5	C2250-0601(ET)	TP	27-J0568-3S-K	2.5
B24055G	SC	27-J0425-7S-K	5.5	C2250-0736	TP	26-0736-3S-K	2.5
B24055GM	SC	26-0800-7S-K	5.5	C2250-0737	TP	27-J0425-3S-K	2.5
B24055GM	SC	27-J0568-7S-K	5.5	C2250-0800(ET)	TP	26-0800-3S-K	2.5
B24055K	SC	26-1004-7S-K	5.5	C2250-0800(ET)	TP	27-J0568-3S-K	2.5
B24055LA	SC	26-0601-7S-K	5.5	C2250-0802A	TP	26-0802A-2S-K	2.0
B24055LA	SC	27-J0568-7S-K	5.5	C2250-1002(ET)	TP	26-1002-3S-K	2.5
B24055LA2	SC	26-0736-7S-K	5.5	C2250-2001-1	TP	26-2001-3S-K	2.5
B24055LA5	SC	26-0601-7S-K	5.5	C2300-0010(ET)	TP	26-0010-4S-K	3.0
B24055LA5	SC	27-J0568-7S-K	5.5	C2300-0024(ET)	TP	26-0024-4S-K	3.0
B24055LASD	SC	26-0601-7S-K	5.5	C2300-0028ET	TP	26-0028-4S-K	3.0
B24055LASD	SC	27-J0568-7S-K	5.5	C2300-0028ET	TP	27-J0413-4S-K	3.0
B24055M	SC	27-J0425-7S-K	5.5	C2300-0056(ET)	TP	26-0056-4S-K	3.0
B24055MA	SC	27-J0425-7S-K	5.5	C2300-0056(ET)	TP	27-J0425-4S-K	3.0
B24055P	SC	CALL	5.5	C2300-0231N	TP	26-0213N-4S-K	3.0
B24055Q	SC	26-0056-7S-K	5.5	C2300-0309ET	TP	26-0309-4S-K	3.0
B24055S	SC	27-J0413-7S-K	5.5	C2300-0309ET	TP	27-J0519-4S-K	3.0
B24055SD	SC	CALL	5.5	C2300-0535-TPS	TP	26-0535-4S-KP	3.0
B24055T	SC	CALL	5.5	C2300-0800ET	TP	26-0800-4S-K	3.0
B24055U	SC	26-0601-7S-K	5.5	C2300-0800ET	TP	27-J0568-4S-K	3.0
B24055U	SC	27-J0568-7S-K	5.5	C2300-0807	TP	26-58118-K	3.0
B24055W	SC	27-J0425-7S-K	5.5	C2300-0807-TPS	TP	26-58118-K	3.0
B24055XL	SC	26-0011-7S-K	5.5	C2300-0809-TPS	TP	26-0809-4S-KP	3.0
B24055Y	SC	CALL	5.5	C2300-1002(ET)	TP	26-1002-4S-K	3.0
B2550-0206	TP	CALL	5.5	C2300-1008ET	TP	26-1008-4S-K	3.0
B2550-0216	TP	CALL	5.5	C2300-1206	TP	26-1206-5S-K	4.0
B2550-0306	TP	CALL	5.5	C2300-2300ET	TP	26-2300-4S-K	3.0
B2550-0316	TP	CALL	5.5	C2300-5000-1	TP	27-J0413-2S-K	2.0
B2550-08500	TP	CALL	5.5	C2300-5000-1Z	TP	27-J0413-2T-K	2.0
B2550-08540	TP	CALL	5.5	C2300-5000-1Z	TP	27-J0413-2T-K	2.0
B2550-1001	TP	CALL	5.5	C2300-5003	TP	27-J0568-4S-K	3.0
B2550-2000	TP	CALL	5.5	C2360-0601ET	TP	26-0601-AS-K	3.6
B2550-2000ET(-1)	TP	CALL	5.5	C2360-0601TI	TP	26-0601-KT-K	3.6
B2550-2001	TP	CALL	5.5	C2360-0800(ET)	TP	26-0800-AS-K	3.6
B2550-2001-1	TP	CALL	5.5	C2360-0800(ET)	TP	27-J0568-AS-K	3.6
B2550-3000	TP	CALL	5.5	C2360-1002(ET)	TP	26-1002-AS-K	3.6
B2550-4004	TP	CALL	5.5	C2400-0001	TP	26-0001-5S-K	4.0
BAL50081	BWG	26-0535-5S-K	4.0	C2400-0002/ET	TP	26-0002-5S-K	4.0

ARC=Arctic Spas AT=Aquatemp BWG=Balboa CAL=Cal Spas CALD=Caldera CT=Correatech GK=Gecko HER=Hercules HQ=Hydro-Quip LNG=Laing  
 MS=Marquis Spas PINN=Pinnacle SBSG=Spa Builders SC=Spa Components SUN=Sundance TP=Therm Products VIT=Vita WW=Waterway WAT=Watkins

**Universal Rite-Fit Heaters Do Not Include: Sensors or Pressure Switches**

Cross Reference

# Heater Assembly Cross Reference by Company Part Number

ITEM #	CO.	HQ PART #	KW	ITEM #	CO.	HQ PART #	KW
C2400-0011	TP	26-0011-5S-K	4.0	C2400-C2695-1	TP	26-3330-5S-K	4.0
C2400-0011(Ti)	TP	26-0011-F-PS-K	4.0	C2400-C2695-1	TP	27-J0568-5S-K	4.0
C2400-0024ET	TP	26-0024-5S-K	4.0	C2400-C3037-1	TP	26-H3037-5S-K	4.0
C2400-0027ET	TP	26-0028-5S-K	4.0	C2400-C3037-2	TP	26-H3037-5S-K	4.0
C2400-0028ET	TP	26-0028-5S-K	4.0	C2400-C3330-1A	TP	26-3330-5S-K	4.0
C2400-0028ET	TP	27-J0413-5S-K	4.0	C2400-C3330-1A	TP	27-J0568-5S-K	4.0
C2400-0056(ET)	TP	26-0056-5S-K	4.0	C2450-0010ET	TP	26-0010-6S-K	4.5
C2400-0056(ET)	TP	27-J0425-5S-K	4.0	C2450-0136-C	TP	CALL	4.5
C2400-0066ET-A	TP	27-J0413-5S-K	4.0	C2450-0165(ET)	TP	CALL	4.5
C2400-0073	TP	27-J0425-5S-K	4.0	C2450-0307(ET)	TP	48-260034-R1	4.5
C2400-0073-S	TP	27-J0425-5S-K	4.0	C2450-03101ET	TP	CALL	4.5
C2400-0103TT	TP	48-9150-5P-K	4.0	C2450-0521	TP	CALL	4.5
C2400-0165	TP	26-0165-5S-K	4.0	C2450-0802ET	TP	26-0802-6S-K	4.5
C2400-0213N	TP	26-0213N-5S-K	4.0	C2450-1004	TP	26-1004-6S-K	4.5
C2400-0256(ET)	TP	27-J0425-5S-K	4.0	C2450-1008ET	TP	26-1008-6S-K	4.5
C2400-0267(ET)	TP	27-J0519-5S-K	4.0	C2450-5000-1	TP	27-J0413-6S-K	4.5
C2400-0304(ET)	TP	26-0314-5S-K	4.0	C2500-3600ET-G	TP	CALL	5.0
C2400-0307(ET)	TP	26-0314-5S-K	4.0	C2550-0000A-BX	TP	26-0000ABX-7S-K	5.5
C2400-0313N	TP	26-0313N-5S-K	4.0	C2550-0002/ET	TP	26-0002-7S-K	5.5
C2400-0314(ET)	TP	26-0314-5S-K	4.0	C2550-0010	TP	26-0010-7S-K	5.5
C2400-0315	TP	26-0315-5S-K	4.0	C2550-0010	TP	27-J0413-7S-K	5.5
C2400-0321	TP	CALL	4.0	C2550-0011	TP	26-0011-7S-K	5.5
C2400-0456(ET)	TP	26-0056-5S-K	4.0	C2550-0011TI	TP	26-0011-F-RS-K	5.5
C2400-0517	TP	26-0517-5P-K	4.0	C2550-0014ET	TP	27-V310-7T-K	5.5
C2400-0535	TP	26-0535-5S-K	4.0	C2550-0021	TP	26-H0021-7S-K	5.5
C2400-0535	TP	26-50081-K	4.0	C2550-0021	TP	27-J0425-7S-K	5.5
C2400-0535	TP	27-J0425-5S-K	4.0	C2550-0022	TP	26-H0021-7S-K	5.5
C2400-0535-TPS	TP	26-0535-5S-KP	4.0	C2550-0023	TP	26-H0021-7S-K	5.5
C2400-0535-TPS	TP	26-58081-K	4.0	C2550-0024ET	TP	26-0024-7S-K	5.5
C2400-0535-TPS	TP	27-J0425-5S-K	4.0	C2550-0028ET	TP	26-0028-7S-K	5.5
C2400-0556	TP	26-0056-5S-K	4.0	C2550-0033	TP	CALL	5.5
C2400-0601(ET)	TP	26-0601-5S-K	4.0	C2550-0035	TP	26-0035-7S-K	5.5
C2400-0601(ET)	TP	27-J0568-5S-K	4.0	C2550-0036	TP	27-J0413-7S-K	5.5
C2400-0739ET	TP	26-0739-5SD-K	4.0	C2550-0056(ET)	TP	26-0056-7S-K	5.5
C2400-0800(ET)	TP	26-0800-5S-K	4.0	C2550-0056(ET)	TP	27-J0425-7S-K	5.5
C2400-0800(ET)	TP	27-J0568-5S-K	4.0	C2550-0065	TP	CALL	5.5
C2400-0802ET	TP	26-0802-5S-K	4.0	C2550-0066(ET)	TP	27-J0425-7S-K	5.5
C2400-0802ET	TP	27-J0425-5S-K	4.0	C2550-0071	TP	27-J0425-7S-K	5.5
C2400-0802ET	TP	27-J0568-5S-K	4.0	C2550-0073	TP	27-J0425-7S-K	5.5
C2400-0807	TP	26-58104-K	4.0	C2550-0103TT	TP	48-9120-7P-K	5.5
C2400-0807	TP	27-J0425-5S-K	4.0	C2550-0104	TP	CALL	5.5
C2400-0807-TPS	TP	26-58104-K	4.0	C2550-0108	TP	CALL	5.5
C2400-0807-TPS	TP	27-J0425-5S-K	4.0	C2550-0113	TP	26-0213N-7S-K	5.5
C2400-0809	TP	26-0809-5S-K	4.0	C2550-0119	TP	CALL	5.5
C2400-0809	TP	26-58029-K	4.0	C2550-0120	TP	CALL	5.5
C2400-0809	TP	27-J0425-5S-K	4.0	C2550-0136(ET-C)	TP	CALL	5.5
C2400-0809-TPS	TP	26-0809-5S-KSP	4.0	C2550-0154	TP	26-0155-7S-K	5.5
C2400-0809-TPS	TP	26-58048-K	4.0	C2550-0155	TP	26-0155-7S-K	5.5
C2400-0809-TPS	TP	27-J0425-5S-K	4.0	C2550-0157	TP	26-0155-7S-K	5.5
C2400-1002(ET)	TP	26-1002-5S-K-T	4.0	C2550-0165	TP	26-0165-7S-K	5.5
C2400-1004/TI	TP	26-1004-5S-K	4.0	C2550-0213N	TP	26-0213N-7S-K	5.5
C2400-1054	TP	26-0314-5S-K	4.0	C2550-0256(ET)	TP	27-J0425-7S-K	5.5
C2400-1206	TP	26-1206-5S-K	4.0	C2550-0267ET	TP	27-J0519-7S-K	5.5
C2400-1227	TP	26-1227-5S-K	4.0	C2550-0304(A/ET)	TP	26-0314-7S-K	5.5
C2400-2001	TP	26-2001-5S-K	4.0	C2550-0307ET	TP	48-260032-R1	5.5
C2400-2300ET	TP	26-2300-5S-K	4.0	C2550-0309(ET)	TP	26-0309-3S-K	2.5
C2400-2311	TP	CALL	4.0	C2550-0313N	TP	26-0313N-7S-K	5.5
C2400-2315ET	TP	CALL	4.0	C2550-0314	TP	26-0314-7S-K	5.5
C2400-5000-1	TP	27-J0413-5S-K	4.0	C2550-0314ET	TP	27-J0413-7S-K	5.5
C2400-5000-1Z	TP	27-J0413-5T-K	4.0	C2550-0316TI	TP	26-0316-MP-KB	5.5
C2400-5003	TP	27-J0568-5S-K	4.0	C2550-0321	TP	CALL	5.5
C2400-5010-1	TP	CALL	4.0	C2550-0435	TP	26-0535-7S-K	5.5
C2400-C2278-1	TP	26-C2278-1-5S-K	4.0	C2550-0456	TP	26-0056-7S-K	5.5
C2400-C2550-2	TP	CALL	4.0	C2550-0456	TP	27-J0413-7S-K	5.5

ARC=Arctic Spas AT=Aquatemp BWG=Balboa CAL=Cal Spas CALD=Caldera CT=Correct Tech GK=Gecko HER=Hercules HQ=Hydro-Quip LNG=Laing MS=Marquis Spas PINN=Pinnacle SBSG=Spa Builders SC=Spa Components SUN=Sundance TP=Therm Products VIT=Vita WW=Waterway WAT=Watkins

**Universal Rite-Fit Heaters Do Not Include: Sensors or Pressure Switches**

Call (951) 273-7575

Visit us at [hydroquip.com](http://hydroquip.com)

# Heater Assembly Cross Reference by Company Part Number

ITEM #	CO.	HQ PART #	KW	ITEM #	CO.	HQ PART #	KW
C2550-0517	TP	26-0517-MP-K	5.5	C3238-1A	TP	26-C3238-1A-7T-K	5.5
C2550-0521(-B)	TP	CALL	5.5	C3242-1A	TP	26-C3549-1-7T-K	5.5
C2550-0535	TP	26-0535-7S-K	5.5	C3264-2	TP	26-3264-2-DT-K	2.9
C2550-0535	TP	26-50080-K	5.5	C3314-1	TP	26-3314-1-7T-K	5.5
C2550-0535	TP	27-J0425-7S-K	5.5	C3314-1	TP	26-3314-1-7T-K	5.5
C2550-0535-TPS	TP	26-0535-7S-KP	5.5	C3473-1	TP	26-3473-1-5T-K	4.0
C2550-0535-TPS	TP	26-50096-K	5.5	C3474-1	TP	26-C3474-1-5T-K	4.0
C2550-0535-TPS	TP	27-J0425-7S-K	5.5	C3480-1	TP	26-C3480-1-7T-K	5.5
C2550-0537	TP	26-0535-7S-K	5.5	C3548-1	TP	26-C3548-1-7T-K	5.5
C2550-0556	TP	26-0056-7S-K	5.5	C3549-1	TP	26-C3549-1-7T-K	5.5
C2550-0556	TP	26-0556-7S-K	5.5	C3550-1	TP	26-C3550-1-7T-K	5.5
C2550-0601(ET)	TP	26-0601-7S-K	5.5	C3552-1	TP	26-C3552-1-7T-K	5.5
C2550-0601(ET)	TP	27-J0568-7S-K	5.5	C3554-1	TP	26-C3554-1-5T-K	4.0
C2550-0601(G)	TP	26-0601-7S-K	5.5	C3554-2	TP	26-C3554-2-5T-K	4.0
C2550-0621	TP	CALL	5.5	C3554-3	TP	26-C3554-3-5T-K	4.0
C2550-0735	TP	26-0535-7S-K	5.5	C3556-1	TP	26-C3556-1-7T-K	5.5
C2550-07352	TP	26-0535-7S-K	5.5	C3556-2	TP	26-C3556-2-5T-K	4.0
C2550-0735P	TP	26-0535-7S-KP	5.5	C3564-1	TP	26-C3160-1S	6.0
C2550-0736	TP	26-0736-7S-K	5.5	C3564-2	TP	26-C3160-2S	4.0
C2550-0739ET	TP	26-0739-7SD-K	5.5	F2250-0001	TP	26-0011-3S-K	2.5
C2550-0800(ET/G)	TP	26-0800-7S-K	5.5	F2250-0011	TP	26-0011-3S-K	2.5
C2550-0800(ET/G)	TP	27-J0568-7S-K	5.5	C2300-0517	TP	26-0517-4S-K	3.0
C2550-0802ET	TP	26-0802-7S-K	5.5	CR-IMER	HQ	BIS-15-120	1.5
C2550-0802ET	TP	27-J0568-7S-K	5.5	CR-IMER	HQ	BIS-60-240	6.0
C2550-0807	TP	26-58083-K	5.5	E2200-0001	TP	27-V310-2T-K	2.0
C2550-0807	TP	27-J0425-7S-K	5.5	E2200-0003	TP	27-V310-2T-K	2.0
C2550-0807-TPS	TP	26-58083-K	5.5	E2200-0004	TP	27-V310-2T-K	2.0
C2550-0807-TPS	TP	27-J0425-7S-K	5.5	E2200-0015(ET)	TP	27-V310-2T-K	2.0
C2550-0808	TP	26-0808-7S-K	5.5	E2200-0115(ET)	TP	27-V310-2T-K	2.0
C2550-0809	TP	26-58027-K	5.5	E2250-0012	TP	27-V310-2T-K	2.0
C2550-0809	TP	27-J0425-7S-K	5.5	E2250-0127ETX	TP	27-V310-2T-K	2.0
C2550-0809-1	TP	26-58027-K	5.5	E2250-0201(ET)	TP	27-V310-2T-K	2.0
C2550-0809-1	TP	27-J0425-7S-K	5.5	E2250-0202(ET)	TP	27-V310-2T-K	2.0
C2550-0809-TPS	TP	26-0809-7S-KSP	5.5	E2250-020X	TP	27-V310-2T-K	2.0
C2550-0809-TPS	TP	26-58019-K	5.5	E2270-0012	TP	27-V310-4T-K	3.0
C2550-0809-TPS	TP	27-J0425-7S-K	5.5	E2270-1000	TP	26-3403-1-BT-K	2.7
C2550-0814	TP	26-0814-7S-K	5.5	E2270-3314	TP	27-V310-4T-K	3.0
C2550-0V03-HT	TP	CALL	5.5	E2300-0012	TP	27-V310-4T-K	3.0
C2550-0V03K	TP	CALL	5.5	E2300-0126ET	TP	27-V310-4T-K	3.0
C2550-1002	TP	26-1002-7S-K	5.5	E2300-0127ET(X)	TP	27-V310-4T-K	3.0
C2550-1004TI	TP	26-1004-7S-K	5.5	E2300-0300ET	TP	28-E0300-4T-K	3.0
C2550-1004TI-1	TP	26-1004-7S-K	5.5	E2300-0301ET	TP	28-E0300-4T-K	3.0
C2550-1008ET	TP	26-1008-7S-K	5.5	E2300-0321	TP	27-V310-4T-K	3.0
C2550-1054	TP	27-J0413-7S-K	5.5	E2300-0321ET	TP	27-V310-4T-K	3.0
C2550-1056	TP	27-J0425-7S-K	5.5	E2300-0542ET	TP	27-V310-4T-K	3.0
C2550-1206	TP	26-1206-7S-K	5.5	E2400-0001	TP	27-V310-5T-K	4.0
C2550-1227	TP	26-1227-7S-K	5.5	E2400-0003	TP	27-V310-5T-K	4.0
C2550-2001	TP	26-2001-7S-K	5.5	E2400-0004	TP	27-V310-5T-K	4.0
C2550-2311	TP	CALL	5.5	E2400-0007	TP	27-V310-5T-K	4.0
C2550-2315	TP	CALL	5.5	E2400-0012	TP	27-V310-5T-K	4.0
C2550-3602ET-G	TP	CALL	5.5	E2400-0014(ET)	TP	27-V310-5T-K	4.0
C2550-5000-1	TP	27-J0413-7S-K	5.5	E2400-0015	TP	27-V310-5T-K	4.0
C2550-5000-1Z	TP	27-J0413-7T-K	5.5	E2400-0015ET	TP	27-V310-5T-K	4.0
C2550-5003	TP	27-J0568-7S-K	5.5	E2400-0021	TP	27-V310-5T-K	4.0
C2550-5010-1	TP	CALL	5.5	E2400-0021ET	TP	27-V310-5T-K	4.0
C2600-C1774-1	TP	CALL	6.0	E2400-0021ET-1	TP	27-V310-5T-K	4.0
C2783-1	TP	26-3314-1-7T-K	5.5	E2400-0021-NP	TP	27-V310-5T-K	4.0
C3160-1	TP	26-C3160-1S	6.0	E2400-0026	TP	27-V310-5T-K	4.0
C3160-2	TP	26-C3160-2S	4.0	E2400-0027	TP	27-V310-5T-K	4.0
C3182-1	TP	26-C3182-1S	1.5	E2400-0028C	TP	27-V310-5T-K	4.0
C3226-1A	TP	26-3226-1A-5T-K	4.0	E2400-0101(ET)	TP	27-V310-5T-K	4.0
C3229-1A	TP	26-3229-2A-7T-K	5.5	E2400-0114(ET)	TP	27-V310-5T-K	4.0
C3229-2A	TP	26-3229-2A-7T-K	5.5	E2400-0115(ET)	TP	27-V310-5T-K	4.0
C3236-1A	TP	26-C3236-1A-5T-K	4.0	E2400-0120C	TP	27-V310-5T-K	4.0

ARC=Arctic Spas AT=Aquatemp BWG=Balboa CAL=Cal Spas CALD=Caldera CT=Correct Tech GK=Gecko HER=Hercules HQ=Hydro-Quip LNG=Laing MS=Marquis Spas PINN=Pinnacle SBSG=Spa Builders SC=Spa Components SUN=Sundance TP=Therm Products VIT=Vita WW=Waterway WAT=Watkins

Universal Rite-Fit Heaters Do Not Include: Sensors or Pressure Switches

Cross Reference

# Heater Assembly Cross Reference by Company Part Number

ITEM #	CO.	HQ PART #	kW	ITEM #	CO.	HQ PART #	kW
E2400-0126ET	TP	27-V310-5T-K	4.0	HEA14100401	CAL	26-0011-7S-K	5.5
E2400-0127ET(X)	TP	27-V310-5T-K	4.0	HEA14100430	CAL	26-2001-7S-K	5.5
E2400-0201(ET)	TP	27-V310-5T-K	4.0	HEA14100470	CAL	26-0011-F-RS-K	5.5
E2400-0202-1	TP	27-V310-5T-K	4.0	IHH-4000-NHCW-6758	LNG	26-C3160-2S	4.0
E2400-0202ET	TP	27-V310-5T-K	4.0	IHH-4300-NHW-7340	LNG	26-3473-1-5T-K	4.0
E2400-0203(ET)	TP	27-V310-5T-K	4.0	IHH-6000-NHCW-6759	LNG	26-C3160-1S	6.0
E2400-0204(ET)	TP	27-V310-5T-K	4.0	IHH-6000-NHCW-7211.0	LNG	26-C3160-1S	6.0
E2400-0204ET	TP	27-V310-5T-K	4.0	IM120	HQ	BIS-15-120	1.5
E2400-0221	TP	27-V310-5T-K	4.0	IM120GFI	HQ	BIS-15-120	1.5
E2400-0300ET	TP	28-E0300-5T-K	4.0	IMER120V	HQ	BIS-15-120	1.5
E2400-0301ET	TP	28-E0300-5T-K	4.0	IM240	HQ	BIS-60-240	6.0
E2400-0320(ET)	TP	27-V310-5T-K	4.0	IM240GFI	HQ	BIS-60-240	6.0
E2400-0351(ET)	TP	27-V310-5T-K	4.0	IMER240V	HQ	BIS-60-240	6.0
E2400-0420ET	TP	27-V310-5T-K	4.0	KTLC-260A-036	HQ	BIS-60-240	6.0
E2400-0421ET	TP	27-V310-5T-K	4.0	LX-10	SBSG	26-1002-5S-K-T	4.0
E2400-0540ET	TP	27-V310-5T-K	4.0	LX-15	SBSG	26-0056-5S-K	4.0
E2400-1001	TP	26-1001-5S-K	4.0	MRQ740-0584	MS	26-C2278-1-5S-K	4.0
E2400-1127	TP	27-V310-5T-K	4.0	NHH-5500-NH-7328	LNG	26-C3550-1-7T-K	5.5
E2400-1127ET	TP	27-V310-5T-K	4.0	PEH-4326-NHW-6000	LNG	26-C3556-1-7T-K	5.5
E2450-0127ET/TX	TP	27-V310-6T-K	4.5	PEH5526-NH-6340	LNG	26-C3556-2-5T-K	4.0
E2450-1127ET	TP	27-V310-6T-K	4.5	PEH-5526-NH-6742	LNG	26-C3556-2-5T-K	4.0
E2550-0001	TP	27-V310-7T-K	5.5	PEH-5526-NHW-6388	LNG	26-C3556-1-7T-K	5.5
E2550-0012	TP	27-V310-7T-K	5.5	PEH-5526-NHW-6938	LNG	26-C3236-1A-5T-K	4.0
E2550-0014	TP	27-V310-7T-K	5.5	PEH-5556-NHW-6388	LNG	26-C3556-2-5T-K	4.0
E2550-0015	TP	27-V310-7T-K	5.5	SEH-4100-NHCW-7130	LNG	26-C3236-1A-5T-K	4.0
E2550-0015ET	TP	27-V310-7T-K	5.5	SEH-4100-NHCW-7130	LNG	26-C3236-1A-5T-K	4.0
E2550-0028C	TP	27-V310-7T-K	5.5	SEH-4300-NHCW-6699	LNG	26-3226-1A-5T-K	4.0
E2550-0029C	TP	27-V310-7T-K	5.5	SEH-4300-NHW-6595	LNG	26-3473-1-5T-K	4.0
E2550-0101(ET)	TP	27-V310-7T-K	5.5	SEH-5200-NH-6757	LNG	26-C3548-1-7T-F	5.5
E2550-0102ET	TP	27-V310-7T-K	5.5	SEH-5200-NH-6757	LNG	26-C3548-1-7T-K	5.5
E2550-0114(ET)	TP	27-V310-7T-K	5.5	SEH-5500-NH	LNG	26-C3548-1-7T-F	5.5
E2550-0115	TP	27-V310-7T-K	5.5	SEH-5500-NH	LNG	26-C3548-1-7T-K	5.5
E2550-0115ET	TP	27-V310-7T-K	5.5	SEH-5500-NH-6143	LNG	26-C3548-1-7T-F	5.5
E2550-0120C	TP	27-V310-7T-K	5.5	SEH-5500-NH-6143	LNG	26-C3548-1-7T-K	5.5
E2550-0155(ET)	TP	27-V310-7T-K	5.5	SEH-5500-NH-6144	LNG	26-C3548-1-7T-F	5.5
E2550-0202(ET)	TP	27-V310-7T-K	5.5	SEH-5500-NH-6144	LNG	26-C3548-1-7T-K	5.5
E2550-0202-1	TP	27-V310-7T-K	5.5	SEH-5500-NH-6698	LNG	26-3229-2A-7T-K	5.5
E2550-0202ET-1	TP	27-V310-7T-K	5.5	SEH-5500-NH-6699	LNG	26-3229-2A-7T-K	5.50
E2550-0203(ET)	TP	27-V310-7T-K	5.5	SEH-5500-NHC-6632	LNG	26-C3236-1A-5T-K	4.00
E2550-0204(ET)	TP	27-V310-7T-K	5.5	SEH-5500-NHC-7300	LNG	26-C3548-1-7T-F	5.50
E2550-020X(ET)	TP	27-V310-7T-K	5.5	SEH-5500-NHC-7300	LNG	26-C3548-1-7T-K	5.50
E2550-020X-1	TP	27-V310-7T-K	5.5	SEH-5500-NHCW-6938	LNG	26-C3238-1A-7T-K	5.50
E2550-020XET	TP	27-V310-7T-K	5.5	SEH-5500-NHW-6652	LNG	26-C3236-1A-5T-K	4.00
E2550-0300ET	TP	28-E0300-7T-K	5.5	SEH-5500-NHW-6676	LNG	26-C3236-1A-5T-K	4.00
E2550-0301ET	TP	28-E0300-7T-K	5.5	SEH-5500-NHW-7007	LNG	26-C3236-1A-5T-K	4.00
E2550-0320(ET)	TP	27-V310-7T-K	5.5	SEH550-NHC-7300	LNG	26-C3548-1-7T-K	5.50
E2550-0320ET+	TP	27-V310-7T-K	5.5	SEH-550-NHW-6692	LNG	26-C3236-1A-5T-K	4.00
E2550-0351(ET)	TP	27-V310-7T-K	5.5	SHH-5200-NH-6785	LNG	26-C3550-1-7T-K	5.50
E2550-0520-(TI)	TP	26-0520-7T-K	5.5	SHH-5500-NH-6727	LNG	26-C3549-1-7T-K	5.50
E2550-0520ET	TP	26-0520-7T-K	5.5	SHH-5500-NH-6739	LNG	26-C3236-1A-5T-K	4.00
E2550-1000	TP	26-3314-1-7T-K	5.5	SHH-5500-NH-6771	LNG	26-C3550-1-7T-K	5.50
E2550-3314	TP	27-V310-7T-K	5.5	SHH-5500-NH-6871	LNG	26-C3550-1-7T-K	5.50
F2400-0011	TP	26-0011-5S-K	4.0	SRA-6041	HQ	BIS-15-120	1.50
F2400-1001	TP	26-1001-5S-K	4.0	SS-6-42HL	HQ	BIS-60-240	6.00
F2400-1001	TP	26-1001-5S-K	4.0	SRA-6041	HQ	BIS-60-240	6.00
F2550-0001	TP	26-0011-7S-K	5.5	SRC-6041	HQ	BIS-60-240	6.00
F2550-0011	TP	26-0011-7S-K	5.5	TAT40013	HQ	BIS-15-120	1.50
F2550-4002	TP	26-C3554-3-5T-K	4.0	TLC-260A-036	HQ	BIS-60-240	6.00
HEA14100001	CAL	27-J0413-7S-K	5.5	TAT40017	HQ	BIS-60-240	6.00
HEA14100010	CAL	26-0165-3S-K	2.5	VIT411092	VIT	26-1008-6S-K	4.50
HEA14100120	CAL	26-0011-7S-K	5.5	VIT411092	VIT	26-1008-6S-K	4.50
HEA14100121	CAL	26-0011-7S-K	5.5	XL5.5	CAL	26-0011-7S-K	5.50
HEA14100131	CAL	26-0011-F-PS-K	4.0				
HEA14100300	CAL	26-0011-F-RS-K	5.5				

**Cross Reference**

ARC=Arctic Spas AT=Aquatemp BWG=Balboa CAL=Cal Spas CALD=Caldera CT=Correct Tech GK=Gecko HER=Hercules HQ=Hydro-Quip LNG=Laing MS=Marquis Spas PINN=Pinnacle SBSG=Spa Builders SC=Spa Components SUN=Sundance TP=Therm Products VIT=Vita WW=Waterway WAT=Watkins

**Universal Rite-Fit Heaters Do Not Include: Sensors or Pressure Switches**

# Heater Element Cross Reference By Company Part Number

ITEM #	HQ PART #
2-05-0115	12-1464-AC-K
25-0461	12-0300-K
25-0461-ET	12-0300-K
25-0461-1TE	Call
25-0461-1TI	Call
25-04676	Call
25-0469	Call
25-0469ET	Call
25-0469-TI	Call
25-0478ET	12-0303A-K
25-0481	Call
25-0483	Call
25-0483ET	Call
25-0483-TI	Call
25-0492-1	12-0302-K
25-0492-1ET	12-0302-K
25-0495ET	12-0010-K
25-0605-TI	Call
25-14010	Call
25-1461	Call
25-1463-430AC	12-1463-AC-K
25-1463-430BC	12-1463-BC-K
25-1464-430AC	12-1464-AC-K
25-1464-430BC	12-1464-BC-K
25-1465	Call
25-1467	12-0010A-K
25-1470-1	12-0010A-K
25-1470-1ET	12-0010A-K
25-1470-1PLO	12-0010A-K
25-1470ET-1PLO	12-0010A-K
25-1472ET	12-0010A-K
25-1472ET-1	12-0010A-K
25-1480	Call
25-1481	Call
25-1586-TI	Call
25-24042	Call
25-2477	Call
25-2477-9	Call
25-2602	12-0010A-K
25-3007-4	Call
25-3007-G	Call
25-3010	Call
25-3010-1	Call
25-3010-4	Call
25-3011	Call
25-3015-4	Call
25-3016	Call
25-3016-1.5	Call
25-3016PS	Call
25-3016PS-4	Call
25-3053	12-0110G-K
25-3053ET	12-0110G-K
25-34010	12-0600F-K
25-3550-11	Call
25-355Q-55	12-0600F-K
25-4009	Call
25-4009ET	Call
25-4009-TI	Call
25-4010ET	Call
25-4010L	Call
25-4011	Call
25-4011ET	Call
25-4017	Call
25-4018	Call
25-4020	Call
25-4026	12-0106-K
25-4026-BI	12-0106-K

ITEM #	HQ PART #
25-4026-BI-TI	12-0106F-K
25-4026-BIZ	12-0106F-K
25-4026ET	12-0106-K
25-4026ET-BI	12-0106-K
25-4026-TEP	12-0106F-K
25-4026-TI	12-0106F-K
25-4027	12-0105-K
25-4027-BI	12-0105-K
25-4027-BI-TI	12-0105F-K
25-4027ET-BI	12-0105-K
25-4028	12-0114F-K
25-4028ET	12-0114F-K
25-4031	12-0101-K
25-4031-BI	12-0101-K
25-4031-BI-TI	12-0101F-K
25-4031ET	12-0101-K
25-4031ET-BI	12-0101-K
25-4031-TEP	12-0101F-K
25-4031-TI	12-0101F-K
25-4033	12-0101-K
25-4033-BI	12-0101-K
25-4033-BI-TI	12-0101F-K
25-4033-ET	12-0101-K
25-4033ET-BI	12-0101-K
25-4033-TI	12-0101F-K
25-4034	12-0100-K
25-40341	12-0100-K
25-40341ET	12-0100-K
25-40341L	12-0100-K
25-40341L-ET	12-0100-K
25-40341L-TI	12-0100F-K
25-40341S	12-0100F-K
25-4034-BI	12-0100-K
25-4034-BI-TEP	12-0100F-K
25-4034-BI-TI	12-0100F-K
25-4034-BIX	12-0100-K
25-4034ET	12-0100-K
25-4034ET-BI	12-0100-K
25-4034ET-BIX	12-0100-K
25-4034-TEP	12-0100F-K
25-4034-TI	12-0100F-K
25-4035	Call
25-4035ET	Call
25-4036	12-0104-K
25-4036-BI	12-0104-K
25-4036-BI-TI	12-0104F-K
25-4036-BIZ	12-0104F-K
25-4036ET	12-0104-K
25-4036ET-BI	12-0104-K
25-4036-TEP	12-0104F-K
25-4036-TI	12-0104F-K
25-4041	12-0102-K
25-4041-BI	12-0102-K
25-4041-BI-TEP	12-0102F-K
25-4041-BI-TI	12-0102F-K
25-4041-BIX	12-0102-K
25-4041ET	12-0102-K
25-4041ET-BI	12-0102-K
25-4041ET-BIX	12-0102-K
25-4041S-TI	12-0102F-K
25-4041-TEP	12-0102F-K
25-4041-TI	12-0102F-K
25-4041-TITAN	12-0102F-K
25-4042-BI	12-0113G-K
25-4042-BI-TI	12-0113G-K
25-4042ET-BI	12-0113G-K
25-4075	Call

ITEM #	HQ PART #
25-4087	Call
25-4088	Call
25-4097	Call
25-4129	12-0113G-K
25-4129	12-0113G-K
25-4129ET	12-0113G-K
25-4129ET	12-0113G-K
25-4129-TI	12-0113G-K
25-4131	Call
25-4131ET	Call
25-4132	Call
25-4132ET	Call
25-41341L	12-0500-K
25-41341L-ET	12-0500-K
25-41361L	12-0504-K
25-41361L-ET	12-0504-K
25-41361L-TI	Call
25-41411L	12-0502-K
25-41411L-ET	12-0502-K
25-41411L-TI	Call
25-41412	Call
25-41412ET	Call
25-41412-TI	Call
25-4226	Call
25-4226ET	Call
25-4226-T1	Call
25-5010L	Call
25-5010L-ET	Call
25-5011L	Call
25-5011L-ET	Call
70-20025	Call
70-20030	Call
70-20041	Call
70-20041-TE	Call
70-20056	Call
70-20056-TE	Call
70-20056-T	Call
70-20100	Call
70-20100-T	Call
70-20102	Call
70-20102-TE	Call
70-20111	Call
70-20111-TE	Call
70-20128-T	Call
70-20205	12-0500-K
70-20218	Call
70-20218-TE	Call
70-20218-TEP	Call
70-20219	Call
70-20219-TE	Call
70-20219-TEP	Call
70-20226	12-0504-K
70-20340	12-0302-K
70-20355	12-0300-K
70-20620	12-0106-K
70-20620-TE	12-0106-K
70-20630	12-0104-K
70-20630-TE	12-0104-K
70-20636-TE	12-0103-K
70-20638	12-0102-K
70-20638-TE	12-0102-K
70-20640	12-0101-K
70-20640-TE	12-0101-K
70-20655	12-0100-K
70-20655-T	12-0100-K
70-20655-TE	12-0100-K
WAT31409	12-1463-BC-K
WAT31255	12-1464-BC-K

Cross Reference

# Laing Pump Cross Reference

Company Part #	Company	HQ Part #	Description
01512-321YU	D1	10-0121-K	E-10, 240V, 3/4" Barb, Laing Ecocirc
6305.9	SUN	10-0123-K	E-10, 240V, 1" Barb, Laing Ecocirc
6316.9	SUN	10-0123-K	E-10, 240V, 1" Barb, Laing Ecocirc
6619	SUN	10-0123-K	E-10, 240V, 1" Barb, Laing Ecocirc
73348	LNG	10-0107-K	E-14, 240V, 1-1/2" Threaded
73979	LNG	10-0121-K	E-10, 240V, 3/4" Barb, Laing Ecocirc
73989	LNG	10-0120-K	E-10, 120V, 3/4" Barb, Laing Ecocirc
73999	LNG	10-0125-K	E-10, 240V, 3/4" Thread, Laing Ecocirc
74009	LNG	10-0124-K	E-10, 120V, 3/4" Thread, Laing Ecocirc
74069	LNG	10-0122-K	E-10, 120V, 1" Barb, Laing Ecocirc
74079	LNG	10-0123-K	E-10, 240V, 1" Barb, Laing Ecocirc
74427	LNG	10-0102-K	E-5, 120/240V, 3/4" Barb
74428	LNG	10-0102-K	E-5, 120/240V, 3/4" Barb
6000-125	SUN	10-0121M-K	E10, 240V, 3/4" Barb, Laing Circ
6050U0010	LNG	10-0123-K	E-10, 240V, 1" Barb, Laing Ecocirc
6050U0011	LNG	10-0122-K	E-10, 120V, 1" Barb, Laing Ecocirc
6050U0013	LNG	10-0124-K	E-10, 120V, 3/4" Thread, Laing Ecocirc
6050U0014	LNG	10-0125-K	E-10, 240V, 3/4" Thread, Laing Ecocirc
6050U0015	LNG	10-0120-K	E-10, 120V, 3/4" Barb, Laing Ecocirc
6050U0016	LNG	10-0121-K	E-10, 240V, 3/4" Barb, Laing Ecocirc
6080C5031	LNG	10-0102-K	E-5, 120/240V, 3/4" Barb
6080U0007	LNG	10-0120M-K	E10, 120V, 3/4" Barb, Laing Circ
6080U0010	LNG	10-0121M-K	E10, 240V, 3/4" Barb, Laing Circ
6080U0014	LNG	10-0107-K	E-14, 240V, 1-1/2" Threaded
6080U0015	LNG	10-0107-K	E-14, 240V, 1-1/2" Threaded
6080U0016	LNG	10-0107-K	E-14, 240V, 1-1/2" Threaded
6500-035	SUN	10-0121M-K	E10, 240V, 3/4" Barb, Laing Circ
6500-038	SUN	10-0120M-K	E10, 120V, 3/4" Barb, Laing Circ
6500-460	SUN	10-0120M-K	E10, 120V, 3/4" Barb, Laing Circ
733886733488	LNG	10-0107-K	E-14, 240V, 1-1/2" Threaded
E10-NSHNDNN1W-01	LNG	10-0120M-K	E10, 120V, 3/4" Barb, Laing Circ
E10-NSHNDNN1W-02	LNG	10-0120-K	E-10, 120V, 3/4" Barb, Laing Ecocirc
E10-NSHNDNN2W-01	LNG	10-0121M-K	E10, 240V, 3/4" Barb, Laing Circ
E10-NSHNDNN2W-02	LNG	10-0121-K	E-10, 240V, 3/4" Barb, Laing Ecocirc
E10-NSHNDNN2W-08	LNG	10-0123-K	E-10, 240V, 1" Barb, Laing Ecocirc
E10-NSHNNN1W-19	LNG	10-0120-K	E-10, 120V, 3/4" Barb, Laing Ecocirc
E10-NSHNNN1W-19	LNG	10-0122-K	E-10, 120V, 1" Barb, Laing Ecocirc
E10-NSHNNN2W-20	LNG	10-0121-K	E-10, 240V, 3/4" Barb, Laing Ecocirc
E10-NSHNNN2W-20	LNG	10-0123-K	E-10, 240V, 1" Barb, Laing Ecocirc
E10-NSTNNN1W-19	LNG	10-0124-K	E-10, 120V, 3/4" Thread, Laing Ecocirc
E10-NSTNNN2W-20	LNG	10-0125-K	E-10, 240V, 3/4" Thread, Laing Ecocirc
E14-NSTNNN2W-10	LNG	10-0107-K	E-14, 240V, 1-1/2" Threaded
E3-NCHNNN3W-13	LNG	10-0102-K	E-5, 120/240V, 3/4" Barb
E3-NCHNNN3W-13-1/2"	LNG	10-0126-K	E-3, 100-240V, 1/2" Barb
E3-NCHNNN3W-13-3/4"	LNG	10-0102-K	E-5, 120/240V, 3/4" Barb

**Cross Reference**

## Laing Pump Cross Reference Cont'd

Company Part #	Company	HQ Part #	Description
LHB07100138	LNG	10-0121-K	E-10, 240V, 3/4" Barb, Laing Ecocirc
LHB07100139	LNG	10-0120-K	E-10, 120V, 3/4" Barb, Laing Ecocirc
LHB07100140	LNG	10-0125-K	E-10, 240V, 3/4" Thread, Laing Ecocirc
LHB07100141	LNG	10-0124-K	E-10, 120V, 3/4" Thread, Laing Ecocirc
LHB07100142	LNG	10-0123-K	E-10, 240V, 1" Barb, Laing Ecocirc
LHB07100143	LNG	10-0122-K	E-10, 120V, 1" Barb, Laing Ecocirc
LHB08100024	LNG	10-0102-K	E-5, 120/240V, 3/4" Barb
LMB07102983	LNG	10-0107-K	E-14, 240V, 1-1/2" Threaded
SD6500-035, 240	SUN	10-0121-K	E-10, 240V, 3/4" Barb, Laing Ecocirc
SM1212NHW-19, 120	LNG	10-0122-K	E-10, 120V, 1" Barb, Laing Ecocirc
SM1212NHW-19, 230	LNG	10-0123-K	E-10, 240V, 1" Barb, Laing Ecocirc
SM1212NHW-21, 120	LNG	10-0122-K	E-10, 120V, 1" Barb, Laing Ecocirc
SM1212NHW-21, 230	LNG	10-0123-K	E-10, 240V, 1" Barb, Laing Ecocirc
SM1212NHW-26, 120	LNG	10-0120-K	E-10, 120V, 3/4" Barb, Laing Ecocirc
SM1212NTW-26	LNG	10-0125-K	E-10, 240V, 3/4" Thread, Laing Ecocirc
SM1212NTW-26, 120	LNG	10-0124-K	E-10, 120V, 3/4" Thread, Laing Ecocirc
SM303NH 3/4" Barb	LNG	10-0102-K	E-5, 120/240V, 3/4" Barb
SM909NHW-14, 120	LNG	10-0120-K	E-10, 120V, 3/4" Barb, Laing Ecocirc
SM909NHW-14, 120	LNG	10-0120-K	E-10, 120V, 3/4" Barb, Laing Ecocirc
SM909NHW-14, 120	LNG	10-0122-K	E-10, 120V, 1" Barb, Laing Ecocirc
SM909NHW-14, 240	LNG	10-0121-K	E-10, 240V, 3/4" Barb, Laing Ecocirc
SM909NHW-18, 120	LNG	10-0120-K	E-10, 120V, 3/4" Barb, Laing Ecocirc
SM909NHW-18, 240	LNG	10-0121-K	E-10, 240V, 3/4" Barb, Laing Ecocirc
SM909NHW-26, 120	LNG	10-0120-K	E-10, 120V, 3/4" Barb, Laing Ecocirc
SM909NHW-26, 240	LNG	10-0121-K	E-10, 240V, 3/4" Barb, Laing Ecocirc
SM909NTW-14, 115V	LNG	10-0124-K	E-10, 120V, 3/4" Thread, Laing Ecocirc
SM909NTW-14, 240	LNG	10-0125-K	E-10, 240V, 3/4" Thread, Laing Ecocirc
SM909NTW-18, 115V	LNG	10-0124-K	E-10, 120V, 3/4" Thread, Laing Ecocirc
SM909NTW-18, 240	LNG	10-0125-K	E-10, 240V, 3/4" Thread, Laing Ecocirc
SM909NTW-26, 115V	LNG	10-0124-K	E-10, 120V, 3/4" Thread, Laing Ecocirc
SM909NTW-26, 240	LNG	10-0125-K	E-10, 240V, 3/4" Thread, Laing Ecocirc
SM959NHW-26, 240	LNG	10-0121-K	E-10, 240V, 3/4" Barb, Laing Ecocirc
X400825	MAS	10-0107-K	E-14, 240V, 1-1/2" Threaded

## Grundfos Pump Cross Reference

Pump Part #	HQ Part #	Pump Part #	HQ Part #
1-00-0184	10-0134	632514098893	10-0135
1030005	10-0134	632514098909	10-0134
1030007	10-0135	92007	10-0134
31842	10-0134	92009	10-0135
59896132	10-0134	9333-01	10-0134
59896137	10-0135	9333-02	10-0135
59896223	10-0134	LB303611	10-0134
59896291	10-0134	PMPUP1538SPA115	10-0134
59896292	10-0135	PMPUP1538SPA230	10-0135
59896336	10-0134	PU602394	10-0135
59896352	10-0134	PUGR1543115S	10-0134
59896865	10-0135	PUGR1543220S	10-0135



Part Number	Page	Part Number	Page	Part Number	Page	Part Number	Page	Part Number	Page
01-0005	8.31-8.33	10-0172-HQ	8.30	12-0118FF	8.2	15-0066	8.33	26-0071-BAP-FA	8.53
02-0053A	8.32-8.33	10-0173-HQ	8.30	12-0300-K	8.3	15-0067	8.33	26-0071-BAP-K	8.53
02-0055	8.50	10-0174-HQ	8.30	12-0302-K	8.3	15-0068	8.33	26-0071B-F-K	8.48
02-0100	8.31-8.34	10-0175-HQ	8.30	12-0303A-K	8.3	15-0068A	3.33	26-0071B-K	8.48
02-0101	8.31-8.33	10-0176-HQ	8.30	12-0307F-K	8.3	15-0089	8.32, 8.33	26-0071-F-5KSS-K	8.48
03-0017	8.31-8.34	10-0178-S	8.55	12-0308F-K	8.3	25-0002-K	8.19	26-0071-F-7KSS-K	8.48
09-0004	8.19	10-0178-S	8.29, 8.50	12-0309F-K	8.3	25-0002-LG	8.27	26-0071-F-K	8.48
09-0018C-A	8.52	10-0181-HQ	8.30	12-0500-K	8.3	25-21089-HQ-K	8.19	26-0071-F-M7-K	8.47
09-0019C-A	8.52	10-0182-HQ	8.30	12-0502-K	8.3	26-0000ABX-7S-K	8.39	26-0071-F-M7-KS	8.47
09-0020C-A	8.52	10-0183-HQ	8.30	12-0504-K	8.3	26-0000ABX-7T-K	8.39	26-0071-K	8.48
09-0021C-A	8.52	10-0185-HQ	8.30	12-0600F-K	8.3	26-0001-5S-K	8.37	26-0071-M7-K	8.47
09-0022C-A	8.52	10-0186-HQ	8.30	12-0601F-K	8.3	26-0002-3S-K	8.37	26-0071-M7-KS	8.47
09-0023C	8.52	10-0187-HQ	8.30	12-0602F-K	8.3	26-0002-4S-K	8.37	26-0079B-K	8.48
09-0024C-A	8.52	10-0188-HQ	8.30	12-0604F-K	8.3	26-0002-7S-K	8.37	26-0079-K	8.48
09-0025C	8.52	10-0189-HQ	8.30	12-0606F-K	8.3	26-0010-4S-K	8.36	26-0082A-F-K	8.49
09-0026C	8.52	10-0190-HQ	8.30	12-1463-AC-K	8.3	26-0010-4T-K	8.36	26-0082A-K	8.49
09-0027C-A	8.52	10-0192-HQ	8.30	12-1463-BC-K	8.3	26-0010-6S-K	8.36	26-0082-F-K	8.49
09-0041A	8.52	10-0194-HQ	8.30	12-1464-AC-K	8.3	26-0010-6T-K	8.36	26-0082-K	8.49
09-0044B-K	8.21	10-0196-HQ	8.30	12-1464-BC-K	8.3	26-0011-3S-K	8.36	26-0155-7S-K	8.37
09-0044-K	8.21	10-0197-HQ	8.30	15-0031	8.50	26-0011-5S-K	8.36	26-0165-3S-K	8.36
09-0044-K	8.21	10-0200-3M	8.29	15-0033	8.53	26-0011-7S-K	8.36	26-0165-3T-K	8.36
10-0074A	8.31-8.34	10-0201-3M	8.29	15-0033B	8.53	26-0011-F-PS-K	8.36	26-0165-5S-K	8.36
10-0093	8.28	10-0202-3M	8.29	15-0034	8.23	26-0011-F-RS-K	8.36	26-0165-5T-K	8.36
10-0102-K	8.28	10-0203-3M	8.29	15-0036A	8.31-8.34	26-0024-4S-K	8.36	26-0165-7S-K	8.36
10-0107-K	8.28	10-0204-3M	8.29	15-0037A	8.23	26-0024-4T-K	8.36	26-0165-7T-K	8.36
10-0110	8.28	10-0205	8.29	15-0037B	8.23	26-0028-4S-K	8.36	26-0213N-4S-K	8.38
10-0110A	8.28	10-0206	8.29	15-0037D	8.53	26-0028-5S-K	8.36	26-0213N-5S-K	8.38
10-0111	8.28	10-0207	8.29	15-0043	8.34	26-0035-7S-K	8.35	26-0213N-7S-K	8.38
10-0111A	8.28	10-0210-3M	8.29	15-0044A	8.34	26-0035-7T-K	8.35	26-0309-3S-K	8.37
10-0120-K	8.28	10-0215-3M	8.29	15-0045A	8.31	26-0047-K	8.47	26-0309-4S-K	8.37
10-0120M-K	8.28	10-0220	8.29	15-0046	8.31	26-0053-F-M7-KS	8.49	26-0313N-5S-K	8.38
10-0121-A-K	8.28	10-0221	8.29	15-0049	8.31	26-0053-F-Y-KS	8.49	26-0313N-7S-K	8.38
10-0121F-K	8.28	10-0262A	8.29	15-0050	8.31	26-0053-K	8.49	26-0314-5S-K	8.35
10-0121-K	8.28	11-0002	8.29	15-0051	8.31	26-0054AF-M7-KS	8.49	26-0314-5T-K	8.35
10-0121M-K	8.28	11-0003	8.29	15-0051A	8.34	26-0054A-K	8.49	26-0314-7S-K	8.35
10-0122-K	8.28	12-0010A-K	8.2	15-0052	8.31	26-0054-F-Y-KS	8.49	26-0314-7T-K	8.35
10-0123-K	8.28	12-0010-K	8.2	15-0052A	8.34	26-0054-K	8.49	26-0315-5S-K	8.37
10-0124-K	8.28	12-0100D-K	8.53	15-0052B1-K	8.33	26-0056-2S-K	8.38	26-0315-5T-K	8.37
10-0125-K	8.28	12-0100F-K	8.2, 8.53	15-0052B-K	8.33	26-0056-2T-K	8.38	26-0316-AP-KB	8.38
10-0126-K	8.28	12-0100-K	8.2, 8.53	15-0052C	8.32	26-0056-3S-K	8.38	26-0316-MP-KB	8.38
10-0127-K	8.28	12-0101F-K	8.2	15-0053A	8.34	26-0056-3T-K	8.38	26-0517-4P-K	8.36
10-0134	8.28	12-0101-K	8.2	15-0053B-K	8.33	26-0056-4S-K	8.38	26-0517-5P-K	8.36
10-0135	8.28	12-0102F-K	8.2	15-0053C	8.32	26-0056-4T-K	8.38	26-0517-MP-K	8.36
10-0136-K	8.28	12-0102-K	8.2	15-0053-K	8.31	26-0056-5S-K	8.38	26-0520-7T-K	8.38
10-0137-K	8.28	12-0104F-K	8.2	15-0054A	8.34	26-0056-5T-K	8.38	26-0535-4S-K	8.35
10-0152-HQ	8.30	12-0104-K	8.2	15-0054B-K	8.33	26-0056-7S-K	8.38	26-0535-5S-K	8.35
10-0153-HQ	8.30	12-0105F-K	8.2	15-0055	8.31	26-0056-7T-K	8.38	26-0535-5S-KP	8.35
10-0162-HQ	8.30	12-0105-K	8.2	15-0056	8.31	26-0063-XD-K	8.49	26-0535-5S-KP01	8.35
10-0163-HQ	8.30	12-0106F-K	8.2	15-0057	8.31	26-0063-XD-KP	8.49	26-0535-5T-K	8.35
10-0164-HQ	8.30	12-0106-K	8.2	15-0058	8.31	26-0063-XD-KS	8.49	26-0535-5T-KP	8.35
10-0165-HQ	8.30	12-0107-K	8.2	15-0059	8.31	26-0063-Y	8.49	26-0535-7S-K	8.35
10-0166-HQ	8.30	12-0110G-K	8.2, 8.53	15-0060A-K	8.34	26-0066-KIT-FS	8.49	26-0535-7S-KP	8.35
10-0167-HQ	8.30	12-0111F-K	8.2	15-0060B-K	8.33	26-0066-KIT-PS	8.49	26-0535-7S-KP01	8.35
10-0168-HQ	8.30	12-0112F-K	8.2	15-0060C	8.32	26-0071-5KSS-K	8.48	26-0535-7T-K	8.35
10-0169-HQ	8.30	12-0113G-K	8.2	15-0061A	8.32	26-0071-7KSS-K	8.48	26-0535-7T-KP	8.35
10-0170-HQ	8.30	12-0114F-K	8.2	15-0062	8.32	26-0071A-F-K	8.48	26-0556-7S-K	8.38
10-0171-HQ	8.30	12-0116F-K	8.2	15-0064B-K	8.33	26-0071A-K	8.48	26-0556-7T-K	8.38

Part Number	Page	Part Number	Page	Part Number	Page	Part Number	Page	Part Number	Page
26-0601-2S-K	8.37	26-1002-AT-K	8.38	26-3P0-00A-1B03	8.51	26-85M-S00-1F03	8.47	26-C63-050-0G00	8.48
26-0601-2T-K	8.37	26-1004-7S-K	8.35	26-3Q0-00A-1B03	8.51	26-860-000-1B03	8.51	26-C70-000-1B03	8.51
26-0601-3S-K	8.37	26-1004-7T-K	8.35	26-3R0-00A-1B03	8.51	26-86B-000-1PP3	8.48	26-CA0-000-1B03	8.51
26-0601-3T-K	8.37	26-1008-4S-K	8.37	26-50080-K	8.40	26-86B-080-1PM3	8.47	26-CJ0-00A-1B03	8.51
26-0601-5S-K	8.37	26-1008-4T-K	8.37	26-50081-K	8.40	26-86B-S00-1FP3	8.48	26-CK0-00A-1B03	8.51
26-0601-5T-K	8.37	26-1008-6S-K	8.37	26-50096-K	8.40	26-86B-S80-1FM3	8.47	26-CL0-00A-1B03	8.51
26-0601-7S-K	8.37	26-1008-6T-K	8.37	26-58002-K	8.40	26-86M-000-1P03	8.47	26-CM0-00A-1B03	8.51
26-0601-7T-K	8.37	26-1008-7S-K	8.37	26-58019-K	8.40	26-870-000-1B03	8.51	26-CP0-00A-1B03	8.51
26-0601PT-K	8.37	26-1008-7T-K	8.37	26-58027-K	8.40	26-87B-000-1PP3	8.48	26-CQ0-00A-1B03	8.51
26-0736-3S-K	8.37	26-1206-4S-K	8.39	26-58029-K	8.40	26-87B-080-1PM3	8.47	26-CR0-00A-1B03	8.51
26-0736-7S-K	8.37	26-1206-4T-K	8.39	26-58032-K	8.40	26-87B-S00-1FP3	8.48	26-H*0-000-1J03	8.51
26-0739-5SD-K	8.38	26-1206-5S-K	8.39	26-58048-K	8.40	26-87B-S80-1FM3	8.47	26-H*0-00A-1J03	8.51
26-0739-5TD-K	8.38	26-1206-5T-K	8.39	26-58081-K	8.40	26-87M-000-1P03	8.47	26-H0021-7S-K	8.36
26-0739-7SD-K	8.38	26-1206-7S-K	8.39	26-58083-K	8.40	26-87M-S00-1F03	8.47	26-H0136-6S-K	8.35
26-0739-7TD-K	8.38	26-1206-7T-K	8.39	26-58104-K	8.40	26-8A0-000-1B03	8.51	26-H3037-5S-K	8.38
26-0800-2S-K	8.37	26-1227-5S-K	8.39	26-58118-K	8.40	26-8J0-00A-1B03	8.51	26-HD0-000-1J03	8.51
26-0800-2T-K	8.37	26-1227-5T-K	8.39	26-58138-K	8.40	26-8K0-00A-1B03	8.51	26-HD0-00A-1J03	8.51
26-0800-3S-K	8.37	26-1227-7S-K	8.39	26-58198-K	8.40	26-8L0-00A-1B03	8.51	26-J20-000-1B03	8.51
26-0800-3T-K	8.37	26-1227-7T-K	8.39	26-58203-K	8.40	26-8M0-00A-1B03	8.51	26-J30-000-1B03	8.51
26-0800-4S-K	8.37	26-2001-3S-K	8.36	26-58388-5T-ATE	8.41	26-8P0-00A-1B03	8.51	26-J40-000-1B03	8.51
26-0800-5S-K	8.37	26-2001-3T-K	8.36	26-65B-000-1PP3	8.48	26-8PB-000-1PP3	8.48	26-J50-000-1B03	8.51
26-0800-5T-K	8.37	26-2001-5S-K	8.36	26-65B-080-1PM3	8.47	26-8PB-080-1PM3	8.47	26-J60-000-1B03	8.51
26-0800-7S-K	8.37	26-2001-5T-K	8.36	26-65B-S00-1FP3	8.48	26-8PB-S00-1FP3	8.48	26-J70-000-1B03	8.51
26-0800-7T-K	8.37	26-2001-7S-K	8.36	26-65B-S80-1FM3	8.47	26-8PB-S80-1FM3	8.47	26-JA0-000-1B03	8.51
26-0800-AT-K	8.37	26-2001-7T-K	8.36	26-66B-000-1PP3	8.48	26-8PM-000-1P03	8.47	26-JJ0-00A-1K03	8.51
26-0802-5S-K	8.37	26-2300-2S-K	8.36	26-66B-080-1PM3	8.47	26-8Q0-00A-1B03	8.51	26-JK0-00A-1K03	8.51
26-0802-5T-K	8.37	26-2300-2T-K	8.36	26-66B-S00-1FP3	8.48	26-8QB-000-1PP3	8.48	26-JL0-00A-1K03	8.51
26-0802-6S-K	8.37	26-2300-4S-K	8.36	26-66B-S80-1FM3	8.47	26-8QB-080-1PM3	8.47	26-JM0-00A-1K03	8.51
26-0802-6T-K	8.37	26-2300-4T-K	8.36	26-67B-000-1PP3	8.48	26-8QB-S00-1FP3	8.48	26-JP0-00A-1K03	8.51
26-0802-7S-K	8.37	26-2300-5S-K	8.36	26-67B-080-1PM3	8.47	26-8QB-S80-1FM3	8.47	26-JQ0-00A-1K03	8.51
26-0802-7T-K	8.37	26-2300-5T-K	8.36	26-67B-S00-1FP3	8.48	26-8QM-S00-1F03	8.47	26-JR0-00A-1K03	8.51
26-0802A-3S-K	8.37	26-320-000-1B03	8.51	26-67B-S80-1FM3	8.47	26-8R0-00A-1B03	8.51	26-K20-000-1B03	8.51
26-0802A-5S-K	8.37	26-3226-1A-5T-K	8.41	26-67M-000-1PP3	8.48	26-8RB-000-1PP3	8.48	26-K30-000-1B03	8.51
26-0802A-6S-K	8.37	26-3226-2A-BT-K	8.41	26-67M-S00-1F03	8.47	26-8RB-080-1PM3	8.47	26-K40-000-1B03	8.51
26-0808-5SD-K	8.39	26-3226-2A-DT-K	8.41	26-6PB-000-1PP3	8.48	26-8RB-S00-1FP3	8.48	26-K50-000-1B03	8.51
26-0808-5TD-K	8.39	26-3226-4A-ET-K	8.41	26-6PB-080-1PM3	8.47	26-8RB-S80-1FM3	8.47	26-K5B-050-1PP3	8.48
26-0808-7SD-K	8.39	26-3229-2A-7T-K	8.41	26-6PB-S00-1FP3	8.48	26-8RM-000-1P03	8.47	26-K6B-S50-1FP3	8.48
26-0808-7TD-K	8.39	26-3236-1A-5T-K	8.40	26-6PB-S80-1FM3	8.47	26-8RM-S00-1F03	8.47	26-K60-000-1B03	8.51
26-0809-5S-K	8.36	26-3236-2A-BT-K	8.40	26-6QB-000-1PP3	8.48	26-C20-000-1B03	8.51	26-K6B-050-1PP3	8.48
26-0809-5S-KSP	8.36	26-3238-1A-7T-K	8.40	26-6QB-S00-1FP3	8.48	26-C2278-1-5S-K	8.38	26-K6B-S50-1FP3	8.48
26-0809-5T-K	8.36	26-3264-2-DT-K	8.41	26-6QB-S80-1FM3	8.47	26-C30-000-1B03	8.51	26-K70-000-1B03	8.51
26-0809-5T-KSP	8.36	26-330-000-1B03	8.51	26-6QB-S80-1PM3	8.47	26-C3160-1S	8.39	26-K7B-050-1PP3	8.48
26-0809-7S-K	8.36	26-3314-1-7T-K	8.41	26-6RB-000-1PP3	8.48	26-C3160-2S	8.39	26-K7B-S50-1FP3	8.48
26-0809-7S-KSP	8.36	26-3330-5S-K	8.36	26-6RB-080-1PM3	8.47	26-C3182-1S	8.39	26-KA0-000-1B03	8.51
26-0809-7T-K	8.36	26-3330-5T-K	8.36	26-6RB-S00-1FP3	8.48	26-C3474-1-5T-K	8.41	26-KJ0-00A-1B03	8.51
26-0809-7T-KSP	8.36	26-340-000-1B03	8.51	26-6RB-S80-1FM3	8.47	26-C3548-1-7T-F	8.41	26-KK0-00A-1B03	8.51
26-0814-7S-K	8.39	26-3403-1-BT-K	8.41	26-6RM-000-1PP3	8.48	26-C3548-1-7T-K	8.41	26-KL0-00A-1B03	8.51
26-0814-7T-K	8.39	26-3473-1-5T-K	8.41	26-6RM-S00-1F03	8.47	26-C3549-1-7T-K	8.40	26-KM0-00A-1B03	8.51
26-1001-5S-K	8.38	26-3478-1A-BT-K	8.41	26-820-000-1B03	8.51	26-C3550-1-7T-K	8.41	26-KP0-00A-1B03	8.51
26-1002-3S-K	8.38	26-350-000-1B03	8.51	26-830-000-1B03	8.51	26-C3552-1-7T-K	8.47	26-KPB-050-1PP3	8.48
26-1002-3T-K	8.38	26-360-000-1B03	8.51	26-840-000-1B03	8.51	26-C3554-2-BT-K	8.40	26-KPB-S50-1FP3	8.48
26-1002-4S-K	8.38	26-370-000-1B03	8.51	26-850-000-1B03	8.51	26-C3554-3-5T-K	8.40	26-KQ0-00A-1B03	8.51
26-1002-4T-K	8.38	26-3A0-000-1B03	8.51	26-85145-K	8.40	26-C3556-1-7T-K	8.41	26-KQB-050-1PP3	8.48
26-1002-5S-K	8.38	26-3J0-00A-1B03	8.51	26-85B-000-1PP3	8.48	26-C3556-2-5T-K	8.40	26-KQB-S50-1FP3	8.48
26-1002-5T-K	8.38	26-3K0-00A-1B03	8.51	26-85B-080-1PM3	8.47	26-C40-000-1B03	8.51	26-KR0-00A-1B03	8.51
26-1002-7S-K	8.38	26-3L0-00A-1B03	8.51	26-85B-S00-1FP3	8.48	26-C50-000-1B03	8.51	26-KRB-050-1PP3	8.48
26-1002-7T-K	8.38	26-3M0-00A-1B03	8.51	26-85B-S80-1FM3	8.47	26-C60-000-1B03	8.51	26-KRB-S50-1FP3	8.48

Part Number	Page	Part Number	Page	Part Number	Page	Part Number	Page	Part Number	Page
26-MP0-00A-0F00	8.49	27-J0568-6S-K	8.50	30-0260-L96	8.52	33-0010-R8-K	8.6	34-0012-K	8.5, 8.54
27-J0413-2S-K	8.50	27-J0568-6T-K	8.50	30-0260-L96A	8.52	33-0012A-K	8.6	34-0013-K	8.21
27-J0413-2T-K	8.50	27-J0568-7S-K	8.50	30-0270-48C-K	8.52	33-0012-K	8.6	34-0019-C-K	8.4
27-J0413-3S-K	8.50	27-J0568-7T-K	8.50	30-0270-96C	8.52	33-0014A-R8-	8.6	34-0020-K	8.19
27-J0413-3T-K	8.50	27-J0568-AS-K	8.50	30-0318-48	8.52	33-0018-R6	8.6	34-0024-K	8.24
27-J0413-4S-K	8.50	27-J0568-AT-K	8.50	30-0318-96	8.52	33-0024A-K	8.6	34-0025	8.24
27-J0413-4T-K	8.50	27-J0568-XS-K	8.50	30-0324-48	8.52	33-0024B-K	8.6	34-0026-K	8.24
27-J0413-5S-K	8.50	27-J0568-XT-K	8.50	30-0324-96	8.52	33-0024C-K	8.6	34-0029	8.24
27-J0413-5T-K	8.50	27-V310-2T-K	8.42	30-0326-48	8.52	33-0024D-K	8.6	34-0030-K	8.5, 8.54
27-J0413-6S-K	8.50	27-V310-4T-K	8.42	30-0326-96	8.52	33-0024E-K	8.6	34-0033-K	8.5
27-J0413-6T-K	8.50	27-V310-5T-K	8.42	30-1001A	2.3	33-0024F-K	8.6	34-0035-K	8.5, 8.54
27-J0413-7S-K	8.50	27-V310-6T-K	8.42	30-1001E	2.3	33-0024-K	8.6	34-0036-K	8.5
27-J0413-7T-K	8.50	27-V310-7T-K	8.42	30-1002C	2.3	33-0025A-K	8.6	34-0037A-S	8.19
27-J0413-AS-K	8.50	28-E0300-2S-K	8.44	30-1011-20	8.18	33-0027-K	8.6	34-0037D-S	8.19
27-J0413-AT-K	8.50	28-E0300-4S-K	8.44	30-1011-25	8.18	33-0041A-K	8.6	34-0038A-S	8.19
27-J0413-XS-K	8.50	28-E0300-5S-K	8.44	30-1011-9	8.18	33-0041-K	8.6	34-0038D25-D	7.3
27-J0413-XT-K	8.50	28-E0300-6S-K	8.44	30-1057-36	6.1	33-51056-K	8.8	34-0038D-S	8.19
27-J0425-2S-K	8.50	28-E0300-7S-K	8.44	30-11588-100	8.18	33-51230-K	8.8	34-0039A-S	8.19
27-J0425-2T-K	8.50	30-0015G-K	8.43	30-11588-25	8.18	33-52213-K	8.8	34-0039D-S	8.19
27-J0425-3S-K	8.50	30-0015J-K	8.43	30-11588-50	8.18	33-52295-K	8.8	34-0040	8.24
27-J0425-3T-K	8.50	30-0016A-K	8.52	30-11589-100	8.18	33-52320-K	8.8	34-0049-K	8.5
27-J0425-4S-K	8.50	30-0016-K	8.52	30-11589-25	8.18	33-52532-K	8.8	34-0052A-K	8.5
27-J0425-4T-K	8.50	30-0018	2.3	30-11589-50	8.18	33-53426-K	8.8	34-0058-K	8.5
27-J0425-5S-K	8.50	30-0024	2.3	30-1180-L48	8.52	33-53544-K	8.8	34-0059-K	8.19
27-J0425-5T-K	8.50	30-0061B-K	8.21	30-1180-L6	8.52	33-53681-K	8.8	34-0069C-K	8.4
27-J0425-6S-K	8.50	30-0061C-K	8.21	30-1180-L96	8.52	33-53834-K	8.7	34-0073-K	8.24
27-J0425-6T-K	8.50	30-0061D-K	8.21	30-1200-A48	6.1	33-54091-K	8.8	34-0081B-K	8.5
27-J0425-7S-K	8.50	30-0062-K	8.21	30-1200-L48	8.52	33-54115-K	8.7	34-0081C-K	8.5
27-J0425-7T-K	8.50	30-0100A-30-K	8.52	30-1200-L6	8.52	33-54122-K	8.8	34-0081-K	8.5
27-J0425-AS-K	8.50	30-0100A-60-K	8.52	30-1200-L96-K	8.52	33-54161-K	8.8	34-0084-K	8.21
27-J0425-AT-K	8.50	30-0130-60-K	8.42	30-1210-L48	8.52	33-54357-K	8.7	34-01395-K	8.21
27-J0425-XS-K	8.50	30-0131-60-K	8.42	30-1210-L6	8.52	33-54369-K	8.7	34-01395-K	8.39
27-J0425-XT-K	8.50	30-0132-60-K	8.42	30-1210-L96	8.52	33-54372-K	8.7	34-0148A-K	8.4
27-J0519-2S-K	8.50	30-0133-60-K	8.42	30-1220A-L48	8.52	33-54383-K	8.7	34-0153-K	8.4, 8.43
27-J0519-2T-K	8.50	30-01395-K	8.22	30-1220-L48	8.52	33-54385-K	8.7	34-0154	8.19
27-J0519-3S-K	8.50	30-0180-48-K	8.52	30-1220-L6	8.52	33-54446-K	8.8	34-0155-K	8.54
27-J0519-3T-K	8.50	30-0180-96	8.52	30-1220-L96	8.52	33-54646-K	8.7	34-0178A-K	8.4, 8.43
27-J0519-4S-K	8.50	30-0190-30	8.52	30-1230-L48	8.52	33-55137-K	8.8	34-0178B-K	8.4
27-J0519-4T-K	8.50	30-0190-48	8.52	30-1230-L6	8.52	33-55151-K	8.7	34-0178-K	8.4, 8.54
27-J0519-5S-K	8.50	30-0190-60VH	8.52	30-1230-L96	8.52	33-55152-K	8.7	34-0189-K	8.9
27-J0519-5T-K	8.50	30-0190-96	8.52	30-1240-L48	8.52	33-55299-K	8.7	34-0190A-K	8.9
27-J0519-6S-K	8.50	30-0200-48-K	8.52	30-1240-L6	8.52	33-55602-K	8.7	34-0190A-UB	8.9
27-J0519-6T-K	8.50	30-0200-96	8.52	30-1240-L96	8.52	33-55840-K	8.7	34-0190-K	8.9
27-J0519-7S-K	8.50	30-0210-48-S	8.52	30-1260-L48	8.52	33-56297-K	8.7	34-0193-K	8.9
27-J0519-7T-K	8.50	30-0210-96-K	8.52	30-1270-C6	8.52	33-56299-K	8.7	34-0196A-K	8.9
27-J0519-AS-K	8.50	30-0220-48-K	8.52	30-1302-48	6.1	33-56380A-K	8.7	34-0197-25-K	8.9
27-J0519-AT-K	8.50	30-0220-96-K	8.52	30-1302-96	6.1	33-56380B-K	8.7	34-0197-K	8.9
27-J0519-XS-K	8.50	30-0230-48-K	8.52	30-1302A-48	6.1	33-56380-K	8.7	34-0197-UB	8.9
27-J0519-XT-K	8.50	30-0230-96-K	8.52	30-1302A-96	6.1	33-56483-K	8.7	34-0198A-K	8.9
27-J0568-2S-K	8.50	30-0240-48-K	8.52	30-22630-100	8.18	33-56488-K	8.7	34-0198-K	8.9
27-J0568-2T-K	8.50	30-0240-96-K	8.52	30-22632-50	8.18	33-56585-K	8.7	34-0198-UB	8.9
27-J0568-3S-K	8.50	30-0250-48C-K	8.52	30-22635-25	8.18	33-56961-K	8.7	34-0199F-K	8.4
27-J0568-3T-K	8.50	30-0250-96C	8.52	30-25657	8.18	33-56965-K	8.7	34-0200-K	8.9
27-J0568-4S-K	8.50	30-0260-48	8.52	30-25662-100	8.18	34-0002-K	8.19, 8.54	34-0201B-K	8.20
27-J0568-4T-K	8.50	30-0260-96	8.52	30-25662-25	8.18	34-0007	8.21	34-0201D-36-K	8.20
27-J0568-5S-K	8.50	30-0260-L48	8.52	30-25662-50	8.18	34-0010-K	8.5	34-0201D-72-K	8.20
27-J0568-5T-K	8.50	30-0260-L48UST	8.52	33-0010-R1-5	8.6	34-0012A-K	8.5	34-0201D-K	8.20

Part Number	Page	Part Number	Page	Part Number	Page	Part Number	Page
34-0201-K	8.20	34-50403-K	8.14	34-54548-K	8.12	35-0047-K	8.24
34-0202B-K	8.20	34-51057-K	8.12	34-54589-K	8.13	35-0058-K	8.24
34-0202C-K	8.20	34-51159-K	8.18	34-54652-K	8.13	35-0059	8.24
34-0203A-S-K	8.20	34-51223-K	8.12	34-54664-K	8.12	35-0060-K	8.24
34-0203D-18-K	8.20	34-51225-K	8.12	34-54665-K	8.11	35-0061	8.24
34-0203D-36-K	8.20	34-51247-K	8.12	34-54681-K	8.12	35-0062-K	8.24
34-0203D-72-K	8.20	34-51248-K	8.12	34-54685-K	8.11	35-0063-K	8.24
34-0203D-K	8.20	34-51452-K	8.12	34-54716-K	8.12	35-0064-K	8.24
34-0203-K	8.20	34-51574-K	8.14	34-54726-K	8.13	35-0066-K	8.24
34-0203Y-36-K	8.20	34-51676-K	8.12	34-54873-K	8.23	35-0067-K	8.24
34-0203Y-72-K	8.20	34-51705-K	8.14	34-55049-K	8.11	35-0074A-K	8.24
34-0203Y-K	8.20	34-52144-K	8.11	34-55050-K	8.11	35-0074B	8.24
34-0203Y-STD-K	8.20	34-52274-K	8.14	34-55051-K	8.11	35-0074-K	8.24
34-0203Y-VH2-K	8.20	34-52312-K	8.11	34-55080-K	8.11	35-0078-K	8.1
34-0207-25-K	8.9	34-52345-K	8.12	34-55081-K	8.11	35-0079-K	8.24
34-0207-K	8.9	34-52487-K	8.11	34-55123-K	8.11	35-0080	8.24
34-0208-25-K	8.9	34-52649-K	8.13	34-55129-K	8.11	35-0081-K	8.24, 8.54
34-0208-K	8.9	34-52654-K	8.13	34-55304-K	8.13	35-21581-K	8.24
34-0209-0-K	8.9	34-52678-K	8.14	34-55349-K	8.12	36-0004A-K	8.19, 8.54
34-0216G-K	8.18	34-52682-K	8.14	34-55350-K	8.12	36-0006	8.19
34-0217-K	8.4	34-52683-K	8.14	34-55390-K	8.12	36-0006A	8.54
34-0221A-K	8.4	34-52684-K	8.13	34-55431-K	8.11	37-0001-K	8.19
34-0221B-K	8.4	34-52685-K	8.13	34-55456-K	8.11	37-0002-K	8.21
34-0221-K	8.4, 8.43	34-52746-K	8.14	34-55487-K	8.14	37-0005-K	8.21
34-0236A-K	8.9	34-52747-K	8.14	34-55532-K	8.14	37-0014-K	8.19
34-0236-K	8.9	34-53189-K	8.12	34-55533-K	8.14	37-0029-SM	8.19
34-0237-K	8.9	34-53238-K	8.11	34-55536-K	8.13	37-0031-SM	8.19
34-0239-K	8.9	34-53272-K	8.12	34-55559-K	8.11	37-0051A	8.21
34-0240A-K	8.9	34-53334-K	8.14	34-55563-K	8.11	37-0051-K	8.21
34-0240-K	8.9	34-53392-K	8.13	34-55570-K	8.12	37-0052A-K	8.21
34-0241A-K	8.9	34-53469	8.18	34-55580-K	8.13	37-0053B-K	8.21
34-0241-K	8.9	34-53502-K	8.13	34-55600-K	8.13	37-0053-K	8.21
34-0242A-K	8.9	34-53565-K	8.11	34-55609-K	8.13	39-0010-B-K	8.43
34-0242-K	8.9	34-53566-K	8.11	34-55673-K	8.13	39-0010-UR7-K	8.43
34-0243-K	8.9	34-53567-K	8.13	34-55936-K	8.14	39-0010-UR8-K	8.43
34-0244-K	8.9	34-53605-HQ-K	8.20	34-55989-K	8.13	39-0010-UR9-K	8.43
34-0250-K	8.9	34-53605-K	8.20	35-0002-K	8.1	39-0015-S	8.52
34-0381-K	8.23	34-53643-K	8.11	35-0003-K	8.1, 8.54	39-0021-K	8.20
34-0382	8.23	34-53645-K	8.11	35-0012-K	8.1, 8.54	39-0035	8.52
34-30337-HQ-K	8.20	34-53777-K	8.11	35-0014-K	8.1, 8.54	39-0036	8.52
34-30337-K	8.20	34-53811-K	8.12	35-0019-K	8.24, 8.54	40-0008-K	8.26, 8.55
34-30379	8.4	34-54093-K	8.12	35-0020	8.24	40-0009-K	8.26, 8.55
34-30674-K	8.20	34-54094-K	8.11	35-0020A	8.24	40-0010-K	8.26, 8.55
34-32016-HQ-K	8.20	34-54100-K	8.12	35-0021	8.24	41-0010	8.22
34-32016-K	8.20	34-54104-K	8.12	35-0022	8.24	42-0001-K	8.25
34-50055-K	8.12	34-54105-K	8.12	35-0024	8.24	42-0002A-K	8.26
34-50056-K	8.13	34-54107-K	8.12	35-0025-K	8.1	42-0002-K	8.26
34-50175-K	8.11	34-54108-K	8.13	35-0026-K	8.1	42-0002-T-K	8.26
34-50176-K	8.11	34-54128-K	8.13	35-0027-K	8.24	42-0003A-K	8.26
34-50217-K	8.12	34-54135-K	8.11	35-0028-K	8.1, 8.54	42-0003-K	8.26
34-50259-K	8.13	34-54142-K	8.13	35-0031A	8.1	42-0004A-K	8.53
34-50260-K	8.13	34-54170-K	8.12	35-0031-K	8.1	42-0004-K	8.27, 8.53
34-50261-K	8.13	34-54251-K	8.11	35-0032-K	8.24	42-0005-K	8.26, 8.53
34-50262-K	8.13	34-54268-K	8.11	35-0035	8.24	42-0006A-K	8.25
34-50335-K	8.13	34-54451	8.23	35-0036-K	8.1	42-0006-T-K	8.25
34-50390-K	8.14	34-54528-K	8.13	35-0037-K	8.1, 8.54	42-0007B-K	8.54
34-50401-K	8.14	34-54547-K	8.12	35-0047A-K	8.24	42-0009-K	8.26

Part Number	Page	Part Number	Page	Part Number	Page	Part Number	Page	Part Number	Page
42-0011A-K	8.26	42-30-3807	8.27	48-0148-K	7.3	51-56016-Z	2.3	80-0511D-K	8.18
42-0011-K	8.26	42-30-6103	8.27	48-0152A-S	8.54	51-56377-Z	2.3	80-10165	2.3
42-0012-K	8.26	42-30-6104	8.27	48-0152-S	8.54	51-56480-Z	2.3	80-10307-K	8.15
42-0013-K	8.4, 8.26	42-4HP102X	8.27	48-0154	8.22, 8.54	51-56485-Z	2.3	80-10328-K	8.16
42-0015A-K	8.25	42-50-221XBRN	8.27	48-0197A	8.18	51-56582-Z	2.3	80-10352-K	8.15
42-0015C-K	8.25	42-LED-10S	8.19	48-0197D	8.18	60-0001	8.50	80-10402-K	8.16
42-0015D-K	8.25	48-0001B	8.53	48-0201	8.39	60-0001-K	8.27	80-10418-K	8.15
42-0015-K	8.25	48-0002	8.20	48-0202-K	8.32-8.33	60-0005	8.31	80-10429-K	8.16
42-0016-K	8.25	48-0007A	8.50	48-0210-S	8.9	60-0008	8.22	80-10430-K	8.16
42-0017A-K	8.25	48-0007B	8.50	48-0223A	8.4	60-0010A-K	8.33	80-10559-K	8.17
42-0017-K	8.25, 8.53	48-0010C	8.53	48-0223B-K	8.4	60-0010B-K	8.34	80-10668-K	8.15
42-0018-K	8.25	48-0013	8.5	48-0223C	8.4	60-0010C	8.31-8.34	80-10669-K	8.15
42-0022B-K	8.27	48-0014	8.50	48-0300-K	8.43	60-0010-K	8.31, 8.32	80-10671-K	8.15
42-0022-K	8.25	48-0017	8.50	48-0301-K	8.43	60-0011	8.31-8.34	80-10694-K	8.17
42-0023-K	8.25	48-0017A	8.50	48-0303-K	8.43	60-0011A	8.33	80-10721-K	8.15
42-0024A-K	8.26	48-0018	8.50	48-0304-K	8.43	60-0015-K	8.27, 8.53	80-10752-K	8.15
42-0031-A-K	8.25	48-0018A	8.50	48-0305-K	8.43	60-0017-K	8.27, 8.53	80-10753-K	8.15
42-0031F-A-K	8.25	48-0019	8.50	48-260032-R1	8.47	60-0020-K	8.27, 8.53	80-10763-K	8.16
42-0031F-K	8.25	48-0019A	8.50	48-260034-R1	8.47	60-0022-K	8.22	80-10764-K	8.15
42-0031-K	8.25	48-0021	8.22	48-260036-R1	8.47	60-0028-K	8.21	80-10823-K	8.16
42-0037-K	8.26	48-0023	8.23	48-9120-7P-K	8.35	61-0011A-K	6.2	80-10839-K	8.15
42-0047-K	8.27	48-0023A	8.23	48-9121-7S-K	8.35	64-0001B	8.19, 8.54	80-10841-K	8.16
42-0047-T-K	8.27	48-0023B	8.23	48-9122-AT-K	8.35	64-0012	8.19, 8.55	80-11095-K	8.15
42-0049-K	8.26	48-0023C	8.23	48-9123-7T-K	8.35	64-0017	8.55	80-11109	2.3
42-0056-K	8.26	48-0023XL	8.23	48-9124-AP-K	8.35	65-0119A	8.50	80-11127-K	8.15
42-0068-K	8.26	48-0029A	8.53	48-9125-5T-K	8.35	80-0132D-BES	8.55	80-11159-K	8.16
42-0070A-K	8.29	48-0041A-K	8.22	48-9130-CP-K	8.35	80-0201-K	8.10	80-11219-K	8.15
42-0070-K	8.29	48-0041A-K	8.39	48-9150-5P-K	8.35	80-0202-K	8.10	80-11281-K	8.17
42-0073-K	8.26	48-0041B-K	8.22	48-9151-AP-K	8.35	80-0203-K	8.10	80-11344-K	8.16
42-0074A-K	8.27, 8.53	48-0041B-K	8.39	48-P250-PBES-LO	8.53	80-0204-K	8.10	80-11345-K	8.16
42-0074-K	8.27, 8.53	48-0041-K	8.22	48-P250-PBES-UP	8.53	80-0205-K	8.10	80-11393-K	8.16
42-0078-K	8.26	48-0041-K	8.39	49-0420A-K	7.3	80-0207-K	8.10	80-11428-K	8.17
42-0085-K	8.26	48-0042-K	7.3	49-0420A-K	8.27	80-0208-K	8.10	80-11448-K	8.15
42-0086-K	8.26	48-0057	8.50	49-0421-K	7.3	80-0209-1-K	8.10	80-11476-K	8.17
42-0087-K	8.26	48-0067-K	8.29	49-0421-K	8.27	80-0211-10-K	8.10	80-11520-K	8.15
42-0088-K	8.27	48-0072A-K	8.26, 8.53	49-0422-K	8.27	80-0211-K	8.10	80-11521-K	8.15
42-0116-K	8.27	48-0072B-K	8.53	50-54216-Z	2.1	80-0222-1-K	8.10	80-11609-K	8.16
42-0117-K	8.27	48-0072C-K	8.53	50-54217-Z	2.1	80-0222-2-K	8.10	80-11671-K	8.15
42-10-5300BRN	8.27	48-0072-K	8.26, 8.53	50-54218-Z	2.1	80-0230-A-K	8.10	80-11688-K	8.16
42-10-5470BRN	8.27	48-0074-K	8.27	50-54219-Z	2.1	80-0236A-K	8.10	80-11718	2.3
42-10-5671BRN	8.27	48-0082-K	8.27	50-54220-Z	2.1	80-0236-K	8.10	80-11724-K	8.15
42-10-6530BRN	8.27	48-0088	8.53	50-54829-Z	2.2	80-0237-K	8.10	80-11725-K	8.15
42-2333B-K	8.54	48-0088A	8.53	50-54830-Z	2.2	80-0239-K	8.10	80-11745-K	8.15
42-2334A-K	8.27	48-0092S	8.5	50-54831-Z	2.2	80-0240A-K	8.10	80-11746-K	8.15
42-2334B-K	8.27	48-0095-K	8.27	50-54832-Z	2.2	80-0240-K	8.10	80-11756-K	8.16
42-2334-K	8.27	48-0096-K	8.27	50-54833-Z	2.2	80-0241A-K	8.10	80-11762-K	8.17
42-2360B-K	8.43	48-0099X-120	8.21	50-54834-Z	2.2	80-0241-K	8.10	80-11764-K	8.15
42-2370-K	8.43	48-0099X-240	8.21	50-54835-Z	2.2	80-0242A-K	8.10	80-11765-K	8.15
42-2373-K	8.25	48-0101	8.6	50-54836-K	2.2	80-0242-K	8.10	80-11773-K	8.16
42-2380-K	8.25	48-0120	8.4	50-54837-Z	2.2	80-0243-K	8.10	80-11774-K	8.16
42-2384-K	8.25	48-0120B	8.4	50-54838-Z	2.2	80-0250-K	8.10	80-11789-K	8.16
42-2386-K	8.25	48-0140F-K	7.3	51-54356-Z	2.3	80-0499	8.19	80-11790-K	8.16
42-2387-K	8.25	48-0140P-K	7.3	51-54368-Z	2.3	80-0510A-K	8.18	80-11806-K	8.17
42-2390-K	8.25	48-0141C-K	7.3	51-54371-Z	2.3	80-0510B-K	8.18	80-11822-K	8.15
42-2391-K	8.25	48-0141-K	7.3	51-54377-Z	2.3	80-0510C-K	8.18	80-11823-K	8.17
42-2392-K	8.25	48-0143-K	7.3	51-54805-Z	2.3	80-0511A-K	8.18	80-11852-K	8.15
42-30-3803BRN	8.27	48-0146-K	8.53	51-56007-Z	2.3	80-0511B-K	8.18	80-11853-K	8.17

**Part Number**      **Page**

80-11877-K	8.16
80-11884-K	8.15
80-11885-K	8.15
80-11892-K	8.16
80-11894-K	8.16
80-11899-K	8.16
80-11901-K	8.16
80-11907-K	8.17
80-11908-K	8.17
80-11909-K	8.16
80-11946-K	8.15
80-11947-K	8.16
80-11957-K	8.16
80-11984-K	8.16
80-12037-K	8.17
80-12050-K	8.15
80-12051-K	8.16
80-12052-K	8.17
80-12053-K	8.17
80-12101-K	8.17
80-12122-K	8.17
80-12132-K	8.17
80-12183-K	8.16
80-12198-K	8.17
80-12237-K	8.15
80-12238-K	8.15
80-12437-K	8.16
80-12438-K	8.16
80-12510-K	8.17
80-12511-K	8.17
80-12512-K	8.17
80-12513-K	8.17
80-12762-K	8.17
80-12966-K	8.17
80-12974-K	8.17
80-12975-K	8.17
80-40026-K	8.17
80-40030-K	8.17
80-40096-K	8.17
80-40097-K	8.17
80-40098-K	8.17
80-40105-K	8.17
993-0262-A48-S	8.55
993-0262A-A48-S	8.55
993-0262A-L48-S	8.29
993-0262A-L48-S	8.55
993-0262-L-48-S	8.55
993-0265-A48-S	8.55
993-0265A-A48-S	8.55
993-0265A-L48-S	8.55
993-0265-L48-S	8.55
993-0380-A6-S	8.29
993-0380-A6-S	8.55
993-0380A-A6-S	8.29
993-0380A-A6-S	8.55

# Why choose Hydro-Quip? Here's why ...

## Warranty & Customer Service

At Hydro-Quip, our most vital asset is our customers. We strive to ensure that the needs of our customers are being met. Not only do we have a knowledgeable technical staff, we also offer warranty on all our products

## Wide Selection of Heater Assemblies

Our HQ generic heater series offers replacements for Therm Products, Balboa, Gecko and many more. We also produce the Universal Rite-Fit heater series that will replace 100's of different heater assemblies in the field.

## Replacement Parts

Many of the parts in this catalog are most likely familiar although you may not have had a good dependable source to purchase them from until now. Whether you are looking for electro-mechanical or solid state replacement parts, you will find many of top sellers in this catalog.

## Balboa® Retrofit Kits

Hydro-Quip is now offering Balboa Retrofit Kits which includes VS and BP Series Systems. With our extensive list of Balboa replacement parts it makes us a dependable source for Balboa replacement products.

## Retro-Fit Slide Controls

Hydro-Quip Continues to offer the broadest selection of retro-fit controls and equipment to fit all of your spa or hot tub needs. The "Slide" heater feature allows for a flexible fit heater to get your job completed in a quick and efficient manner.

## UL Listed Outdoor Equipment System

Our UL Listed Equipment Systems are available as 5.5 or 11KW electric and gas ready are now WiFi capable. This system is perfect for customers who are operating their spa independently, our 8000 series brings all the features necessary for a stand alone state of the art hot tub or spa installation.

## Integrated Ozone Generator

By integrating the Ozone Generator into our Spa products we now have the Ozonator interlocked to operate automatically when the power is on. An integrated Ozone generator also eliminates an "extra" component (or two) to be mounted under the spa.

## Global Connectivity

Hydro-Quip is now offering a new line of Wi-Fi Enabled Systems. This feature gives you the capability of running your spa or hot tub using a smartphone or tablet.

THE DISTRIBUTOR'S CHOICE IN THE LEISURE WATER INDUSTRY.

copyright 2019 HydroQuip 12/10/19



510A N. Sheridan St.  
Corona, CA 92880  
Tel: 951.273.7575  
HydroQuip.com