

6" ROUND HOCKEY PUCK SUMPLESS SUCTION OUTLET COVER, HYDROAIR/ITT REPLACEMENT



**VGB CERTIFIED
SPECIFICATIONS**

Floor Flow Rating

2" pipe: 160 GPM at 4.9 fps
1½" pipe: 144 GPM at 4.4 fps

Wall Flow Rating

2" pipe: 92 GPM at 2.8 fps
1½" pipe: 92 GPM at 2.8 fps

Sump Depth

Sumpless

Open Area

10.4 in²

FEATURES

All components meet or exceed ANSI/APSP 16-2011 and NSF/ANSI 50-2009a national standards and ASTM G154 UV testing exposure

See next page for eight adapter plates sold separately, available for sumpless connections to 1022s, 1½" female adapters, 1½" and 2" inside and outside slip and threads

Easily and safely retrofits many HydroAir/ITT parts

Manufactured from superior UV-resistant engineered polymers

#316 stainless steel screws

Trademarked VGB compliance button easily identifies VGB 2008 compliant cover from on deck and underwater

Online product support including downloadable CAD files, General Certificate of Conformity, third-party certificate, installation instructions and more

Replace drain cover every five years from the date of installation

25 per case

No sump required!



Part # 6HPHAxxx

For fiberglass option, see page 136

STANDARD COLORS

- 6HPHA101 – White
- 6HPHA102 – Black
- 6HPHA103 – Light Gray
- 6HPHA104 – Blue
- 6HPHA105 – Dark Gray
- 6HPHA108 – Tan

Replaces p/n 6HPxxx

VGB 2008 Compliant

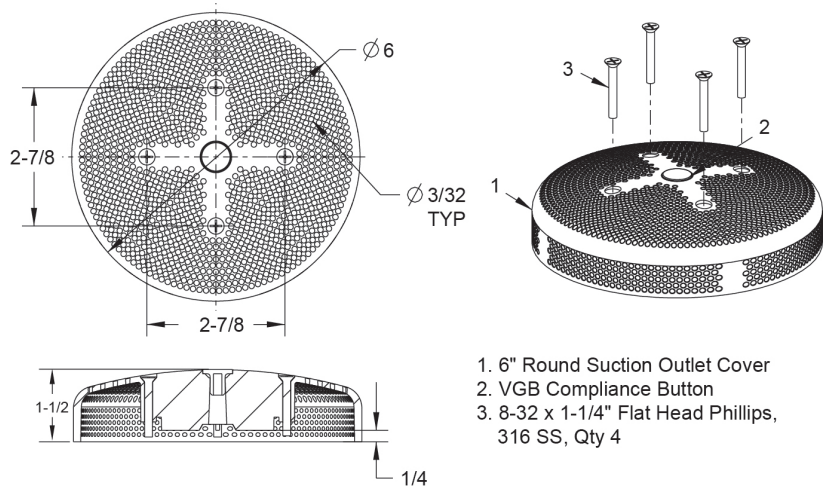

1. 6" Round Suction Outlet Cover
2. VGB Compliance Button
3. 8-32 x 1-1/4" Flat Head Phillips, 316 SS, Qty 4

Retrofits to Sta-Rite/Pentair #8011 and AquaStar #4RNDxxx equalizer

P 877-768-2717 F 877-276-POOL Outside the US: P +1-949-336-1940 F +1-949-336-1940

info@aquastarpoolproducts.com www.aquastarpoolproducts.com

ADDITIONAL PRODUCT CONFIGURATIONS FOR 6HPHxxx (sold separately) 25/case

STANDARD COLORS 101 102 103 104 105 108

Code Key: xxx = Color 15 = 1½", 20 = 2" SI = Slip Insider
 (i.e. 101 = White) 25 = 2½" T = Thread

6" Bulkhead Adapter with 2½" Thread and 2" Socket for Fiberglass/Steel, with Gasket and 2½" Locking Nut



Part #
6HA25T20Sxxx

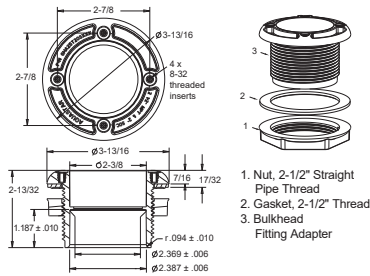

6" Bulkhead Adapter with 2" Socket Sumpless Fitting



Part #
RNDxxx

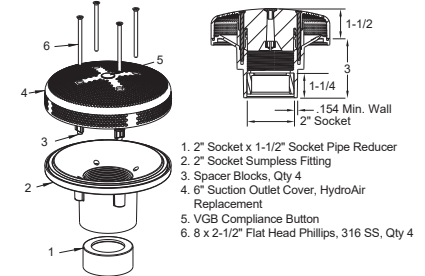

6" Bulkhead Adapter with 1½" Threaded Sumpless Fitting

Fits 1022 female adapters



Part #
615Txxx

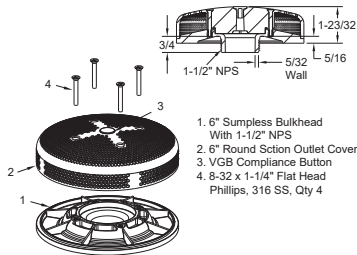

6" Bulkhead Adapter with Extended 1½" Threaded Sumpless Fitting

Use with flush mount 1½" FPT, does not fit 1022 female adapters



Part #
6E15Txxx

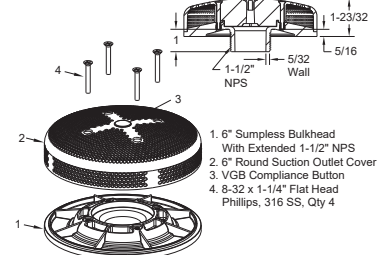

6" Bulkhead Adapter with 1½" Slip-Insider Sumpless Fitting



Part #
615SIxxx

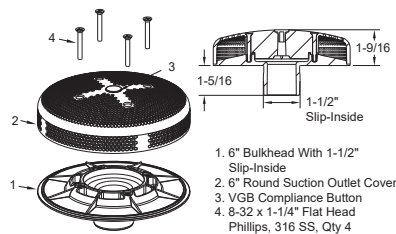

6" Bulkhead Adapter with 2" Threaded Sumpless Fitting

Also available as 1½" slip Insider p/n 615SIxxx



Part #
620SIxxx

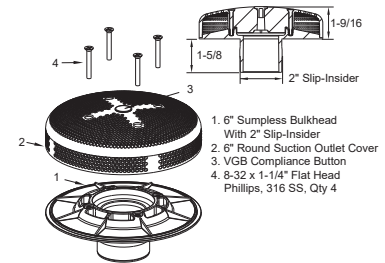

6" Bulkhead Adapter with 2" Threaded x 1½" Socket Sumpless Fitting



Part #
620T15Sxxx

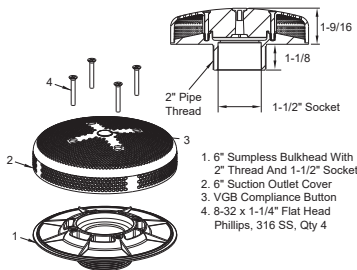

6" Bulkhead Adapter with 2½" Threaded x 2" Socket Sumpless Fitting



Part #
625T20Sxxx

