

MDX-R3 FOR ADJUSTABLE CONCRETE POOLS OWNER'S MANUAL AND INSTALLATION GUIDE

SUBMERGED SUCTION OUTLET
FOR MULTIPLE DRAIN USE FOR USE ON FLOOR

SEE SPECIAL INSTRUCTIONS FOR CALIFORNIA ON PAGE 7



Safety compliant according to the Virginia Graeme Baker Pool and Spa Safety
Act ANSI/APSP - 16 - 2011
Compliant with ANSI/APSP - 7 - 2006.

NOTICE

To Installers: Read and follow these instructions. Give these instructions to the facility owner to keep for future reference. Follow all codes and regulations that apply to the design, installation and use of suction outlet fittings.



WARNING

MDX-R3 and SDX must be installed in accordance with Paramount's written instruction manual, and in conformity with applicable Federal, State, Local and Swimming pool industry building and safety codes.



Paramount

Pool Life. Simplified.

295 East Corporate Place • Suite 100 • Chandler, AZ 85225

Toll Free: 1.800.621.5886 • Phone: 480.893.7607 • Fax: 480.753.3397

Paramount@1Paramount.com • www.1Paramount.com

US and Foreign patents and patents pending see www.1paramount.com/about/patents/

Signal Words and Symbols Used In This Manual

This Owner's Manual and Installation Guide contains specific precautions and symbols to identify safety-related information. You will find DANGER, CAUTION, WARNING and NOTICE symbols which require special attention. Please read them carefully and follow these precautions as indicated! They will explain how to avoid hazards that may endanger you or persons using or maintaining your pool or spa.



DANGER

DANGER indicates a hazardous situation which, if not avoided, will result in death or serious injury.



WARNING

WARNING indicates a hazardous situation which, if not avoided, could result in death or serious injury.



CAUTION

CAUTION indicates a hazardous situation which, if not avoided, could result in minor or moderate injury.

NOTICE

NOTICE is used to address practices not related to physical injury.

PLEASE REVIEW THE OWNER'S MANUAL AND INSTALLATION GUIDE IN ITS ENTIRETY AND HEED ALL SAFETY INFORMATION. Failure to follow these instructions and warnings can result in DEATH OR SERIOUS INJURY.

SUCTION ENTRAPMENT HAZARD:



DANGER

DEATH or SERIOUS INJURY will result if a drain cover or grate is not installed and used correctly.

- Pool and spa pumps produce high levels of suction and move high volumes of water, which can cause death or serious injury if a person comes in close proximity to pool or spa drains.
- Keep clear of pool and spa drains to avoid death or serious injury from suction.



DANGER

DEATH or SERIOUS INJURY will result from hair entanglement or limb entrapment.



- Keep clear of pool and spa drains.
- Hair sucked into pool or spa drains will tangle and knot trapping the swimmer underwater. Avoid placing your hair near a pool or spa drain.
- Avoid sitting on pool or spa drains because the suction can cause severe intestinal damage, evisceration, and/or disembowelment.



DANGER

DEATH or SERIOUS INJURY will result from pool or spa drain covers or grates that are improperly installed, missing, clogged, or broken.

- Inspect pool and spa regularly to insure that drain covers and grates are properly in place and secured.
- Ensure that drain covers are not damaged, cracked, broken, loose, clogged, not properly secured, or missing because these conditions increase the chance of death or serious injury from entrapment.
- If a drain cover is discovered damaged, cracked, broken, loose, clogged, not properly secured, or missing, you should:
 - Close the pool or spa immediately; and,
 - Post a closure notice and keep the pool or spa closed until an appropriate ANSI/APSP -16-2011 certified drain cover is properly installed.

DANGER

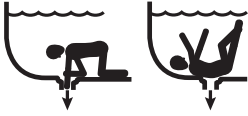

DEATH or SERIOUS INJURY will result from contact with a damaged, loose, or missing drain cover.

- Do not allow limbs to contact or be inserted into a drain pipe with a damaged, loose, or missing drain cover. This could result in swelling of the limb and/or trapping a swimmer underwater.
- Avoid mechanical entrapment of jewelry, swimsuit, hair decorations, finger, toe, or knuckle in a drain pipe with damaged, loose, or missing drain cover. This may result in trapping a swimmer underwater.
- Do not allow body to come into contact with a drain pipe that has a damaged, loose, or missing drain cover. This may result in trapping a swimmer underwater.

MAINTENANCE INSTRUCTIONS & WARNINGS:

WARNING

DEATH or SERIOUS INJURY can result from pool or spa drain covers or grates that are clogged by debris.

- All pool and spa drain covers may become obstructed by debris and should be cleaned periodically due to clogging from debris, such as pieces of plastic, hair, fabric, twigs, leaves, seeds, etc.
- The frequency of periodic cleaning will vary depending on the amount and type of debris introduced into the pool or spa
- Clogging of the drain cover will increase the suction effect and increase the likelihood of death or serious injury from those hazards listed above.
- A clogged drain can negatively affect the safety of the drain.
- It is advisable to have a qualified pool or spa professional perform this inspection and debris removal from the pool or spa drain covers.

Suction can pose a serious hazard to swimmers just as electricity can be a hazard. Both are important for proper water filtration and both must be treated with respect. Suction safety begins with a professional design that includes a quality suction system installed by a certified contractor.

The MDX-R3 VGB Compliant Debris Drain is only available to certified contractors for the same reason certified electricians are required to connect filtration pumps to public utilities; both require proper training and certification to assure no hidden hazards are built into the project.

Certified builders will address the following issues when designing and installing a proper filtration system:

- Properly bond-grounded pumps, time clocks, switches and any other metal in or near water. This is required to address Electrical Shock Hazards.
- Design the suction piping so there are no single-point suction hazards; single-point suction (one drain) is a leading cause of Body Suction Entrapment Hazards. Note: your certified builder has many effective options for addressing this hazard; they may include dual-drain systems, like MDX-R3, skimmers, gutters, negative edge features and many more products and piping designs known to professionals.
- Install ANSI/APSP - 16 - 2011 listed drains, suction covers and debris removal systems. This is the ONLY approved option for preventing Hair Entrapment Hazards, the leading cause of suction related injuries.
- Design and install an effective circulation system (including optional cleaning systems), to direct filtered water to all areas and interior surfaces. NOTE: Suction fittings can NOT clean or direct filtered water for proper sanitation; that can only be done on the pressure (return) side of the filtration system.

While suction injuries are extremely rare, drowning and diving injuries are far too common and there is little your certified builder can do to eliminate these hazards. You must educate yourself and your guests. Below are some important safety issues every swimmer must know and recognize.

- **PREVENT DROWNING:** Watch children at all times, no swimming alone.
- **NO DIVING IN SHALLOW WATER:** You can be permanently injured.
- **PREVENT SUCTION ENTRAPMENT:** Inspect suction covers before swimming, keep swimmers away from suction fittings, protect long hair, don't swim with loose clothing or large and dangling jewelry.

MDX-R3 SYSTEM DESIGN



WARNING

MDX-R3 and SDX must be installed in accordance with Paramount's written instruction manual, and in conformity with applicable Federal, State, Local and Swimming pool industry building and safety codes.

These MDX-R3 instructions provide two methods to choose from, with additional methods for specific jurisdictions, (California specifically but not limited to that state). Your local codes may require additional safety measures. Paramount Pool & Spa Systems and its representatives cannot recommend or endorse installation methods other than those provided in these MDX-R3 instructions.

NOTICE

Maximum Pump Size:

MDX-R3 is rated for a maximum of 132 GPM (500 LPM). While system flow rate will vary with pump size and the Total Head Loss for a given system, virtually any modern pump is capable of exceeding this limit, therefore it is the responsibility of the system designer to make sure it is not possible to exceed 132 GPM (500 LPM).

In the event of one suction outlet being completely blocked, the remaining suction outlets serving that system shall have a flow rating capable of the full flow of the pump(s) for the specific suction system.

NOTICE

The use of two 45° in place of a 90° allows for the best debris removal and minimizes large debris from getting caught in the line.

NOTICE

Plumbing of the included enlarged suction element (13" of 4" pipe) to the 4" port of the MDX-R3 is required. After the enlarged suction element, the included reducer adaptor may then be used to reduce the pipe size to 2½". A 3" coupler may be attached to the outside diameter of the reducer or a 4" coupler directly to the enlarged suction element for systems where the flow through the MDX-R3 is intended to exceed 90 GPM. **Use of 2½" pipe minimum throughout the suction side of the system is strongly encouraged for optimum performance.** For your convenience, Paramount Pool & Spa Systems includes the enlarged suction element, and the reducer adaptor with the MDX-R3. To order separately, please see page 12 for the part number.

MDX-R3 VGB COMPLIANT DEBRIS DRAIN
STANDARD POOL DESIGN
DUAL DRAIN

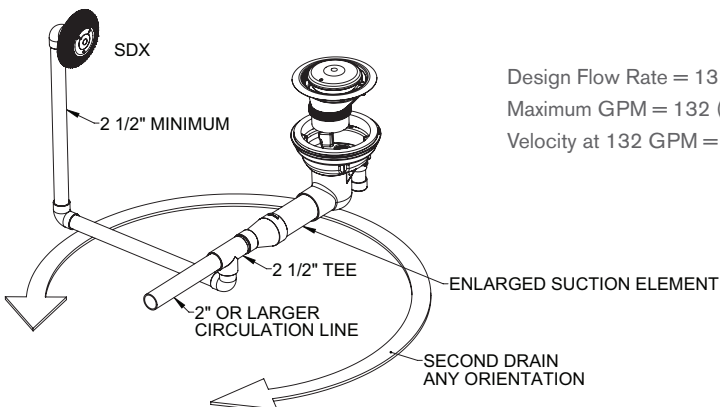

Design Flow Rate = 132 GPM (500 LPM)
Maximum GPM = 132 (500 LPM)
Velocity at 132 GPM = 1.294 FPS (.39 MPS)

FLOW HEAD LOSS CURVE

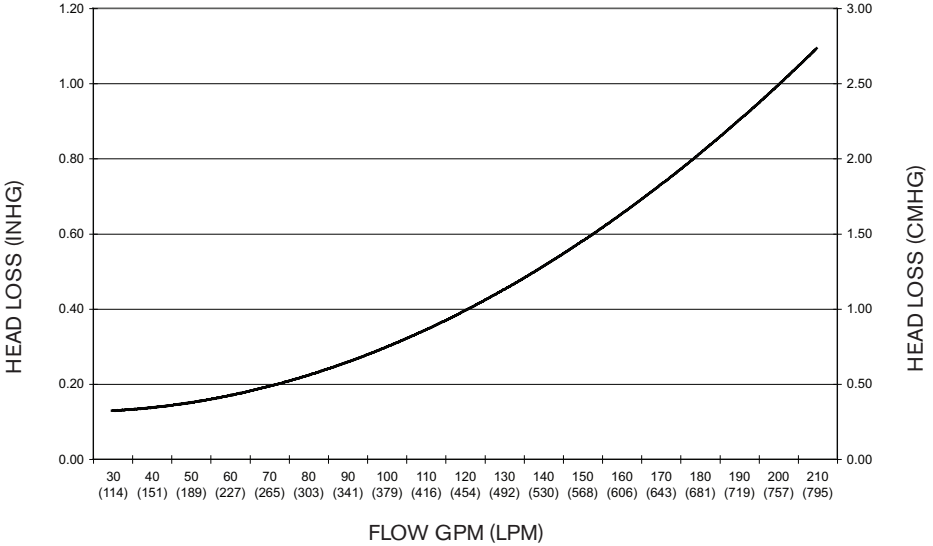

MDX-R3 INSTALLATION METHOD 1

WITH CANISTER

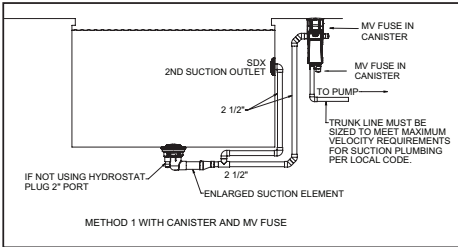

WITHOUT CANISTER

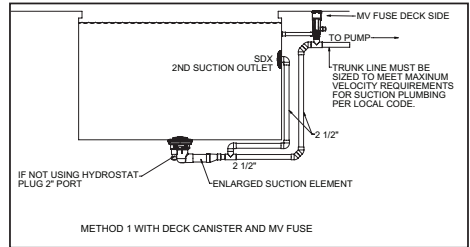

*Note: Canister requires 1 1/2" equalizer line through pool wall. (Not Shown)

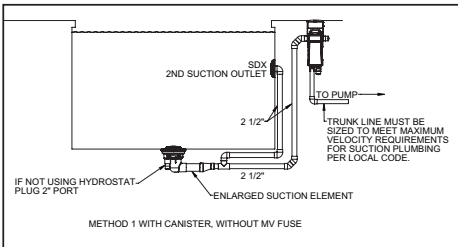

*Note: Canister requires 1 1/2" equalizer line through pool wall. (Not Shown)

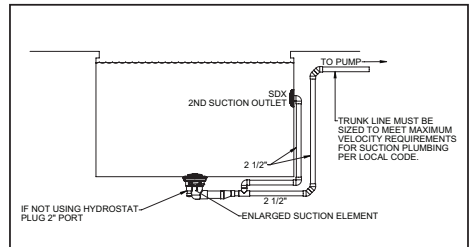

Compliant with ANSI/APSP - 7 - 2006

MDX-R3 INSTALLATION METHOD 2

WITH CANISTER

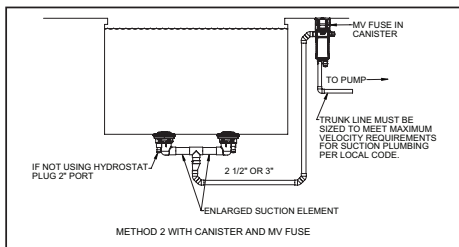

*Note: Canister requires 1 1/2" equalizer line through pool wall. (Not Shown)

WITHOUT CANISTER

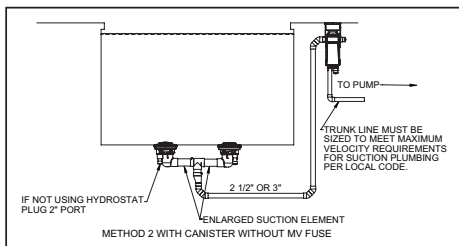
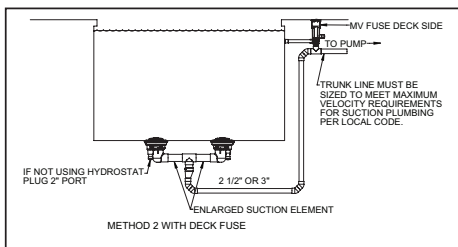

*Note: Canister requires 1 1/2" equalizer line through pool wall. (Not Shown)

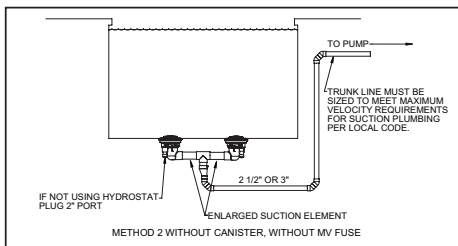

Compliant with ANSI/APSP - 7 - 2006

MDX-R3 INSTALLATION FOR CALIFORNIA

WITH CANISTER

WITHOUT CANISTER

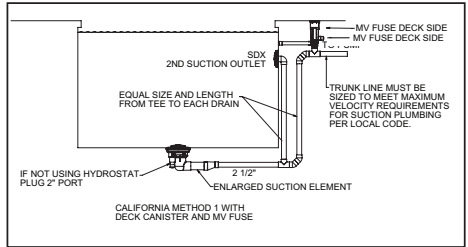
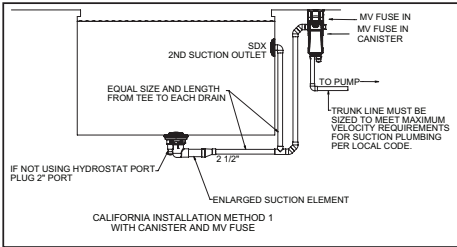

*Note: Canister requires 1 1/2" equalizer line through pool wall. (Not Shown)

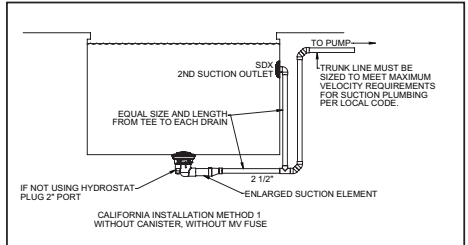
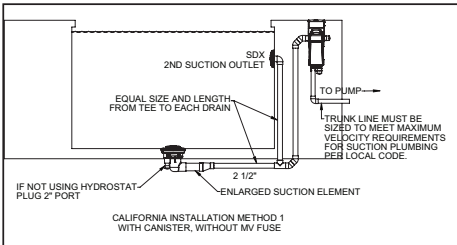

*Note: Canister requires 1 1/2" equalizer line through pool wall. (Not Shown)

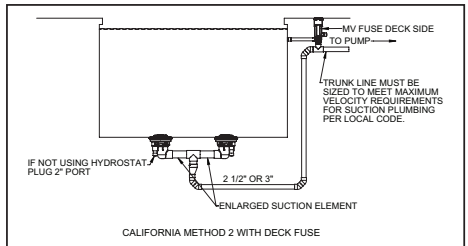
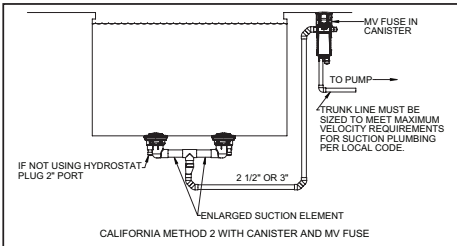

*Note: Canister requires 1 1/2" equalizer line through pool wall. (Not Shown)

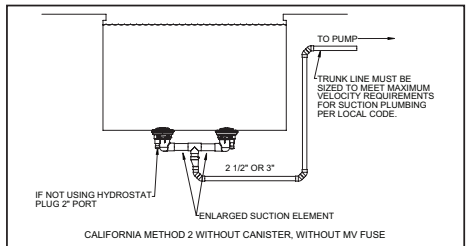
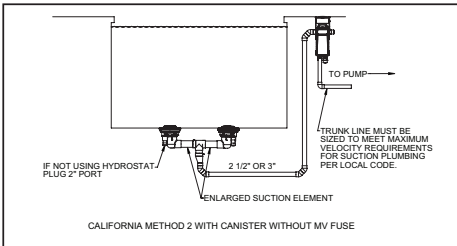

*Note: Canister requires 1 1/2" equalizer line through pool wall. (Not Shown)

Compliant with ANSI/APSP - 7 - 2006

MDX-R3 PLUMBING

MDX-R3 Plumbing (Fig. 1)

1. Position the top edge of the MDX-R3 sump 1" below the finished depth of the pool, spa, or a basin (Fig. 1). Finish concrete to top edge of construction cap. Orientate the sump so the elbow is perpendicular to inside wall or end wall of pool.
2. Position the REQUIRED SDX High Flow Safety Drain® on a sidewall of the pool below water level (if pool will be winterized, place it high enough to reach from the deck). Option: The SDX High Flow Safety Drain may be positioned on the floor a MINIMUM of three (3) feet away from any other Suction Outlet.

Fig. 1

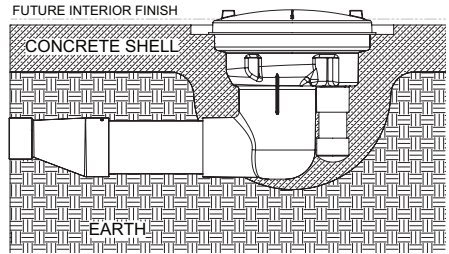

HYDROSTATIC FITTING

The hydrostatic port inside the MDX-R3 Sump is equivalent to a 2" Threaded Female Adapter and a 2" Slip Fitting Outside the MDX-R3 Sump. This port is for the purpose of a hydrostat only. Paramount recommends the use of the 2" thread plug provided. Do not use check valves here that are prone to sticking open causing the need to open the drain cover exposing a suction risk. If a hydrostat is not used, plug this port from bottom with pipe and cap. Do not install any suction equipment (pump) to this port!

MDX-R3 PRESSURE TESTING

Pressure Test-READ BEFORE INSTALLATION: New Style Test Plug

The 4" pressure test plugs (005-252-1610-00) use an o-ring to make the seal.

Wrap once with Teflon tape to prevent plastic threads from binding. Insert plug into threaded socket. Use an adjustable wrench, a 1 1/2" 12 pt socket or pliers on lug and tighten by hand until snug. Over tightening may cause parts to break.

Pressure should remain on the system through construction until interior cleanup.

Fig. 2

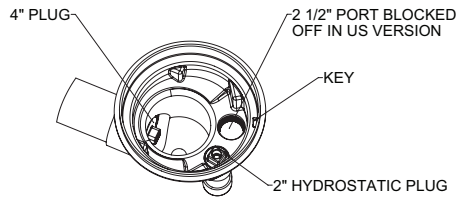

WARNING

Release pressure on the system before removing plugs

SDX CONCRETE INSTALLATION

The SDX High Flow Safety Drain® installed in a concrete shell utilizes a small cutout in the concrete to form the sump which is sometimes made of plastic or fiberglass. This concrete sump provides superior shell strength by eliminating the large hole associated with plastic sumps. The water seal is formed against the suction pipe in the same way a water tight seal is formed with return pipes. The concrete cutout is typically eleven (11) inches wide, by two (2) inches deep, with a finger size cutout around the pipe to allow room for a watertight seal. (Fig. 3)

Rebar Steel (Fig. 5)

Concrete reinforcing steel should be kept 3" away from all pipe and fittings.

Concrete Shell Sump (Fig. 3)

Form a concrete sump around each suction pipe.

Concrete Shell Preparation (Fig. 4)

Prior to installing the interior finish, cut each SDX riser pipe approximately 1" behind the concrete shell's surface.

NOTICE

Suction Safety Standards require that main drain grates used to cover concrete sumps, must have the suction pipe cut at least 1 1/2 times the pipe diameter behind the drain cover. This is to allow room for even water flow through all drain cover holes. This is not necessary with the SDX drain because the Patented Design provides uniform suction regardless of pipe location. However, if the pipe is too close to the surface, it may restrict water flow to the pump, reducing hydraulic efficiency, but this does not pose a suction safety hazard.

Fig. 3

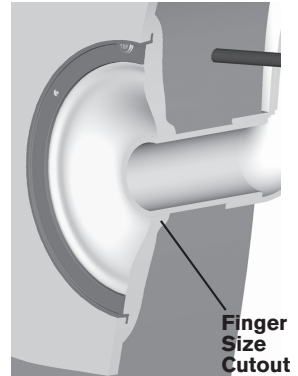
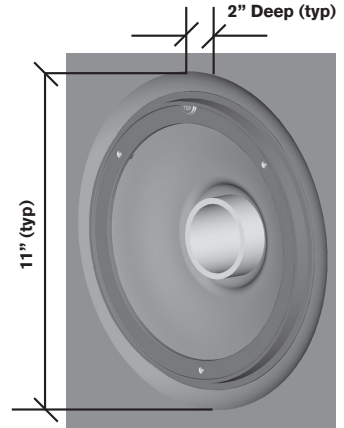
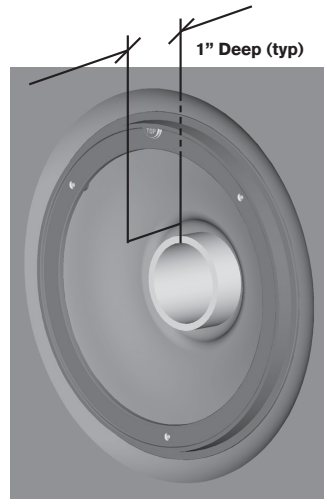

Fig. 4



Concrete Ring Installation (Fig. 5)

1. Apply interior finishing material.
2. Position the SDX Concrete Ring with the semi-circle tab located at the top and then press the ring into finishing material.
3. Trowel the finishing material around outside and inside of the SDX Concrete Ring.
4. Form a watertight seal around the suction pipe.
5. Wipe clean any finishing material that remains on the SDX Concrete Ring's top edge and mounting surface.

Fig. 5

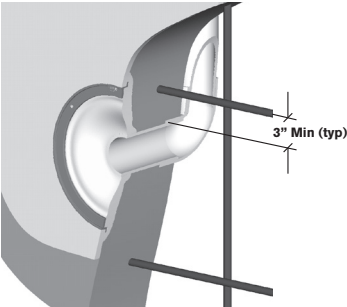

Concrete Cover Assembly (Fig. 6)

1. Align the SDX Concrete Support with the alignment tab located on the SDX Concrete Ring.
2. Install three (3) machine screws through the SDX Concrete Support. Secure the screws without over tightening.
3. Align the SDX Cover with the SDX Support holes.
4. Install three (3) security screws through the SDX cover. Secure the screws without over tightening.

Fig. 6

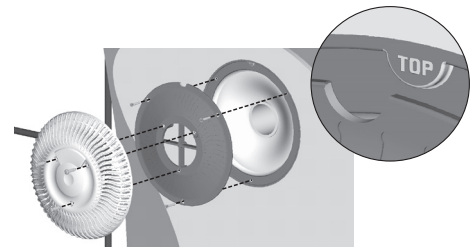

STEEL AND CONCRETE INSTRUCTIONS

Keep rebar 3" away from MDX-R3 sump. (Fig. 7)

1. To allow the sump to be fully encased in concrete, clear dirt to completely expose the sweep elbow. (Fig. 8)
2. Pack concrete around and under sump (Fig. 8) to ensure seal and strength of shell
3. Angle shell down to MDX-R3 sump. (Fig. 8)
4. Make cut-out around MDX-R3 sump. 17 1/4" round by 3/4" deep to water stop down. (Fig. 9 & 11)

Fig. 7

MDX-R3 DEBRIS REMOVAL SYSTEM STANDARD POOL/SPA/BASIN DESIGN STEEL CAGE

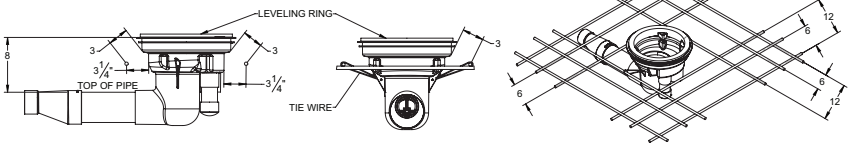

Fig. 8

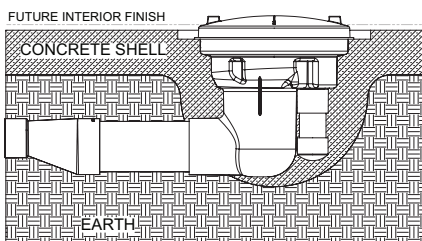
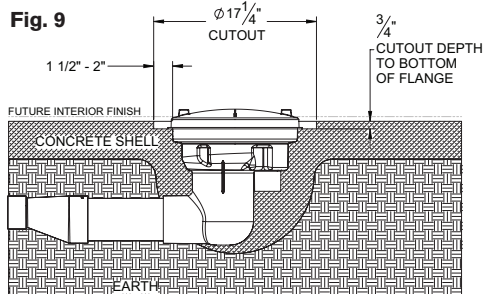

Fig. 9



Plaster Ring Installation:

The Concrete Ring should be attached to the MDX-R3 Sump prior to finishing the interior surface of the pool, spa, or basin.

1. Remove all plugs before starting final finish application. Use an adjustable wrench or pliers to remove 4" plug. Set the leveling ring at final finish.
2. Align the Leveling Ring Keyway with the Sump Alignment Key. (Fig. 10)
3. Adjust the elevation and the angle of the Leveling Ring to align it with the finished interior surface of the pool, spa, or basin.
4. Use a sealing compound compatible with the interior surface to lock the Concrete Ring in place and to provide a water-tight seal.

*Sealing compound example: Topping Mix Cement, hydraulic cement, and Thoro Acryl®60 by ChemRex® or equivalent.

Assemble the drain PRIOR TO ADDING WATER

(see illustration on page 12 for reference):

1. Remove 4" pressure plug.
2. Install funnel assembly (#3) onto leveling ring (#5) and secure with 4 (four) security screws (#2) with screw driver security T25 (#15).
3. Install the cover (#1) onto the funnel assembly (#3) and secure with 3 (three) security screws (#2).

Fig. 10

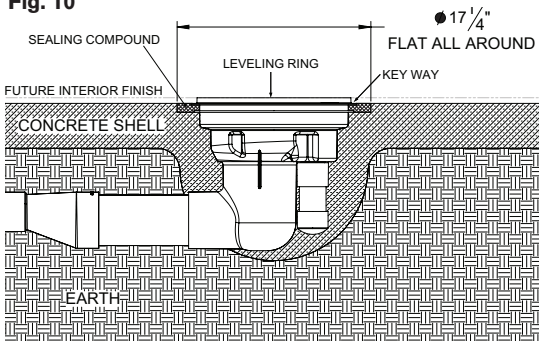
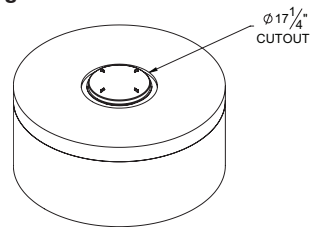

Fig. 11



MDX-R3 WINTERIZATION

WITH CANISTER

If vacuum relief suction outlets are located below freeze line skip steps 1 and 2.

1. Remove grate from wall drain and install a 13- $\frac{3}{4}$ blow through plug and blow line to achieve airlock.
2. If 3rd suction line is installed remove grate, install a 13- $\frac{3}{4}$ blow-through plug and blow line to achieve airlock.
3. If vent tube is installed, install blow through plug and blow line to achieve airlock. Repeat vacuum out canister. For winterizing canister visit www.1Paramount.com and click on winterization instructions.

WITHOUT CANISTER

If vacuum relief suction outlets are located below freeze line skip steps 1 and 2.

1. Remove grate from wall drain and install a 13- $\frac{3}{4}$ blow through plug and blow line to achieve airlock.
2. If 3rd suction line is installed remove grate, install a 13- $\frac{3}{4}$ blow-through plug and blow line to achieve airlock.
3. If vent line is installed in main suction line, plug vent line and install blow through plug in pump inlet and blow line to achieve airlock.
4. Lastly, blow vent line to achieve airlock.

Replace cover within 05 installed years

Available Construction Caps

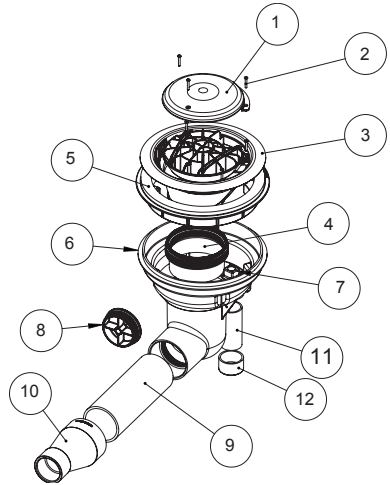
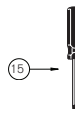
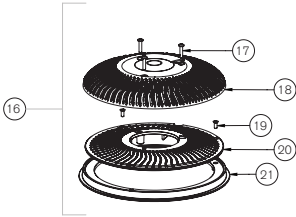

Item	Part Number	Description
1	005-252-2110-XX	Cover (XX = Color Code)
2	005-262-0840-00	Screw Pack (7pcs)
3	005-252-8234-XX	Funnel Assembly (Includes Support, Cover, Screws and Adaptor)
4	005-252-1045-00	Funnel Adaptor
5	005-252-2045-00	Leveling Ring
6	005-262-2028-00	Sump
7	005-252-1605-00	2" Plug NPT (6pcs)
8	005-252-1610-00	4" Plug with O-Ring
9	005-252-5524-00	Enlarged Suction Element
10	005-252-2550-00	Coupler Reducer 4" X 2½"/3"
*11		2" Pipe - Not Included - Cap If Not Used
*12		2" Cap - Not Included - Cap If Not Used
*13	005-262-1153-00	Plaster Cap
14	005-262-1150-00	Sump Construction Cap
15	005-252-0895-00	T25 Security Screwdriver
16	004-162-2212-XX	SDX High Flow Safety Drain (2pc)
17		Screw: 10 X 7/8 TORX W/PIN SS B (12 pcs)
18	005-252-2084-XX	SDX Cover With Screws
19		Screw: 10-32 x ½ PHIL LFT HD machines 316SS (12 pcs)
20	005-252-2066-00	SDX Support Concrete
21	005-252-2050-00	SDX Ring Concrete
*	005-252-0810-00	Screw Pack SDX Concrete

* Not part of MDX-R3