

3832TR/3832HDTR

- Touch release - push drawer front to open or close
- Load rating up to 45kg
- Stay-closed feature
- Heavy duty stay-closed option 3832HDTR
- 100% extension
- 12.7mm slide thickness
- Front disconnect
- Hold-in
- Cam drawer adjust (3.2mm)

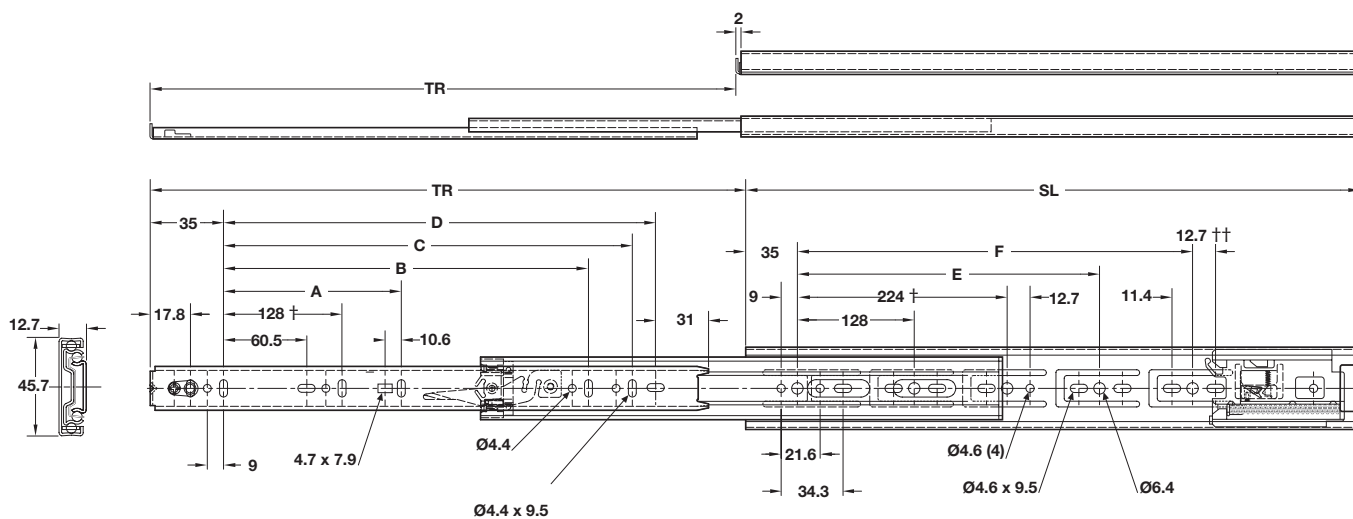

† Hole not available for 3832-0030TR/HDTR
 †† Hole not available for 3832-0040/50/60TR/HDTR



3832TR/3832HDTR

3832TR/ 3832HDTR	mm							
	SL	TR	A	B	C	D	E	F
*3832-0030TR	300	305	-	-	-	192	-	-
DZ3832-0030HDTR	300	305	-	-	-	192	-	-
*3832-0035TR	350	356	-	-	-	242	-	-
DZ3832-0035HDTR	350	356	-	-	-	242	-	-
*3832-0040TR	400	406	-	-	-	292	288	-
DZ3832-0040HDTR	400	406	-	-	-	292	288	-
*3832-0045TR	450	457	-	320	-	342	320	-
DZ3832-0045HDTR	450	457	-	320	-	342	320	-
*3832-0050TR	500	508	-	320	-	392	384	-
DZ3832-0050HDTR	500	508	-	320	-	392	384	-
*3832-0055TR	550	559	224	416	-	442	416	-
DZ8328-0055HDTR	550	559	224	416	-	442	416	-
*3832-0060TR	600	610	224	416	-	492	352	480
DZ3832-0060HDTR	600	610	224	416	-	492	352	480
*3832-0065TR	650	660	224	416	512	542	352	512
DZ3832-0065HDTR	650	660	224	416	512	542	352	512
*3832-0070TR	700	711	224	416	512	592	352	544
DZ3832-0070HDTR	700	711	224	416	512	592	352	544

* 3832TR only prefix DZ for bright zinc plate, DB for black zinc plate, DW for white electro-plate

Notes:

- Fixing recommendation: 4mm wood screw / 6mm Euro screw
- Drawer opens 50mm - 125mm when pushed in
- Use for side (vertical) mount only
- Drawer width should not exceed slide length
- Not for lateral file drawer applications or where the drawer is wider than it is deep