







833.72.478
833.75.178

LED 2091
LED 3091

<div style="display: flex; gap: 5px;"> <div style="border: 1px solid black; padding: 2px; font-size: 8px;">12 V System</div> <div style="border: 1px solid black; padding: 2px; font-size: 8px;">24 V System</div> </div>	K		T_A	
833.72.478	2700 - 5000 K	Ø 61.2 x 15.6	-20 °C – +45 °C -4 °F – +113 °F	<div style="border: 1px solid black; padding: 2px; font-size: 8px;">Loox 12 V</div>
833.75.178	2700 - 5000 K			<div style="border: 1px solid black; padding: 2px; font-size: 8px;">Loox 24 V</div>

732.28.336

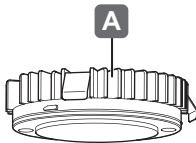

A

+

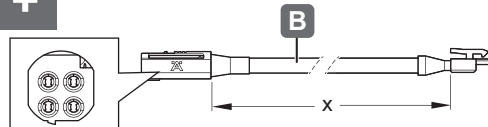

B

x	12V
2000	833.95.787

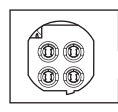

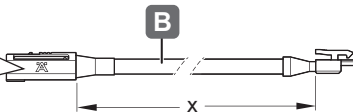

B

x	24V
2000	833.95.790

+

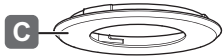

C

833.72.126 <input type="checkbox"/>	833.72.380 <input type="checkbox"/>
	833.72.381 <input type="checkbox"/>
	833.72.382 <input type="checkbox"/>
	833.72.168 <input type="checkbox"/>
	833.72.170 <input type="checkbox"/>
	833.72.171 <input type="checkbox"/>

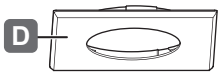

D

833.72.127 <input type="checkbox"/>	833.72.383 <input type="checkbox"/>
	833.72.384 <input type="checkbox"/>
	833.72.385 <input type="checkbox"/>
	833.72.172 <input type="checkbox"/>
	833.72.174 <input type="checkbox"/>
	833.72.175 <input type="checkbox"/>

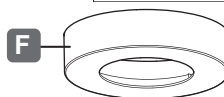

F

833.72.124 <input type="checkbox"/>	833.72.193 <input type="checkbox"/>
	833.72.192 <input type="checkbox"/>
	833.72.194 <input type="checkbox"/>
	833.72.160 <input type="checkbox"/>
	833.72.162 <input type="checkbox"/>
	833.72.163 <input type="checkbox"/>

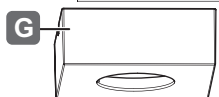

G

833.72.125 <input type="checkbox"/>	833.72.195 <input type="checkbox"/>
	833.72.196 <input type="checkbox"/>
	833.72.197 <input type="checkbox"/>
	833.72.164 <input type="checkbox"/>
	833.72.166 <input type="checkbox"/>
	833.72.167 <input type="checkbox"/>



E

2x



E

2x

HDE 28.03.2022

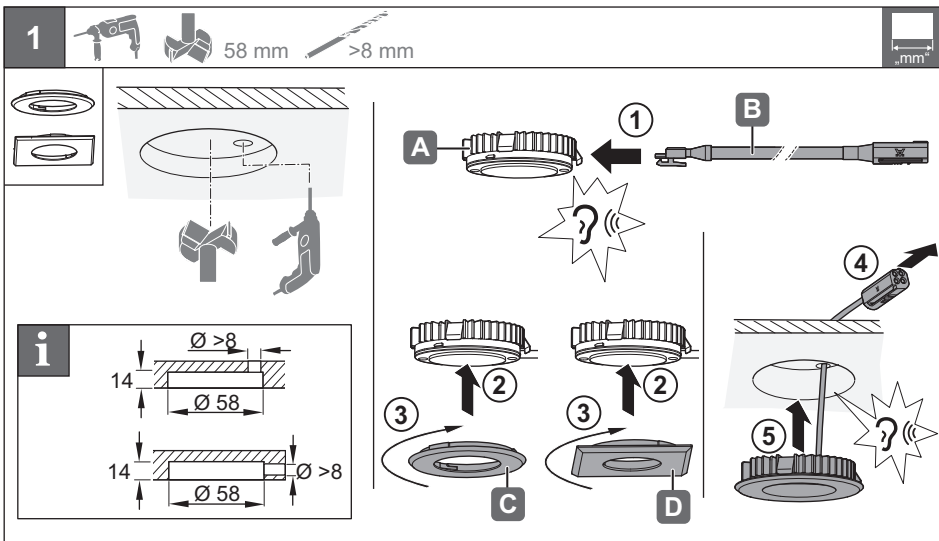
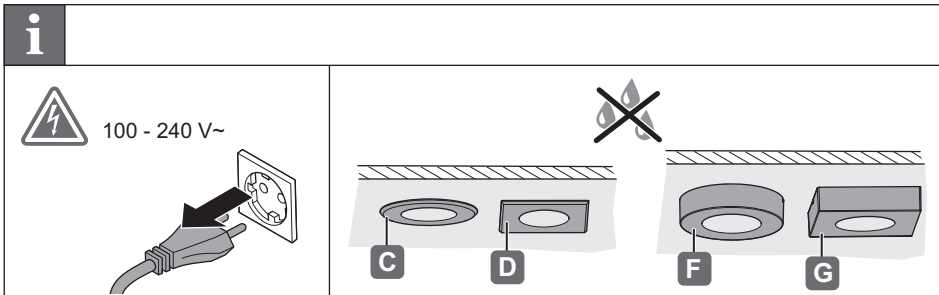

1



mm

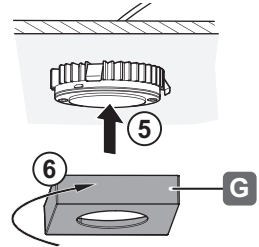
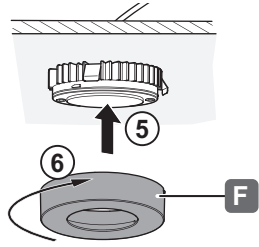
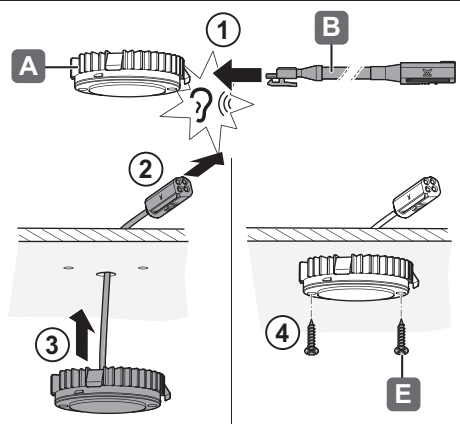
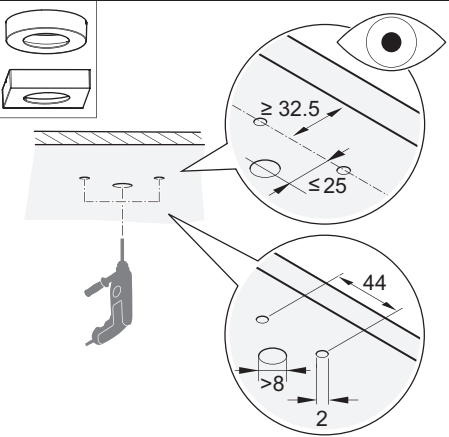

2

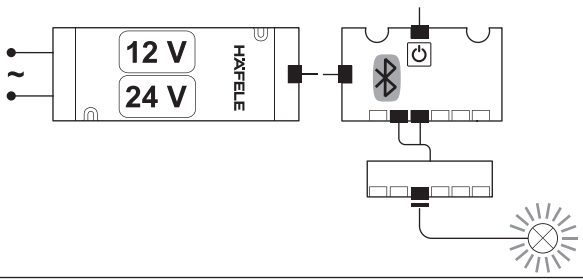

732.28.336

HDE 28.03.2022

732.28.336

HDE 28.03.2022