

# HÄFELE

## Installation Instructions: Vertical Double/Full Wall Bed Kit

Item Number: 271.92.202



**TIP-OVER HAZARD**  
Serious or fatal crushing injuries can occur from furniture tip-over. To prevent, furniture **MUST** be permanently fixed to the wall.



\* Professional installation recommended.

## ANSI SAFETY COLOR CODES

<b>DANGER</b>	An immediately hazardous situation. If the hazardous situation is not avoided, death or serious injury will occur.
<b>WARNING</b>	A potentially hazardous situation. If the hazardous situation is not avoided, death or serious injury could occur.
<b>CAUTION</b>	A potentially hazardous situation. If the hazardous situation is not avoided, minor or moderate injury could occur.
<b>NOTICE</b>	A property-damage-only hazard, meaning no personal injury is possible.

## CALIFORNIA PROPOSITION 65

**WARNING**

Drilling, sawing, sanding or machining wood products can expose you to wood dust, a substance known to the State of California to cause cancer. Avoid inhaling wood dust or use a dust mask or other safeguards for personal protection. For more information go to [www.P65Warnings.ca.gov/wood](http://www.P65Warnings.ca.gov/wood)

## GENERAL SAFETY WARNINGS

To avoid serious risk of injury and ensure the proper functioning of the wall bed mechanism, the following safety measures **MUST** to be followed:

### **DANGER CHOICE OF LOCATION WARNINGS**

1. Cabinet for the vertical double wall bed **MUST** be secured to 3 wooden wall studs with the included hardware.
2. Do **NOT** use wall anchors or drywall anchors to secure the cabinet to the wall.
3. The included hardware is not intended to attach to masonry, brick or metal studs. Failure to use proper hardware could undermine the structural integrity of your cabinet and increases the risk of cabinet failure and serious personal injury.

### **DANGER PRODUCT SPECIFIC WARNINGS**

4. Do **NOT** deviate from the required interior cabinet dimensions listed on page 5. A cabinet that is not properly sized **WILL** cause the mechanism to fail which could create serious safety hazards.
5. Do **NOT** modify the design of the cabinet by removing components/panels. A cabinet/mechanism that is not properly assembled **WILL** cause the mechanism to fail which could create serious safety hazards or damages as the wall bed could detach from the wall.
6. Do **NOT** construct the full cabinet in particleboard or MDF. A cabinet that is not in the proper material **WILL** cause the mechanism to fail which could create serious safety hazards or damages as the wall bed could detach from the wall. See page 5 for more details on acceptable material per panel component.

### **WARNING INSTALLER & USER WARNINGS**

7. Do **NOT** allow children to play with or operate the assembled product without adult supervision.
8. Installation of the wall bed mechanism and cabinet **MUST** be done with two adults. Failure to do so increases the risk of serious injury.
9. Do **NOT** use a foam or very light mattress with this mechanism as this could cause the mechanism to close very fast and in a dangerous manner.

## LOAD RATINGS

Dynamic Load Rating	Static Load Rating
159kg (350lbs)	408kg (900lbs)

Rating takes into account the weight of the front panels (doors), mattress, hardware, bedding & user(s).













**TIP-OVER HAZARD**  
Serious or fatal crushing injuries can occur from furniture tip-over. To prevent, furniture **MUST** be permanently fixed to the wall.



















## RECOMMENDED SIZES & WEIGHTS

Average front panel	Mattress	Comfort Slat Kit or Plywood Sheet	Combined Lifting Capacity
80lbs	55-80lbs	30-35lbs	165-195lbs

Wall bed will not operate properly unless the above weight ranges are adhered to. Do **NOT** exceed load ratings.

## HARDWARE FOR DOUBLE/FULL WALL BED MECHANISM

A		Left and right frame structure (Pair)	x1
B		Head and foot frame structure (Pair)	x1
C		Middle horizontal frame support	x3
D		Head and foot center frame support	x2
E		Middle vertical frame support	x2
F		Mounting plate set (left and right)	x1
G		1600N Non-locking pistons	x2
H		Mattress support	x2
I		M6 x 15mm Bolt	x32
J		Saddle locking plate	x2
K		Door bracket for adjustability	x12
L		Leg set (Pair)	x1
M		Through bolt (Male part) only	x12

N		Through bolt (Female part) only	x12
O		Wrench	x1
P		Hex Key #4	x1
Q		Hex Key #5	x1
R		#10 x 35mm screw	x32
S		#8 x 15mm screw	x142
T		M5 x 15mm bolt	x2
U		M5 Locking nut (for saddle lock)	x2
V		M8 Locking nut	x6
X		1/4 x 20 Hex head screw fully threaded	x3
Y		#12 x 5/8 washer head screw (20 additional screws are provided with FF & GG)	x6
Z		1/4 x 3" washer head lag bolt fully thread	x6
AA		Safety bracket to attach wall bed to wall	x3
CC		Tube (for connecting the legs)	x1
DD		Nylon Washers (for leg pivot point)	x4
EE		Temporary structure stopper	x2
FF		Bracket for mechanism cover (Pair) (Optional accessories, provided in a separate kit)	x1
GG		Mechanism cover (Pair) (Optional accessories, provided in a separate kit)	x1

## CABINET DIMENSIONS BASED ON LEG MODEL

Choose cabinet dimensions to cut based on the model of leg that you will be using. Height of the leg affects the height and depth of the cabinet as well as the drilling pattern height for the mechanism.

A

Page 5  
Cabinet dimensions  
for **standard leg**



OR

B

Page 5B-Tall  
Cabinet dimensions  
for **tall leg** with  
adjustable glides.



### NOTICE

For the cabinet and mechanism to function properly together, cabinet dimensions based on leg model **MUST** be chosen properly.

A

### Double Vertical - Overall Cabinet Dimensions - STANDARD LEG VERSION

	Inside Measurements [mm (in)]		
	Width	Depth	Height
Double	1506 (59-5/16")	368 (14-1/2")	2030 (79-15/16")

	Outside Measurements [mm (in)]		
	Width	Depth	Height
Double	1544 (60-13/16")	406 (16")	2068 (81-7/16")

\*All measurements are for 19mm (3/4") board



**WARNING** The internal dimensions **MUST** be consistent with the instructions to maintain safety & optimal functionality.

### Cabinet Parts Dimension Guide

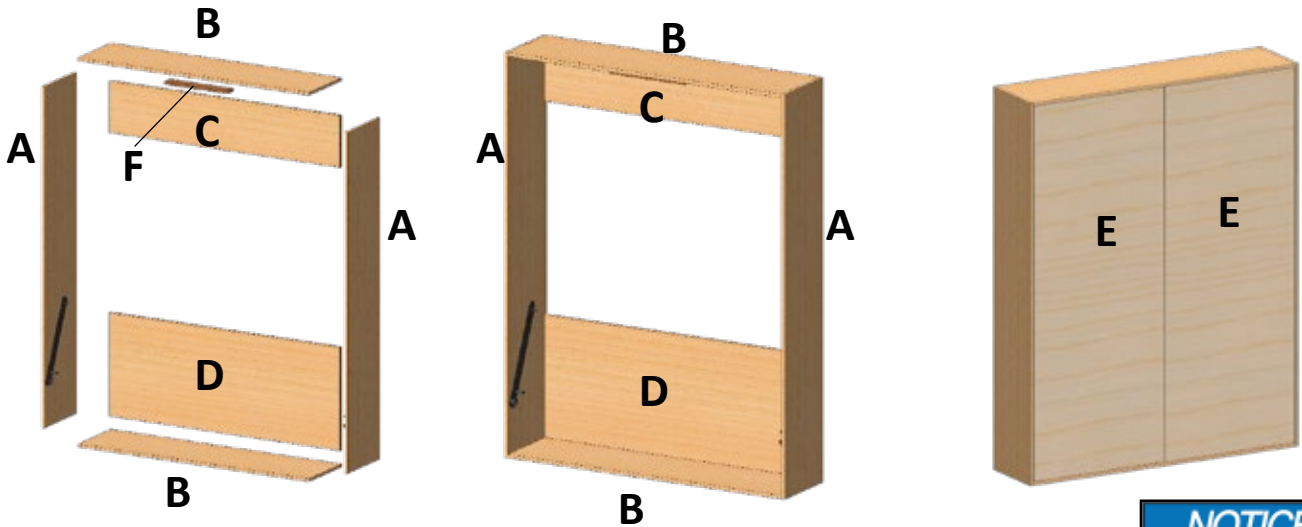

#### DOUBLE WALL BED PANEL DIMENSIONS [mm (in)]

#	Qty	Width	Length	Thickness	Recommended Materials
A	2	406 (16")	2068 (81-7/16")	19 (3/4")	Melamine, Plywood, Hardwood
B	2	406 (16")	1506 (59-5/16")	19 (3/4")	Melamine, Plywood, Hardwood
C	1	330 (13")	1506 (59-5/16")	19 (3/4")	Melamine, Plywood, Hardwood
D	1	660 (26")	1506 (59-5/16")	19 (3/4")	Melamine, Plywood, Hardwood, MDF
E	2	748 (29-7/16")	2013 (79-1/4")	19 (3/4")	Melamine, Plywood, Hardwood, MDF
F	1	75 (2-15/16")	455 (17-15/16")	19 (3/4")	Melamine, Plywood, Hardwood, MDF

### NOTICE

Toe kick is **NOT** possible with the standard legs. If you want a toe kick, please use tall leg and refer to page 5B.

# B

## Double Vertical - Overall Cabinet Dimensions - TALL LEG VERSION

	Inside Measurements [mm (in)]		
	Width	Depth	Height
Double	1506 (59-5/16")	429 (16-7/8")	2091 (82-5/16")

	Outside Measurements [mm (in)]		
	Width	Depth	Height
Double	1544 (60-13/16")	467 (18-3/8")	2129 (83-13/16")

\*All measurements are for 19mm (3/4") board

**WARNING** The internal dimensions MUST be consistent with the instructions to maintain safety & optimal functionality.

### Cabinet Parts Dimension Guide

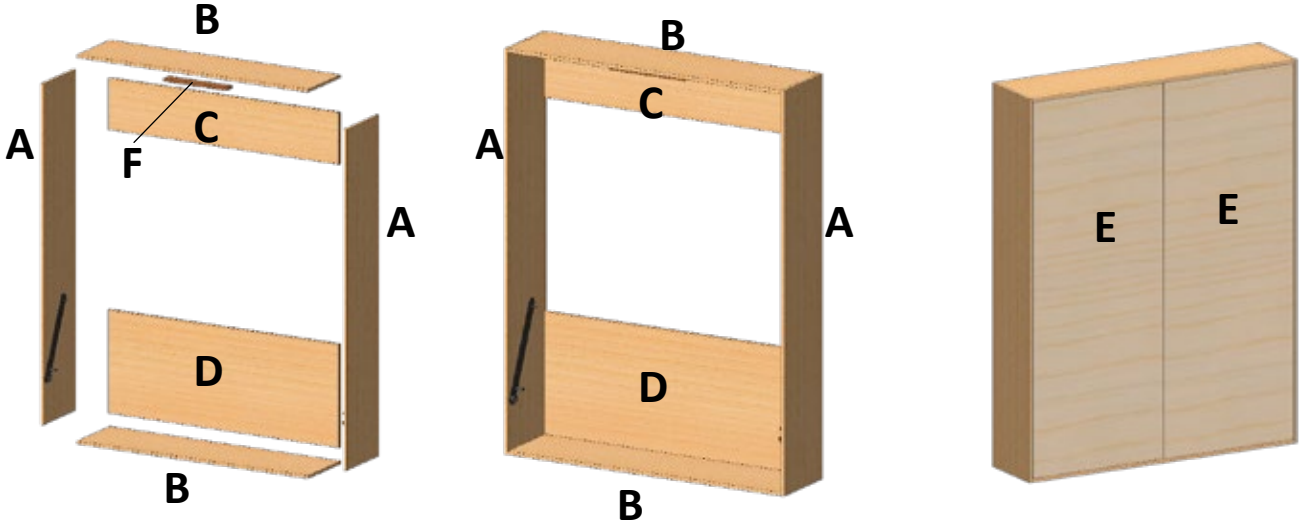

#### DOUBLE WALL BED PANEL DIMENSIONS - NO TOE KICK [mm (in)]

#	Qty	Width	Length	Thickness	Recommended Materials
A	2	467 (18-3/8")	2129 (83-13/16")	19 (3/4")	Melamine, Plywood, Hardwood
B	2	467 (18-3/8")	1506 (59-5/16")	19 (3/4")	Melamine, Plywood, Hardwood
C	1	330 (13")	1506 (59-5/16")	19 (3/4")	Melamine, Plywood, Hardwood
D	1	660 (26")	1506 (59-5/16")	19 (3/4")	Melamine, Plywood, Hardwood, MDF
E	2	748 (29-7/16")	2074 (81-5/8")	19 (3/4")	Melamine, Plywood, Hardwood, MDF
F	1	75 (2-15/16")	455 (17-15/16")	19 (3/4")	Melamine, Plywood, Hardwood, MDF

\* Suggested dimensions for 19mm (3/4") board.

#### NOTICE

Due to tall leg and toe kick option, component dimensions change. Do **NOT** use dimensions provided on page 5A if using a tall leg. Components highlighted in BLUE SQUARE are longer and/or wider due to tall leg.

#### DOUBLE WALL BED PANEL DIMENSIONS - WITH A TOE KICK [mm (in)]

#	Qty	Width	Length	Thickness	Recommended Materials
A	See table above for tall leg, dimension does not change with a toe kick.				
B-Top	1	467 (18-3/8")	1506 (59-5/16")	19 (3/4")	Melamine, Plywood, Hardwood
B-Bottom	1	448 (17-5/8")	1506 (59-5/16")	19 (3/4")	Melamine, Plywood, Hardwood
C	See table above for tall leg, dimension does not change with a toe kick.				
D	See table above for tall leg, dimension does not change with a toe kick.				
E	2	748 (29-7/16")	2013 (79-1/4")	19 (3/4")	Melamine, Plywood, Hardwood, MDF
F	See table above for tall leg, dimension does not change with a toe kick.				
Toe Kick	1	61 (2-7/16")	1506 (59-5/16")	19 (3/4")	Melamine, Plywood, Hardwood, MDF

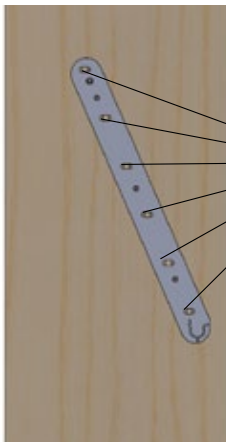

**STANDARD LEG DRILLING PATTERN + 61mm = TALL LEG DRILLING PATTERN**

Raise drilling pattern by 61mm (2-7/16") compared to drilling pattern of standard leg and adjust accordingly.

Do **NOT** change depth.

See Standard Double Instruction for original drilling pattern on page 6 for more details.

DRILLING GUIDE FOR "F" BRACKET

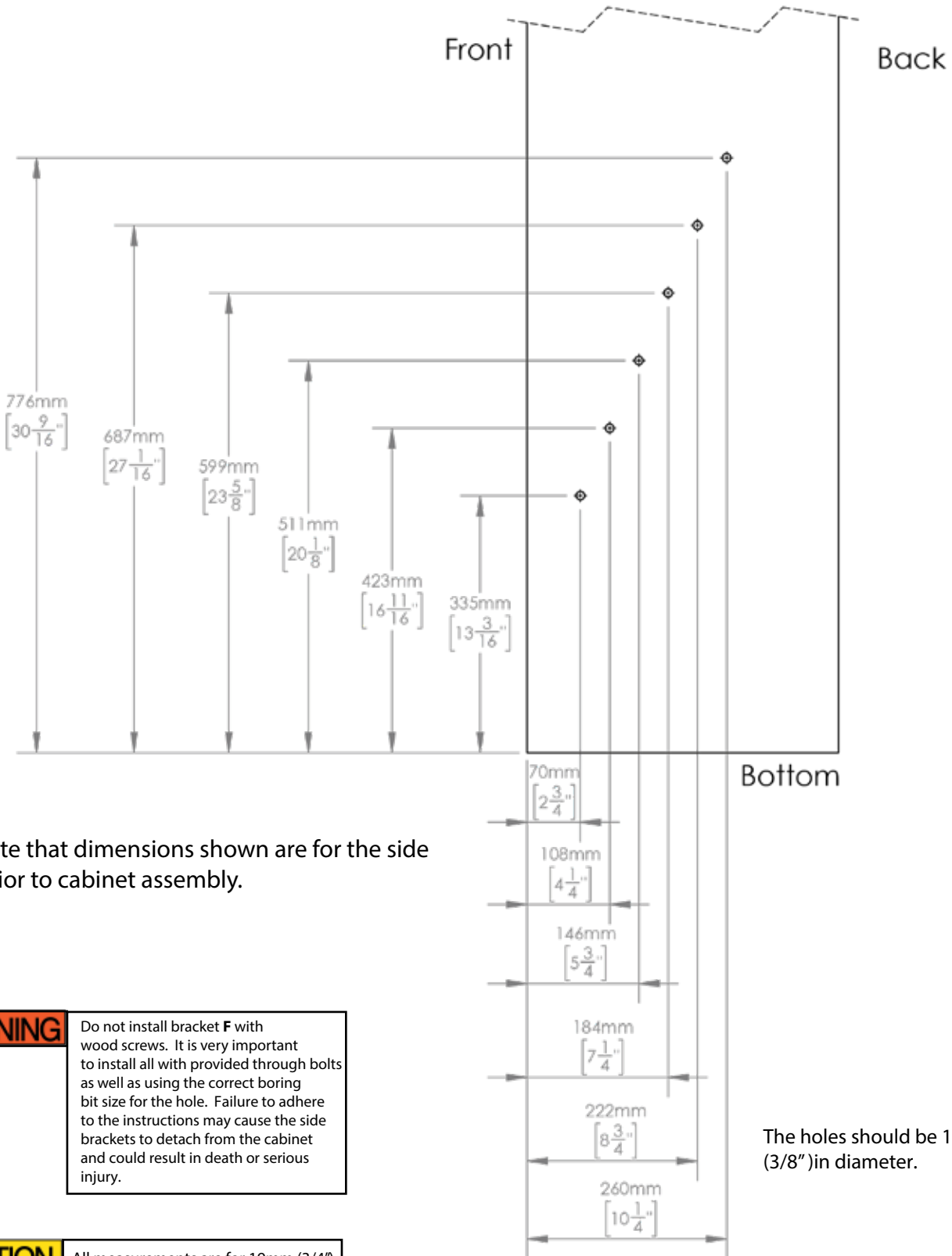

\* Please note that dimensions shown are for the side panels prior to cabinet assembly.

**WARNING**

Do not install bracket **F** with wood screws. It is very important to install all with provided through bolts as well as using the correct boring bit size for the hole. Failure to adhere to the instructions may cause the side brackets to detach from the cabinet and could result in death or serious injury.

**CAUTION**

All measurements are for 19mm (3/4") thick board. Do not use less than 19mm (3/4") board for wall bed cabinets.

The holes should be 10mm (3/8") in diameter.

# 1 INSTALLING THE MOUNTING BRACKETS:

This installation is drilled through the cabinet sides.

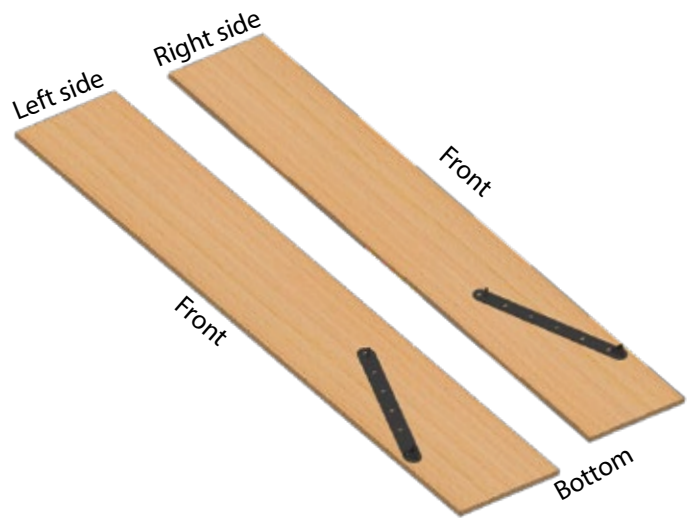
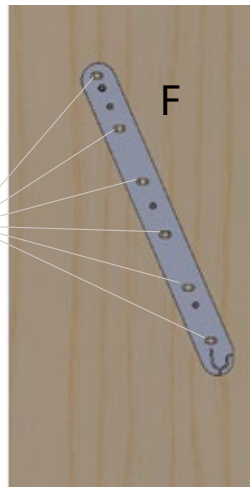
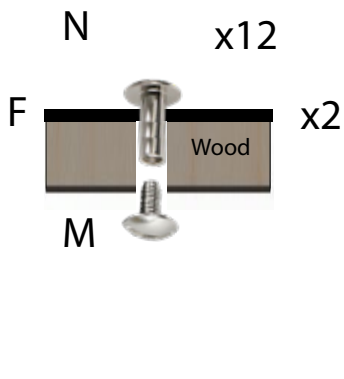

## WARNING

Do not install bracket F with wood screws. It is very important to install all with provided through bolts as well as using the correct boring bit size for the hole. Failure to adhere to the instructions may cause the side brackets to detach from the cabinet and could result in death or serious injury.

\*\*See the previous page for drilling guide.

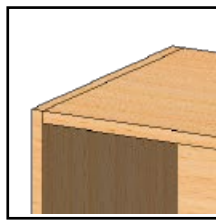

Cabinet sides overlay for a more secure assembly..

# 2 ASSEMBLING THE CABINET

Make sure the cabinet is level.



## WARNING

Please use appropriate hardware to assemble these corners according to the material used. Failure to properly assemble the cabinet may cause it to open and result in injuries.

## DANGER

Remove any trim from the base of the wall so that the back of the cabinet is completely against the wall. Failure to do this may cause the cabinet to detach from the wall and cause serious injury or death.



### 3 SECURING TO THE WALL



#### **⚠ DANGER**

Professional installation recommended.  
Cabinet needs to be secured into at least 3 wood studs.  
Do NOT use nylon or other wall anchors.





Bracket AA needs to be flush to the bed and flush to the wall with no gap between the components.

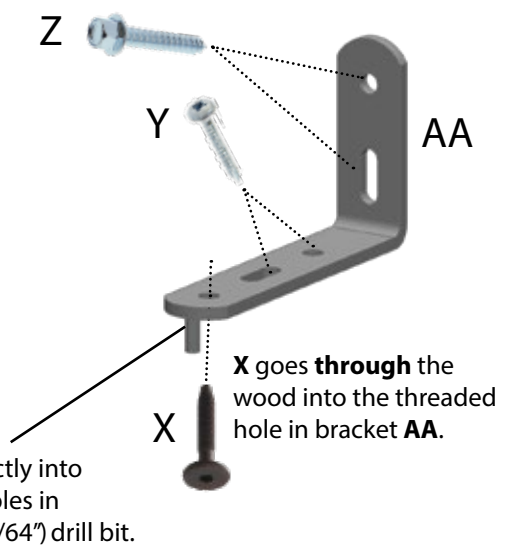

**TIP-OVER HAZARD**  
Serious or fatal crushing injuries can occur from furniture tip-over. To prevent, furniture MUST be permanently fixed to the wall.



Steel dowel goes directly into the wood top. Drill holes in panel with a 5mm (13/64") drill bit.

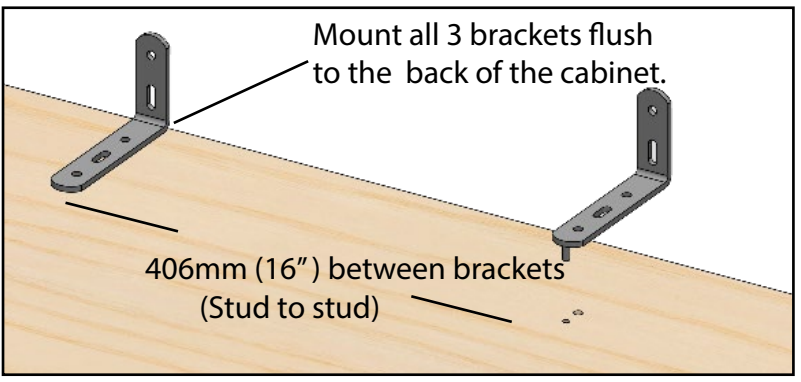

- Y**  x6
- X**  x3
- Z**  x6
- AA**  x3

**NOTE:** Due to stud placement in the wall versus the desired position of the bed, it is possible that the brackets will not be exactly at the center of the cabinet.



### 4 ASSEMBLING THE FRAME

**4.1**  
Attach **D** to **B**. Attach **H** to **B** for the head of bed.

- P** 
- B**  x2
- D**  x2

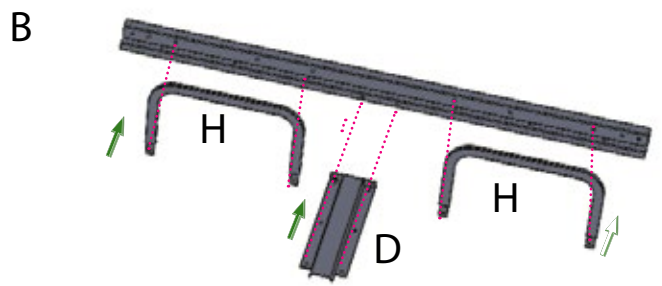

- H**  x2
- I**  x8

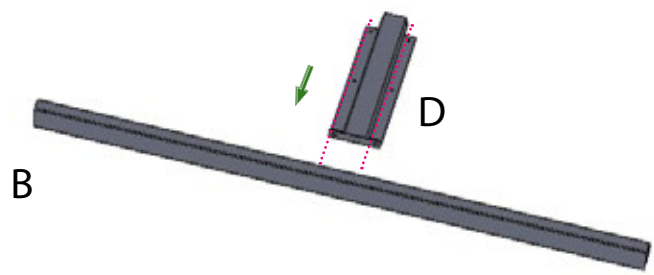

## 4.2

Insert **A** onto **B** and attach them together with **I**. Attach **C** to **A** with **I**.

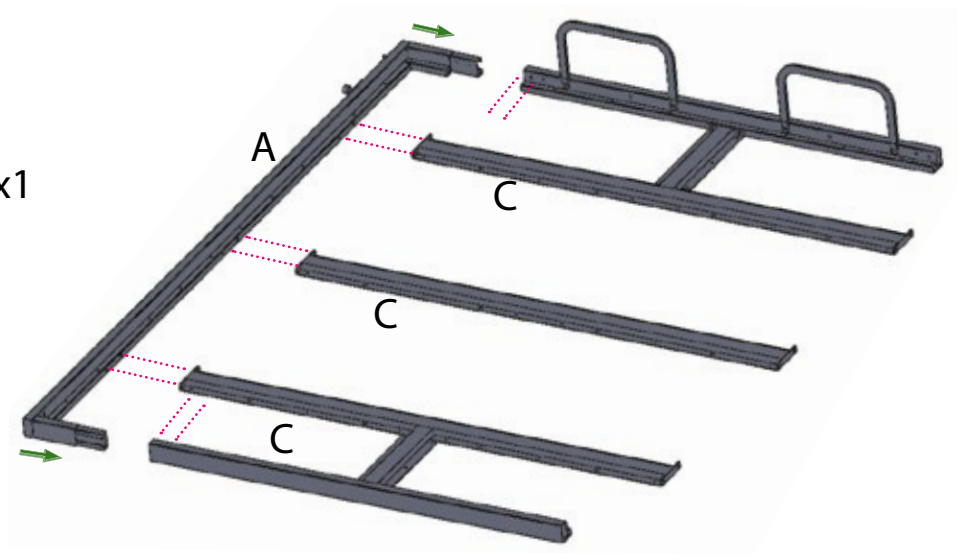
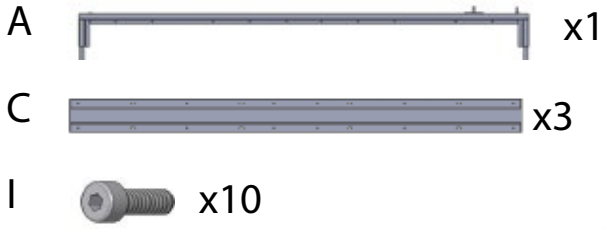

## 4.3

Insert the second **A** onto **B** and attach them together with **I**. Attach **C** to **A** with **I**.

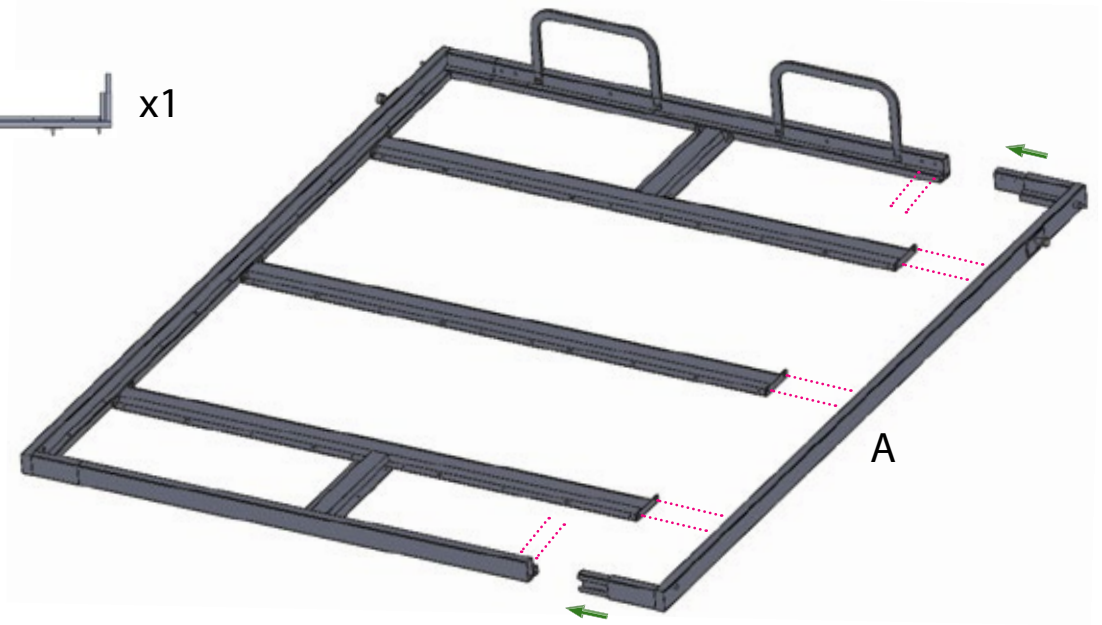

# 5 ATTACHING THE PISTONS TO THE FRAME

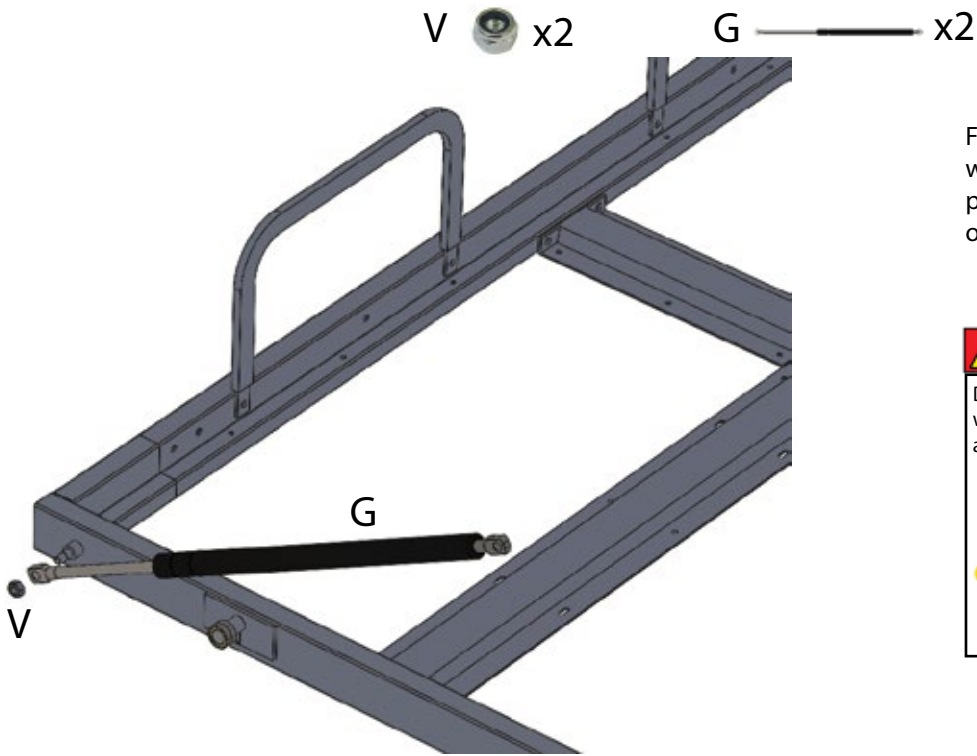

Follow the arrows on the piston indicating which side is "up" in order to install the piston properly and ensure the longevity and proper operation of the piston.

**⚠ DANGER**

Do NOT unscrew the cabinet from the wall once the mechanism or pistons are in place.

**⚠ TIP-OVER HAZARD**  
 Serious or fatal crushing injuries can occur from furniture tip-over. To prevent, furniture **MUST** be permanently fixed to the wall.

# 6 INSTALLING THE FRAME ONTO THE MOUNTING BRACKETS

Place the bearings into the saddles on both of the mounting brackets. Secure the bearings in place with:

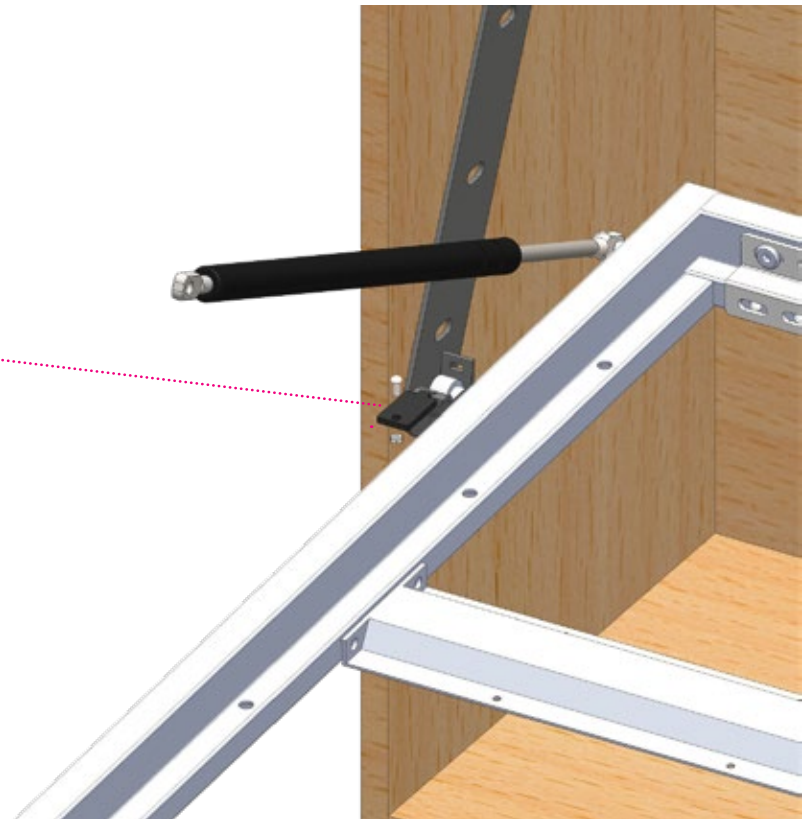
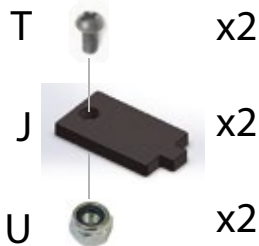

**⚠ DANGER**

Do NOT unscrew the cabinet from the wall once the mechanism or pistons are in place.

**⚠ TIP-OVER HAZARD**  
 Serious or fatal crushing injuries can occur from furniture tip-over. To prevent, furniture **MUST** be permanently fixed to the wall.

# 7 INSTALLING THE DOOR BRACKETS

The door brackets must point downward. Install the door brackets in alignment with the support bars on the bed frame.

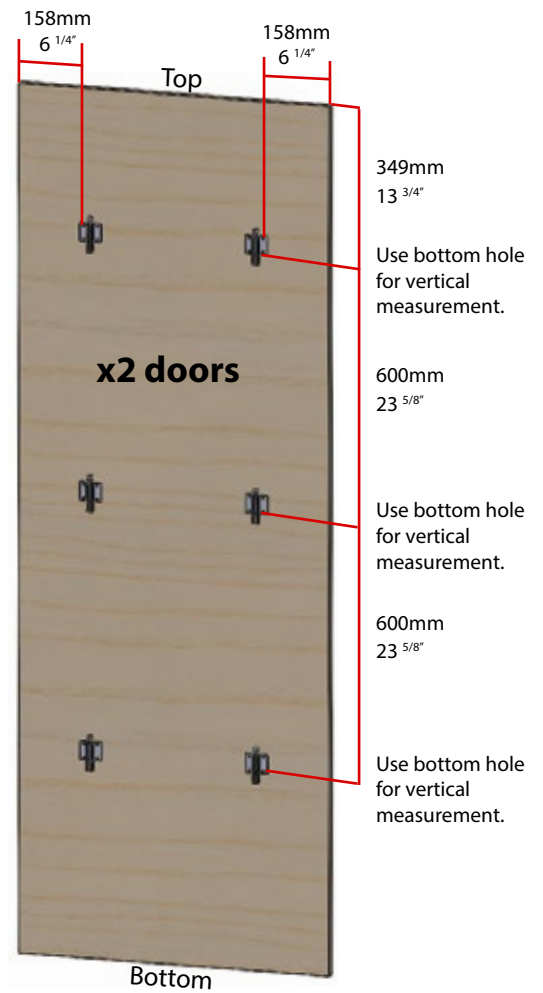
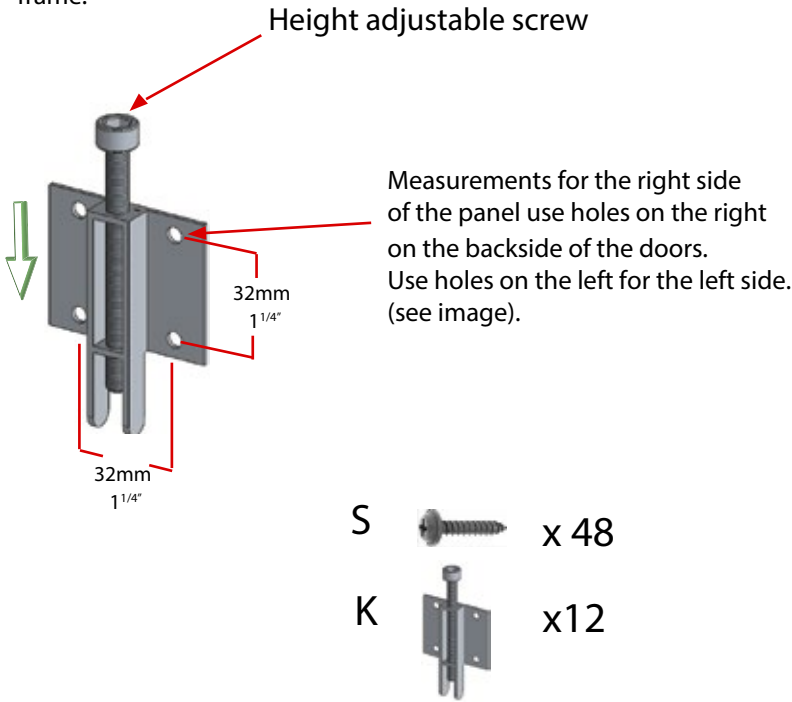

# 8 INSTALLING THE HANDLES

The door handles should be installed prior to mounting the doors in order to help hold the panels. Decorative handles not included. Install the handle on the outside of the door during this step. Handle should be mounted at a height to comfortably allow the user to pull the bed down. **MAKE SURE TO MIRROR** measurement for left and right doors.



Do not put handle screw hole closer than 65mm (2.5in) from the edge of each door panel to avoid interference with other components.

## CAUTION

It is not recommended to use knobs on wall bed doors. Please use handles in order to have more anchor points into the door panel and avoid injuries that may be caused by the knobs detaching from the door panels. Install handles according to manufacturer's instructions.

## NOTICE

Do not mount handle lower than approximately 1/3 of the way down from the top of the door as this could result in the door being harder to open.

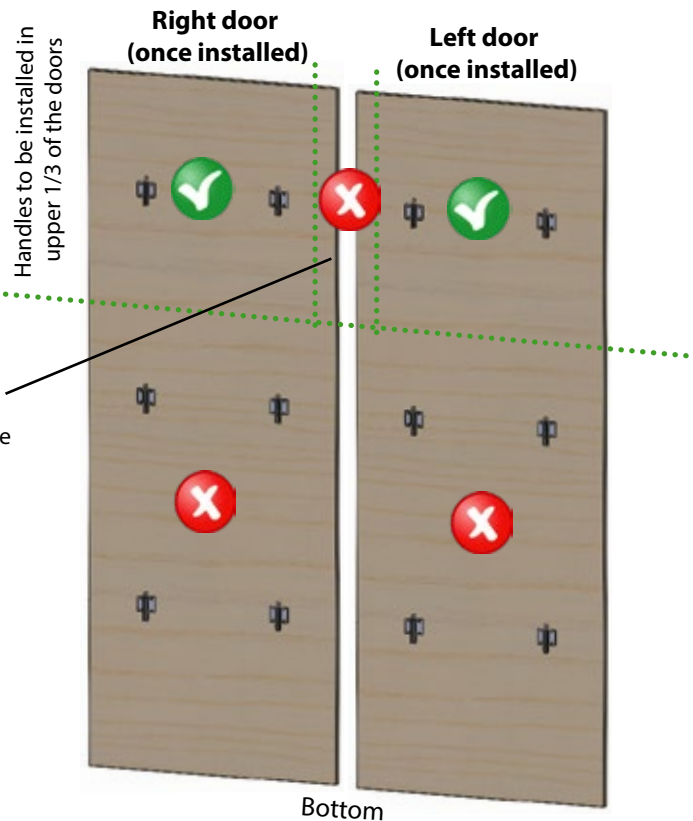

# 9

## VALIDATING THE DOOR & BRACKET PLACEMENT

With the help of another person, hook on 1 door to validate the depth placement of the door. See graphics below for expected results.

See next step for how to adjust according to the results.



For this step X 2



The door is too much inside of the wall bed cabinet.

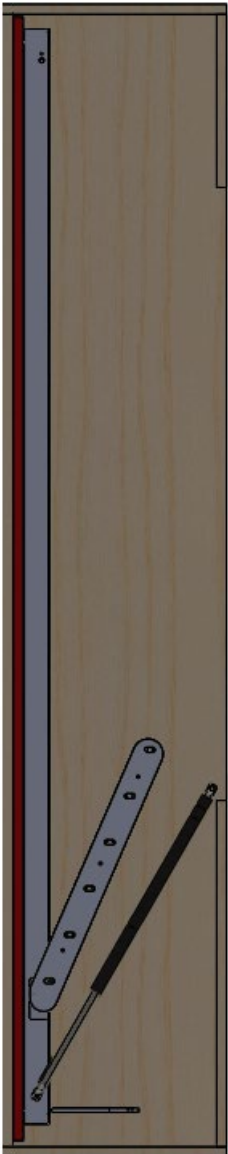

The door is flush to the wall bed cabinet.

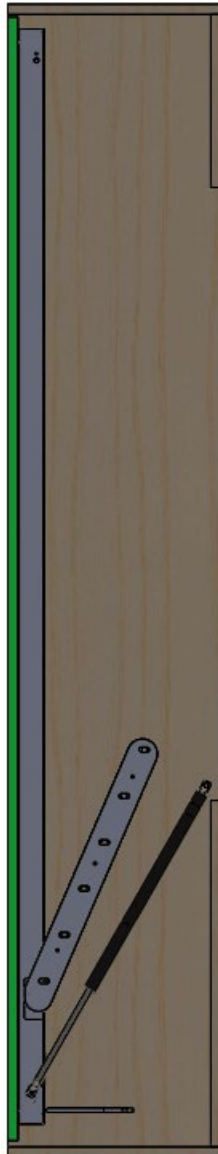

The door is too much outside of the wall bed cabinet.



### DANGER

Do NOT let go of the door or frame, the pistons are not fully installed yet and it will freefall which could result in injury or death.



#### TIP-OVER HAZARD

Serious or fatal crushing injuries can occur from furniture tip-over. To prevent, furniture MUST be permanently fixed to the wall.

# 10 VALIDATING THE DOOR & BRACKET PLACEMENT

With the help of another person, lightly loosen the **N** screws installed on step 1 and reposition the brackets by shifting lightly towards the back of the front to get a door that is aligned with the cabinet.

**S**  x 6

Once the door is aligned, tighten the **N** screws and add the **S** wood screws.

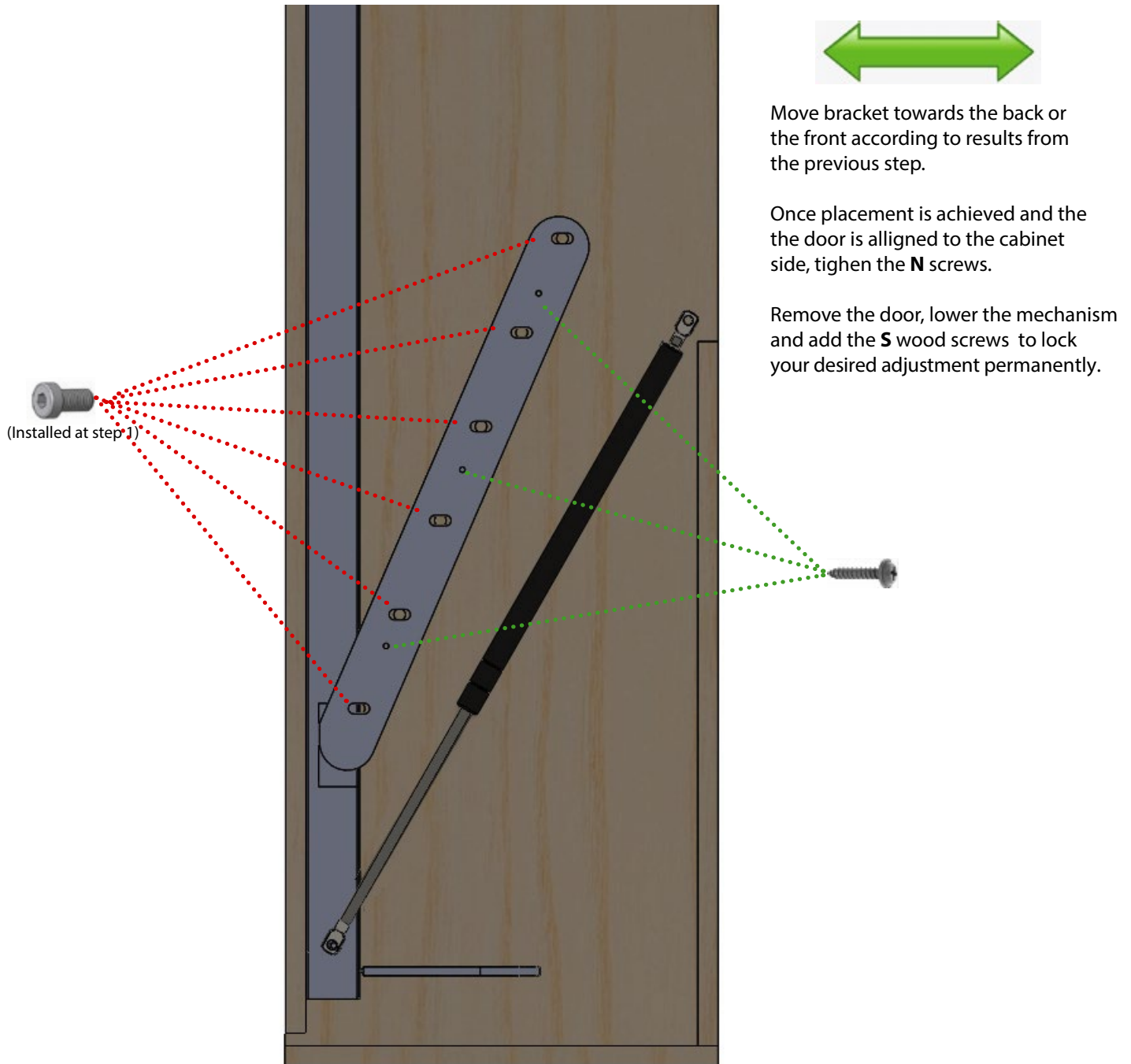

# 11 INSTALLING THE PISTONS TO THE CABINET



Tilt the frame inside past the edge of the cabinet to install the pistons on the mounting brackets.

## **⚠ DANGER**

The pistons are now installed, therefore, do NOT operate the bed without the help of another person. Do NOT let go of the mechanism. If you let go, the bed frame WILL snap up suddenly and could cause serious injury or death.

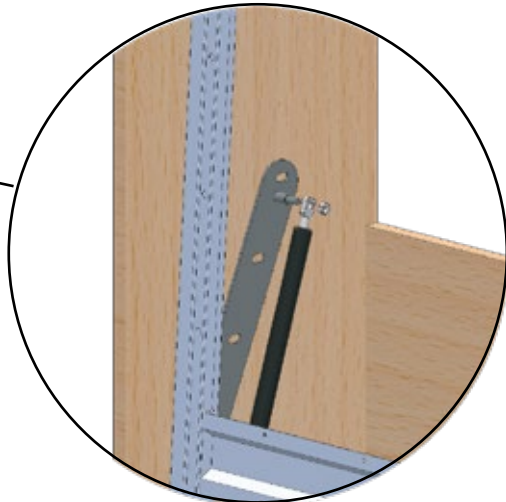

V  x2

\* Please make sure that the nuts are fully tightened to prevent loosening when operating the wall bed mechanism.

# 12 INSTALLING THE STOPPER

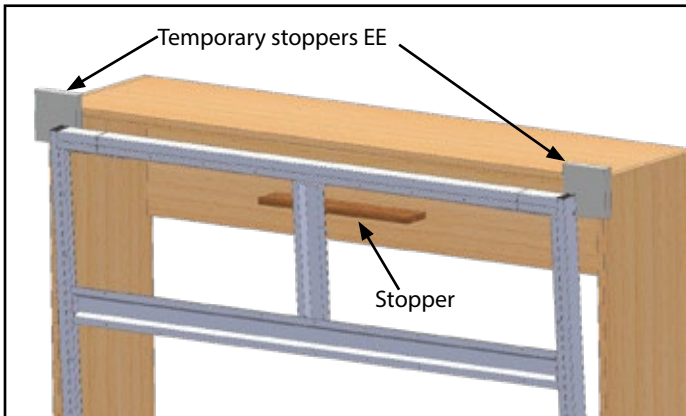

Install temporary stoppers **EE** onto the top corners of the bed cabinet.

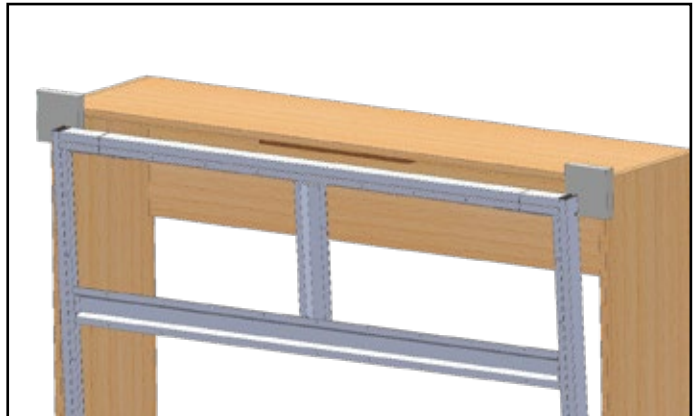

Install the permanent stopper on the inside top of the cabinet where it will allow for the door to close flush to the front of the cabinet.

\*Permanent stopper should be set back from the cabinet edge by the same thickness as the door used.

# 13 INSTALLING THE LEGS

## 13.1

With bed closed on temporary stoppers, attach legs to bed frame with **V**. Do not over tighten.

**V**=  x2

**=**  x4

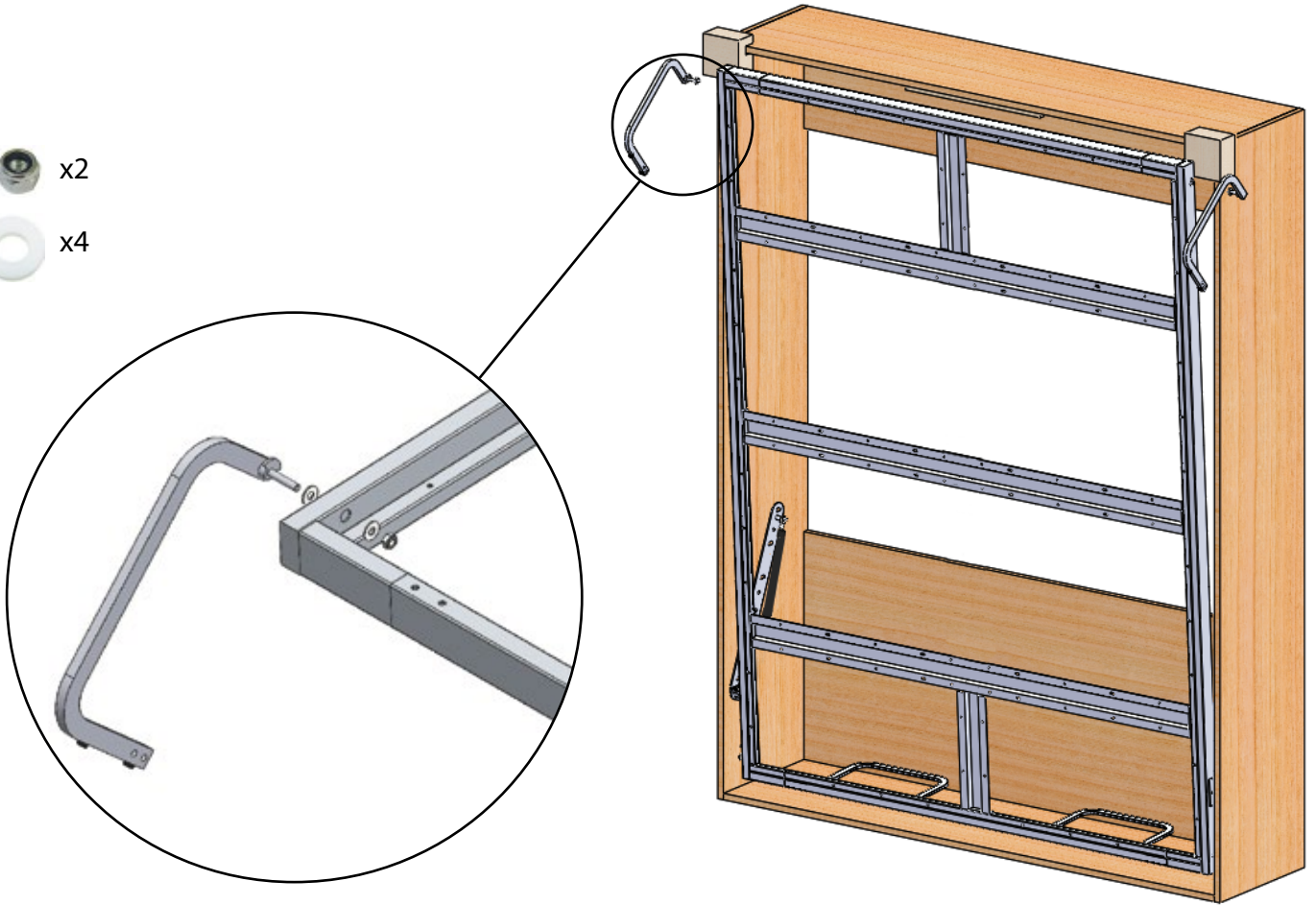

## 13.2

Install tube between both legs.

**I**=  x4

**P**= 

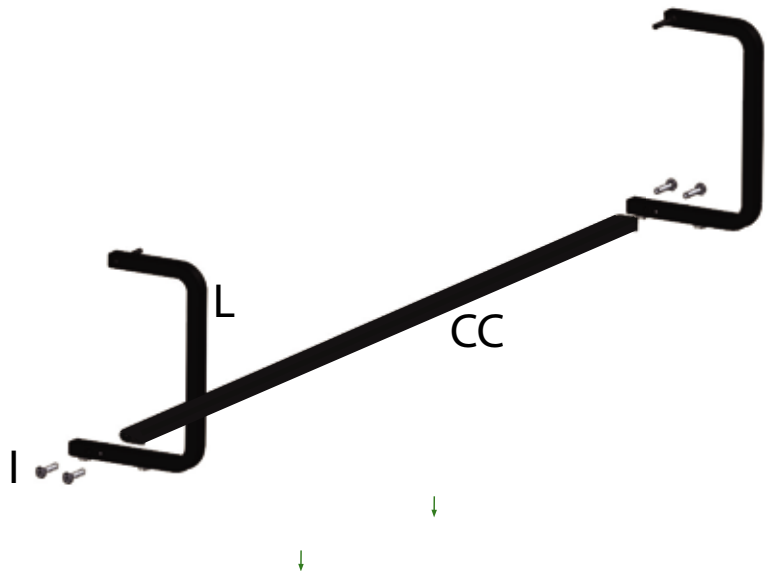



# 14 INSTALLING THE DOORS

## 14.1

Close the bed back onto the temporary stoppers **EE**. Hook the door brackets onto the frame and push down until they are firmly in place. Center the doors on the frame and adjust with bracket screws if needed.

Once the doors are hooked on, if necessary, you can adjust the angles and height of each door with bracket "K". Adjust each bracket until:

- the doors open and close well;
- have an even gap on each side;
- doors are lined up with the cabinet.

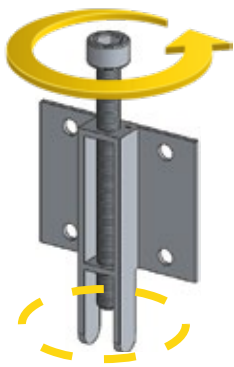

Turn the screw counter clockwise = Door will go down to loosen



Turn the screw clockwise = Door will go up to tighten

### **⚠ DANGER**

The pistons are now installed, therefore, the bed will **NOT** stay down without the weight of the mattress. You **MUST** have another person hold down or sit on the bed to avoid the risk of serious injury or death from the bed slamming shut.

Note that ends are rounded so that doors can slide left - right for a better adjustment.



## 14.2

Attach the doors to the frame with all of the screws provided (multiple holes in frame available) while putting weight on the frame to keep the bed open. We recommend to have someone else sit on the frame during this step.

For this step x 2



### **⚠ DANGER**

The pistons are now installed, therefore, the bed will **NOT** stay down without the weight of the mattress. You **MUST** have another person hold down or sit on the bed to avoid the risk of serious injury or death from the bed slamming shut.

S  x 72

R  x 32

NOTE: The use of a foam/very light mattress is NOT recommended for this product.

Screw "S" is for inner braces.

Screw "R" is for outer tube.

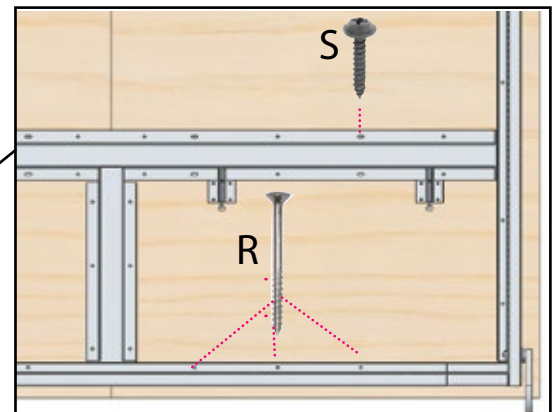
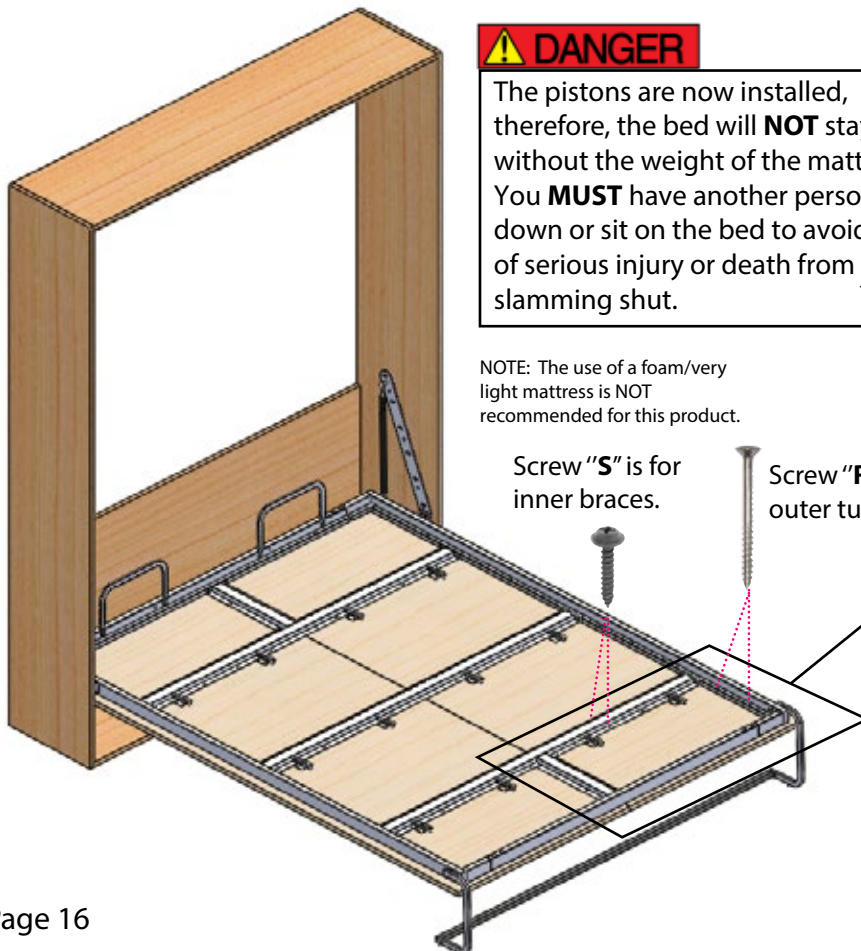

# 15

## INSTALLING REMAINING FRAME SUPPORTS

For this step x 2 

S  x 16

E  x 2

Attach the two remaining frame supports to the doors. Keep weight on the frame during this step.

### DANGER

The pistons are now installed, therefore, the bed will **NOT** stay down without the weight of the mattress. You **MUST** have another person hold down or sit on the bed to avoid the risk of serious injury or death from the bed slamming shut.

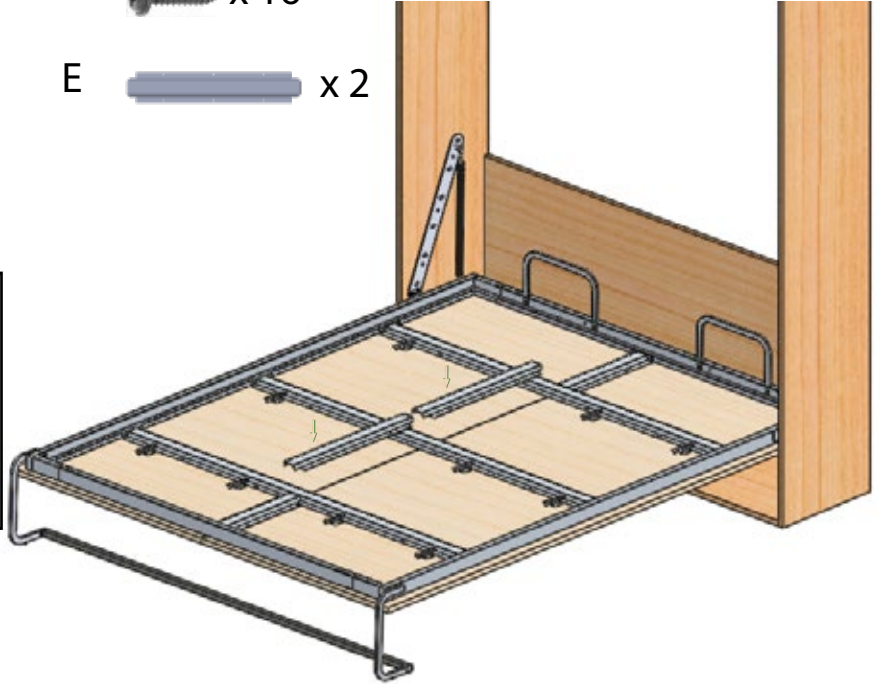

# 16

## INSTALLING THE MECHANISM COVER (OPTIONAL ACCESSORY PURCHASED SEPARATELY)

Lower the inner curve of the FF bracket onto the mounting plate F and line up the angled side. Secure in place with wood screws Y. Slide on the mechanism cover GG and secure in place with the little set screw in the back.

Y  x20

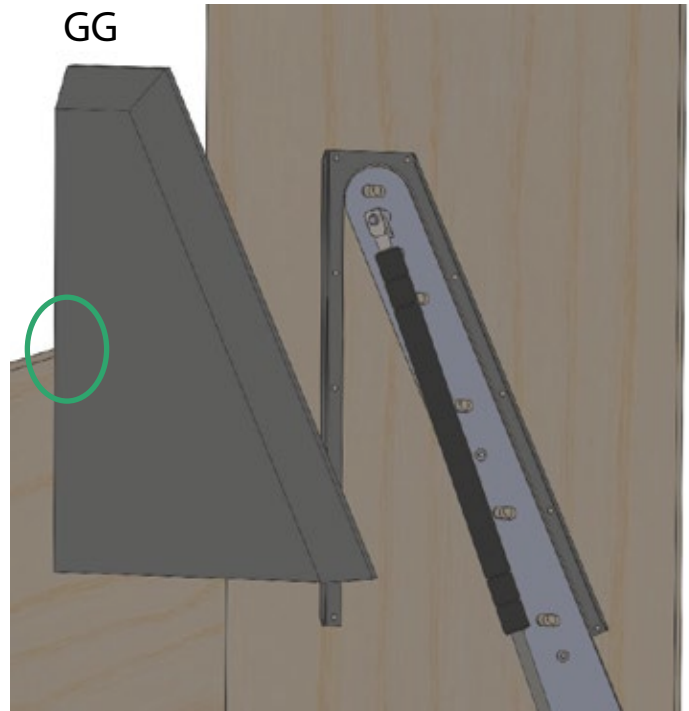
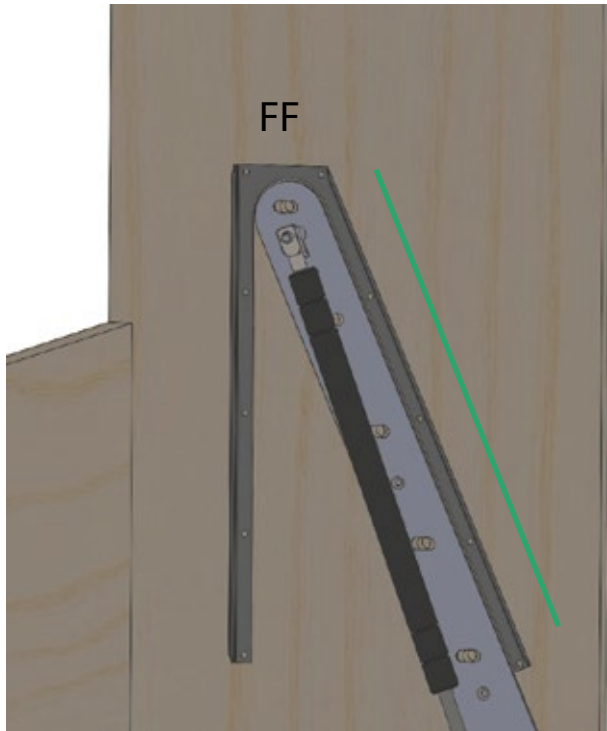

# Did you purchase the comfort slat option?

If **yes**, please refer to the instructions included in the comfort slat kit.

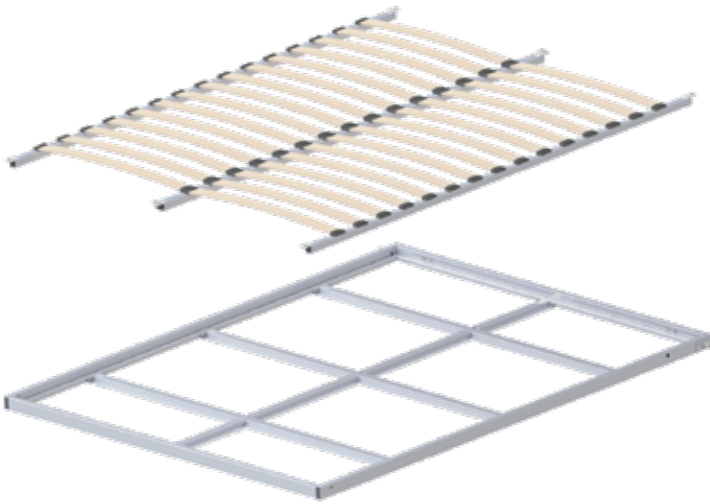

Optional 5-ply poplar slats to support the mattress:

- Easy to install;
- Can be purchased later on;
- Added comfort;
- Extends the life of the mattress;
- Improves air flow around the mattress.
- hypoallergenic

## Did you know? You can also use a plywood option.

It is possible to use the mechanism without anything between the mattress and the mechanism depending on the mattress that will be used. Please validate any questions you may have regarding your mattress to the mattress manufacturer.

Use 10mm (3/8") or 12.5mm (1/2") plywood. Cut the sheet 6mm (1/4") smaller than the inside of the frame. For the mechanism to function in an optimal manner, the panel should have a weight of approximately 30-35lbs.

Secure in place using the holes on the lower tube of the outside frame. Use screws in accordance to the thickness you are using to avoid damage to the doors.

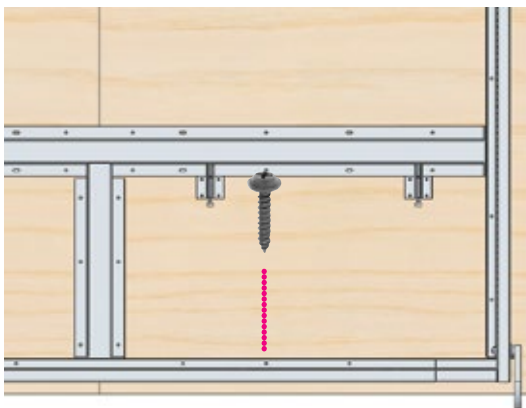

See next page for dimensions.

RECOMMENDED DIMENSIONS FOR PLYWOOD OPTION ON DOUBLE/FULL VERTICAL WALL BED

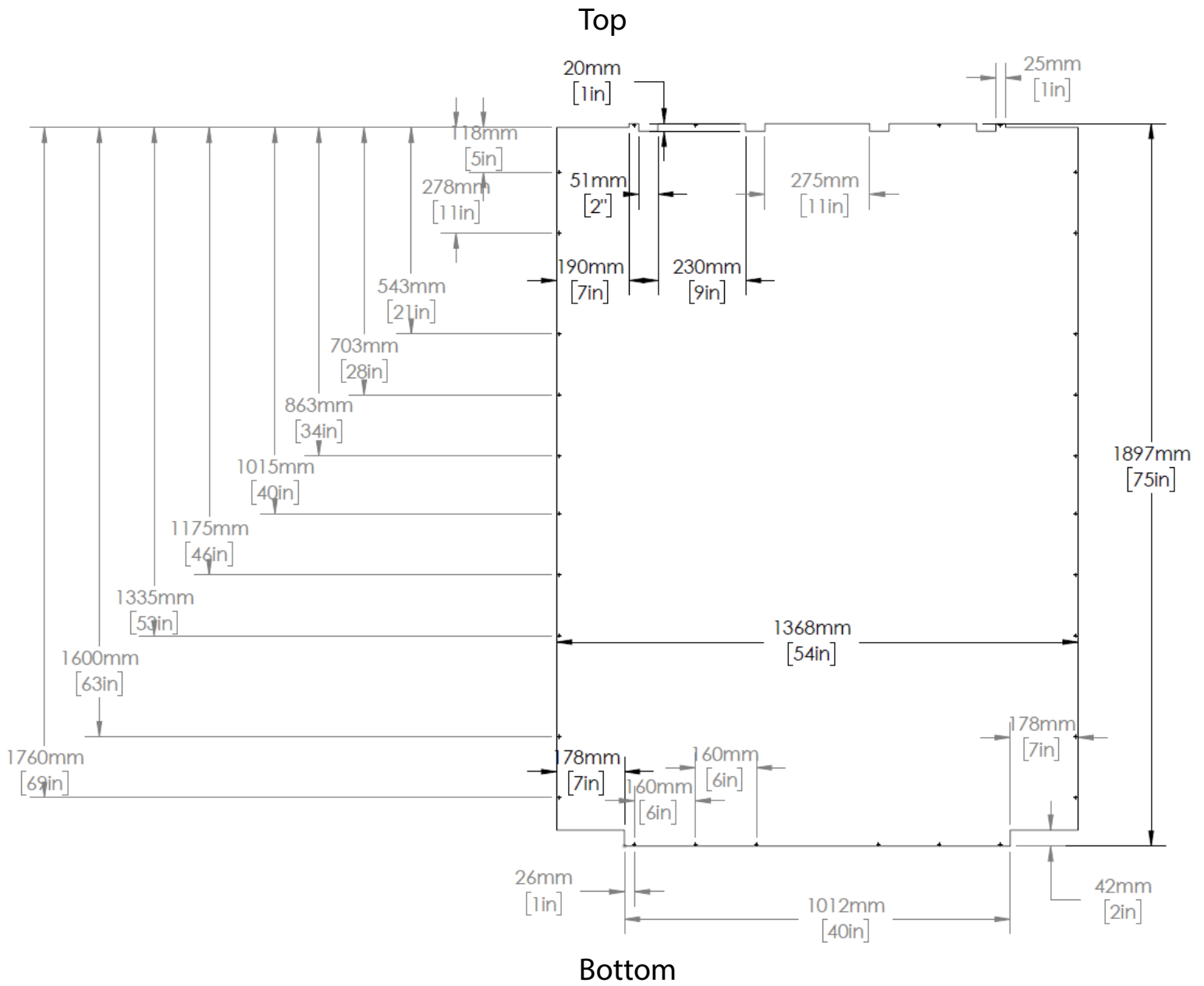

## USING THE WALL BED

1



The wall bed is assembled and shown in lowered position.

2



Pivot the leg towards the inside of the unit. Make sure that the leg is fully retracted.

3



Pull up gently to close. The leg serves as a mattress retaining system. The pistons insure that the door closes properly and remains closed.



Before operating the wall bed, ensure that no object or people are in the way to avoid injuries or damages.

### DANGER

The pistons are now installed, therefore, the bed will **NOT** stay down without the weight of the mattress. You **MUST** have another person hold down or sit on the bed to avoid the risk of serious injury or death from the bed slamming shut.