

PRODUCT DATA SHEET

Product Description: Door bumper, universal, 2" high. Fabricated from zinc with a US15 satin nickel finish. Single mounting screw included.

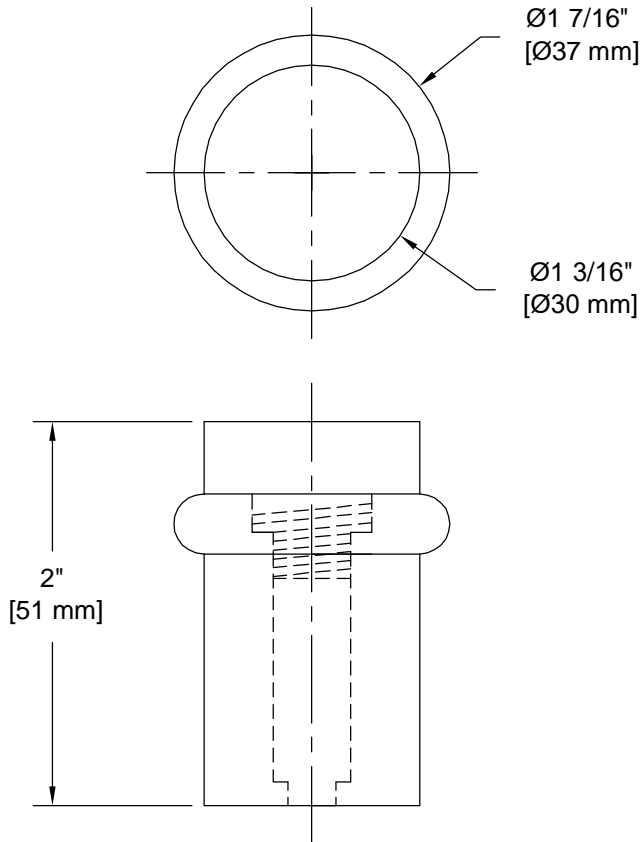

Overall Size: 1 7/16" W X 2" H X 1 7/16" D

Material: Zinc

Finish: US15 Satin Nickel

Cross Reference

Manufacturer	Part Number



Description:

**Door Bumper, Zinc,
Universal, 2" High**

Part Number:

UFB5000U15

Date

09/19

Rev.

05

Sheet 1 of 1