

SilentCall[®]
Communications

MEDALLION
SERIES

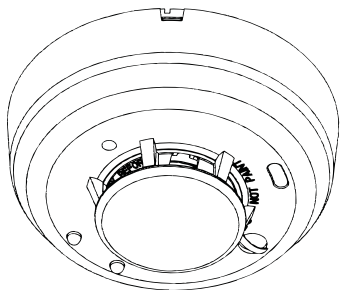

PHOTOELECTRONIC SMOKE DETECTOR WITH BUILT-IN WIRELESS TRANSMITTER

Installation and Operation Manual

INTERTEK
ETL^{CM}
LISTED US
3126052

Model # SD4-MC(US)
418 MHz TRANSMITTER

Document #
108137

General Information

Before installing detectors, please thoroughly read these installation instructions. For detailed information on detector spacing, placement, zoning, wiring, and special applications refer to current edition of the NFPA 72 National Fire Alarm Signaling Code.

NOTICE: Do not discard this manual. Manual should be left with the owner/user of this equipment.

IMPORTANT: This detector must be tested and maintained regularly following NFPA requirements. Test detector operation weekly. The detector should be cleaned at least once a year.

NOTE: Smoke Detectors have a limited life. Smoke detectors should be replaced immediately if not operating properly. You should always replace a smoke detector after 10 years from date of purchase.

NOTE: Remove battery tab before installation.

NOTE: Radio Frequency device operates at 418MHz

General Description:

The Model SD4-MC(US) photocell electronic smoke detector with built-in wireless transmitter is intended for use with the Silent Call® Mini receiver to form an alerting system. The transmitter will send alarm condition messages to the system's receiver.

The SD4-MC(US) wireless transmitter operation is to be used only with Silent Call® Medallion Series Receivers. The transmitted signal incorporates a Million Code Address principle that provides each SD4-MC(US) detector with a unique one in a million address. This helps to keep any cross talk between like transmitters in a typical single living, multi-dwelling, or apartment building to a minimum where it is possible to have adjacent apartments with Medallion Series Receivers.

IMPORTANT: The range and proper operation of any wireless device will vary depending on its surroundings. It is very important that each SD4-MC(US) detector is tested with each receiver intended for Alarm.

The Model SD4-MC(US) incorporates a state of the art optical sensing chamber and an advanced microprocessor. The microprocessor allows the detector to automatically maintain proper operation at factory calibrated detection levels, even when sensitivity is altered due to the presence of contaminants settling into the unit's smoke chamber. In order for this feature to work properly, the chamber must never be opened while power is applied to the smoke detector.

This includes cleaning, maintenance or screen replacement.

The Model SD4-MC(US) contains a piezoelectric horn which generates the ANSI S3.41 temporal pattern in an alarm condition. During an alarm condition, pressing the detector's test switch will silence the piezoelectric horn for 5 minutes. The built-in Drift Compensation algorithm automatically maintains the sensitivity of the detector. The mounting base installation is simplified by the incorporation of features compatible with drywall fasteners or other methods that provide a method for securing the detector in place.

Current studies have shown smoke detectors may not awaken all sleeping individuals, and that it is the responsibility of individuals in the household that are capable of assisting others to provide assistance to those who may not be awakened by the alarm sound, or those who may be incapable of safely evacuating the area unassisted.

Two LEDs and a sounder on the detector provide local visual and audible indication of the detector's status:

Table 1: Detector LED Modes

	Green LED	Red LED	Piezoelectric Horn
Power-up	Blinks every 5 sec	Blinks every 5 sec	Off
Normal (Standby)	Blinks every 10 sec	Off	Off
Out of Sensitivity	Off	Blinks every 5 sec	Off
Smoke Alarm	Off	Blinks every 1 sec	Temporal Pattern
Low Battery	Off	Blinks every 45 sec	Chirp every 45 sec after LED blinks for 7 days

During initial power-up, the red and green LEDs will blink synchronously once every 5 seconds. It will take approximately 20 seconds for the detector to finish the power-up cycle (see Table 1).

After the power-up cycle has been completed and the detector is

functioning normally within its listed sensitivity range, the green LED blinks once every 10 seconds. If the detector is in need of maintenance because its sensitivity has shifted outside the listed limits, the red LED blinks once every 5 seconds. When the alarm has been activated by smoke, the red LED blinks every 1 second. The LED indication must not be used in place of the tests specified under Testing. If the detector senses a low battery condition, the red LED blinks once every 45 seconds.

Low Battery Detection:

The Model SD4-MC(US) is powered by a single 3-volt CR123A Lithium battery. The detector checks for a low battery at least every 65 minutes. In addition, the red LED of the Model SD4-MC(US) will blink every 45 seconds and the test switch will be disabled. This condition will exist for a minimum of 7 days, and then the detector's horn will "chirp" about every 45 seconds. Pressing the test switch during this time will silence the chirps for 12 hours. The battery should be replaced BEFORE the chirps begin. Be sure to replace the battery with a fresh one. **Batteries can be purchased directly from Silent Call Communications by calling 1-800-572-5227, or online at www.silentcall.com.**

Battery Life Expectancy:

Replace the battery once a year or immediately when the low battery indicator starts to blink and the horn begins to chirp.

Battery Installation and Replacement:

To replace the battery:

1. Remove the detector from its mounting base by twisting the detector counterclockwise. Remove the battery and dispose of it properly.
2. To ensure proper power-down sequence, wait a minimum of 20 seconds before installing new battery.
3. Install a new approved 3-volt Lithium battery in the battery compartment. Follow the polarity diagram inside the compartment.
4. Reinstall the smoke detector onto the mounting base by turning the detector clockwise.
5. The green LED should blink about once every 10 seconds to indicate normal operation. If the battery is not installed correctly, the smoke detector will not operate and the battery may be damaged. If the detector does not appear to be sending a signal during any of the tests, check for correct battery installation and for a fully charged battery.
6. Test Smoke detector operation with Medallion Series Receiver to verify proper operation.

NFPA Required Protection:

This smoke detector should be installed in accordance with the National Fire Protection Association, Standard 72 (National Fire Protection Association, Quincy, MA 002269). This detector will provide maximum protection when installed in compliance with the National Fire Protection Association (NFPA). Standard NFPA 72, household fire warning equipment

“For your information, the National Fire Alarm and Signaling Code NFPA reads as follows”

11.5.1* Required Detection

Where required by applicable laws, codes, or standards for a specific type of occupancy, approved single and multiple-station smoke alarms shall be installed as follows:

1. *In all Sleeping Rooms and Quest Rooms.
2. *Outside of each separate dwelling unit sleeping area, within 6.4 m (21 ft) of any door to a sleeping room, with the distance measured along a path of travel.
3. On every level of a dwelling unit, including basements.
4. On every level of a residential board and care occupancy (small facility), including basements and excluding crawl spaces and unfinished attics.
5. *In living area(s) of a guest suite.
6. In the living area(s) of a residential board and care occupancy (small facility).

(Reprinted with permission from NFPA 72®[®], National Fire Alarm Code Copyright© 2007 National Fire Protection Association, Quincy MA 02269. This reprinted material is not the complete and official position of the Nation Fire Protection Association, on the referenced subject which is represented only by the standard in its entirety.)
(National Fire Alarm Code®[®] and NFPA 72®[®] are registered trademarks of the National Fire Protection Association, Inc., Quincy, MA 02269.)

Recommended Locations for Smoke Detectors:

The National Fire Protection Agency (NFPA) recommends one smoke detector on every floor, in every sleeping area, and in every bedroom. In new construction, the smoke detectors must be AC powered and interconnected. For additional coverage, it is recommended that you install a smoke detector in all rooms, halls, storage areas, finished attics, and basements where temperatures normally remain between 4.4°C to 37.8°C. Make sure no door or other obstruction could keep smoke from reaching detectors.

Specifically locate detectors:

- On every level of your residence, including basements and finished attics.
- Inside every Bedroom, especially if people sleep with the doors closed.
- Inside every bedroom where electrical appliances (such as portable heaters or humidifiers) are operated where someone sleeps.
- At the bottom of the basement stairwell.
- At the top of the first-to-second floor stairwell, as long as no other door or other obstructions block the path of smoke to the detector
- As close to the center of the ceiling as possible. If this is not practical, put the detector on the ceiling, but no closer than 4 inches (10 cm) from any wall or corner. See figure 1.
- If wall mounting is permitted by your local and state codes. Put the top of wall-mounted detectors between 4 and 6 inches (10 and 15

- cm) from the ceiling. see figure 1.
- Put a smoke detector at both ends of a bedroom hallway if the hallway is more than 40 feet (12 meters) long.

PLACE ONE SMOKE ALARM ON EVERY FLOOR AND SLEEP ROOM

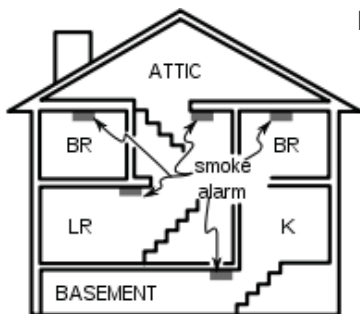
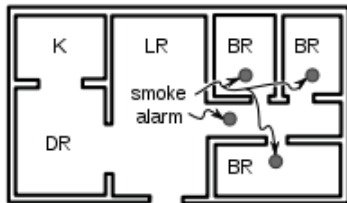

Figure 1: Recommended locations for smoke alarms

MULTI-STORY



SINGLE LEVEL

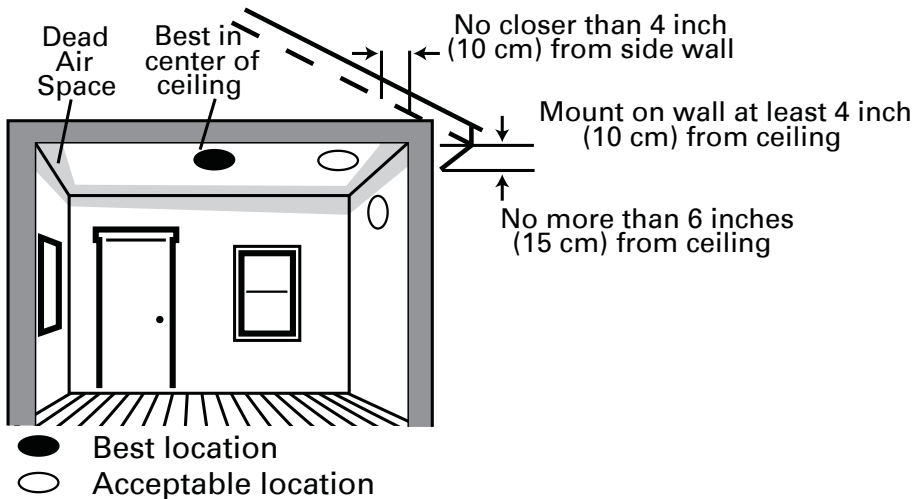

Figure 1.2: Recommended smoke detector mounting locations.

- In rooms with sloped, peaked, or gabled ceilings, mount detectors within 3 feet (0.9 meters) measured horizontally from the highest point of the ceiling. See figure 2.

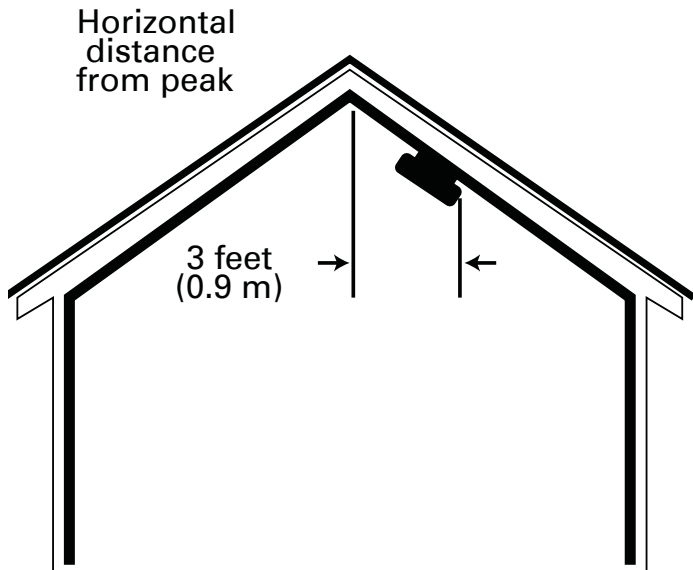

Figure 2: Recommended smoke detector location in rooms with sloped, gabled, or peaked ceilings.

Where Smoke Detectors Should Not Be Located:

Nuisance alarms are caused by placing detectors where they will not operate properly. To avoid nuisance alarms, do not place detectors:

- In or near areas where combustion particles are normally present such as kitchens, in garages where there are particles of combustion from vehicle exhausts, near furnaces, hot water heaters, or gas space heaters. Install detectors at least 20 feet (6 meters) away from kitchens and any other areas where combustion particles are normally present.
- In air streams passing by kitchens. Figure 3 shows how a detector can be exposed to combustion particles in normal air movement paths, and how to correct this situation.

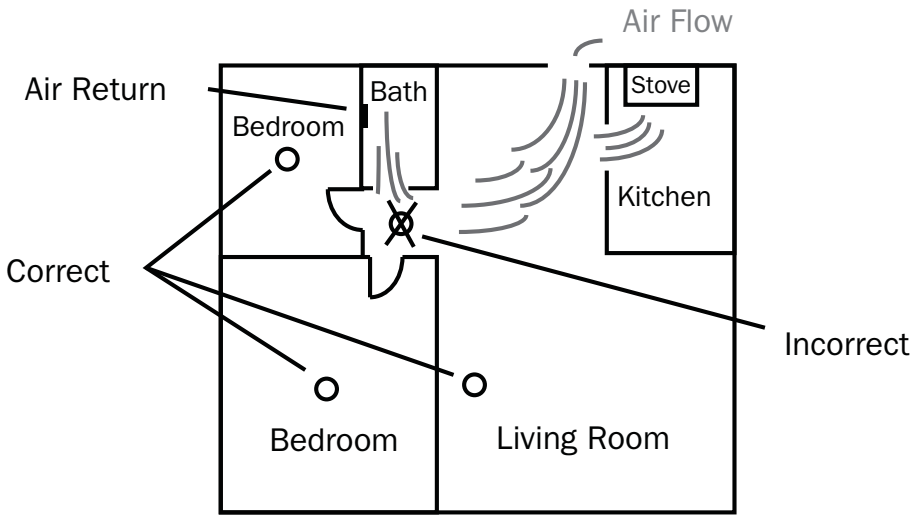

Figure 3: Recommended smoke detector locations to avoid air streams with combustion particles.

- In damp or very humid areas, or next to bathrooms with showers. The moisture in humid air can enter the sensing chamber as water vapor, and will cool and condense into droplets that cause a nuisance alarm. Install detectors at least 5 feet (1.5 meters) away from bathrooms.
- In very dusty or dirty areas. Dust and dirt can build up on the detector sensing chamber and make it overly sensitive, or can block openings to the sensing chamber and keep the detector from sensing smoke.
- Near fresh air inlets or returns or excessively drafty areas. Air conditioners, heaters, fans, and fresh air intakes and returns can drive smoke away from smoke detectors, making the detectors less effective.
- In dead air spaces at the top of a peaked roof or in the corners between ceilings and walls. Dead air may prevent smoke from reaching the detector. See figures 4 and 5 for recommended mounting location.
- In insect-infested areas. If insects enter a detector's sensing chamber they may cause a nuisance alarm. Get rid of the bugs before installing detectors where bugs are a problem.

- Near florescent light fixtures. Electrical “noise” from nearby florescent light fixtures may cause a nuisance alarm. Install detectors at least 10 feet (3 meters) away from such light fixtures.

Limitations of Smoke Alarms

- Smoke detectors will not work without power. Battery operated detectors will not work without batteries, with dead batteries, or if the batteries are not put in properly. AC-powered detectors will not work if their AC power supply is cut off by an electrical fire, and open fuse or circuit breaker, or for any other reason. If you are concerned about the reliability of either batteries or your AC power supply for any of the above reasons, you should install both battery powered and AC powered detectors for maximum safety.
- Smoke detectors must be tested regularly to make sure the batteries and the alarm circuits are in good operating condition.
- Smoke detectors may not sense fires that start where smoke cannot reach the detectors such as in chimneys, in walls, on roofs, or on the other side of closed doors. If bedroom doors are usually closed at night, detectors should be placed in each bedroom as well as in the common hallway between them.
- Smoke detectors also may not sense a fire on another level of the residence or building. For example, a second-floor detector may not sense a first-floor or basement fire. Therefore, detectors should be placed on every level of a residence or building.

- The horn in your detector meets or exceeds current audibility requirements of Underwriters Laboratories. However, if the detector is located outside a bedroom, it may not wake a sound sleeper, especially if the bedroom door is closed or only partly open. If the detector is located on a different level of the residence than the bedrooms, it is even less likely to wake up people sleeping in the bedrooms.
- All types of smoke detectors have limitations. No type of smoke detector can sense every kind of fire every time. In general, detectors may not always warn you about fires caused by carelessness and safety hazards like smoking in bed, violent explosions, escaping gas, improper storage of flammable materials, overloaded electrical circuits, children playing with matches or arson.
- Installing smoke detectors may make you eligible for lower insurance rates, but smoke detectors are not a substitute for insurance. Homeowners and renters should continue to insure their lives and property.

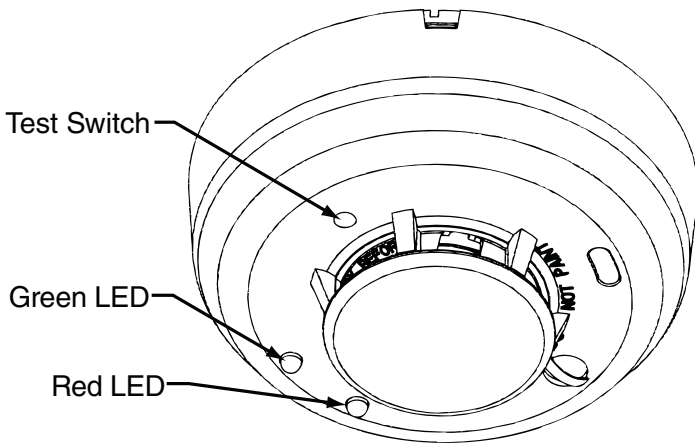

Figure 4: Silent Call Model #SD4-MC(US) Wireless Smoke Detector

Programming

The smoke detector is pre-programmed at the factory.

Transmitter Setting

The Silent Call® system is digitally coded. The Medallion Series SD4-MC(US) Smoke Detector is set to a unique million code setting at the factory and therefore never requires the need of a different code.

Transmitter operates at a frequency of 418MHz.

Mounting

First, determine the best location for the smoke detector, one that provides a strong wireless transmission path and proper smoke detection. A GOOD TRANSMISSION PATH MUST BE ESTABLISHED FROM THE PROPOSED MOUNTING LOCATION BEFORE PERMANENTLY INSTALLING THE DETECTOR. To check, perform the test described in the TESTING SIGNAL STRENGTH section of this manual. To mount the detector, perform the following steps:

1. Once a suitable location has been determined, install the mounting base on the ceiling or on the wall (if local ordinances permit). Use the two screws and anchors provided.
2. Turn the detector in a clockwise direction in the mounting base until it clicks into place.
3. ***Test the detector immediately after completing the installation as described in the TESTING section of this manual.***

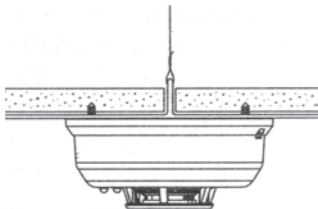

Figure 5: Mount Detector Across Ceiling Panel Support.



DO NOT attach the detector to removable ceiling panels. Attach the detector across panel support as shown in Figure 5.

Dust Covers are an effective way to limit the entry of dust into the smoke detector sensing chamber during construction. However, they may not completely prevent airborne dust particles from entering the detector. Therefore, it is recommended that the detectors be removed before beginning construction or other dust producing activity. When returning the system to service, be sure to remove the dust covers from any detectors that were left in place during construction.

Smoke detectors are not to be used with detector guards unless the combination has been evaluated and found suitable for that purpose.

Testing the Sensor

Detectors must be tested after installation and following periodic maintenance. The Model #SD4-MC(US) may be tested as follows:

A. Test Switch

1. A recessed test switch is located on the detector housing (see Figure 6).
2. Push and hold the recessed test switch for a minimum of 5 seconds. Use a small screwdriver or Allen key with maximum diameter of 0.18 inch (the detector will trigger and then the smoke detector will go into alarm thus sending a transmitting signal to the receiver. If the tool is removed from the recessed switch the sounder will shut off)

If the detector is within the listed sensitivity limits, the LED on the detector should blink once per second and the horn should sound within 3 seconds.

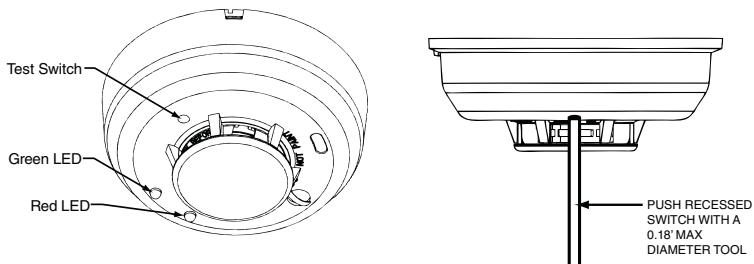

Figure 6: Recessed Test Switch Opening

B. Smoke Entry Test

Hold a smoldering punk stick or cotton wick at the side of the detector and gently blow smoke through the detector until the unit alarms. Canned aerosol is also an accepted method.

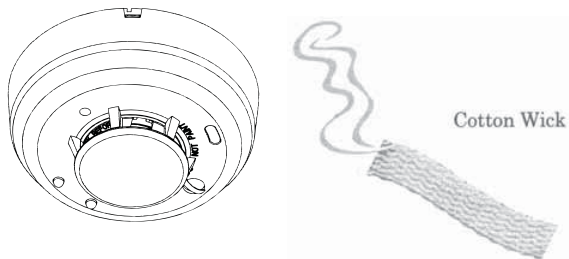

Figure 7: Testing with Wick

Testing Signal Strength

A test should be performed before installation to determine a strong communication path with the receiver and after installation is complete. Also the owner/user should test the unit at least weekly.

Testing Programming

A test should be performed before installation to ensure the detector transmitter address is properly programmed to the receiver, and are operational as a system.

Maintenance

NOTE: Power must be removed from the detector before performing maintenance of any kind by removing the detector's battery.

1. To ensure proper power-down sequence, battery must be removed from detector for a minimum of 20 seconds before servicing.
2. Vacuum the cover or use canned air to remove any dust or debris.
3. Using a vacuum or canned air spray carefully clean any dust or debris From Smoke Detector Cover.
4. Reinstall the detector and test. (see the Testing section).

What to do in case of fire

- Don't panic; stay calm. Follow your family escape plan.
- Get of the house as quickly as possible. Don't stop to get dressed or collect anything.
- Feel doors with the back of your hand prior to opening them. If a door is cool, open it slowly. Don't open a hot door. Keep door and windows closed, unless you must escape through them.
- Cover your nose and mouth with a cloth (preferably damp). Take short shallow breaths.
- Meet at the planned meeting place outside your home, and take a head count to make sure everybody got out safely.
- Call the fire department from outside. Give your address, then your name.
- Never go back inside a burning building for any reason.
- Contact your fire department for suggestions and ideas on how to make your home safer.

FCC INFORMATION NOTICE:

Unauthorized changes or modifications could void the user's authority to operate the equipment.

This device complies with Part 15 of the FCC Rules. Operation is subject to the following two conditions: (1) This device may not cause harmful interference, and (2) this device must accept any interference received, including interference that may cause undesired operation of the device.

This equipment has been tested and found to comply with the limits for a Class B digital device, pursuant to Part 15 of FCC Rules. These limits are designed to provide reasonable protection against harmful interference in a residential installation. This equipment generates, uses and can radiate radio frequency energy and if not installed and used in accordance with the instructions, may cause harmful interference to radio communications. However, there is no guarantee that interference will not occur in a particular installation. If this equipment does cause harmful interference to radio or television reception, which can be determined by turning the equipment off and on, the user is encouraged to try to correct the interference by one or more of the following measures:

- Reorient or relocate the receiving antenna.
- Increase the separation between the equipment and the receiver
- Connect the equipment into an outlet on a circuit different from that to which the receiver is connected.
- Consult the dealer or an experienced radio/television technician for help

Specifications

Power Source:	One 3-volt CR123A Lithium Battery (included). (Replace with Panasonic CR123A or DURACELL DL123A) These batteries are available at local retail stores. You can also order Replacement Batteries Online at www.Silentcall.com .
Height:	2.3 inches (58 mm)
Diameter:	5.3 inches (135 mm) (with mounting base)
Weight:	8.5 oz. (241 g) (without battery)
Operating Ambient Temperature Range:	40° to 100°F (4.4° to 37.8°C)
Operating Humidity Range:	0% to 95% Relative Humidity
Agency Listings:	Conforms to UL STD 217

For Warranty Claims/Repairs Please Contact the Manufacturer:

Silent Call Communications
5095 Williams Lake Road
Waterford, MI 48329
800-572-5227

Please Visit www.Silentcall.com

The logo for Silent Call Communications features the brand name in a bold, sans-serif font. A curved line arches over the word "Call". Below the brand name, the word "Communications" is written in a smaller, lighter font.

SilentCall
Communications

MEDALLION
SERIES