



**Desktop Speakerphone  
with Amplified Volume  
and Tone Control  
User's Guide**

Please read this manual before operating  
product for the first time.

Visit the RCA web site at [www.rca4phones.com](http://www.rca4phones.com)

**Model 1123**

# Equipment Approval Information

---

Your telephone equipment is approved for connection to the Public Switched Telephone Network and is in compliance with parts 15 and 68, FCC Rules and Regulations and the Technical Requirements for Telephone Terminal Equipment published by ACTA.

## 1 Notification to the Local Telephone Company

On the bottom of this equipment is a label indicating, among other information, the US number and Ringer Equivalence Number (REN) for the equipment. You must, upon request, provide this information to your telephone company.

The REN is useful in determining the number of devices you may connect to your telephone line and still have all of these devices ring when your telephone number is called. In most (but not all) areas, the sum of the RENs of all devices connected to one line should not exceed 5. To be certain of the number of devices you may connect to your line as determined by the REN, you should contact your local telephone company.

A plug and jack used to connect this equipment to the premises wiring and telephone network must comply with the applicable FCC Part 68 rules and requirements adopted by the ACTA. A compliant telephone cord and modular plug is provided with this product. It is designed to be connected to a compatible modular jack that is also compliant. See installation instructions for details.

## Notes

- This equipment may not be used on coin service provided by the telephone company.
- Party lines are subject to state tariffs, and therefore, you may not be able to use your own telephone equipment if you are on a party line. Check with your local telephone company.
- Notice must be given to the telephone company upon permanent disconnection of your telephone from your line.
- If your home has specially wired alarm equipment connected to the telephone line, ensure the installation of this product does not disable your alarm equipment. If you have questions about what will disable alarm equipment, consult your telephone company or a qualified installer.

**US Number is located on the cabinet bottom.**

**REN Number is located on the cabinet bottom.**

## 2 Rights of the Telephone Company

Should your equipment cause trouble on your line which may harm the telephone network, the telephone company shall, where practicable, notify you that temporary discontinuance of service may be required. Where prior notice is not practicable and the circumstances warrant such action, the telephone company may temporarily discontinue service immediately. In case of such temporary discontinuance, the telephone company must: (1) promptly notify you of such temporary discontinuance;

(2) afford you the opportunity to correct the situation; and (3) inform you of your right to bring a complaint to the Commission pursuant to procedures set forth in Subpart E of Part 68, FCC Rules and Regulations.

The telephone company may make changes in its communications facilities, equipment, operations or procedures where such action is required in the operation of its business and not inconsistent with FCC Rules and Regulations. If these changes are expected to affect the use or performance of your telephone equipment, the telephone company must give you adequate notice, in writing, to allow you to maintain uninterrupted service.

## **Interference Information**

---

This device complies with Part 15 of the FCC Rules. Operation is subject to the following two conditions: (1) This device may not cause harmful interference; and (2) This device must accept any interference received, including interference that may cause undesired operation.

This equipment has been tested and found to comply with the limits for a Class B digital device, pursuant to Part 15 of the FCC Rules. These limits are designed to provide reasonable protection against harmful interference in a residential installation.

This equipment generates, uses, and can radiate radio frequency energy and, if not installed and used in accordance with the instructions, may cause harmful interference to radio communications. However, there is no guarantee that interference will not occur in a particular installation.

Privacy of Communications may not be ensured when using this product. If this equipment does cause harmful interference to radio or television reception, which can be determined by turning the equipment off and on, the user is encouraged to try to correct the interference by one or more of the following measures:

- Reorient or relocate the receiving antenna (that is, the antenna for radio or television that is "receiving" the interference).
- Reorient or relocate and increase the separation between the telecommunications equipment and receiving antenna.
- Connect the telecommunications equipment into an outlet on a circuit different from that to which the receiving antenna is connected.

If these measures do not eliminate the interference, please consult your dealer or an experienced radio/television technician for additional suggestions. Also, the Federal Communications Commission has prepared a helpful booklet, "How To Identify and Resolve Radio/TV Interference Problems." This booklet is available from the U.S. Government Printing Office, Washington, D.C. 20402. Please specify stock number 004-000-0034 5-4 when ordering copies.

**Notice:** The changes or modifications not expressly approved by the party responsible for compliance could void the user's authority to operate the equipment.

# HearingAidCompatibility(HAC)

This telephone system meets FCC standards for Hearing Aid Compatibility.

## FCC RF Radiation Exposure Statement

This equipment complies with FCC RF radiation exposure limits set forth for an uncontrolled environment. This equipment should be installed and operated with a minimum distance of 20 centimeters between the radiator and your body. This transmitter must not be co-located or operated in conjunction with any other antenna or transmitter.

## IndustryCanada(I.C.)Notice

This product meets the applicable Industry Canada technical specifications.

Le présent matériel est conforme aux spécifications techniques applicables d'Industrie Canada."

The Ringer Equivalence Number is an indication of the maximum number of terminals allowed to be connected to a telephone interface. The termination on an interface may consist of any combination of devices subject only to the requirement that the sum of the Ringer Equivalence Numbers of all the devices does not exceed five.

L'indice d'équivalence de la sonnerie (IES) sert à indiquer le nombre maximal de terminaux qui peuvent être raccordés à une interface téléphonique. La terminaison d'une interface peut consister en une combinaison quelconque de dispositifs, à la seule condition que la somme d'indices d'équivalence de la sonnerie de tous les dispositifs n'excède pas 5."



This Class B digital apparatus complies with Canadian ICES-003.

Cet appareil numérique de la classe B est conforme à la norme NMB-003 du Canada.

## **IMPORTANT SAFETY INSTRUCTIONS**

When using your telephone equipment, basic safety precautions should always be followed to reduce the risk of fire, electric shock and injury to persons, including the following: 1. Do not use this product near water, for example, near a bath tub, wash bowl, kitchen sink or laundry tub, in a wet basement or near a swimming pool. 2. Avoid using a telephone (other than a cordless type) during an electrical storm. There may be a remote risk of electric shock from lightning. 3. Do not use the telephone to report a gas leak in the vicinity of the leak.

**WARNING: TO PREVENT FIRE OR ELECTRICAL SHOCK HAZARD, DO NOT EXPOSE THIS PRODUCT TO RAIN OR MOISTURE.**

 <p>THE LIGHTNING FLASH AND ARROW HEAD WITHIN THE TRIANGLE IS A WARNING SIGN ALERTING YOU OF "DANGEROUS VOLTAGE" INSIDE THE PRODUCT.</p>	<p><b>CAUTION:</b> RISK OF ELECTRIC SHOCK DO NOT OPEN</p> <p>CAUTION: TO REDUCE THE RISK OF ELECTRIC SHOCK, DO NOT REMOVE COVER (OR BACK). NO USER SERVICEABLE PARTS INSIDE. REFER SERVICING TO QUALIFIED SERVICE PERSONNEL.</p>	 <p>THE EXCLAMATION POINT WITHIN THE TRIANGLE IS A WARNING SIGN ALERTING YOU OF IMPORTANT INSTRUCTIONS ACCOMPANYING THE PRODUCT.</p>
SEE MARKING ON BOTTOM / BACK OF PRODUCT		

# **Table of Contents**

---

<b>Equipment Approval Information.....</b>	<b>2</b>
<b>Interference Information .....</b>	<b>3</b>
<b>Hearing Aid Compatibility (HAC).....</b>	<b>4</b>
<b>FCC RF Radiation Exposure</b>	
<b>Statement.....</b>	<b>4</b>
<b>Introduction .....</b>	<b>6</b>
<b>Before You Begin .....</b>	<b>7</b>
Parts Checklist .....	7
Telephone Jack Requirements .....	7
<b>Installation .....</b>	<b>7</b>
Important Installation Guidelines .....	7
<b>Base Layout .....</b>	<b>8</b>
<b>Back &amp; Side Views .....</b>	<b>9</b>
<b>Installing The Phone .....</b>	<b>10</b>
<b>Connecting the Telephone Line.....</b>	<b>10</b>
Wall Mounting .....	11
<b>Telephone Operation .....</b>	<b>12</b>
Speakerphone .....	12
Placing Call .....	12
Handset .....	12
Speakerphone .....	12
Answering a Call .....	12
Handset .....	12
Speakerphone .....	13
Volume .....	13
Amplified Audio .....	13
Audio Tone Control .....	14
Mute .....	14
Flash .....	14
Redial .....	14
<b>Memory .....</b>	<b>15</b>
Storing A Number In Memory .....	15
Adding A Pause To The Dialing	
Sequence .....	15
Changing A Stored Number .....	16
Dialing A Number From Memory.....	16
<b>Troubleshooting Guide .....</b>	<b>16</b>
<b>General Product Care .....</b>	<b>17</b>
<b>Warranty Assistance .....</b>	<b>17</b>
<b>Limited Warranty .....</b>	<b>18</b>

# Introduction

---



**CAUTION: When using telephone equipment, there are basic safety instructions that should always be followed. Refer to the IMPORTANT SAFETY INSTRUCTIONS provided with this product and save them for future reference.**

This phone is designed for those individuals with mild to severe hearing loss. The unit is designed to control the volume of the phone as well as the frequencies that fit your hearing. It has an Audio Tone control allowing you to customize the phone to your preference frequency from 600Hz to 3KHz. The phone is designed with unique features to protect the hearing in your family. You will be able to switch between automatic and manual amplification modes to protect your hearing from being exposed to dangerous sound levels.

Please read this manual very carefully before using your 1123 and keep it for future reference. If you have any questions or problems, consult the Troubleshooting Tips for the solution.

# Before You Begin

---

## Parts Checklist

Make sure your package includes the items shown here.

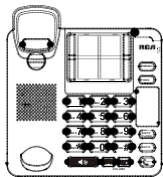

Base

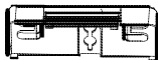

Desktop pedestal



Handset

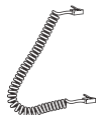

Coiled cord



Line cord

## Telephone Jack Requirements

To use this phone, you need an RJ11C type modular telephone jack, which might look like the one pictured here, installed in your home. If you don't have a modular jack, call your local phone company to find out how to get one installed.

Wall plate



## Installation

---

### Important Installation Guidelines

- Avoid sources of noise and heat, such as motors, fluorescent lighting, microwave oven, heating appliances, and direct sunlight.
- Avoid areas of excessive dust, moisture, and low temperatures.
- Avoid other cordless telephones or personal computers.
- Never install telephone wiring during a lightning storm.
- Never install telephone jacks in wet locations unless the jack is specifically designed for wet locations.
- Never touch non-insulated telephone wires or terminals, unless the telephone line has been disconnected at the network interface.
- Use caution when installing or modifying telephone lines.

# BaseLayout

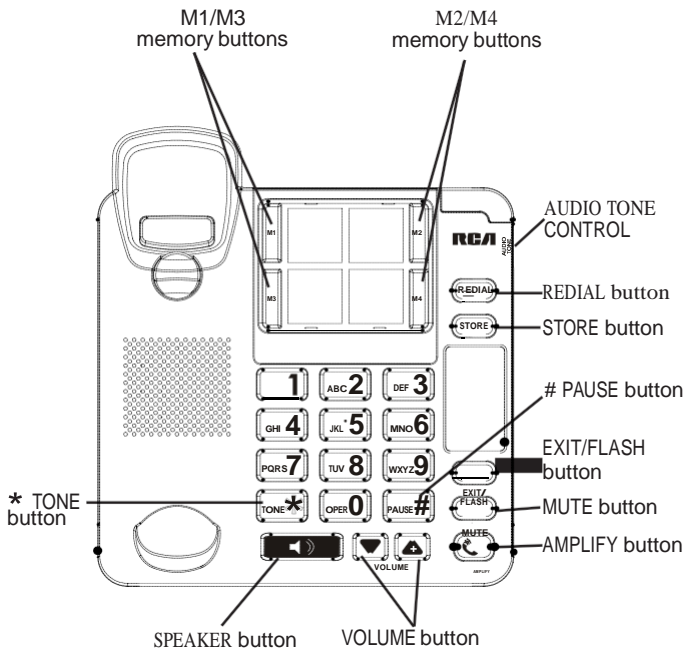



## Back & Side Views

---

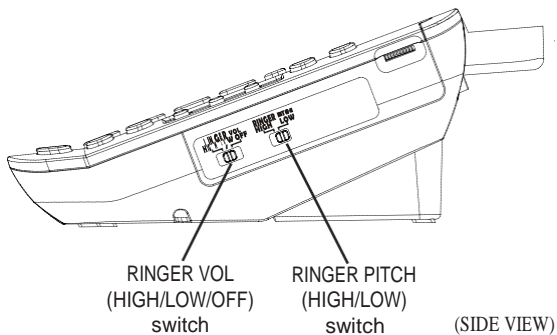
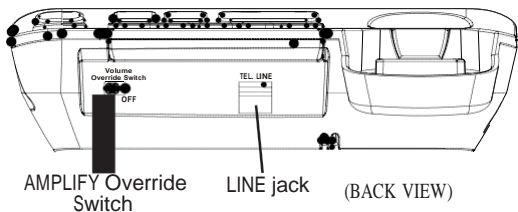

# Installing the Phone

---

## Connecting the Telephone Line

**NOTE: The unit is shipped from the factory for placement on a level surface.**

1. Choose an area near a telephone wall jack (RJ11C), and place your cordless telephone on a level surface, such as a desktop or tabletop, or you may mount it on the wall.
2. Plug one end of the telephone line cord into the Line jack at the back of the base and the other end into a modular jack.
3. If you have another device (example, an additional auxiliary phone or data modem) need to be connected to the unit, please connect it to the Data jack on the back of the unit.
4. Connect one end of the coiled handset cord to the jack on the handset.
5. Plug the other end of the coiled handset cord to the jack on the base.
6. Adjust the RINGER VOLUME switch to the desired setting: HIGH, LOW or OFF.

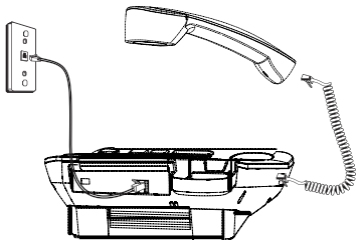

The unit is properly installed if you pick up the handset and hear the dial tone. If you don't hear a dial tone, recheck all the installation steps.

## Wall Mounting

To detach the desktop pedestal:

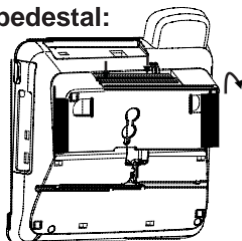

1. Rotate the hook 180°. (Refer to Dia.1A)
2. Plug one end of the straight telephone line cord into the jack on the bottom of the base.
3. on the bottom of the base unit if you've opened them before.
4. Feed the line cord through the groove and plug the end into the modular telephone jack. Excess telephone line can be stuffed into the recess area on the bottom of the Base Unit.
5. Slip the mounting holes (on the bottom of the base) over the wall plate posts and firmly slide the unit down into place.

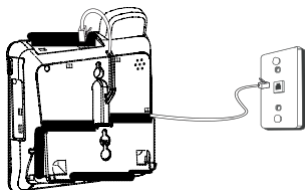
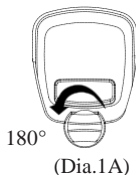

# **Telephone Operation**

---

## **Speakerphone**

For hands-free operation and convenience, this unit is equipped with a speakerphone.

For best speakerphone performance, avoid the following:

- Areas with high background noise. (The microphone might pick up these sounds and prevent the speakerphone from going into the receiving mode when you finish talking.)
- Surfaces affected by vibration.
- Recessed areas such as in a corner, under a cupboard, or next to a cabinet, which can generate an echo effect.

### **Note the following guidelines when using the speakerphone:**

- The speakerphone works similar to a two-way radio in that you can only listen or talk at one time.
- Stay reasonably close to the phone so that you can be clearly heard by the person to whom you are talking.
- You can adjust the speaker volume by adjusting the volume (□ or □) buttons while speakerphone is in use.
- The speakerphone indicator comes on when the speakerphone is in use.

## **Placing a Call**

### **Handset**

1. Pick up the handset and listen for a dial tone.
2. Dial the number you want to call.
3. When finished, hang up the handset.

### **Speakerphone**

1. Press the speaker button on the base and listen for a dial tone.
2. Dial the number you want to call.
3. When finished, press the speaker button to hang up.

## **Answering a Call**

**NOTE: Make sure the ringer switch is set to HI or LO, or the phone will not ring. The visual ring indicator will flash at all settings.**

### **Handset**

1. When the phone rings, pick up the handset.
2. When finished, hang up the handset.

## Speakerphone

1. When the phone rings, press the speaker button to answer a call.
2. When finished, press the speaker button to hang up.

You may switch between the speakerphone and the handset during the dialing process or anytime during a conversation. **Speakerphone to Handset** -Pick up the handset to disable the speakerphone. The speakerphone indicator turns off. **Handset to Speakerphone** -Press the speaker button, and then hang up the handset. The speakerphone indicator turns on and the handset is disabled.

## Volume

You can control the volume of both the handset receiver and the speakerphone.

While using the handset or speakerphone, you may adjust the volume to the desired listening level by using the volume (□ or □) buttons. Handset volume has 4 levels for adjustment and Speaker volume has 8 levels.

## Amplified Audio

You may press the amplify button to temporarily boost the volume of the handset receiver during a call. To return to normal levels, press the button again. Volume levels will also return to normal when handset is replaced on base after call.

The "AMPLIFY" button controls the increased volume level and audio tone of the handset.

1. Press the volume (□ or □) button to minimum, pick up the handset and press the amplify button to turn on the incoming voice amplifier. The indicator around the button illuminates.
2. Adjust the volume by pressing the volume (□ or □) button. When the amplify button is pressed, an extra level of amplified volume is added providing up to 40dB of gain and level control. In standard use, the amplifier turns off whenever you hang up the telephone. If you want the amplifier to turn on whenever you pick up the handset, slide the Amplify Override switch located at the back of the unit to ON.

**NOTE: AMPLIFY feature is possible in both Handset and Speaker Mode.**



**WARNING:** This Product is designed for users with hearing disabilities and automatically amplifies the volume to the highest level when the Amplify Override switch is set to “ON”. If you wish to prevent the automatic amplification, please turn the Amplify Override switch located on the back of the set to “OFF”.

## Audio Tone Control

The phone's Audio Tone Control boosts the sound of the frequency range from 600Hz to 3KHz to compensate for the ear's limited sensitivity in the range.

1. To turn on the Audio Tone Control, press the “amplify” button after you pick up the handset, or any time during the a call. The indicator around the button illuminates.
2. To adjust the setting, rotate the Audio Tone Control to select the specific frequency range.
3. To turn off the Audio Tone Control press the “amplify” button and the indicator light turns off.

## Mute

Use the mute button to interrupt a phone conversation to talk privately with someone else in the room. A conversation can be muted while using the speakerphone, handset or neck loop.

1. Press the mute button. The mute indicator illuminates.
2. Press mute again to turn it off.

**Note: Switching from speakerphone to handset cancels mute.**

## Flash

Press the flash button to activate customer calling services such as call waiting or call transfer, which are provided by your local phone company.

## Redial

You may redial the last number you called by pressing the redial button after you get a dial tone.

**NOTE: The Redial feature holds in memory the last phone number you dialed (as many as 32 digits). If you pressed any numbers after dialing the phone number, (for example, when accessing a voice-menu system) those numbers also are redialed.**

# Memory

---

Store as many as 4 numbers in memory for easy dialing. They can be stored the one-touch memory on the top of the Base unit. You can use the space provided to **either write the name of your contacts or stick pictures** for easy recognition.

## Storing a Number in Memory

1. Pick up the handset or press **SPEAKER**.
2. Press the **STORE** button.
3. Dial the number to be stored (up to 16 digits).
4. Press the **STORE** button.
5. Select and press any of the one-touch Memory Location buttons.
6. Hang up the phone or press the **SPEAKER** button.

## Adding a Pause to the Dialing Sequence

Use the #pause button to insert a delay in the dialing sequence when storing a number, for example, when you need to dial 9 to get an outside line.

Pause function is enabled when the #pause button is pressed and held for 2 seconds.

Press and hold #pause button at the point in the dialing sequence in which a pause is required.

The pause time is approximately four seconds, if additional time is needed, press and hold the #pause button again.

## Changing a Stored Number

Follow the same steps as “Storing a Number into Memory.” The new numbers will overwrite the existing numbers.

## Dialing a Number from Memory

You can dial numbers from memory when using the handset or speakerphone. When you get a dial tone, press the one-touch memory button for the number you want to dial.

## Troubleshooting Guide

---

### No dial tone

- Check installation:  
Make sure the telephone line cord is connected to the base unit and the wall phone jack.
- Check the hook switch. Make sure it fully extends when the handset is lifted from the cradle.
- You must have touch-tone service on your line to use this phone. If you do not know what type of service you have, check with the phone company.
- Make sure speakerphone indicator comes on (if using speakerphone.)
- Unplug the phone, wait 30 seconds, and plug the phone back in. Then lift the handset to check the dial tone.
- Connect another phone to the same modular jack; if the second phone doesn't work, the problem might be with your wiring or local service.
- Place the handset in the base for at least 20 seconds.

### Phone doesn't ring

- Make sure ringer switch is set to LO or HI.
- You may have too many extension phones on your line. Unplug some extension phones.
- Check for a dial tone. If there is no dial tone, see solutions for “No dial tone.”

---

### Low handset or speaker volume

- Check the receiver or speaker volume settings.

---

### Can't be heard by other party

- Make sure phone cord is securely plugged in.
  - Make sure extension phones are on the hook at the same time you're using the phone. It is normal for the volume to drop when additional extension phones are used at the same time.
-



## Memory dialing

- Make sure you entered numbers correctly. (See “Memory.”)
  - Make sure the telephone is properly installed. Pick up the handset and listen for the dial tone. If you don't hear the dial tone, recheck or repeat the installation steps.
- 

## General Product Care

---

To keep your telephone working and looking good, follow these guidelines:

- Avoid putting the phone near heating appliances and devices that generate electrical noise (for example, motors or fluorescent lamps ).
- DO NOT expose to direct sunlight or moisture.
- Avoid dropping the unit and other rough treatment.
- Clean with a soft cloth.
- Never use a strong cleaning agent or abrasive powder because this will damage the finish.
- Retain the original packaging in case you need to ship the phone at a later date.

## **Warranty Assistance**

Your sales receipt will be required to demonstrate proof of purchase in order to validate your warranty eligibility. You may want to attach either the original, or a photocopy, of your sales receipt to this booklet for future reference.

If this product was received as a gift, it is suggested you jot down the date of gift receipt, as this information will be valuable should service be required during the warranty period. If the equipment is causing harm to the telephone network, the telephone company may require that you disconnect the equipment until the problem is resolved.

Purchase Date or Date Received as Gift \_\_\_\_\_

Name of Store \_\_\_\_\_

For instructions on how to obtain warranty service, you may call Customer Care at 1-877-722-4908 or you may visit our website at [www.rca4phones.com](http://www.rca4phones.com). If you prefer, you may write to us at:

Supreme Power USA LLC

PO Box 501045

Indianapolis IN 46250-1045

Please do not send products to this address as it only adds delays in service and may result in lost or damaged product. This PO BOX is for written communication only.

If the equipment is causing harm to the telephone network, the telephone company may require that you disconnect the equipment until the problem is resolved.

## **Limited Warranty**

What your limited warranty covers:

- Defects in materials or workmanship.

For how long after your purchase:

- One year, from date of purchase. Please retain your sales receipt, as that will act as your proof of purchase in order to validate warranty status.

What we will do:

- Provide you with a new or, at our option, a refurbished exchange unit of same or similar model. The exchange model is under warranty for the remainder of the original product's one year warranty, or 90 days from the date the replacement product was shipped to you, whichever is longer.

How to get service:

- Call Customer Care at 1-877-722-4908. Please have your product with you and please have your model number and date code available when calling us. The model number and date code can be found on the underside of the base unit.

**If you are within your limited warranty period and it is determined that service is required:**

- We will ask that you properly pack your product to avoid shipping damage. We recommend that you use the original carton and packing materials.
- We will ask you to include with your product the following:
  - o Your name, return shipping address and daytime phone number handwritten or typed on a sheet of paper
  - o A legible copy of your sales receipt ( please do not send the original sales receipt )
- Ship your product prepaid, to the address we provide. We suggest shipping your product via a traceable carrier, as we are not responsible for lost, mis-directed or damaged shipments. You may want to write the date shipped, carrier and tracking number here:

- 
- Upon receipt of your product we will validate your product is under warranty and if determined your product is warranty eligible, we will ship to you a new or, at our option, a refurbished exchange unit of same or similar model. This exchange unit will be shipped to you at no cost.

**What your limited warranty does not cover:**

- Customer Instruction. (Your Owner's Manual provides information regarding operating and install instructions. Additional information may be obtained by contacting the retailer)
- Installation and set-up service adjustments.
- Batteries.
- Damage from misuse, neglect, unauthorized repair.
- Products which have been modified or incorporated into other products
- Products that have been serviced by an unauthorized servicer.
- Products purchased or serviced outside the USA or Canada.
- Acts of nature, such as but not limited to, lightning damage.

**Limitation of Warranty:**

- **THIS LIMITED WARRANTY IS THE ONLY WARRANTY APPLICABLE TO THIS PRODUCT. ALL OTHER WARRANTIES, EXPRESS OR IMPLIED (INCLUDING ALL IMPLIED WARRANTIES OF MERCHANTABILITY OR FITNESS FOR A PARTICULAR PURPOSE) ARE HEREBY DISCLAIMED. NO VERBAL OR WRITTEN INFORMATION GIVEN BY SUPREME**

POWER USA LLC, ITS AGENTS, EMPLOYEES, RETAIL DEALERS OR INDEPENDENT CONTRACTORS SHALL CREATE A GUARANTY OR IN ANY WAY INCREASE THE SCOPE OF THIS WARRANTY.

- REPAIR OR REPLACEMENT AS PROVIDED UNDER THIS WARRANTY IS THE EXCLUSIVE REMEDY OF THE CONSUMER. SUPREME POWER USA LLC SHALL NOT BE LIABLE FOR INCIDENTAL OR CONSEQUENTIAL DAMAGES RESULTING FROM THE USE OF THIS PRODUCT OR ARISING OUT OF ANY BREACH OF ANY EXPRESS OR IMPLIED WARRANTY ON THIS PRODUCT. THIS DISCLAIMER OF WARRANTIES AND LIMITED WARRANTY ARE GOVERNED BY THE LAWS OF THE STATE OF INDIANA EXCEPT TO THE EXTENT PROHIBITED BY APPLICABLE LAW, ANY IMPLIED WARRANTY OF MERCHANTABILITY OR FITNESS FOR A PARTICULAR PURPOSE ON THIS PRODUCT IS LIMITED TO THE APPLICABLE WARRANTY PERIOD SET FORTH ABOVE.

**How state law relates to this warranty:**

Some states do not allow the exclusion nor limitation of incidental or consequential damages, or limitations on how long an implied warranty lasts so the above limitations or exclusions may not apply to you.

This warranty gives you specific legal rights, and you also may have other rights that vary from state to state.

**If you purchased your product outside the USA or Canada:**

This warranty does not apply. Contact your dealer for warranty information.

Product Registration:

- Please complete and mail the Product Registration Card packed with your product or visit [www.rca4phones.com](http://www.rca4phones.com) to register your new product. Product registration is not required for warranty coverage but does allow us to contact you should it be necessary.

**Visit the RCA website at [www.rca4phones.com](http://www.rca4phones.com)**

Please do not send any products to the Indianapolis address listed in this manual or on the carton. This will only add delays in service for your product.