



DIGITAL QUARTZ STOPWATCH WITH SPLIT AND LAP TIME MEASUREMENT AND STROKE/FREQUENCY MEASURING FUNCTIONS

FEATURES

The Quartz Stopwatch is a digital stopwatch featuring memory and stroke/frequency measuring functions. In addition, the stopwatch is water resistant. Therefore, it is suitable for aquatic sports or use in rainy weather.

■ **STOPWATCH**

The stopwatch can measure up to 10 hours in 1/100 seconds..

■ **SPLIT TIME/LAP TIME MEASUREMENT**

Up to 300 split times and lap times can be measured.

■ **LARGE-SIZED THREE-ROW DISPLAY PANEL**

Accumulated elapsed time / Lap time in progress, split time and lap time are displayed at the same time in separate rows, and they can be measured successively without releasing split or lap time measurement.

CALIFORNIA, USA ONLY

This Perchlorate warning applies only to primary CR(Manganese Dioxide) Lithium coin cells sold or distributed ONLY in California USA.
*Perchlorate Material-special handling may apply.
See www.dtsc.ca.gov/hazardouswaste/perchlorate.

BK230

Printed in China

■ **MEMORY FUNCTION**

Up to 100 measurements can be stored in memory, and they can be recalled after measurement is over.

■ **TIME/CALENDAR DISPLAY**

Year, month, date, hour, minutes and seconds can be displayed while the stopwatch is not used.

■ **BATTERY**

Lithium battery CR2032 or equivalent is used.

There are four buttons as indicated in the illustration below

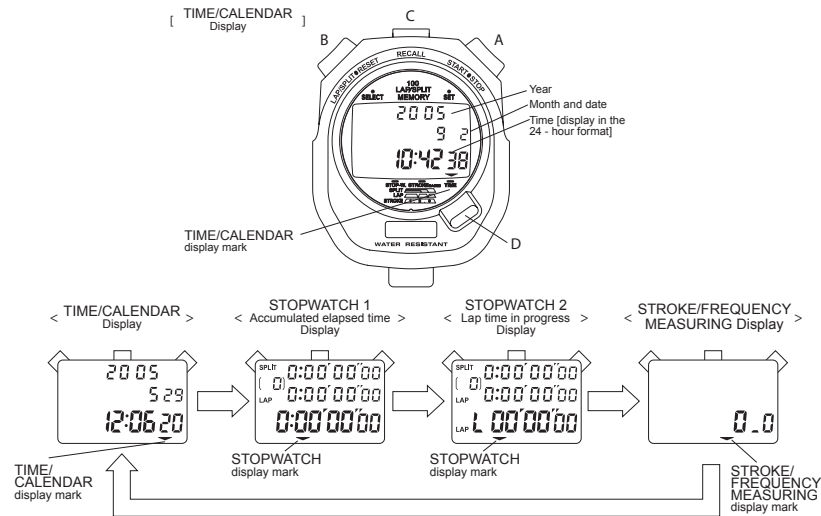

TIME/CALENDAR SETTING

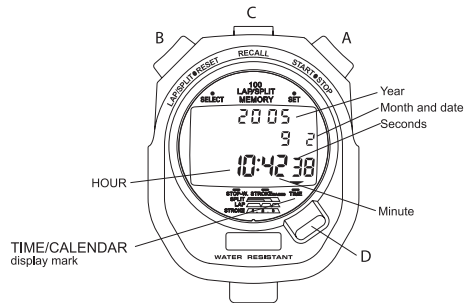

1. Press “D” to show the TIME/CALENDAR display. The TIME/CALENDAR display mark will appear.
2. Press “B” repeatedly to select the digits (flashing) to be adjusted. With each press of “B”, the digits to be adjusted change over in the following order.



3. Press “A” to set the flashing digits or reset the seconds to “00”
 - * The digits move quickly if “A” is kept pressed.
 - * When the seconds digits count any number from “30” to “59” and “A” is pressed, one minute is added and the second digits are reset to “00”.
4. After all the adjustments are completed, press “B” to return to the TIME/CALENDAR display.

Notes:

1. Hour digits are displayed in the 24-hour format.
2. Year digits can be set from 2000 to 2099. The calendar adjusts automatically for odd and even months including February of leap years.

STOPWATCH

Press "D" in the TIME/CALENDAR display to show the STOPWATCH display.

The STOPWATCH display mark will appear.

The stopwatch can be measure up to 10 hours in hours, minutes, seconds and 1/100 seconds.

* Before using the stopwatch, be sure to reset the digits to "0:00'00"00".

When the stopwatch is stopped, press "B".

When the stopwatch is counting, press "A" to stop the measurement and then press "B"

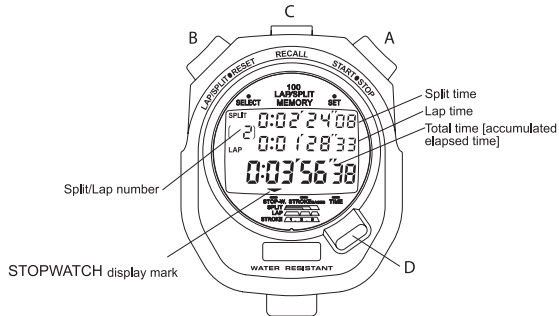

* "Split time" refer to an elapsed time required to cover a distance from the start to a given point.

"Lap time" refers to an elapsed time required to cover a given section of the whole distance.

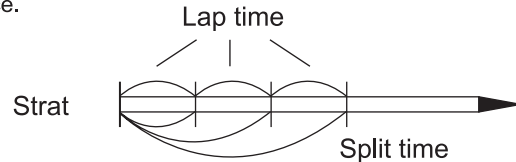

1. STANDARD MEASUREMENT

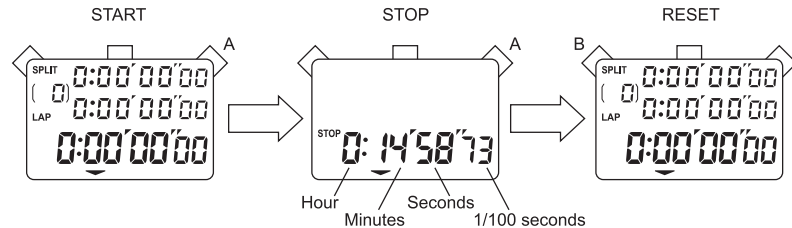

2. ACCUMULATED ELAPSED TIME MEASUREMENT

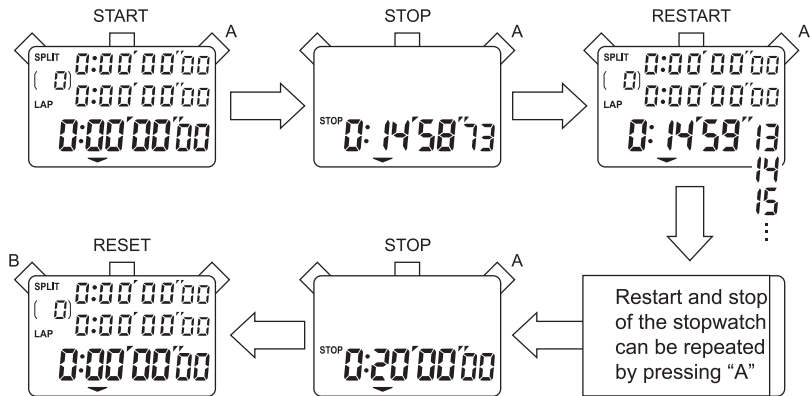

3. SPLIT TIME/LAP TIME MEASUREMENT

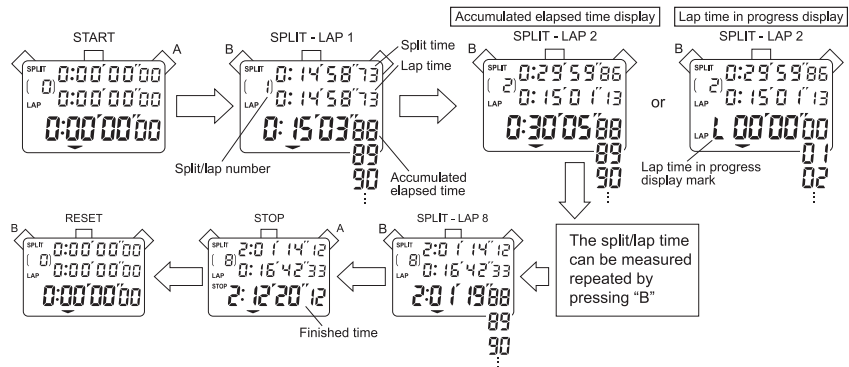

- Note:**
1. When the number of stored measurements exceeds 90, flashing "FULL" appears, and when it exceeds 300, a warning sound start beeping.
 2. In the lap time in progress display, when the lap time measurement in progress exceeds 1 hour, the hour digit appears in place of the mark for lap time in progress display.

4. HOW TO USE THE MEMORY FUNCTION

The stopwatch can store up to 300 split times, 300 lap times and total elapsed time. They are automatically entered into the memory.

* With each press of “C”, the time stored is recalled. The time can be recalled successively by keeping the button pressed.

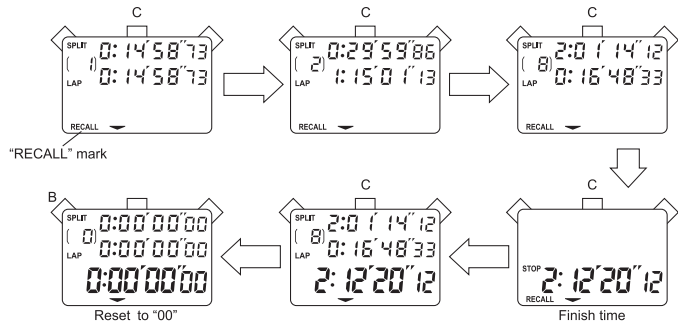

* To stop the recall of the stored data, press “B” or “D”. The measurements when the stopwatch was stopped will be shown. Then press “B” to reset the digits to “00”.

* The time stored in the memory can be recalled even while the stopwatch is measuring.

	With each press of “C”
When the stopwatch is stopped	Split time and lap are recalled starting with the first ones.
When the stopwatch is measuring	The times are recalled starting with the last ones.

* To measure the lap time and split time while the stored data are recalled operate the buttons as follows.

Press “B” to measure new lap time and split time.
 Press “A” to stop the measurement.
 Press “D” to return to the measurement mode.

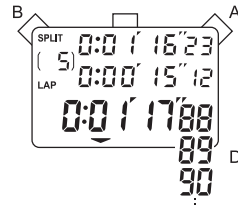

Notes:

1. Even if the digits are reset to “00”, stored times are not erased and can be recalled by pressing “C” unless new measurement is started.

STROKE/FREQUENCY MEASURING

Press "D" to show the STROKE/FREQUENCY MEASURING display.
Start the measurement by pressing "A" and stop the measurement by pressing "A" after the third stroke was made. The number of strokes per minute will be displayed.

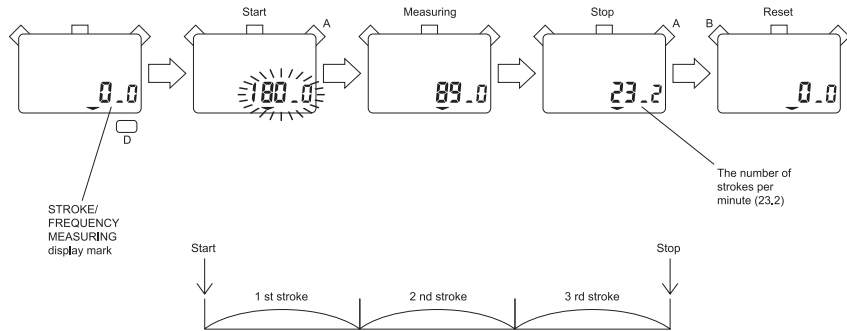

Notes:

1. During 1 second after the measurement has been started by pressing "A", flashing "180-0" is displayed. If the measurement is stopped by pressing "A" during this period, "Err" will appear. If the measurement is not stopped by pressing "A" after more than 18 seconds have elapsed, "Err" will automatically appear. Therefore, note that measurable number of strokes per minute is between 10 and 180.

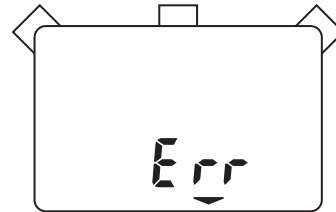

2. If "B" is pressed while the measurement is stopped or "Err" is shown, the digits will be reset to "0-0". Even if the digits are not reset to "0-0" with the measurement stopped or "Err" shown on the display, the measurement can be started by pressing "A".

BATTERY CHANGING INSTRUCTIONS

Power and Reset

Battery life: 2 years

Battery type: CR2032 Lithium or Equivalent

Avoid touching any electrical components on the PCB when the back cover is removed.

When the display becomes dim or turned off, battery replacement is necessary. Unscrew and remove the back cover. Push the left hand side of the battery holder. Battery will slide out. Replace a new Lithium battery CR2032 or equivalent with positive side facing up. Connect the two AC pads one second using a metal tool such as paperclip or screwdriver. Re-screw the back cover.

IMPORTANT: Power up and Reset

If you have a problem with the stopwatch when you replace new battery, you can try to reset the electronic circuit by using a metal paperclip or screwdriver to connect the 2 metal pads in the “AC” pad near the battery.

