

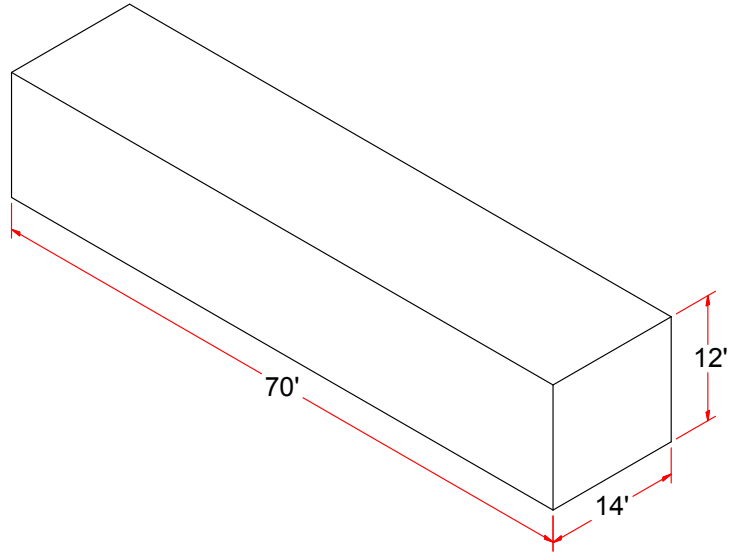

BBC36-7014 - 70' x 14' INDOOR TUNNEL NET



Mesh Size:	1-3/4" (45mm) Square opening measured between mesh joints
Mesh Break:	260 lbf (1.15 kN)
Weight:	0.0385 lb/ft ² (188 g/m ²)
Melting Point:	455 °F (235 °C)
UV:	Extra UV Stabilizers added
Color:	Black, Latex Bonded
Twine Style:	210/96
Fiber:	High Tenacity Nylon
Cord Diameter:	#36 (2.5 mm)
Twine Type:	3-Strand Twisted

BBC36-7014 is a black knotted netting with 1-3/4" mesh size ideal for use with baseball batting cages. Netting comprized of high tenacity fiber resistant to abrasion and light weight. All perimeters of netting shall be sewn together and bound to a 3/8" polypropylene rope. Netting shall be sufficient size to allow for approximately 1' of netting to lay on the floor when caged is beign used.

PROJECT NAME _____

PROJECT NUMBER _____

ARCHITECT _____

CONTRACTOR _____

NOTES _____



BBC36-7014
 BLACK NYLON 1-3/4" SQUARE
 INDOOR TUNNEL NET
 © COPYRIGHT 2014 JAYPRO SPORTS, LLC. ALL RIGHTS RESERVED
 THIS PRINT IS THE PROPERTY OF JAYPRO SPORTS, LLC. AND MAY
 NOT BE REPRODUCED WITHOUT WRITTEN PERMISSION

www.jaypro.com
 (800) 243-0533
 976 Hartford Turnpike
 Waterford, CT 06385 USA
 Sheet 1 of 1