

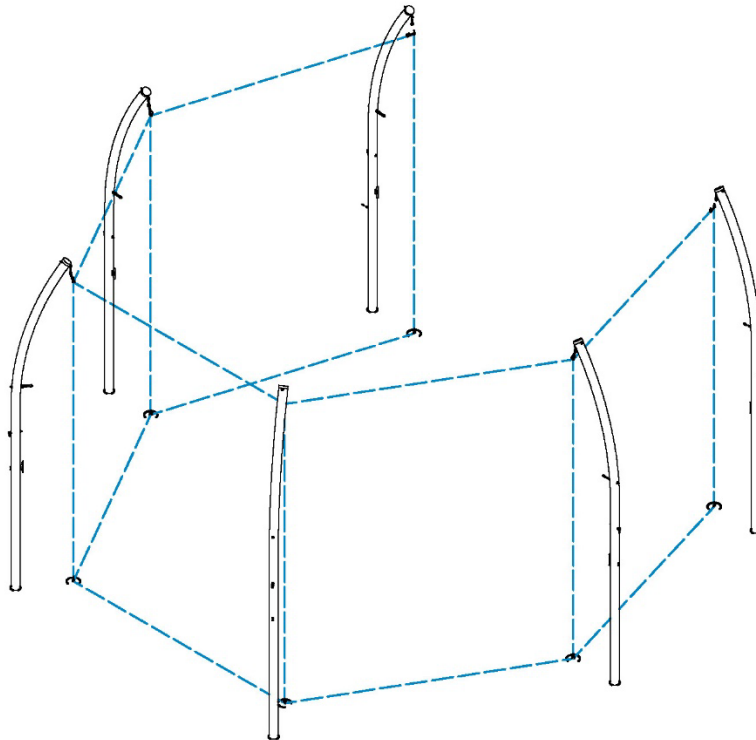











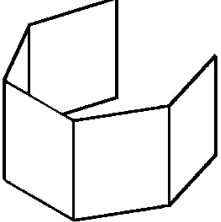

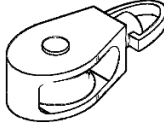
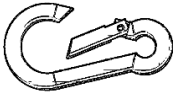
--- DCHS-35 ---  
(HIGH SCHOOL DISCUS CAGE)  
Installation Instructions

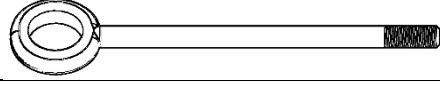
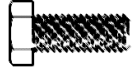
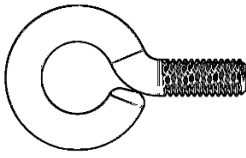

Call Jaypro Sports Equipment at 1-800-243-0533  
during regular business hours for technical support.

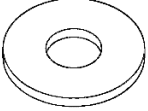
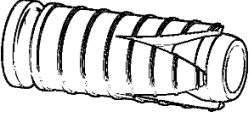
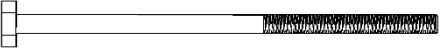
[www.jaypro.com](http://www.jaypro.com)

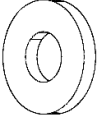
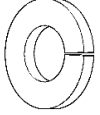
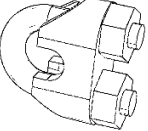
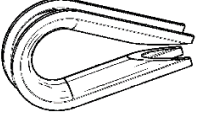
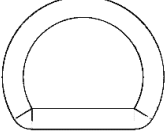
| PARTS LIST HIGH SCHOOL DISCUS CAGE  |          |  |
|---|----------|--|
| IMAGE   | QTY      | DESCRIPTION  |
|    | 6        | H.S. DISCUS POLE   |
|    | 1        | DISCUS NET   |
|    | 6        | 4" PLASTIC PIPE CAPS, BLACK  |
|    | 12       | 1" SWIVEL PULLEY   |
|   | 24       | 5/16" x 3 1/8" SNAP HOOK   |
|  | x6<br>x1 | 5/16 DOUBLE BRAIDED BLACK ROPE x 20 FT<br>5/16 DOUBLE BRAIDED BLACK ROPE x 56 FT |
|  | 1        | VINYL COATED 1/4" AIR CRAFT CABLE x 56 FT  |
|  | 12       | 3/8"-16 x 5" LONG THREADED EYEBOLT, ZP   |
|  | 6        | 3/8"-16 x 1" LONG HEX HD SCREW, SS   |
|  | 6        | 3/8"-16 x 2-1/2" OA LENGTH EYEBOLT, SS   |
| IMAGE   | QTY      | DESCRIPTION  |

| IMAGE   | QTY | DESCRIPTION                          |
|---|-----|--------------------------------------|
|    | 12  | 3/8"-16 HEX HD LOCKNUT, ZP           |
|    | 24  | 3/8" FLAT WASHER, ZP                 |
|    | 6   | 3/8"-16 TREADED EXPANSION ANCHOR, ZP |
|    | 12  | 1/4"-20 x 5 1/2" HEX HD SCREW, ZP    |
|    | 12  | 1/4"-20 NYLON LOCKNUT, ZP            |
|   | 12  | 1/4" SAE FLAT WASHER, ZP             |
|  | 36  | 1/4" SPLIT LOCK WASHER, ZP           |
|  | 8   | 1/4" WIRE ROPE CLIPS                 |
|  | 2   | 1/4" WIRE ROPE THIMBLES              |
|  | 4   | D-RING                               |
|  | 50  | CABLE TIE 8" 120 LB Tensile BLACK UV |
|  | 6   | 6" LONG GALV. STEEL CLEAT            |
| IMAGE   | QTY | DESCRIPTION                          |

**IMPORTANT NOTICE:**

- 1) BEFORE EACH USE CHECK EQUIPMENT FOR PROPER CONNECTING HARDWARE AND STRUCTURAL INTEGRITY. REPLACE DAMAGED OR MISSING HARDWARE IMMEDIATELY.
- 2) USE OF THIS EQUIPMENT OTHER THAN INTENDED, MAY BE HAZARDOUS.
- 3) ALTERATION OR MODIFICATION OF THIS EQUIPMENT MAY BE HAZARDOUS AND RESULT IN INJURY. FOR REPAIR OR REPLACEMENT, CONTACT YOUR DEALER OR JAYPRO SPORTS.

**TOOLS REQUIRED:**

- (1) 7/16" and 9/16" Socket Wrench and Box Wrench
- (1) 7/16" Nut Driver
- (1) Rubber Mallet

**Layout & Excavation:**

- 1) Note these are suggested dimensions for average soil conditions, consult local building codes.
- 2) Dig six 30" deep x 24" wide holes for the pole and six 20" deep x 6" wide holes for the net anchor shown in figure 1. Ground sleeves sold separately. (DCHS-6S)
- 3) For the pole footing, pour 6" concrete footing and allow fully curing, or use two concrete blocks or crushed stone, to rest ground sleeve on (figure 2). Wait 48 hours before inserting poles.
- 4) Pour the anchor footing and let cure for 48 hours. Using an 11/16" drill bit, drill a hole to install the expansion anchor. Insert the eyebolt and tighten down the jam nut.

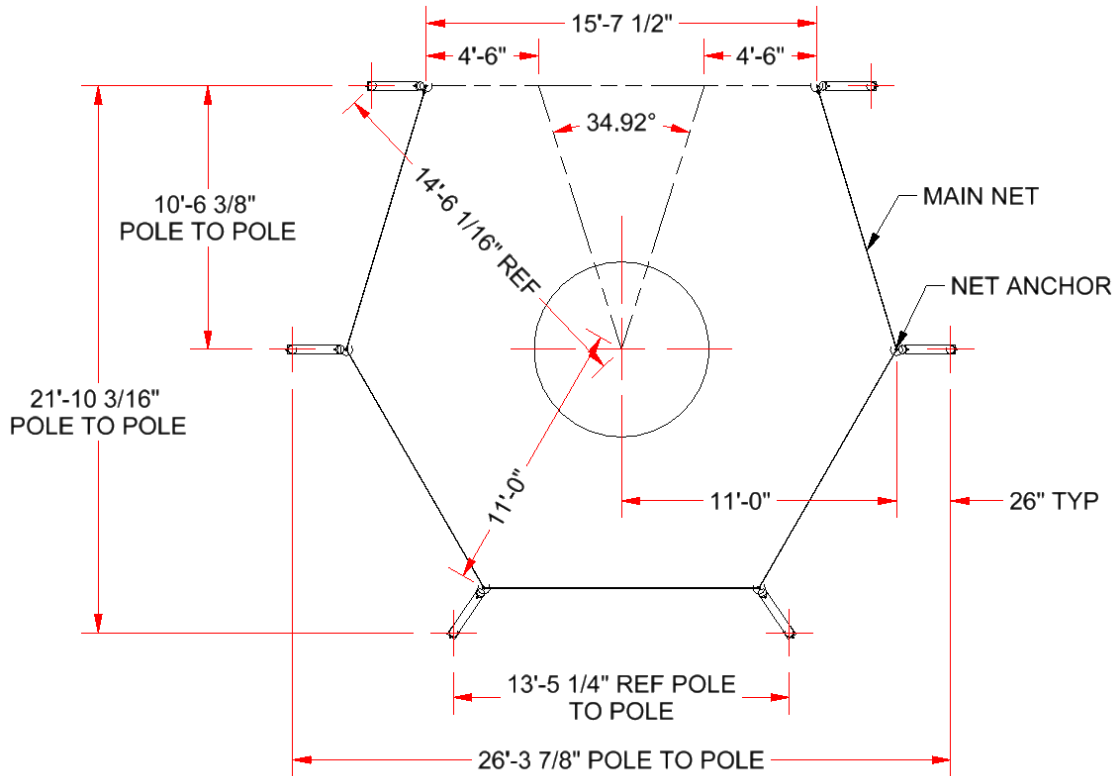
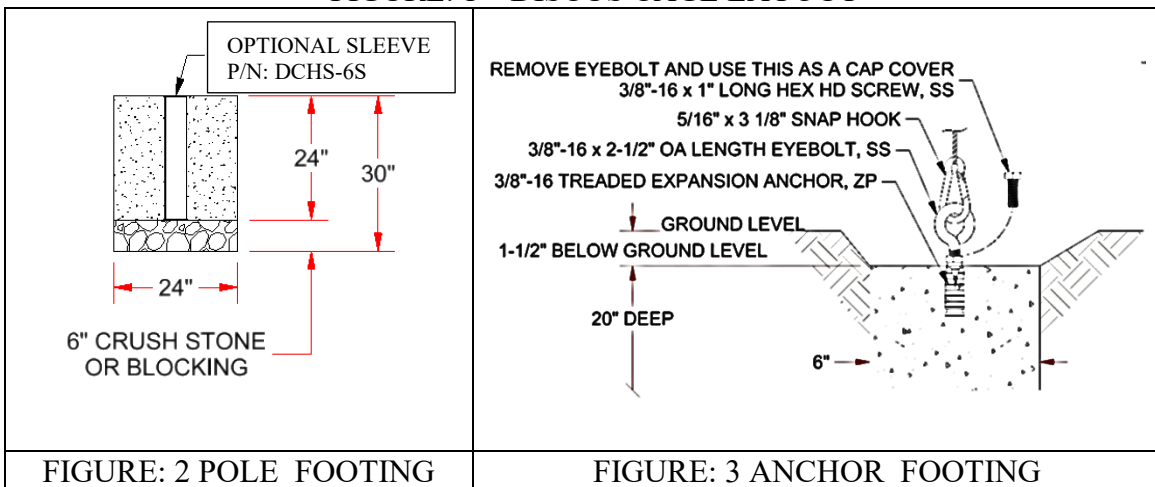

FIGURE: 1 – DISCUS CAGE LAYOUT



**Install Pole Hardware:**

- 1) Assemble two sets of 3/8" eyebolt hardware & 1/4" cleat hardware and pole cap onto the poles as show in figure 4. Route the hoisting rope through the pulley.
- 2) Attach the snap hook to the hoisting rope with a bowline knot. Temporarily attach the free end of the hoisting rope to the snap hook.

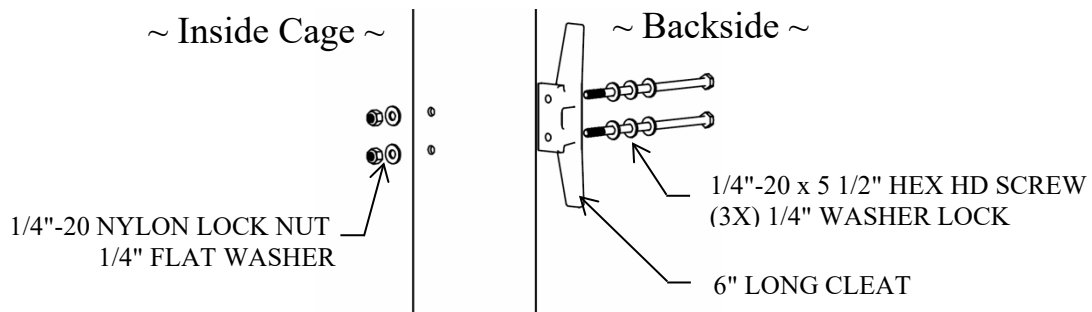
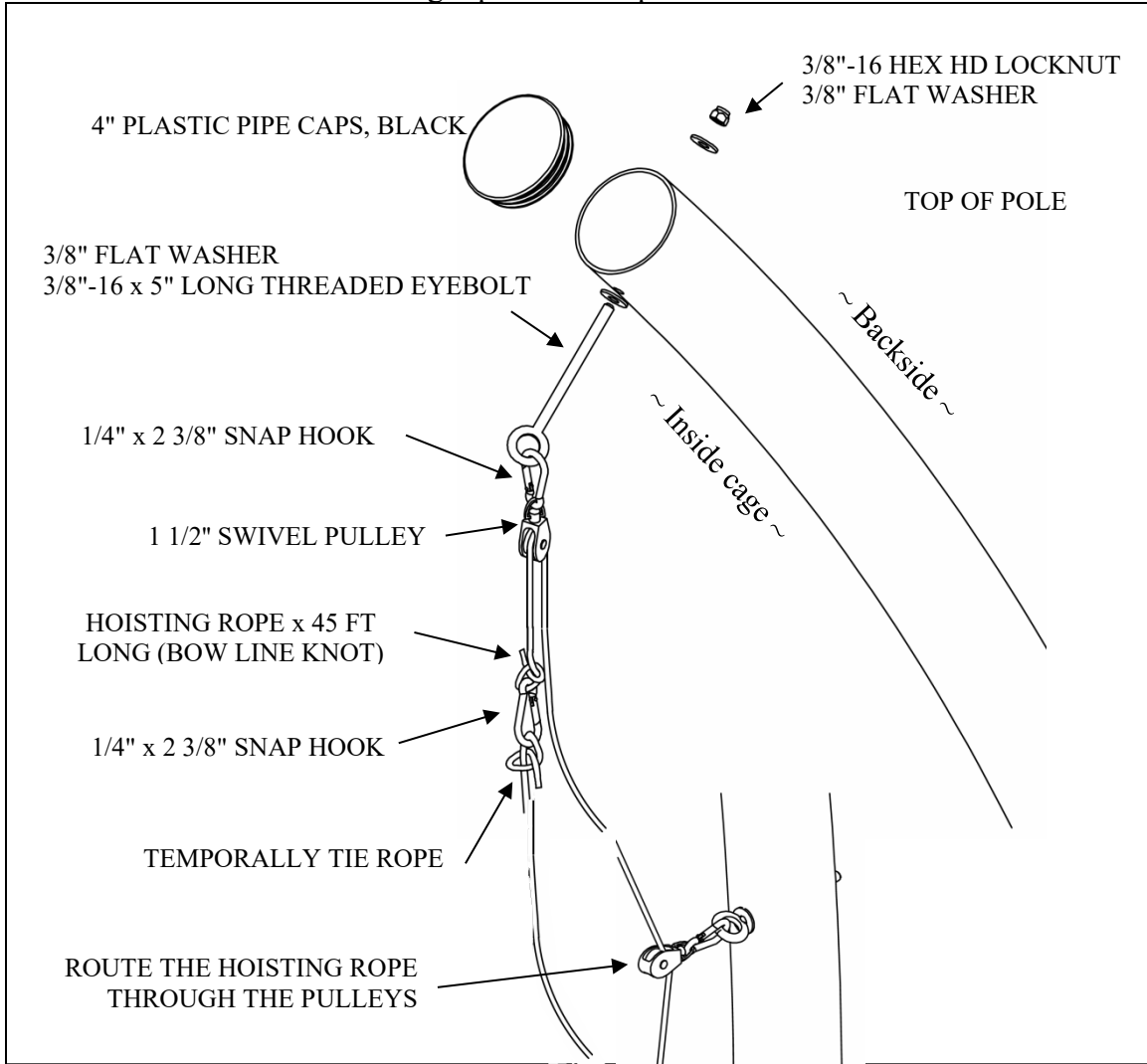

FIGURE: 4 – TYP POLE HARDWARE

### **Layout Pole & Net:**

- 1) Before inserting the poles into the sleeves, check to make sure:
  - i) The cleat installed opposite of the pulley.
  - ii) Run the hoisting rope thru pulley.
  - iii) Secure both ends together (loosely).
- 2) Lay the net out lengthwise and cut the 3/16" coated aircraft cable to length, extending each end enough to make up the loop.
- 3) Make up a loop, as shown in figure 6, on both ends of the cable.
- 4) Attach a cable to the top edges of the net using cables.

### **Install Net:**

- 1) Attach D-Rings to the net at each intermediate pole location.
- 2) Attach the hoisting ropes to each cable end and D-Ring.
- 3) Slowly raise the net up. Once the net is fully raised, secure the bottom edge of the net to the ground anchor snap hooks.

### **Install Optional Barrier Net:**

- 1) Attach the top edge of the barrier net with snap hooks. On the bottom edge secure to the pole with 12" Velcro straps.

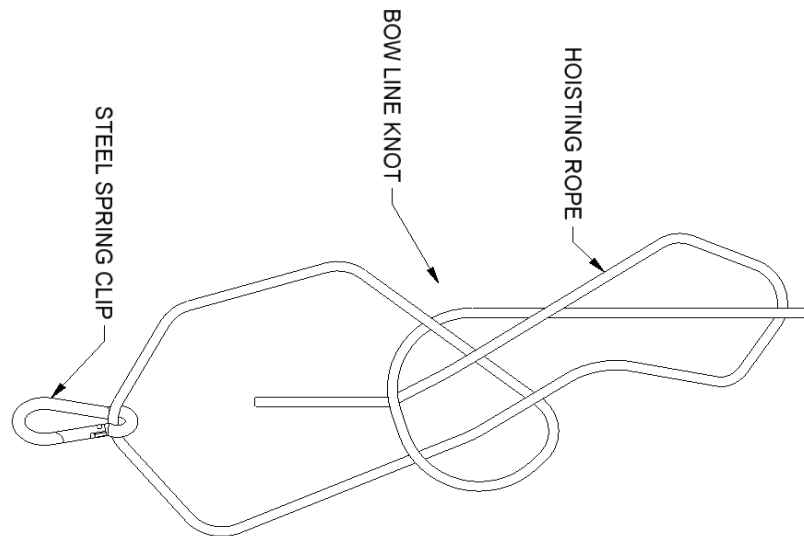

FIGURE: 5 – TYP HOIST END

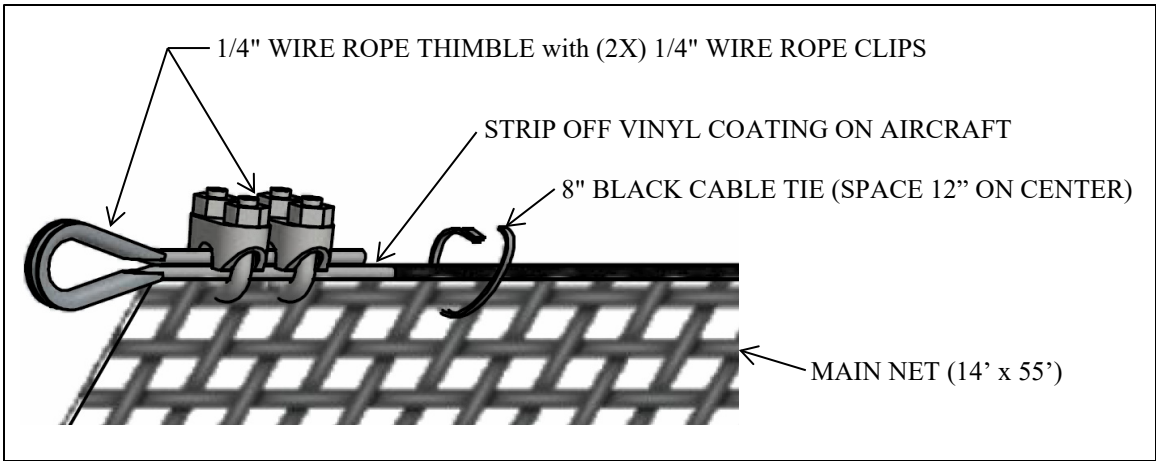
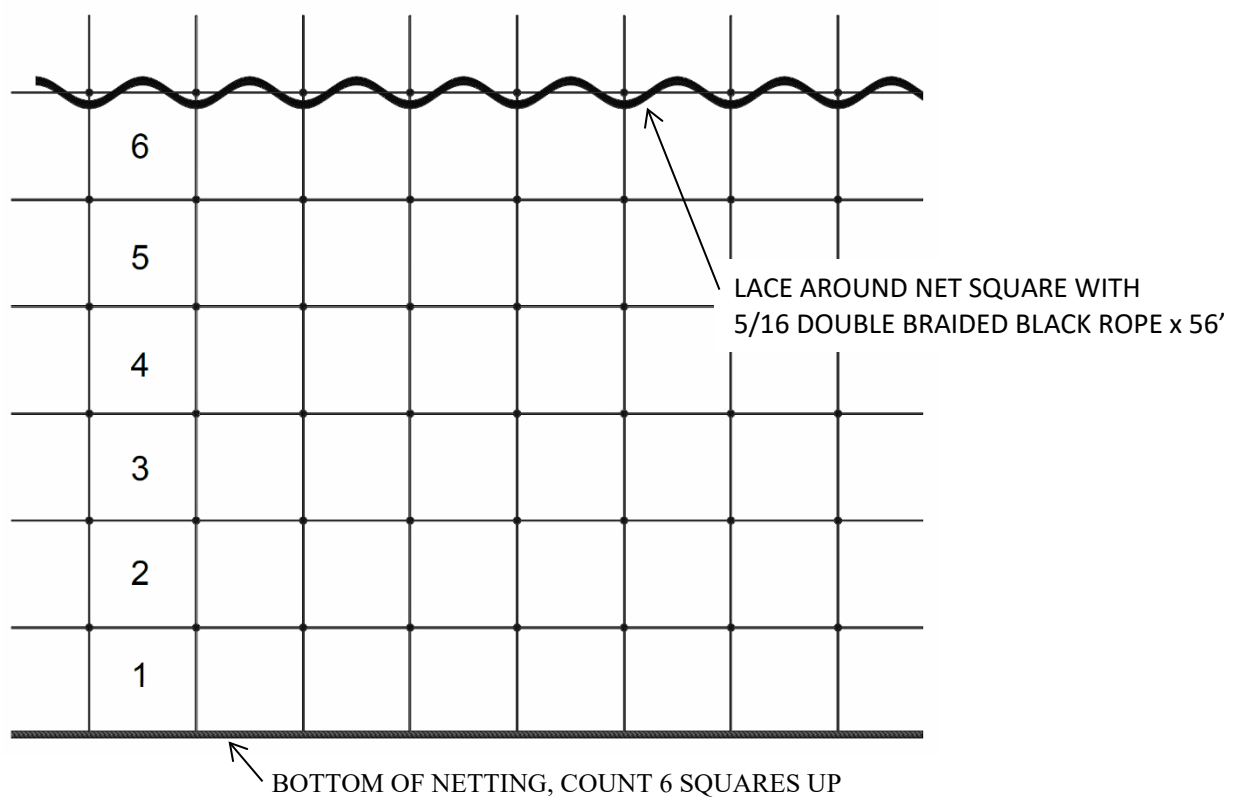
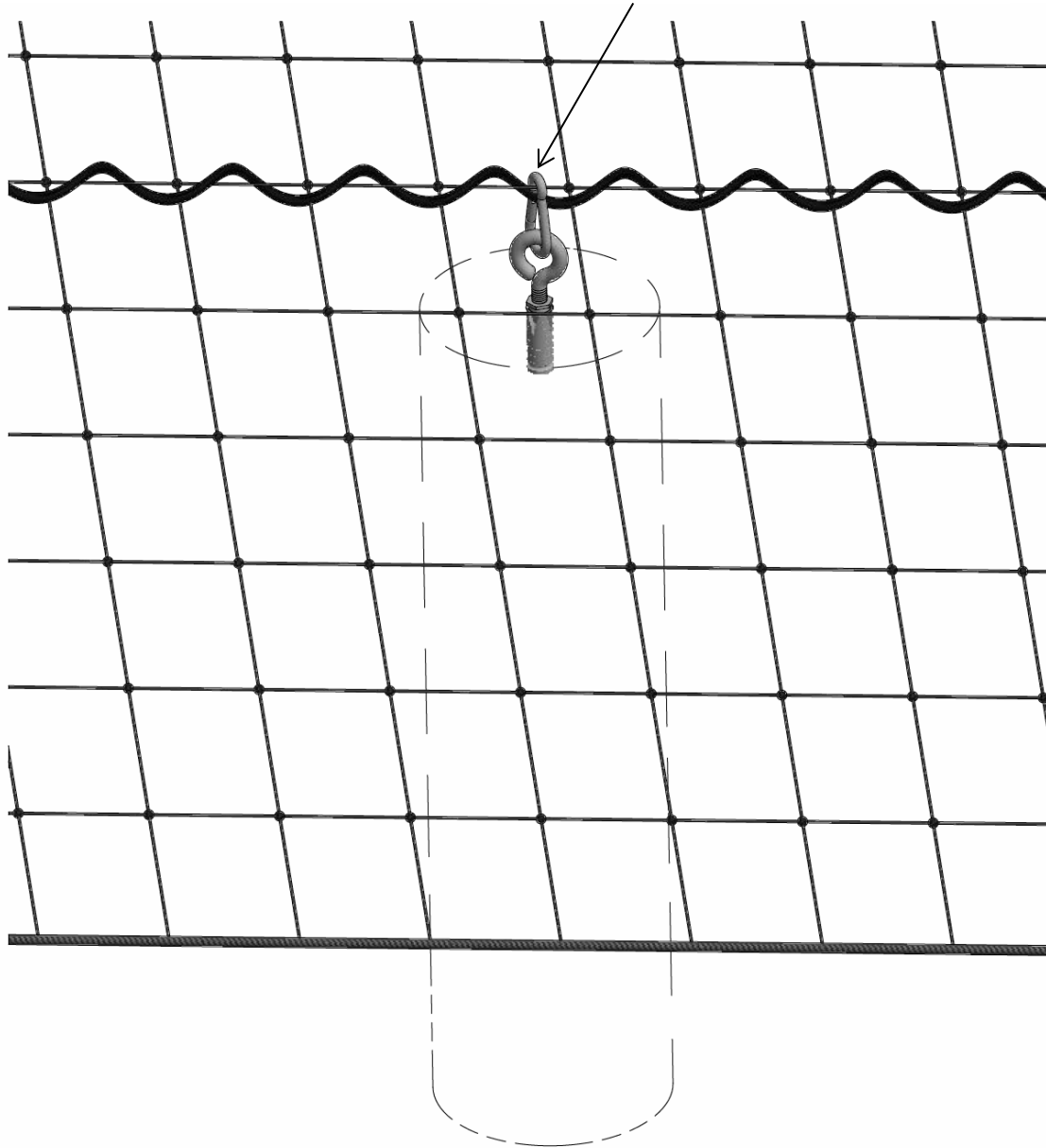

FIGURE: 6 – TYP HOIST END





ATTACHED TO SNAP HOOK  
5/16 DOUBLE BRAIDED BLACK ROPE x 56'



**Maintenance:**

- Before and after each season, thoroughly inspect the net for wear. Repair and holes to prevent them from getting wider.
- Remove all netting before a major storms or extreme winds.