

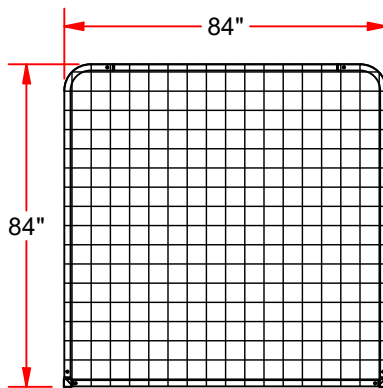

FS-77 COLLEGIATE FIELDERS SCREEN

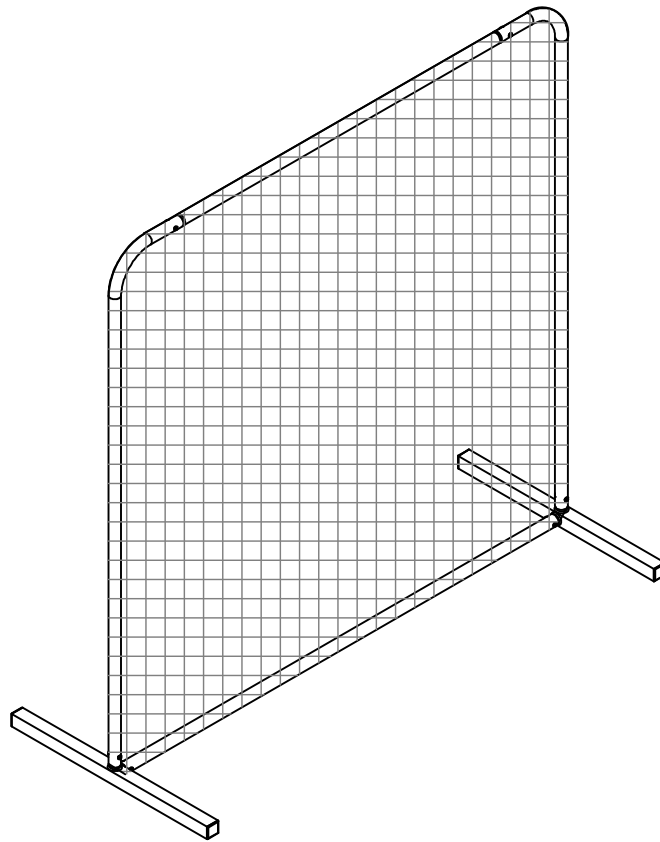

FEATURES:

- > PROVIDES REQUIRED PROTECTION FOR PLAYERS DURING BATTING AND FIELDING PRACTICE
- > 1 5/8" HEAVY GAUGE GALVANIZED STEEL DESIGN
- > 2" SQ. GALVANIZED STEEL LEGS
- > POWDER COATED FOREST GREEN
- > #36 KNOTLESS WEATHERPROOF DOUBLE-SIDED SLIP-ON NET

OPTIONAL EQUIPMENT:

- > REPLACEMENT NET P/N: PS-77N
- > 8" WHEEL KIT FOR EASY TRANSPORTATION P/N: BBWK-2



FS-77

7' x 7' COLLEGIATE FIELDERS SCREEN

© COPYRIGHT 2021 JAYPRO SPORTS, LLC. ALL RIGHTS RESERVED THIS PRINT IS THE PROPERTY OF JAYPRO SPORTS, LLC. AND MAY NOT BE REPRODUCED WITHOUT WRITTEN PERMISSION

www.jaypro.com
(800) 243-0533
976 Hartford Turnpike
Waterford, CT 06385 USA

Sheet 1 of 1