

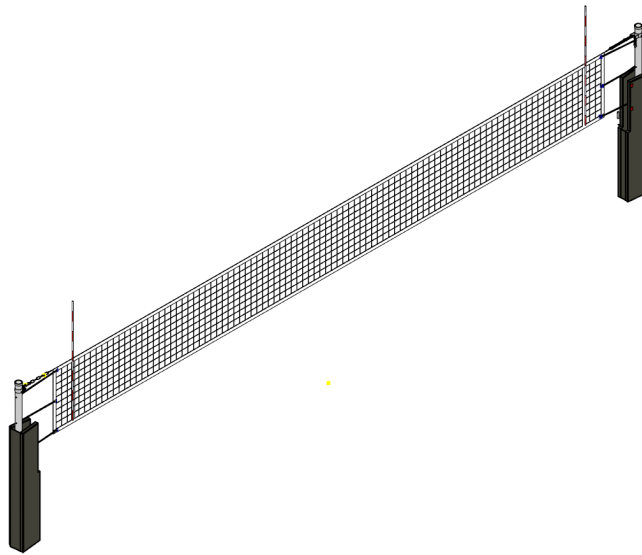

-- PVB-1250 --
Installation Instructions



Call Jaypro Sports Equipment at 1-800-243-0533
during regular business hours for technical support.

www.jaypro.com

PVB-1250

PARTS LIST (QTY: SINGLE UNIT)







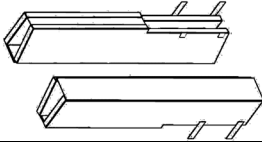

ITEM	IMAGE	DESCRIPTION	QTY
1		COLLEGIATE VOLLEYBALL NET <i>P/N: PVBN-3</i>	1
2		VOLLEYBALL UPRIGHT PADS <i>P/N: PVB-60P</i>	1
3		VOLLEYBALL ANTENNA <i>P/N: VBA-80</i>	1
4		ANCHOR END CLAMP COLLAR <i>P/N: PVB-13-7</i>	1
5		TOP ROLLER CLAMP COLLAR <i>P/N: PVB-13-8</i>	1
6		BOTTOM SLIDING COLLAR <i>P/N: PVB-13-9</i>	2
7		3 1/2" OD UPRIGHT <i>P/N: VB-12U</i>	2
8		WINCH w/ HARDWARE <i>P/N: PVBWINCH</i>	1
9		3/8"-16 x 4 1/4" BUTTON HEX SCREW <i>PART OF PVBWINCH HARDWARE KIT</i>	1
10		3/8" ACORN NUT <i>PART OF PVBWINCH HARDWARE KIT</i>	1
11		3/8" x 4 CARABINER <i>P/N: HM5019</i>	1
12		1/4" x 24" LONG CHAIN <i>P/N: CN0001</i>	1
13		PVC TENSIONING HANDLE <i>PART OF PVBN-3</i>	1
ITEM	IMAGE	DESCRIPTION	QTY

Table of Contents

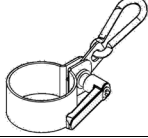
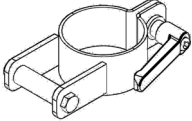
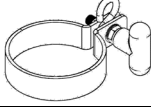
IMPORTANT NOTICE:

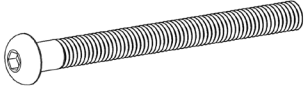
- 1) BEFORE EACH USE CHECK EQUIPMENT FOR PROPER CONNECTING HARDWARE AND STRUCTURAL INTEGRITY. REPLACE DAMAGED OR MISSING HARDWARE IMMEDIATELY.
- 2) NEVER ALLOW ANYONE TO CLIMB OR HANG ON THE NET OR GOAL FRAME. AS SERIOUS INJURY OR DAMAGE TO THE EQUIPMENT MAY OCCUR.
- 3) USE OF THIS EQUIPMENT OTHER THAN INTENDED, MAY BE HAZARDOUS.
- 4) ALTERATION OR MODIFICATION OF THIS EQUIPMENT MAY BE HAZARDOUS AND RESULT IN INJURY. FOR REPAIR OR REPLACEMENT, CONTACT YOUR DEALER OR JAYPRO SPORTS.

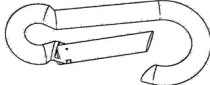
Tools Require:

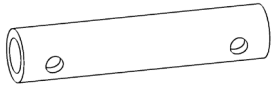
- 1 Adjustable Wench
 - 1 9/16" Box / Socket Wench
 - 1 Tape Measure
- Unpack all parts and check against parts list to ensure that all have been included.
 - Inspect all parts for damage. Report any damages to the trucking company.

These instructions assume that the appropriate ground sleeves have been correctly installed:

- The PVB-1250 will fit most 2" inner diameter ground sleeves.
- The inside bottom surface of the ground sleeves must be at least 8" below floor level.

Please consult the instructions and specifications supplied with your ground sleeves for more information.

If you require additional information or support to install or operate your volleyball system, please contact the Jaypro Sports customer support team, Monday through Friday, 8:30AM to 5:00 PM (EST), at 1-800-243-0533.

Assembly Instructions:

1. Place the uprights onto a table or pair of saw horses and loosely assemble the parts as shown.
2. One upright will be designated the Winch End Upright and the other the Anchor End Upright.
3. Assemble the winch onto one of the uprights as shown.
4. Carefully slide the bottom sliding collar and top roller collar onto the winch end upright. Align the roller collar with winch assembly and tighten.
5. Carefully slide both a bottom sliding collar and anchor end collar over the anchor end upright. Do not over tighten the clamping bolts as further adjustment will be required.
6. Place uprights in preinstalled sleeves (see instructions included with sleeves for their installation).
7. Adjust the heights of the collars to the specific activity to be played. The top edge of the top collars should be placed about $\frac{3}{4}$ " above the desired height of the net. The bottom collars should be positioned about 39" below the top collars.
8. Ensure both side dowels are inserted in the side net binding. Position the net between the 2 uprights.
9. Thread the webbing strap from the winch over the roller clamp and connect the end of the cable to the snap buckle. Connect the other end of the net to a carabiner and the length of chain provided and attach that end of the chain to the top anchor end clamp (step 5) with the other carabiner.
10. Adjust the length of the chain as necessary to center net on court.
11. Slowly tension the top webbing strap by cranking the winch with the winch handle. Adjust chain as necessary to keep the net centered.
12. Verify net heights and net centering. The uprights will deflect inward and downward due to net tension; you may need to adjust heights and /or re-center the net.

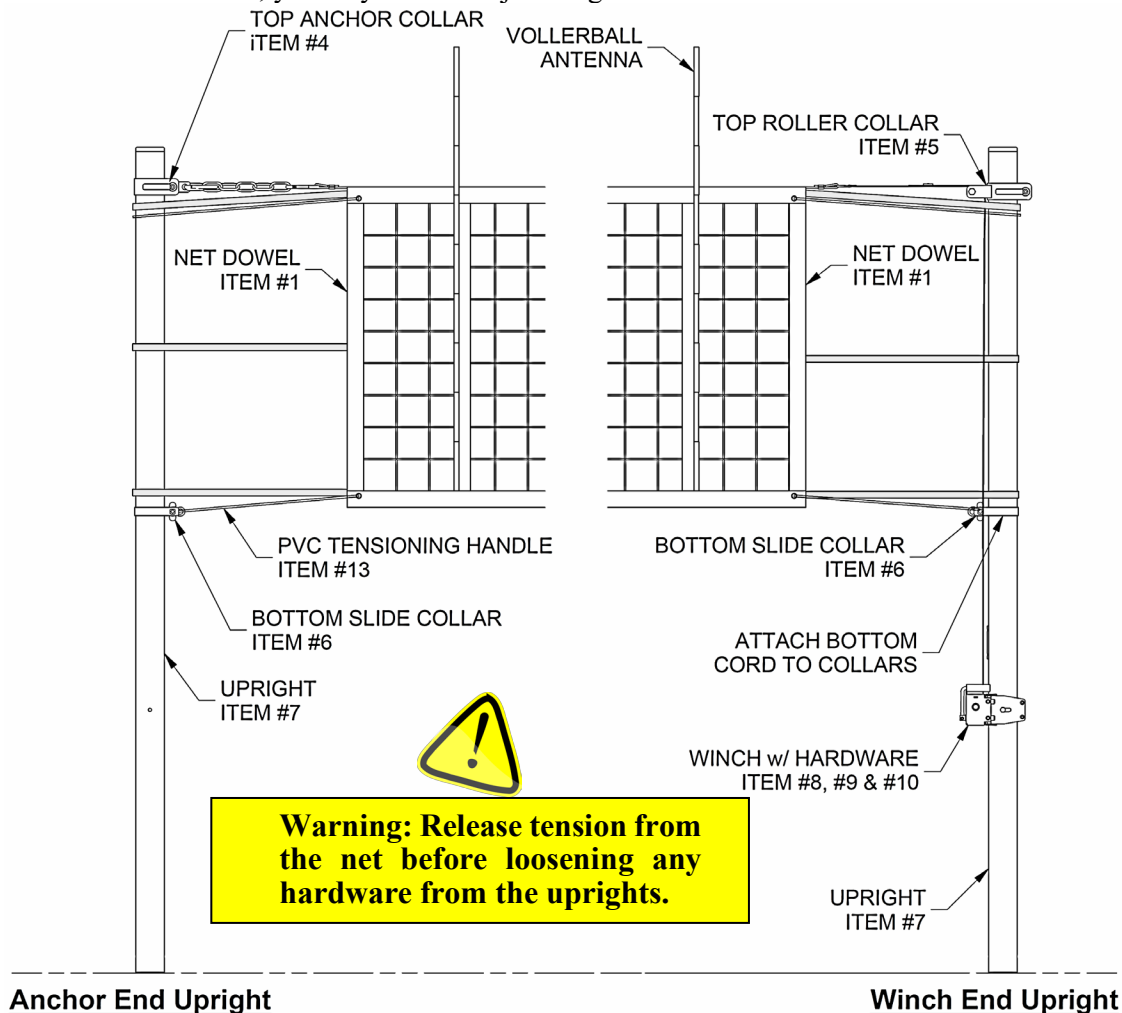

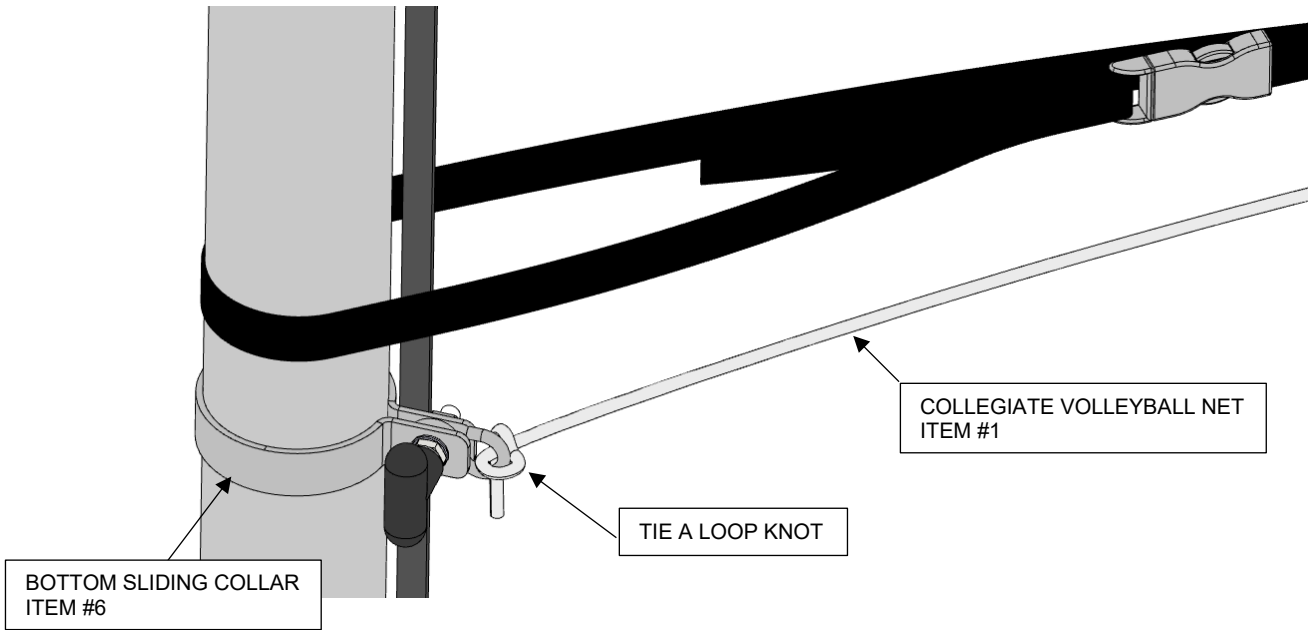

Winch End Upright

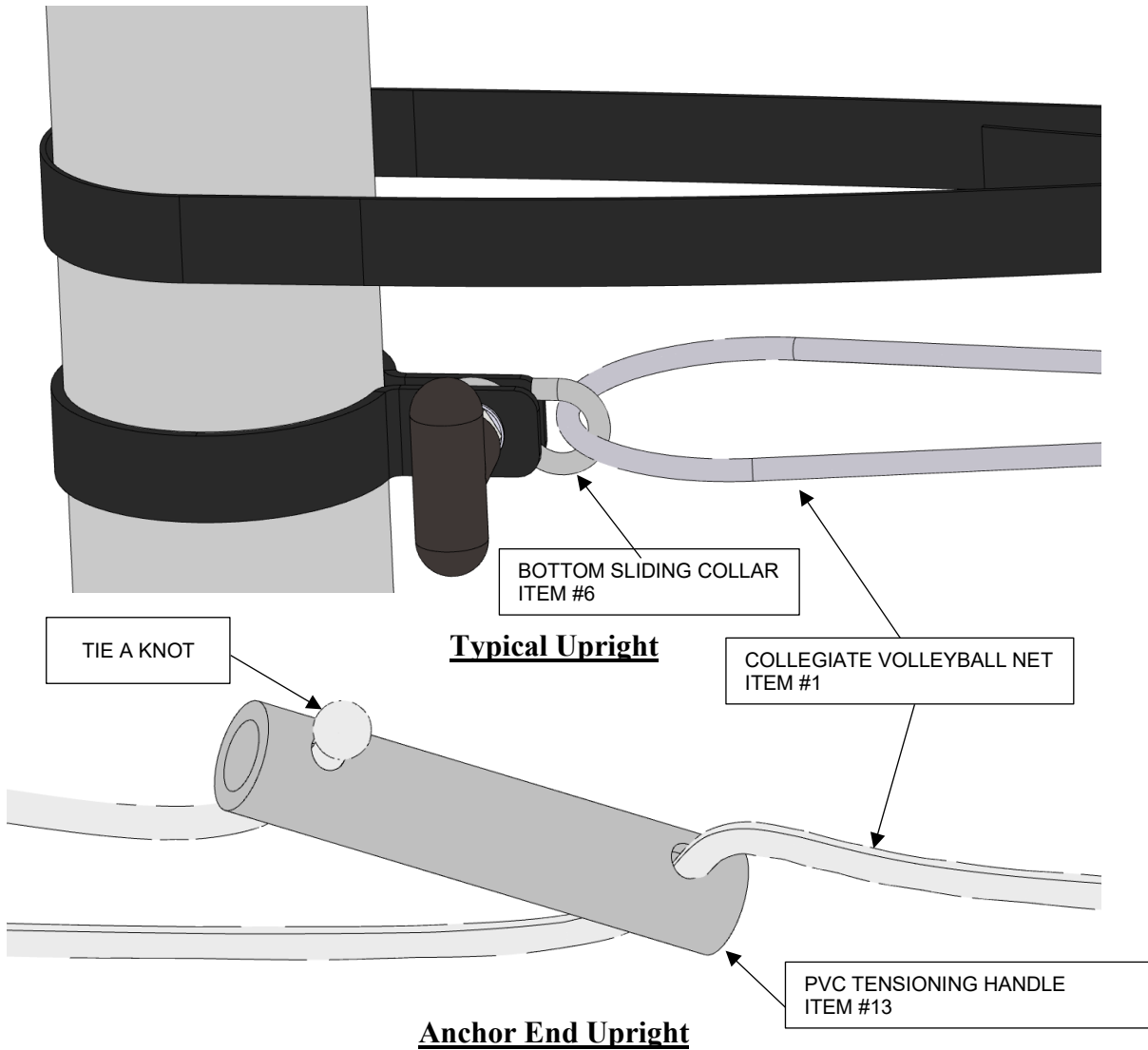

Typical Upright

Anchor End Upright

Assembly Instructions:

13. Raise the center of the net to the full official net height by cranking the handle. Adjust all net side straps to further tension the net.
14. When releasing tension on the net, first unfasten the side straps and release tension on the bottom cord, and then slowly release tension of the top cable.
15. To remove the unit for storage, disconnect the net from the 2 uprights and carefully lift each upright from the floor sleeve.
16. For player safety cut any excess chain before putting system into service.

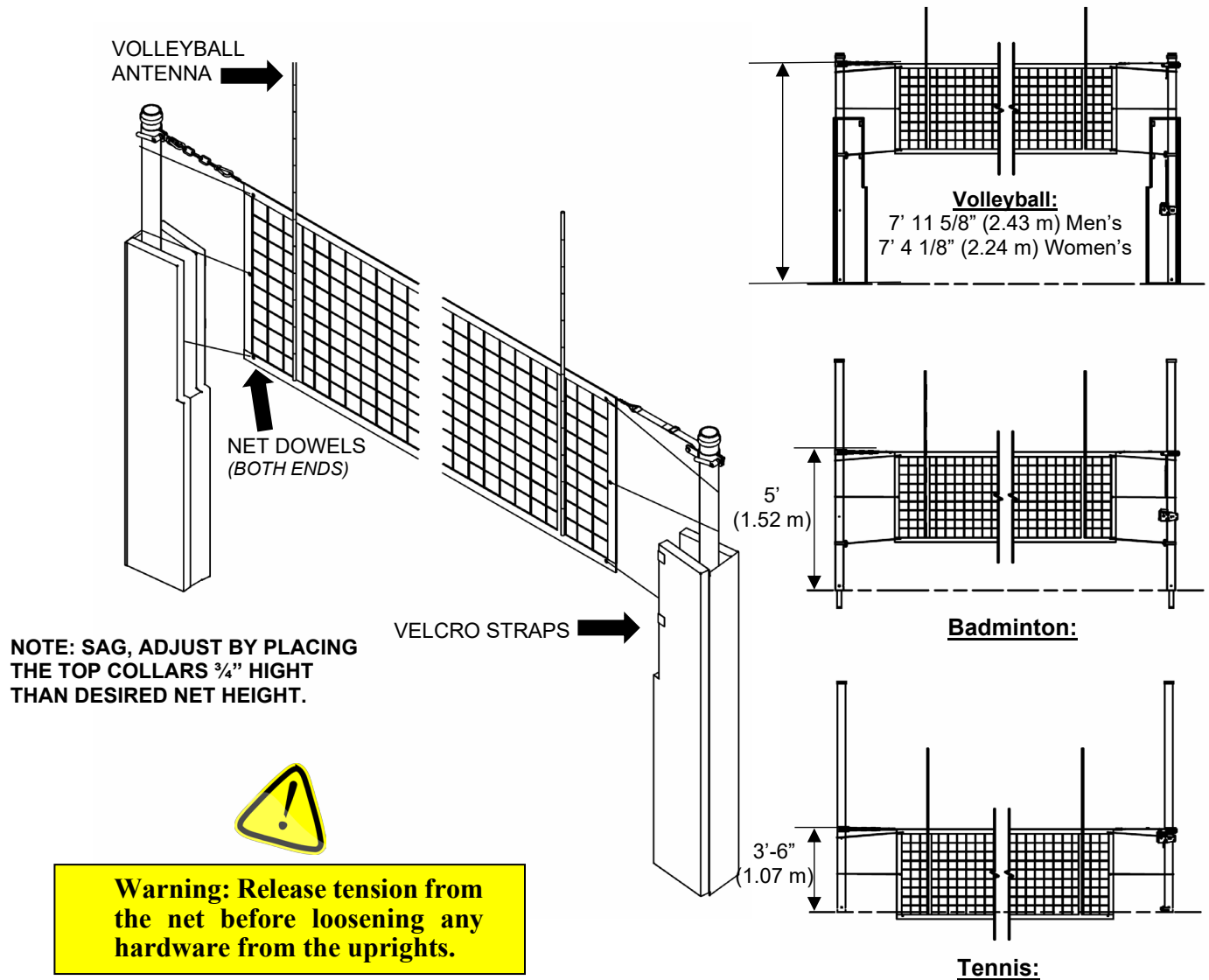

INSTALLATION AND USE CONSIDERATIONS

- 1) The unit is designed for high level competition play. Consequently, when installed and operational, the unit is subject to considerable stress loads. It is essential to inspect all parts before each use.
- 2) Do not use this equipment without the protective upright padding properly fastened in place.