

# Charging Cart Instructions

03/30/17

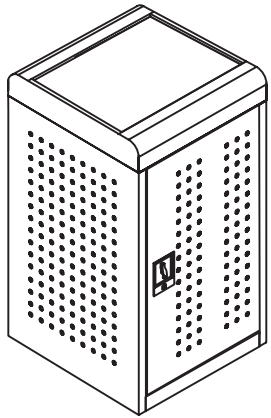

**A** x1

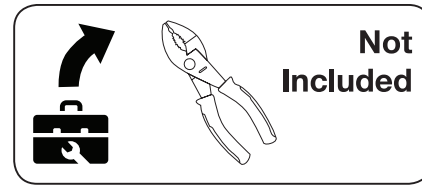
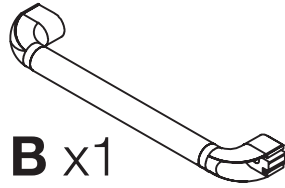

**B** x1



**C** x2



**D** x1

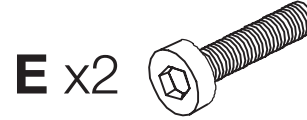

**E** x2

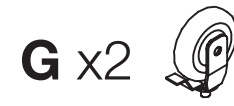

**G** x2



**F** x1

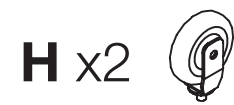

**H** x2



**J** x1



**K** x1



**L** x2

**1**

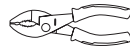
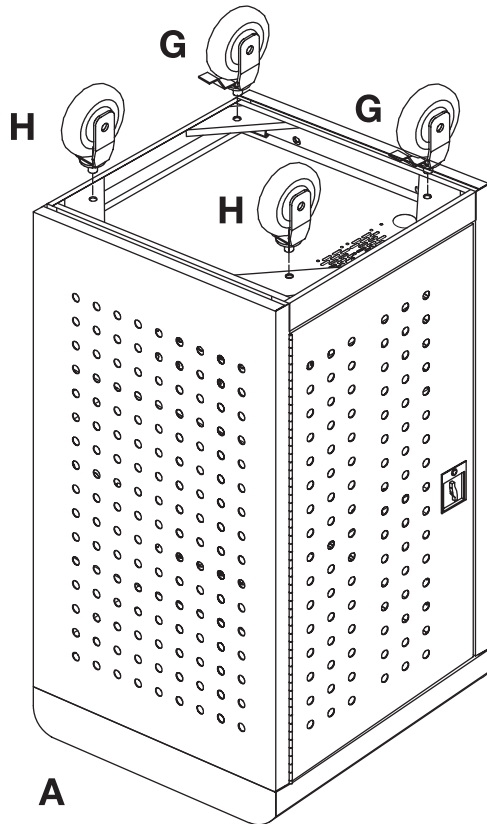

Heavy Lifting:  
Assistance  
Required

**2**

