

INSTRUCTIONS - MOBILE CLASS BOARD

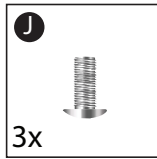

STEP 1

Note the orientation markings for the holes

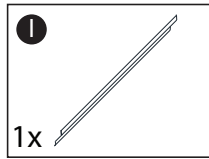
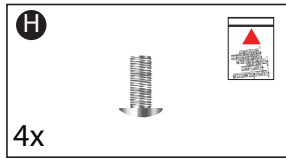
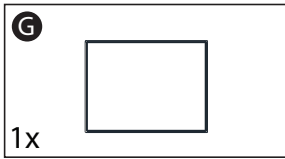
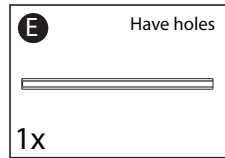
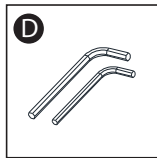
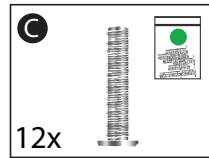
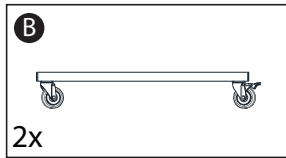
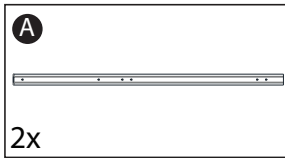
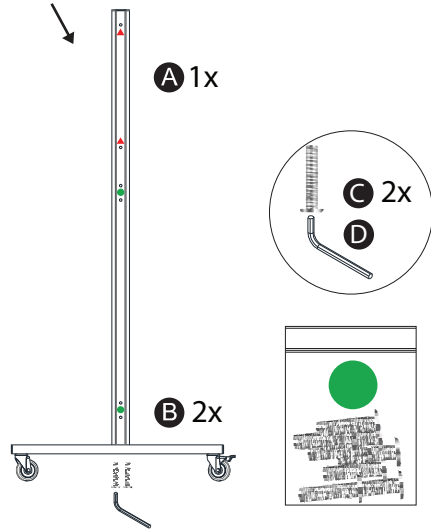

STEP 2

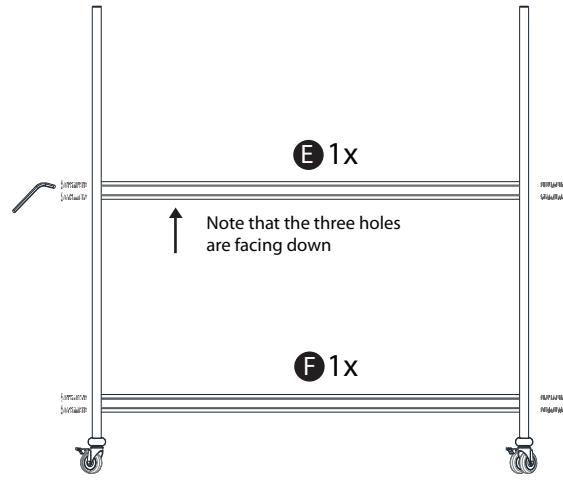

Two people together to complete

STEP 3

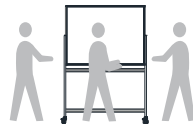
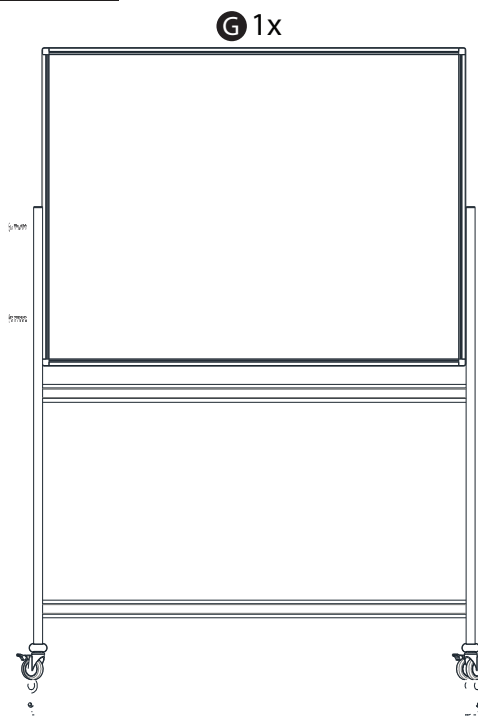

Three people together to complete

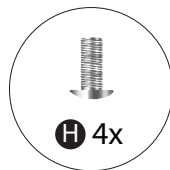

STEP 4

