

15" Wide See Through Lockers – S-52000 Series

Double Tier Installation Instructions

Thank you for selecting Salsbury's 15" wide see through double tier lockers. These instructions are intended to assist you in assembling the lockers. Assembly of the various locker components will be with #10 - 24 x 3/8" long slot less screws and #10 nuts (provided). Loosely fasten a screw and a nut into every set of mating holes with the screw heads positioned on the outside of the locker or on the exposed surface.

One Wide Locker Assembly

Step 1: Attach the top shelf, bottom shelf, and two single coat hooks to the back panel.

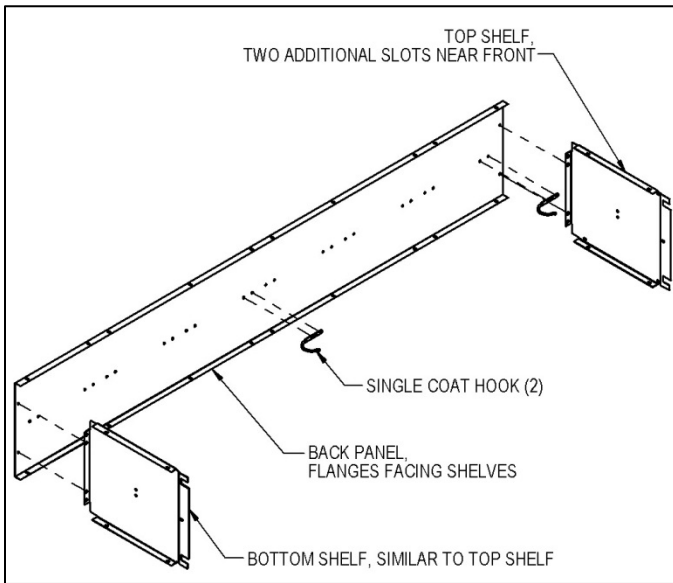

Step 2: Turn the back panel on its back with the shelves pointing upward. Attach the first side panel, the left rear leg, and one compartment divider to the assembly from Step 1. Attach an additional two single coat hooks to the first side panel and a double coat hook to the bottom of the top shelf and a second double coat hook to the bottom of the compartment divider.

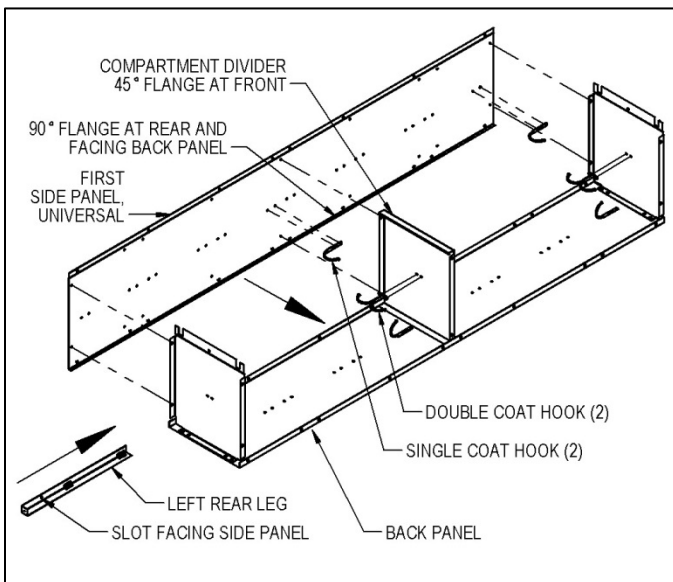

Step 3: Attach the second side panel and the right rear leg to the assembly of Step 2. Attach an additional two single coat hooks to the second side panel. The locker chassis is now complete.

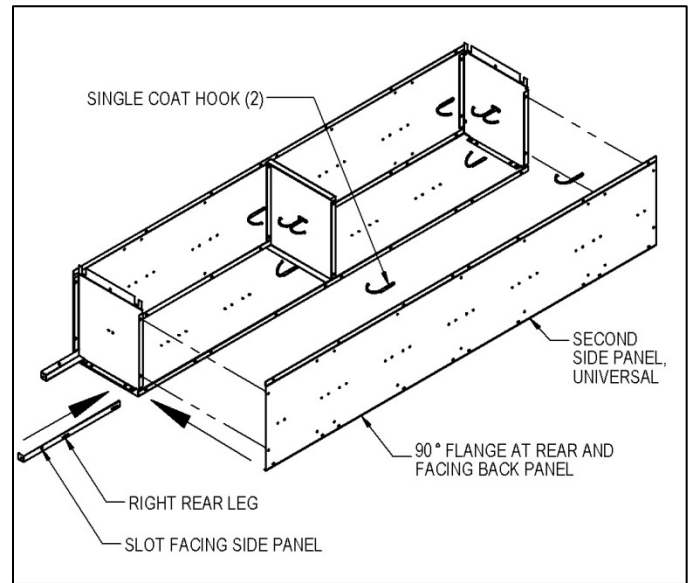

Step 4: Attach the pre-assembled door frame onto the assembly of Step 3.

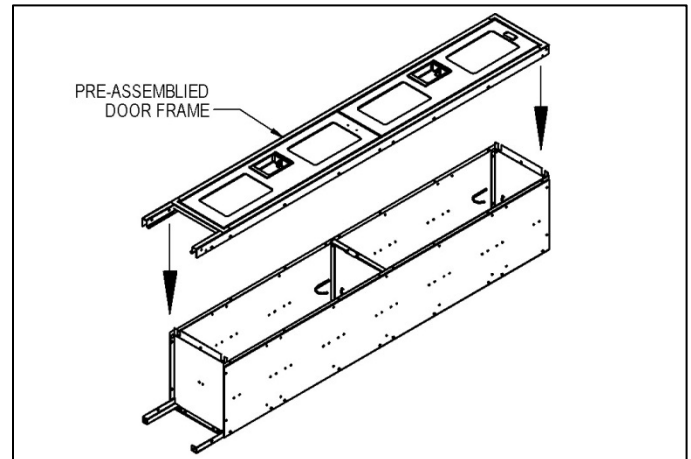

Step 5: Tighten all fasteners checking for squareness of the locker while tightening. Attach optional sloping hood, end bases or front base (see pages 4 and 5).

Step 6: Place the locker in the installed location and anchor to the floor, wall, or to both. Individual job conditions will dictate the type of fastening anchors to use (not provided).

Step 7: Fasten all lockers in a row together by installing fasteners provided through the side panels. Installation is now complete.

Phone: 1-800-562-5377
 Fax: 1-800-562-5399
 www.lockers.com

SALSBURY INDUSTRIES
 18300 Central Avenue, Carson, CA 90746-4008

Int'l Phone: 323-846-6700
 Int'l Fax: 323-846-6800
 engineering@lockers.com

15" Wide See Through Lockers – S-52000 Series Double Tier Installation Instructions

Three Wide Locker Assembly

Step 1: Attach the top shelf, bottom shelf, and two single coat hooks to the back panel.

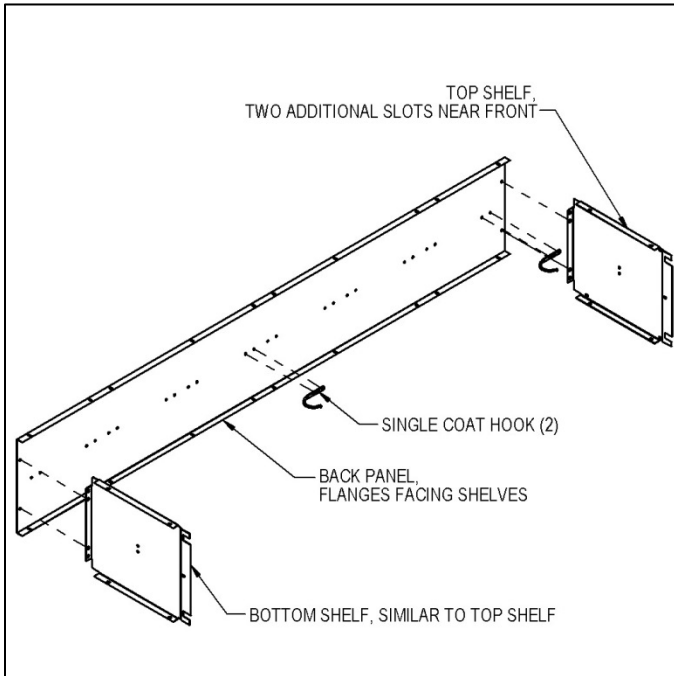

Step 2: Turn the back panel on its back with the shelves pointing upward. Attach the first side panel, the left rear leg, and one compartment divider to the assembly from Step 1. Attach an additional two single coat hooks to the first side panel and a double coat hook to the bottom of the top shelf and a second double coat hook to the bottom of the compartment divider.

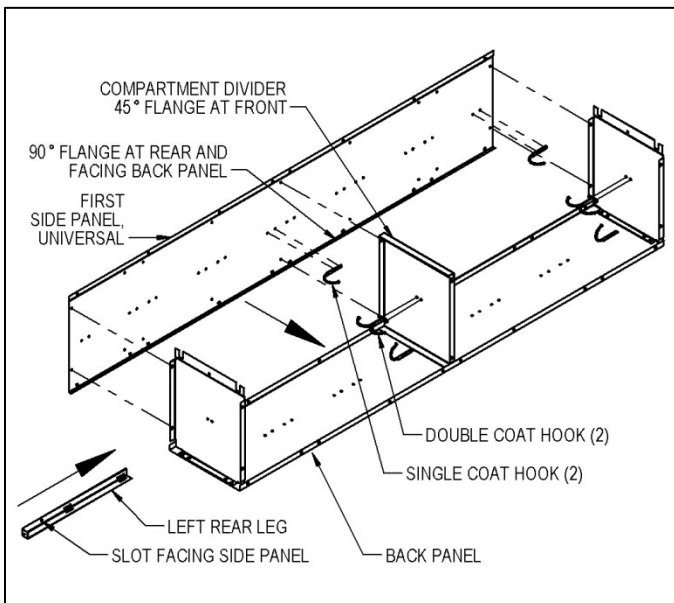

Step 3: Attach the second top shelf, the second bottom shelf, and an additional two single coat hooks to the second back panel as in step 1.

Step 4: Simultaneously attach the assembly of Step 3 (second Step 1 assembly), the second side panel, and one additional compartment divider to the assembly of Step 2. Attach two coat hooks to each side of the second side panel, and attach two double coat hooks to the assembly of step 3.

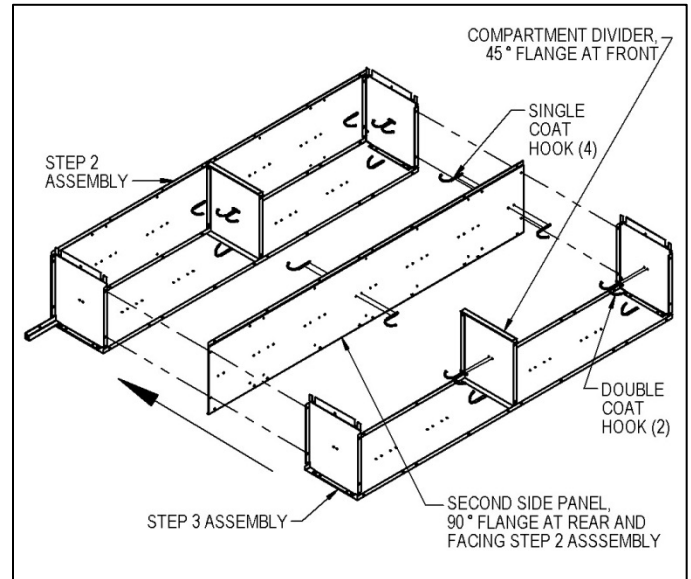

Step 5: Attach the third top shelf, the third bottom shelf, and an additional two coat hooks to the third back panel as in steps 1 and 3.

Step 6: Simultaneously attach the assembly of Step 5 (third Step 1 assembly), the third side panel, and one additional compartment divider to the assembly of Step 4. Attach two coat hooks to each side of the third side panel, and attach two double coat hooks to the assembly of step 5.

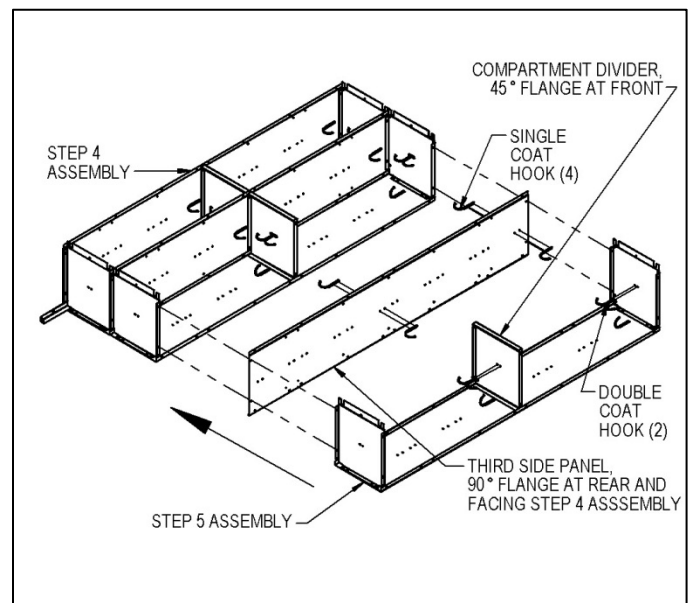

Phone: 1-800-562-5377
Fax: 1-800-562-5399
www.lockers.com

SALSBURY INDUSTRIES
18300 Central Avenue, Carson, CA 90746-4008

Int'l Phone: 323-846-6700
Int'l Fax: 323-846-6800
engineering@lockers.com

15" Wide See Through Lockers – S-52000 Series Double Tier Installation Instructions

Three Wide Locker Assembly (continued)

Step 7: Attach the last side panel and the right rear leg to the assembly of Step 6. Attach two additional single coat hooks to the last side panel. The locker chassis is now complete.

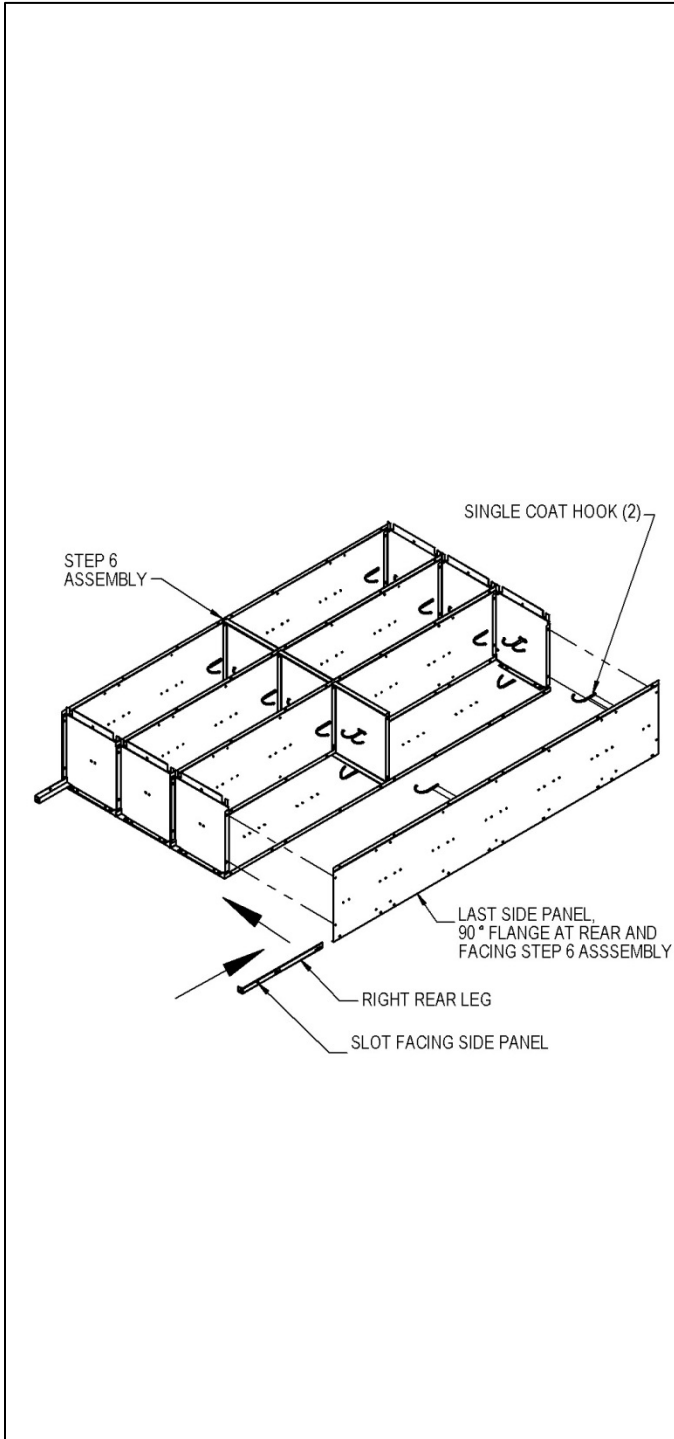

Step 8: Position the pre-assembled door frames onto the assembly of Step 7 then fasten one by one.

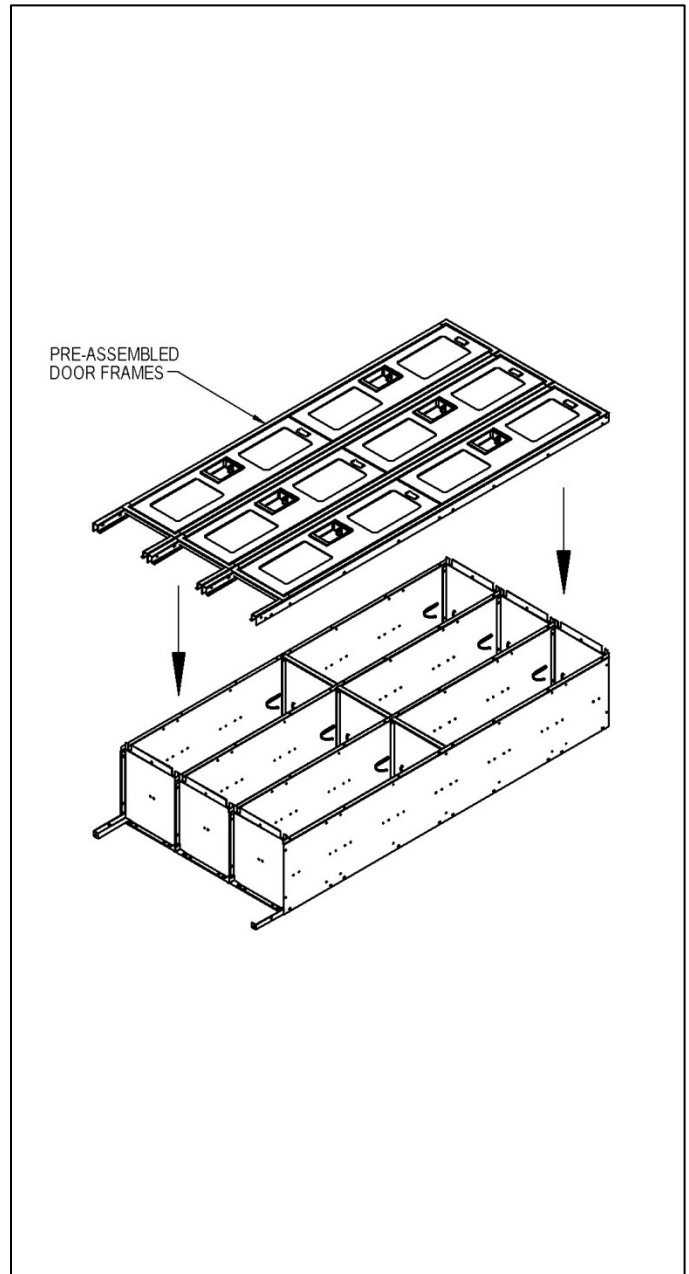

Step 9: Tighten all fasteners checking for squareness of the locker while tightening. Attach optional sloping hoods, end bases or front bases (see pages 4 and 5).

Step 10: Place the locker in the installed location and anchor to the floor, wall, or to both. Individual job conditions will dictate the type of fastening anchors to use (not provided).

Step 11: Fasten all lockers in a row together by installing fasteners (provided) through the side panels. Installation is now complete.

Phone: 1-800-562-5377
Fax: 1-800-562-5399
www.lockers.com

SALSBURY INDUSTRIES
18300 Central Avenue, Carson, CA 90746-4008

Int'l Phone: 323-846-6700
Int'l Fax: 323-846-6800
engineering@lockers.com

15" Wide See Through Lockers – S-52000 Series Double Tier Installation Instructions

Sloping Hood Installation (Optional)

Step 1: Assemble the top panel to the rear panel with #10 - 24 x 3/8" slot less screws and #10 nuts (provided). Position the flange of the top panel behind the rear panel.

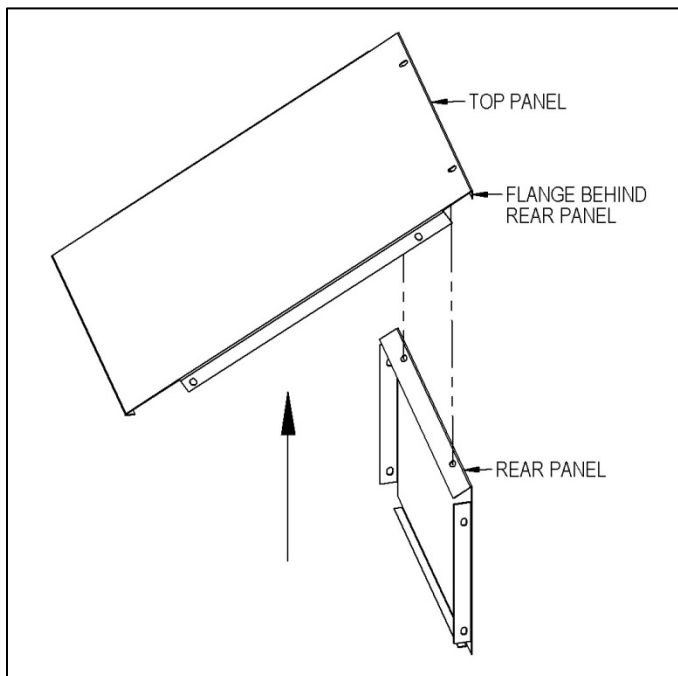

Step 2: Assemble the side panels to the top panel and rear panel with #10 - 24 x 3/8" long slot less screws and #10 nuts (provided).

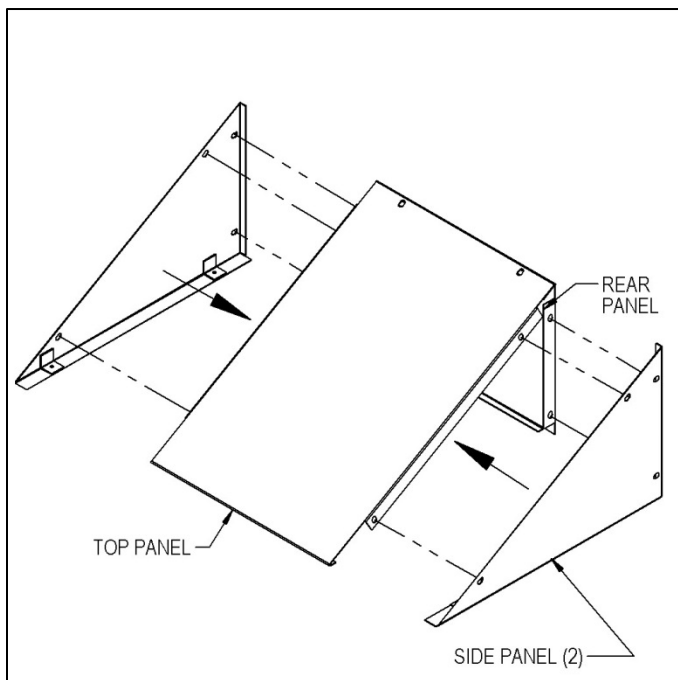

Step 3: Attach the sloping hood to the top of the locker with #10 - 24 x 3/8" slot less screws and #10 nuts (provided).

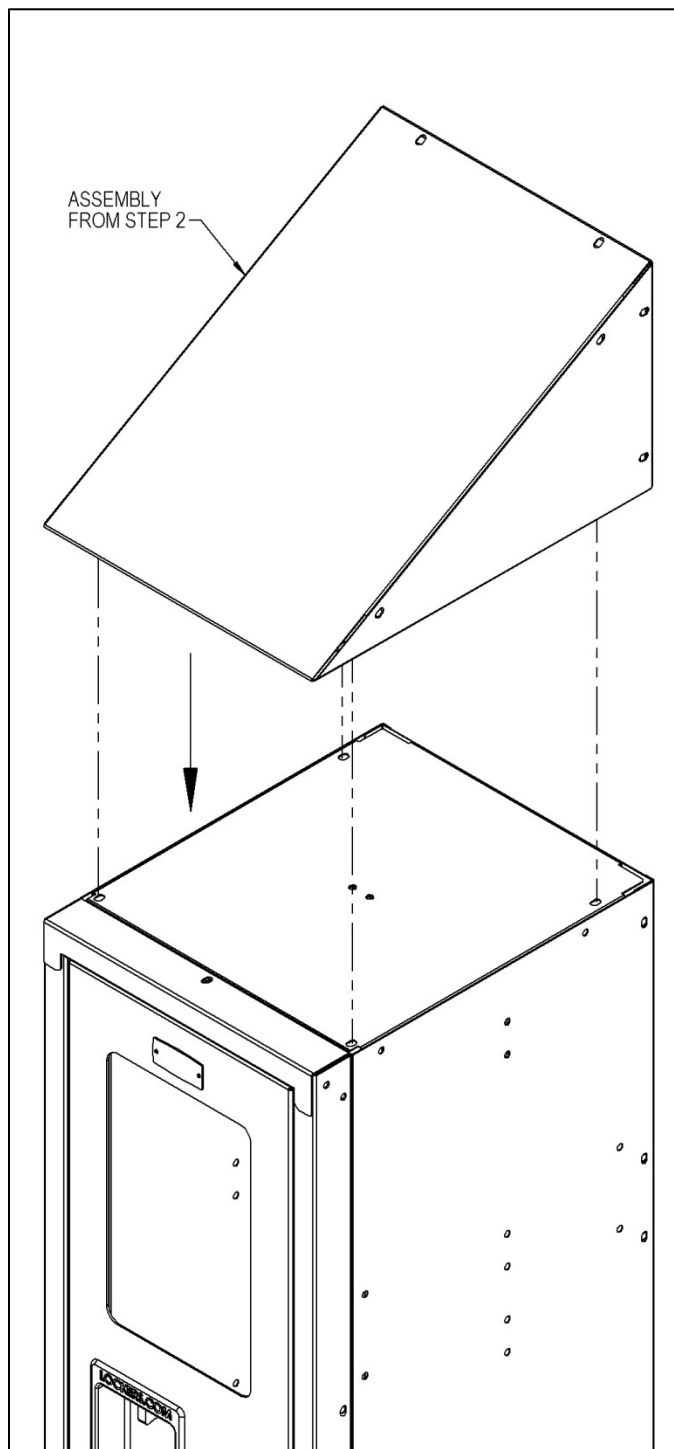

Phone: 1-800-562-5377
Fax: 1-800-562-5399
www.lockers.com

SALSBURY INDUSTRIES
18300 Central Avenue, Carson, CA 90746-4008

Int'l Phone: 323-846-6700
Int'l Fax: 323-846-6800
engineering@lockers.com

15" Wide See Through Lockers – S-52000 Series Double Tier Installation Instructions

Front Base Installation (Optional)

Position the front base between the front legs of the locker with the flange upward. Assemble to the locker with #10 - 24 x 3/8" slot less screws and #10 nuts (provided).

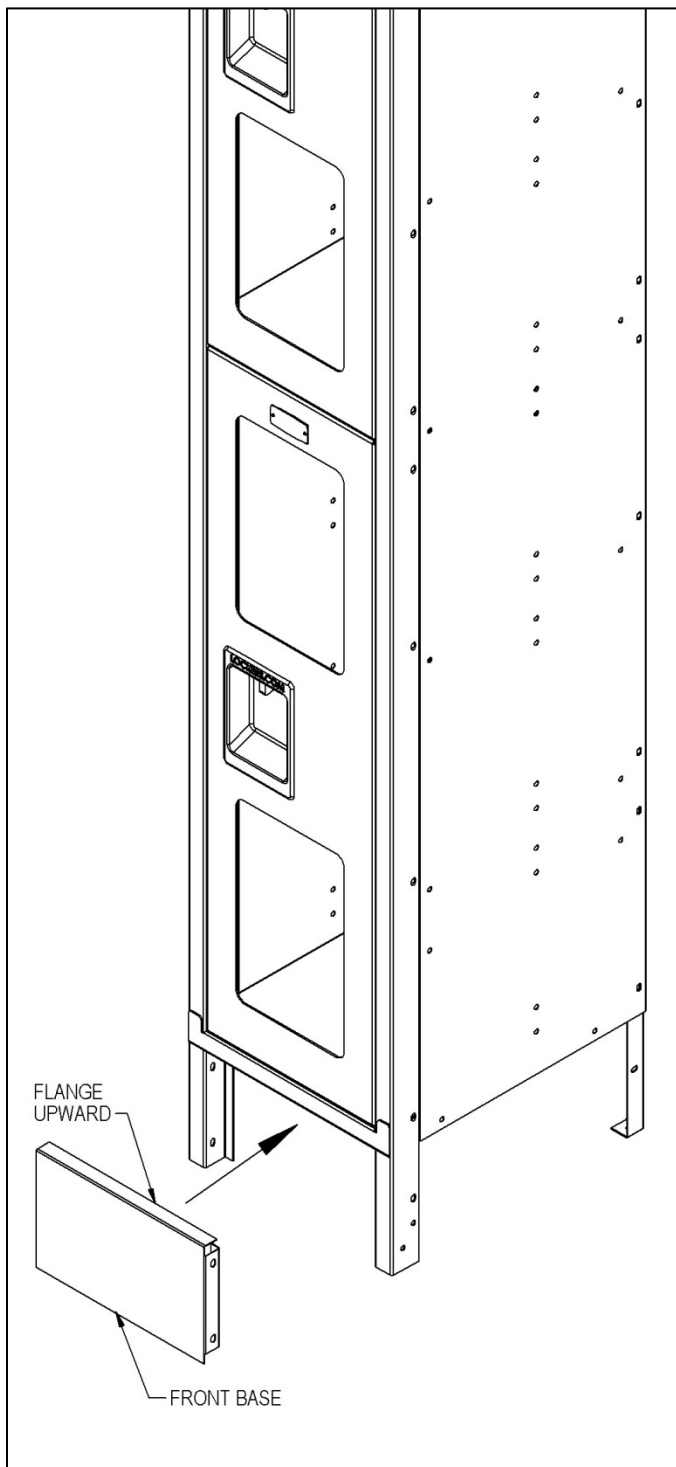

End Base Installation (Optional)

Position the appropriate end base (right or left) behind the corresponding side legs (right or left) of the locker with the flange upward. Assemble to the locker with #10 - 24 x 3/8" slot less screws and #10 nuts (provided). Repeat for the other side.

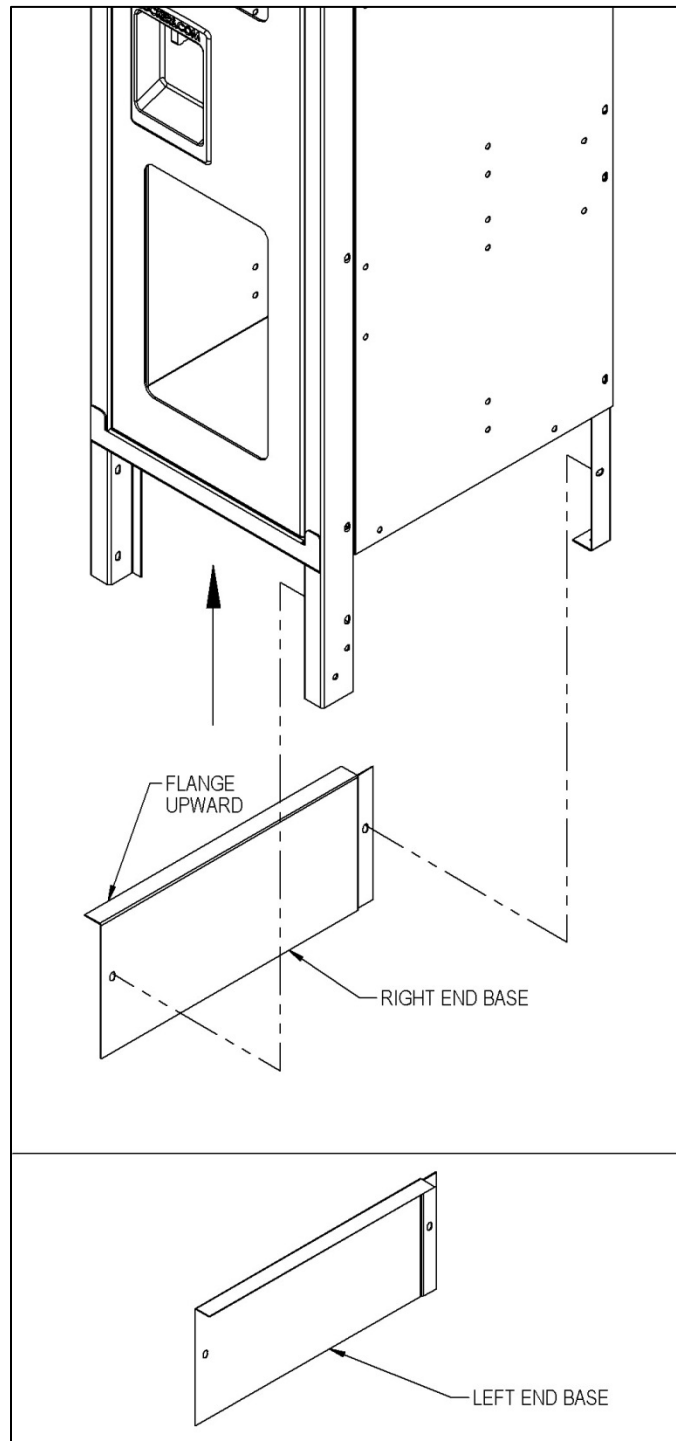

Phone: 1-800-562-5377
Fax: 1-800-562-5399
www.lockers.com

SALSBURY INDUSTRIES
18300 Central Avenue, Carson, CA 90746-4008

Int'l Phone: 323-846-6700
Int'l Fax: 323-846-6800
engineering@lockers.com