

# VAC FILL™

*The most economical unit to Evacuate,  
Leak Test & Refill Engine Cooling System!*

**Powered by the award-winning AIRLIFT™ Technology!**



UView Ultraviolet Systems Inc.  
1324 Blundell Road, Mississauga,  
Ontario Canada L4Y 1M5  
Toll Free: 1 (877) 776-8486  
Phone: 1 (905) 615-8620  
Fax: 1 (905) 615-9745

Email: [sales@uview.com](mailto:sales@uview.com)  
[www.uview.com](http://www.uview.com)

# VAC FILL™

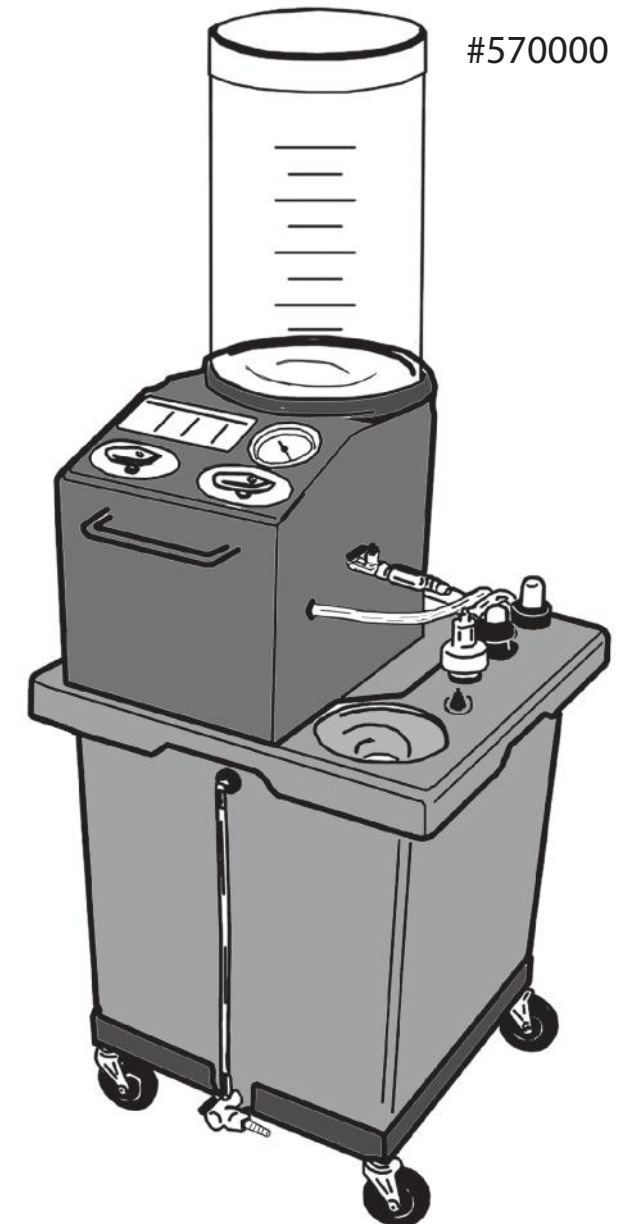

## INDEX

CONTROL LOCATIONS.....	1
REMOVE COOLANT FROM AN OPEN COOLING SYSTEM .....	2
REMOVE COOLANT FROM A HOT SYSTEM .....	3
DRAFT EFFECT PROCEDURE .....	4
REMOVE COOLANT FROM OVERFLOW TANK .....	4
EVACUATE AIR FROM COOLING SYSTEM .....	5
TEST VACUUM .....	5
FILL NEW COOLANT INTO COOLING SYSTEM .....	6
STOP FILLING COOLANT .....	6
DRAIN TO RESERVOIR TANK .....	7
REUSE COOLANT .....	7
REPLACEMENT & ADD ON PARTS.....	8

### ENGINE COOLING



**WARNING!**



- Hot antifreeze/coolant under pressure.  
Wear safety shield and protective clothing (user and bystanders).  
Do not open system when hot.  
Read and follow instructions.  
Hot, pressurized antifreeze/coolant can cause injury.



- Moving engine components.  
Wear safety goggles (user and bystanders).  
Keep self and tools clear of moving parts.  
Moving components can cause injury.



- Engine exhaust contains toxic gases.  
Vent exhaust away from work area.  
Do not breathe exhaust.  
Exhaust gases can cause injury.

### WARRANTY

*UView Ultraviolet Systems Inc. warrants its products to be free of defects in materials and workmanship for a period of one Year.*

*UView Ultraviolet Systems Inc., at its sole discretion, will replace or repair any defective item within the Warranty period. UView Ultraviolet Systems Inc. must be contacted in the event of a warranty claim and UView Ultraviolet Systems Inc., at its sole discretion, will decide if the item needs to be returned for inspection. If the item is to be returned for inspection, a Returned Goods Authorization Number (RGA) and shipping instructions will be provided. All returns must be clearly marked with the RGA number provided.*

*UView Ultraviolet Systems Inc. products can normally be serviced “in field” and will not require return. A replacement part can be sent from the Factory for such repair.*

*Please contact our Customer Service Department.*

*Toll Free: 1 (877) 776-8486*

# REPLACEMENT PARTS

## PARTS for FILL TANK

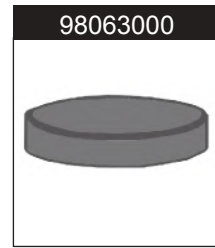

FILL TANK COVER



FILL TANK FILTER

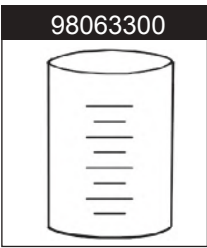

FILL TANK

## ADAPTERS/STOPPERS



RUBBER ADAPTERS (4)

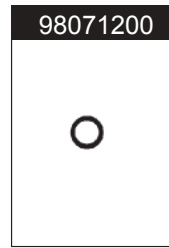

RING STOPPER

## MISCELLANEOUS PARTS

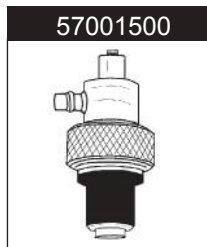

RAD NECK

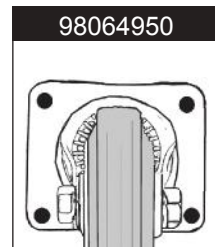

WHEEL

## EXTENSION TUBE ASSEMBLY

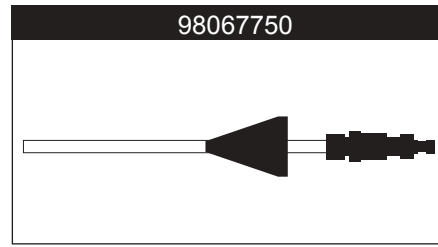

98067750

## OPTIONAL ADD-ON

### REUSE COOLANT FILTER

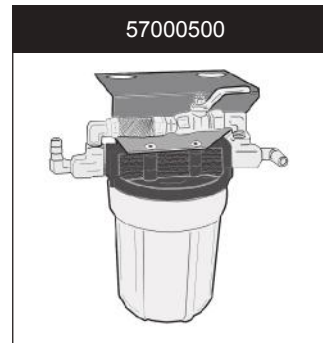

57000500

# CONTROL LOCATIONS

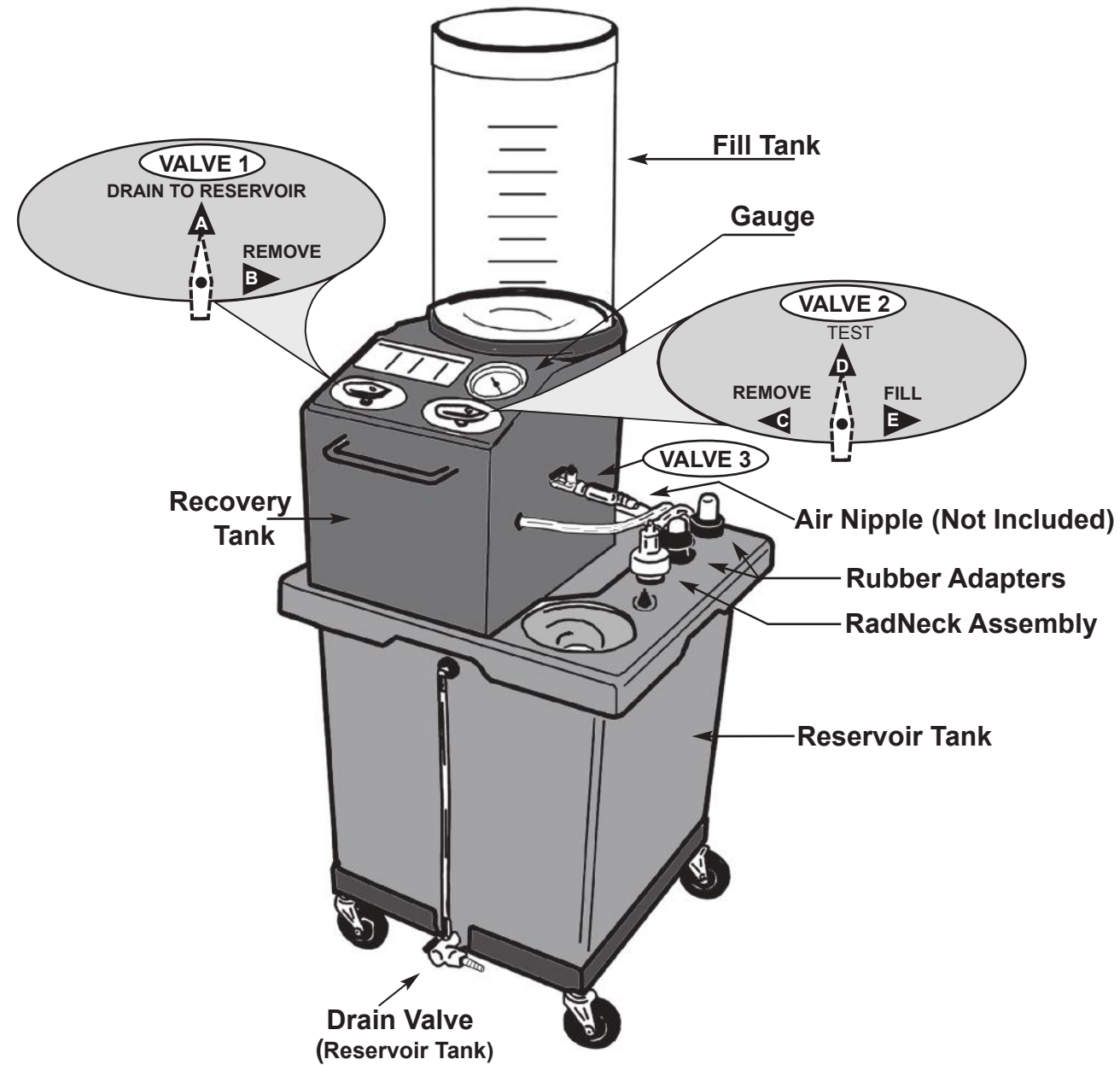

## REMOVE COOLANT FROM AN OPEN COOLING SYSTEM

- For faster coolant removal, preheat vehicle's cooling system until it reaches Operating Temperature (minimum 140 °F/60 °C) with Radiator Cap or Side Pressurized Tank Cap off.
- Disconnect RadNeck Assembly from extraction hose. For all horizontal / vertical radiators and side tanks, an Extension Tube Assembly (rigid 3/8" O.D. with Cone) must be added to the extraction hose to remove coolant (when applicable). Place Extension Tube Assembly into radiator or side tank until it reaches the bottom. If tube does not reach bottom of the tank, then slide Cone up or down until it reaches the bottom. ( **Figure 1** )
- Connect Air Line (minimum 90 PSI) to Air Valve on unit. Air Valve must be "OFF". ( **Figure 2** )  
**NOTE:** Clamp off any overflow hoses to get maximum vacuum. **Air Nipple not included.**
- Attach extraction hose to Extension Tube Assembly or RadNeck Assembly to radiator opening or side tank using the appropriate rubber adaptor, tighten the knurl body by turning it clockwise until snug to ensure fit to radiator neck (only for RadNeck Assembly). ( **Figure 3** )

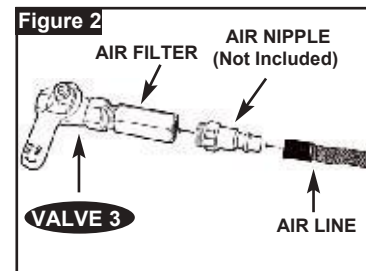
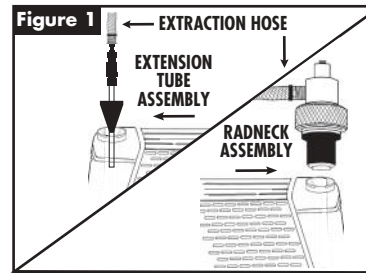

- Set **VALVE 1** to **B** "REMOVE" and **VALVE 2** to **C** "REMOVE" and **VALVE 3** to "ON" .

**NOTE:** There will be a hissing sound from the Coolant Changer system and the radiator hose may start to collapse - this is normal due to vacuum draw. On some vehicles, the ignition must be on and the heater set on high.

- Push down only on Extension Tube Assembly until vacuum gauge starts to climb to secure cone in place.
- After 3 minutes, start vehicle for 5 seconds to help remove any coolant in the engine block.
- Removal is completed when there is no coolant flow in the RadNeck assembly extraction hose. ( **5 minutes** )
- Set **VALVE 2** to **D** "TEST" and **VALVE 3** to "OFF" .

**NOTE:** It is important to follow the above steps in the exact order.

If **VALVE 3** is turned "OFF" before **VALVE 2** is in **D** "TEST" position, coolant will flow back into the vehicle.

- To release vacuum in system for repairs, disconnect coupler on extraction hose from Extension Tube assembly or RadNeck Assembly. ( **Figure 4** )
- When as much coolant as possible is removed using the above procedure, additional coolant can be removed using "Draft Effect" instructions on page 4.

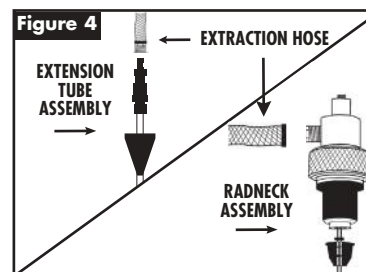
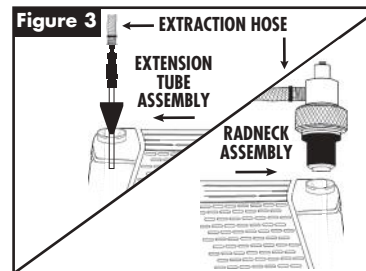

## TO DRAIN TO RESERVOIR TANK

- Set **VALVE 3** to "OFF" .
- Set **VALVE 1** to **A** "DRAIN TO RESERVOIR" and **VALVE 2** to **D** "TEST" to drain removed coolant from Recovery Tank to Reservoir Tank.
- Let coolant continue to drain until Recovery Tank is empty or Reservoir Tank is full. This will take approximately 5 minutes for 2.5 gallons (9.5 L).
- Set **VALVE 1** to **B** "REMOVE" position to stop draining.

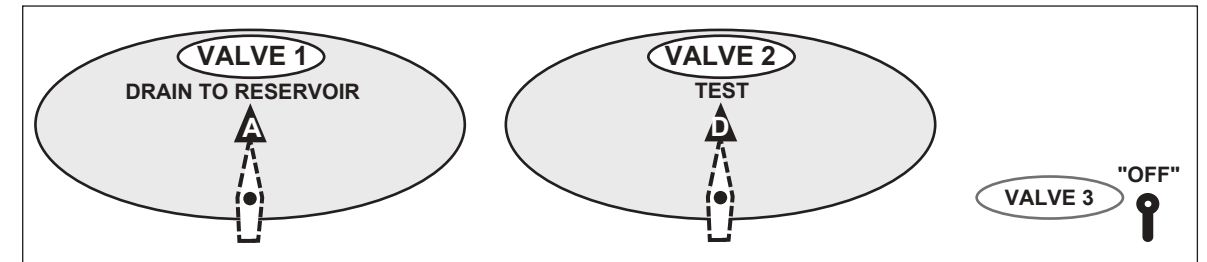

## TO REUSE COOLANT

- Cooling System must be in vacuum. See "EVACUATE AIR" instructions.
- Set **VALVE 3** to "OFF" .
- Set **VALVE 1** to **B** "REMOVE" and **VALVE 2** to **C** "REMOVE" positions.
- Let coolant fill Cooling System until vacuum gauge stops. **NOTE:** Extraction Straw is not used.
- Remove RadNeck assembly to check level of coolant.
- If more coolant is required, follow "EVACUATE AIR" instructions.
- Follow "FILL NEW COOLANT" instructions.

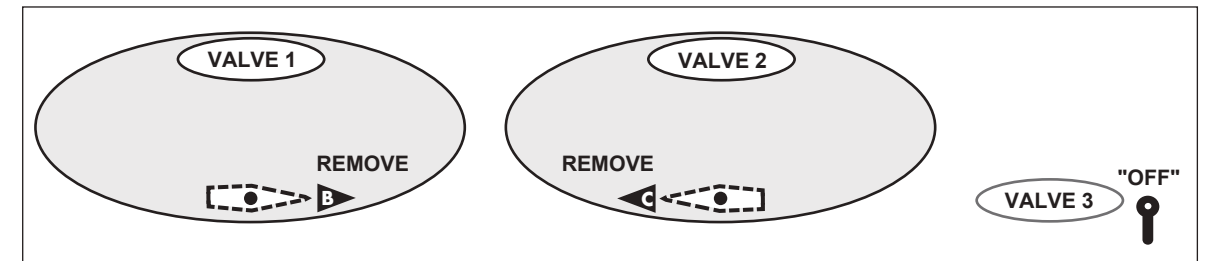

## TO FILL NEW COOLANT INTO COOLING SYSTEM

Vehicle cooling system must be evacuated. See "TO EVACUATE AIR" instructions.

1. Fill clear container with the recommended coolant for the vehicle.  
**NOTE:** Make sure there is more coolant in the container than the system requires.
2. If the removed coolant is to be reused, proceed with "REUSE COOLANT" instructions and pour the reused coolant into the clear container.
3. Set **VALVE 1** to **B** "REMOVE" and **VALVE 3** to "OFF" .
4. Set **VALVE 2** to **E** "FILL". The gauge will start to drop as coolant flows into the cooling system.
5. Radiator is full when the gauge stops. For vehicles with side tanks, stop when proper fluid level is reached.

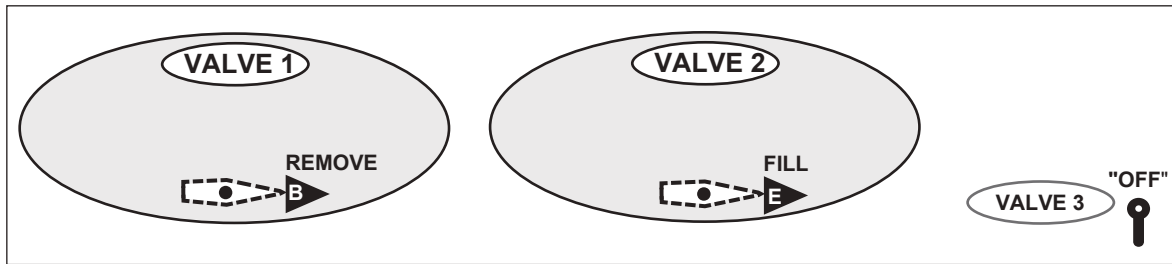

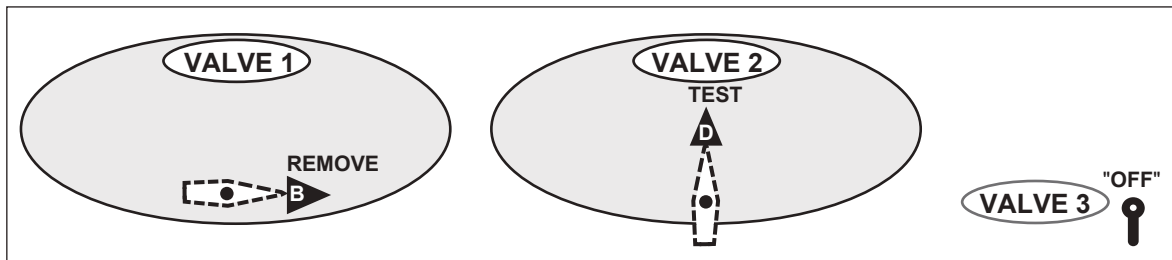

## TO STOP FILLING COOLANT

1. When the vacuum gauge reading stops, set **VALVE 2** to **D** "TEST" position.  
For side tank vehicles, fill coolant to proper level before setting valves.  
**NOTE:** If gauge reading continues to drop and the container is almost empty, add more coolant to the container until the gauge reading stops.
2. Remove RadNeck assembly from cooling system.
3. Top-up cooling system to proper level.
4. Start vehicle to warm up cooling system. Add coolant if necessary before replacing cap for the cooling system.



## REMOVE COOLANT FROM HOT SYSTEMS

Cooling systems run at high temperature and pressures. Pressure must be relieved before removing cooling system cap.

1. Disconnect the Extension Tube Assembly or RadNeck Assembly from the extraction hose via the coupler connection. ( **Figure 4** )
2. Remove overflow coolant hose from the side pressure tank or radiator neck. Determine if the overflow nipple fits a 5/16" or 3/8" size hose. ( **Figure 5** )
3. Select the proper size overflow extraction hose (2 supplied) and attach open end to the overflow nipple with clamp. ( **Figure 6** )
4. Attach the overflow extraction hose to the extraction hose with coupler. ( **Figure 7** )
5. Set **VALVE 1** to **B** "REMOVE" and **VALVE 2** to **C** "REMOVE" and **VALVE 3** to "ON"  (airline is already attached to VACUFILL).
6. Vacuum gauge will start to rise and coolant will flow into hose.
7. After coolant stops flowing, slowly turn cooling system cap (do not remove cap at this time). This will allow more coolant to flow into the VACUFILL.
8. Once coolant has stopped flowing, turn **VALVE 2** to **D** "TEST" then **VALVE 3** to "OFF" .
9. Disconnect the overflow coolant hose from the extraction hose via coupler. This will remove the vacuum from the cooling system and allow easy removal of the cooling system cap. ( **Figure 7** )
10. Disconnect the overflow extraction hose from the overflow nipple and reconnect overflow coolant hose.
11. Now follow the instructions for "Removing Coolant from an Open System".

**WARNING!** Gloves and protective eyewear must be worn. Risk of burns may result from high coolant temperatures and pressures.

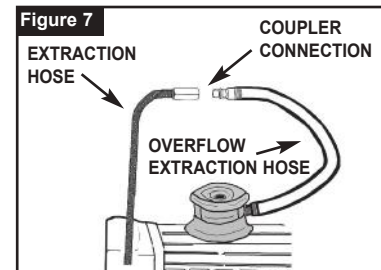
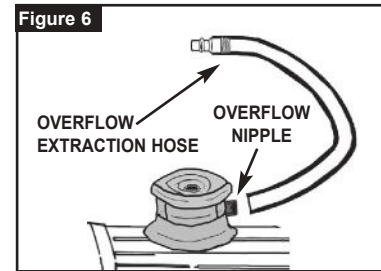
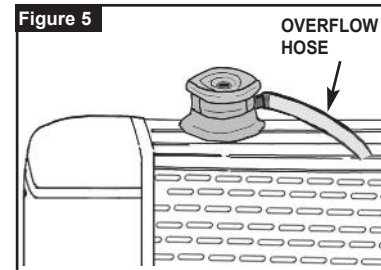
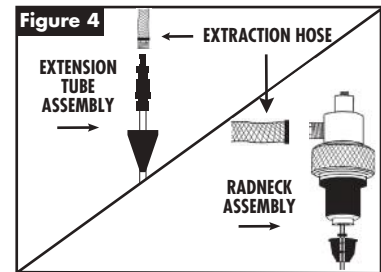



## DRAFT EFFECT PROCEDURE

This procedure is performed once the open system procedure is completed to maximize coolant removal.

1. Disconnect the Extension Tube Assembly or RadNeck Assembly from the extraction hose via the coupler connection. ( **Figure 9** )
2. Remove heater hose at heater core leading to the water pump. ( **Figure 10** )
3. Plug or pinch off the removed hose using appropriate tools (pinch-off pliers or heater core plugs).
4. Temporarily plug heater core using heater core plug (not included).
5. Draw system down to 24-26 inches of vacuum.
6. Remove the temporary plug from the heater core.
7. The rush of air onto the cooling system will sweep coolant from the heater core and engine block into the radiator.
8. For best results, repeat this procedure until no more coolant is extracted.
9. Remove all plugs and pinch-off pliers, reinstall heater hose and draw system down to 24-26 inches of vacuum
10. Set **VALVE 2** to **D "TEST"** to check cooling system for any vacuum leaks.

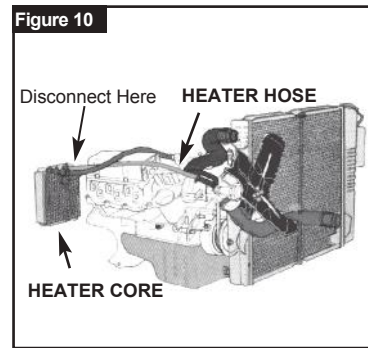
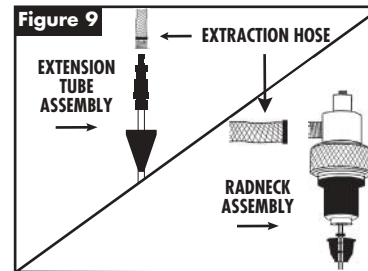

## REMOVE COOLANT FROM OVERFLOW TANK

An Extension Tube Assembly is needed to remove coolant from Overflow tanks. The tube in the Extension tube Assembly should reach the bottom of an Overflow tank. If not, then slide the Cone up the tube until it reaches the bottom.

1. Set **VALVE 1** to **B "REMOVE"** and **VALVE 2** to **C "REMOVE"** and **VALVE 3** to **"ON"** .

There will be a hissing sound from the Coolant Changer system.

2. Repeat Steps 8 to 10 (Pg. 2) to remove coolant.

## TO EVACUATE AIR FROM COOLING SYSTEM

1. Attach and secure RadNeck assembly to cooling system.
2. Clamp off over-flow hoses to get a vacuum in the cooling system.
3. Attach air-line hose to **VALVE 3**.
4. Set **VALVE 1** to **B "REMOVE"** and **VALVE 2** to **C "REMOVE"** and **VALVE 3** to **"ON"** .

If vehicle is warm, the gauge will show a vacuum reading of 15 (Minimum). If the vehicle is cold then a higher reading will show between 15-26.

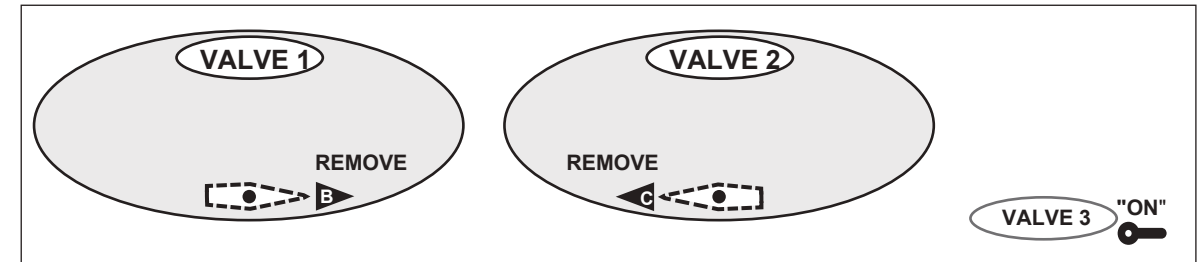

## TO TEST VACUUM

1. The air in the radiator must be evacuated. (See instructions above).
2. After one minute, set **VALVE 2** to **D "TEST"**, set **VALVE 3** to **"OFF"** .
3. Observe gauge for 20 seconds for any drop in vacuum. No drop in vacuum means no leaks. If there is no vacuum loss then proceed with filling the cooling system.

**NOTE:** Fill cooling system with proper coolant as per manufacturer's specifications.

