

FLG4 GRAVITY FEED GUNS



HVLP Solvent-based Value Kit Includes:

- 1.3mm, 1.5mm & 1.8mm fluid tips
- 900cc aluminum cup, air adjusting valve with gauge

HVLP Waterborne Value Kit Includes:

- 1.3mm, 1.5mm & 1.8mm fluid tips
- 20 oz. Acetal cup, air adjusting valve with gauge

HVLP Gun Value Kit Includes:

- 1.8mm & 2.2mm fluid tips
- 900cc aluminum cup

Waterborne compatible when using a plastic or disposable cup system.



Order No.	Model No.	Fluid Tip	Air Cap	Cup	Application
803558	FLG-670	1.3, 1.5, 1.8	HVLP #3	900cc Aluminum	Top coats, light primers
803559	FLG-671	1.3, 1.5, 1.8	HVLP #3	20 oz. Acetal	Waterborne top coats, light primers, primers
803560	FLG-678	1.8, 2.2	HVLP #3	900cc Aluminum	Primers, liquid masking, chip guards, other specialty materials

FinishLine® Gravity Feed Air Caps

#3 air cap (HVLP)	Primers, basecoats, clearcoats, single stage and low VOC Air Cap Order No. 690001 Air Cap Model No. FLG-1-3 13 CFM @ 23 PSI inlet	Air Cap Pattern 10½"
Fluid Tips	1.3mm, 1.5mm, 1.8mm, 2.2mm	



Refer to Service Bulletin: SB-2-775

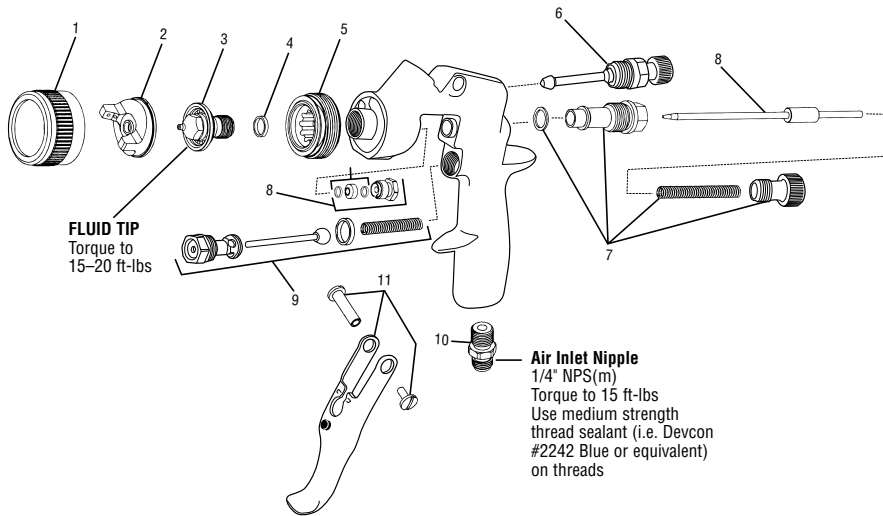

Ref. No.	Order No.	Model No.	Description	Ind. Parts Req.
1	690017	FLG-333	Retaining Ring	1
2	See Air Caps chart, above		Air Cap	1
3	See Chart 1		Fluid Tip & Seal Kit	1
4	690020	FLG-304-K5	Fluid Tip Seal (Kit of 5)	1
5	690021	FLG-305	Baffle	1
6	803528	FLG-465	Spreader Air Adjustment Valve	1
7	803525	FLG4-364-K	Needle Knob, Spring, Bushing & Gasket Kit	1
8	803526	FLG4-366-K	FLG4 Needle, Needle Packing & Nut Kit	1
9	190780	JGS-449-1	Air Valve & Gasket Kit	1
10	190287	P-MB-51	Air Inlet Nipple	1
11	191943	JGS-477-1	Trigger, Trigger Stud & Screw	1
12	192151	KGP-13-K5	Cup Gasket Kit (Kit of 5)	1
13	702576	702576	Metal Gravity Feed Cup	1
	190252	GFC-501	Acetal Gravity Feed Cup	1
14	190944	GFC-404-K2	Disposable Lid Kit (Kit of 2)	1
15	190181	KGP-5-K5	Filter Kit (Kit of 5)	1
	803527	FLG4-488-K	FLG4 Gun Repair Kit (Contains 1 each: Fluid Tip Seal, Needle Packing, Trigger Stud, Trigger Screw, and Gasket for Air Valve & Needle Bushing.)	1
	519210	FLG-463	Air Cap #3 HVLP Test Cap	1

Cup Drawing

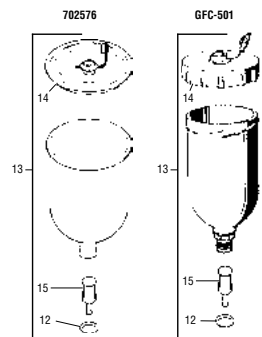
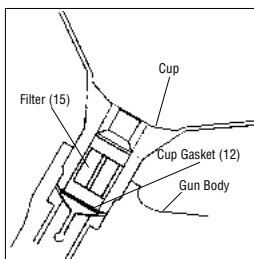

CHART 1

Fluid Tip Order No.	Part No.	Tip Size (mm)	Application
803051	FLG-332-13K	1.3	Stains, lacquers, basecoats, clears
803052	FLG-332-15K	1.5	General purpose, light to medium viscosity materials
803053	FLG-332-18K	1.8	Primers, medium viscosity materials
803054	FLG-332-12K	2.2	Heavy materials

Gravity Feed Cups

Cups to fit DeVilbiss, Binks, FinishLine, and TEKNA Gravity Spray Guns

Order No.	Model No.	Cup Size	Application
190252	GFC-501	20 oz. Acetal	All full size current DeVilbiss, TEKNA, Binks and FinishLine gravity guns
901430	81-381	8 oz. Aluminum	DeVilbiss SRI, SRIW, SRIPro, and Binks Cub gravity guns
900875	54-4458	4 oz. Aluminum	DeVilbiss SRI, SRIW, SRIPro, and Binks Cub gravity guns
192191	SRI-478-K12	4 oz. Nylon	DeVilbiss SRI, SRIW, SRIPro, and Binks Cub gravity guns
702576	702576	900cc Aluminum	All full-size current DeVilbiss, TEKNA, Binks and FinishLine gravity guns
803510	DPC-503-K24	3 oz. Plastic	Fits on all DPC adapters



GFC-501



702576



81-381



SRI-478-K12



DPC-503-K24



54-4458

StartingLine Gravity Feed Cups

Order No.	Cup Size	Application
803610	600cc Aluminum	StartingLine Finish Coat and Primer gravity guns
803609	250cc Aluminum	StartingLine Detail gravity guns
803591	600cc Aluminum	Push-in lids (2)
803590	250cc Aluminum	Push-in lids (2)



803610



803609



803590



803591

E-Z Liners

Most Economical Disposable Paint Cup System Available

- Saves time with easy clean up and less mess
- Saves money by greatly reducing solvent use for clean up

Order No.	Model No.	Description
190966	OMX-70-K48	E-Z Liner Kit (48 liners & bushings)



Gravity Cups PARTS & ASSEMBLY

Refer to Service Bulletins: SB-4-261 (GFC-501), TB-1003 (702576)
Refer to Part Sheets: 77-2739 (81-381) and 77-2719 (54-4458)

702576 TEKNA Gravity Feed Cup/Aluminum

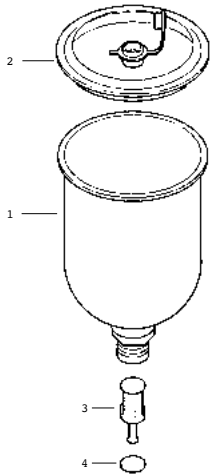

Ref. No.	Replacement Part No.	Description	Ind. Parts Req.
1	702576	Metal Gravity Feed Cup (900cc)	1
2	GFC-404-K2	Disposable Lid Kit (Kit of 2)	1
3	KGP-5-K5	Filter Kit (Kit of 5)	1
4	KGP-13-K5	Cup Gasket (Blue) (Kit of 5)	1

900875 (54-4458) 4 oz. Aluminum Cup

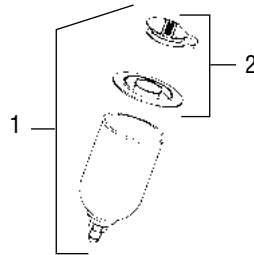

Ref. No.	Order No.	Model No.	Description	Ind. Parts Req.
1	900875	54-4458	Gravity Feed Cup Assembly (4 oz.)	1
2	900902	54-4539	4 oz. Cup Lid Assembly (Kit of 3)	1

190252 (GFC-501) Gravity Feed Cup/Acetal

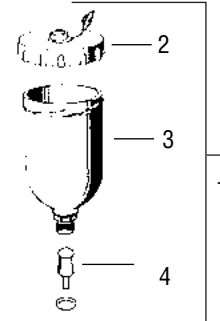

Ref. No.	Order No. Model No.	Description	Ind. Parts Req.
1	190252 GFC-501	Cup Assembly, 20 oz. Acetal	1
2	190225 GFC-402	Cup Lid Assembly	1
3	190181 KGP-5-K5	Filter (Kit of 5)	1
4	192151 KGP-13-K5	Cup Gasket (Blue) (Kit of 5)	1

● For GTI, FLG, M1-G, PRI and GFG Plus (Blue)

901430 (81-381) 8 oz. Aluminum Cup

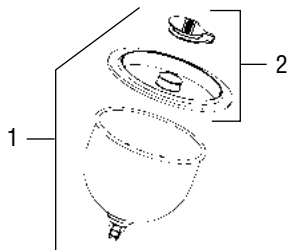

Ref. No.	Order No.	Model No.	Description	Ind. Parts Req.
1	901430	81-381	Gravity Feed Cup Assembly (8 oz.)	1
2	900787	54-4251	Cup Cover Kit (Kit of 3)	1

192191 (SRI-478-K12) 4 oz. Disposable Nylon Cup & Lid Kit

Contains 12 Cups and 12 Lids
(4 ea. Red, Yellow & Green)



803510 (DPC-503-K24) 3 oz. Plastic Cups and Lids Kit of 24

