

Hose and Connections

GENERAL INFORMATION

HOSE CONSTRUCTION

Liner/Tubing - The liner is the workhorse of all hose. Its job is to convey air or material from a supply point to point of use. All other components of the hose help the liner to perform its job. Refer to the Hose Sales Catalog, Form I-5005, (latest revision) for proper liner selection. When hose has no other component parts except the liner, it is usually referred to as tubing, such as H-2339 polyethylene tubing.

Wound Reinforcement - In the make-up of DeVilbiss hose, the use of spiral Rayon reinforcement helps to strengthen the liner and prolong its use. This is necessary since the liner alone cannot withstand too great a pressure.

Cover - The covers used on some hose help to retard the breakdown of the hose (liner and/or braid) due to paint, oil, temperature variations, exposure and constant use. Varying conditions require different type covers. Refer to the Hose Sales Catalog, Form I-5005, for the cover-liner combination best suited for each situation.

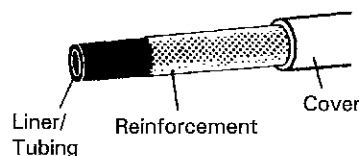

Figure 1

SELECTING THE PROPER AIR HOSE

Hose which is too small (inside diameter) or too long, will starve the spray gun or air tool. Therefore, the hose must be large enough and of proper length to carry a sufficient volume of air to the point of usage with minimum pressure drop. Common sizes of spray gun air hose are 1/4", 5/16" and 3/8" inside diameter. The larger the hose the less restriction there is in the volume and the smaller the drop in the air pressure. The preferable size, therefore, is usually 5/16" or 3/8". The 1/4" size air hose is not recommended with a standard production spray gun and should never be used in such applications in lengths over 12'. Use of 1/4" hose should be restricted to dead end use such as pressure tank supply.

Air pressure drop is the difference between the pressure at the point of supply and the actual pressure at the spray gun. The loss of air pressure is due to frictional resistance within the hose.

Naturally, pressure drop occurs throughout the entire air system from air compressor to spray gun or tool and cannot be eliminated entirely.

For our purpose here, consider that drop which occurs in the air hose between the transformer or regulator, and the spray gun or air tool.

See Chart (Column 3) for pressure drop to be expected from various lengths of 1/4", 5/16", 3/8" and 1/2" inside diameter air hose.

Note the difference in pressure drop when comparing hose sizes. If the smaller, lighter weight hose will deliver the proper amount of air at the right pressure for the work, then it should be used in preference to a larger size, heavier hose.

Any length of hose may be checked for amount of pressure drop in five easy steps as follows:

1. Connect hose to be used to regulated outlet of transformer or regulator.
2. Assemble test gauge (such as HAV-501) to gun or tool end of hose.
3. Connect gun or tool to test gauge.
4. Pull trigger on gun or start tool.
5. Read test gauge. This is the actual air pressure at the point of delivery. Be sure to measure under flowing or working conditions.

Simplified Formula:

$$\frac{\text{Transformer Regulator Reading}}{\text{Test Gauge Reading}} = \text{Amount of Pressure Drop}$$

Working pressure is another factor to consider especially where high pressure equipment is used. Be sure that hose will withstand the pressure to be used.

Recommended air hose sizes for general purpose conventional or HVLP spray guns:

- Up to 25 ft. - Use 5/16" I.D. hose
- 25 to 50 ft. - Use 3/8" I.D. hose
- 50 - 100 ft. - Use 1/2" I.D. hose

SELECTING THE PROPER FLUID HOSE (Standard)

Hose must be large enough to carry a sufficient volume of material to meet the requirements of the job. This permits the operator to work at his own speed and not be slowed by a supply line which is too small.

Pressure drop at ground level is relatively small as compared to the drop at an elevated level for hose of comparable length and size. At elevated levels the pressure should be increased to supply the spray gun with sufficient material.

A general rule to follow in determining pressure drops at elevated levels is that a loss of 1/2 psi will be experienced for every 1 ft. rise in elevation.

Working pressure should also be considered when selecting fluid hose especially where high pressures are required, to ensure that hose will withstand the pressure to be used.

Air flow Through Hose

Hose sizes: 1/4" to 1/2" I.D.

This chart is for approximating and should serve only as a guide in sizing air hose. Pressure drops are directly proportional to hose lengths, i.e. if hose length doubles, pressure drop doubles.

Following is a guide to estimated pressure losses for a 50' length of hose.

Hose I.D.	10 CFM	15 CFM	25 CFM	40 CFM	100 CFM
1/4"	26	50	NR	NR	NR
5/16"	8	18	50	NR	NR
3/8"	4	6	18	50	NR
1/2"	1	2	4	8	50

Air pressure losses are directly proportional to hose length, i.e., for a 100' hose multiply the above by 2, for 150' multiply by 3, for 25' multiply by .1/2. NR = Not Recommended for use at these CFM ratings.

Examples: 50' x 1/2" I.D. hose at 40 CFM has a pressure loss of 8 psi. 200' x 1/2" I.D. will lose 32 psi.

CONNECTION CONSTRUCTION

The purpose of the connection is to provide a lasting leakproof contact between the hose and the equipment and allow attachment to the spray gun or other device.

Of the many different types of connections used, the two most common are the standard (or threaded) and the quick detachable types. In the majority of cases, both employ the compression ring principle of attachment to the hose. In those cases where a compression ring is not used, (example: tubing connections or heater hoses) the connection employs a tapered stem which fits into the tubing and forms a seal when the sleeve is tightened.

The compression ring is normally a split brass ring. In some instances, as with polyethylene tubing, a solid nylon ring is used. Regardless of the type of ring used, both employ the same principle of design and perform the same function. When the sleeve, which is tapered on the inside, is tightened against the bevel of the ring, it compresses the ring around the hose and grips the connection stem tightly, forming a seal on the stem. In most cases the stem is designed with a series of ridges on the outside to increase the gripping and holding power of the connection on the hose.

Some nylon rings have a more pronounced bevel on one side than on the other. It is important when replacing the ring to be sure the new ring is installed in the same position as the one removed.

Another important design feature of connections used with fluid hose is the angular cutout on the inside of the body on the connection (the part where the hose is pushed against when installing). This feature is designed to minimize "liner cold flow", i.e. the tendency for the liner to "back-up" or move towards the end of the stem and actually curl over the open end of the stem causing a restriction of material flow. The angular cutout lessens this condition by providing a space between the end of the hose and the connection body thereby allowing this "free space" to absorb the liner.

SELECTING THE PROPER CONNECTION

The type of application will, in most cases, govern the type of connection most suitable for the situation.

TYPES OF CONNECTIONS

Quick Detachable - (Commonly referred to as Q.D.) - used when frequent removal of hose is necessary. A quick detachable stem is used on the spray gun or air tool.

Standard or Threaded - for use when frequent removal of hose from spray gun or air tool is not necessary.

Straight Connection - for use when hose is not subjected to bending at connection sleeve. Available in standard or quick detachable type.

Bent Connection - for use when hose is subjected to continuous bending or flexing at connection sleeve. Available in standard type only.

Connection with Spring Guard - for use with nylon and polyethylene tubing.

SELECTING THE PROPER CONNECTION

1. Measure hose size, both inside diameter (I.D.) and outside diameter (O.D.).
2. Check equipment for thread size and whether a male or female connection is needed.
3. Select hose size and desired thread size and order corresponding connection listed.

INSTALLATION

1. Cut hose to desired length. End of hose must be cut off square with no nicks or ragged edges. Use a sharp instrument to ensure a clean cut.

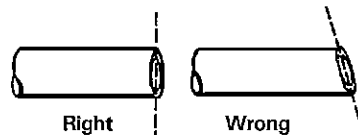

Figure 2

2. Slide spring guard, if connection has one, and sleeve over end of hose.

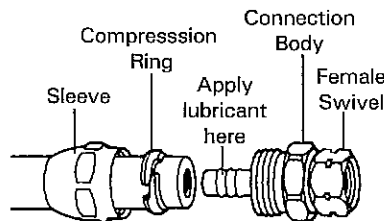

Figure 3

3. Next, slide ring over end of hose. If necessary, pry the ring apart slightly to fit over hose.
4. Place connection body in vise and push hose onto stem as far as it will go. As an aid in putting the connection onto hose, either the male end of the connection or the end of the hose can be dipped in glycerin or SSL-10 gun lube which will act as a lubricant and allow the two to slip together more easily.
5. Slide ring up to connection body.
6. Slide sleeve forward, over ring and thread onto body. Tighten with wrench.

ERGOFLEX HOSE CONNECTION INSTALLATION INSTRUCTIONS

1. Slide hose cap over connection (open side facing away from swivel).
2. Apply a liberal amount of SSL-10 gun lube evenly to the tapered barb.
3. Press connection into hose by hand as far as possible over the threads.

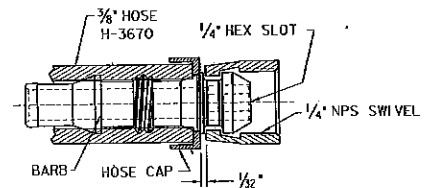

Figure 4

4. Using a 1/4" T-Handle Allen wrench and while holding hose in hand as shown in Figure 5, install male stem by pressing firmly, turning clockwise with the wrench. Continue turning until hose cap is approximately 1/32" from swivel.

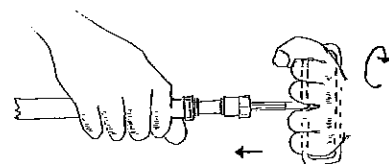

Figure 5

PARTS REPLACEMENT

To Remove Connections From Hose:

1. Place connection body in vise and with a wrench, loosen sleeve and slide it back on hose.
2. Gently pry ring loose with a screw driver and slide it back on hose. Do not distort ring any more than is necessary. This will insure a good seal the next time the connection is used.

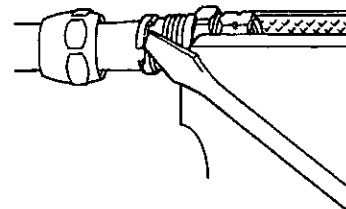

Figure 6

3. Remove hose from connection stem. Clean stem and body.

If the old ring is badly distorted, it is suggested that a new ring be used.

PREVENTIVE MAINTENANCE

Cleaning

To Clean Fluid Hose:

1. Turn off air supply to pressure tank.
2. Relieve air pressure in tank, loosen and set tank lid aside as shown in Figure 7.

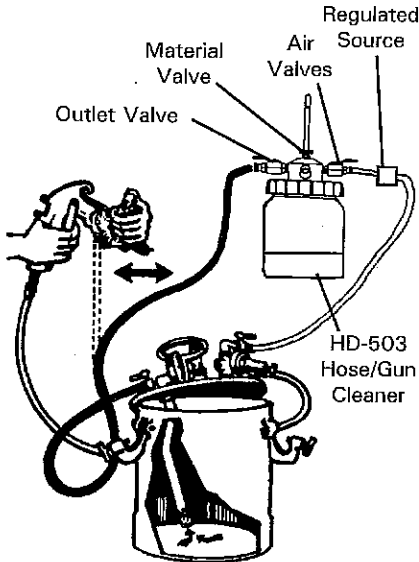

Figure 7

3. Loosen retaining ring on spray gun, hold rag over cap and trigger gun. Air will flow in reverse path forcing material back into container. Empty and clean tank.

4. If at all possible, use a HD-503, 2 quart hose cleaner, and clean hose as follows. See Figure 7.

- a. Remove hose from gun and tank, attach it to hose cleaner.
- b. Fill hose cleaner with solvent used with the material.
- c. Hold loose end of hose over waste container and open air valves.
- d. Open material valve approximately 2 turns counterclockwise. Allow material valve to remain open until clean solvent appears.
- e. Close material valve leaving air valves open until hose liner dry.
- f. Close air valves, remove hose.

5. If a pressure tank must be used to clean, proceed as follows using a clean tank:

- a. Pour some solvent normally used with the material into tank or insert container.
- b. Reset tank lid, tighten clamps and apply pressure in tank.
- c. Spray until clean solvent appears.
- d. Repeat Steps 1, 2 and 3.
- e. Remove hose from gun and tank.

6. Wipe off tank cover with solvent soaked cloth.

Note

Local environmental legislation may prohibit discharging solvent into the atmosphere. If this is the case, a spray gun cleaning cabinet must be used.

Hints for prolonging the life and service of your hose:

Do Not hang hose over a nail or peg. Loop hose over hanger at least a foot in diameter.

Do Not expose hose to extreme heat or cold.

Do Not drag hose over rough or sharp object or surfaces which may tear cover. If hoses must be moved from location to location outside the booth, it is best to coil them and pick them up for moving.

Periodically inspect hose for abrasive tears or apparent damage. For safety, it is best to replace any questionable fluid or air hose.

Do Not allow trucks or heavy equipment to be driven or dragged over hose.

Do Not let end of hose soak in a solvent incompatible with material of which hose is constructed. This may result in connection loosening and cover deteriorating.

Do Not allow solvent to remain in or on hose for prolonged periods of time.





TROUBLESHOOTING

Problem	Cause	Correction
Cover separates from braid.	Re-used compression rings sometimes do not grip hose properly when hose and connections are assembled. This may permit air or fluid to work its way into the hose wall causing bubbles and eventual hose failure.	If available, always use a new compression ring when putting a connection on a length of hose.
Particles which seem to be flaked liner or even a tube formed inside a thiokol liner.	Paint left in hose after cleaning combined with the plasticizer in thiokol that is extracted by the solvent during the flushing action.	Clean thoroughly with hose cleaner using solvent, then dry with air each time hose is used.
Excessive pressure drop.	Connection fitting loose or worn permitting air to leak. Hose old or partly filled with accumulated material. Improper size hose. Supply pipe corroded or rusty. Restriction from cold flow of thiokol liner.	Replace connections. Replace hose. Replace hose (See Figs. 2, 3, & 6). Clean or replace pipe. Cut back and reset connection.

TROUBLESHOOTING (Continued)

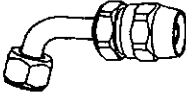

<p>Weak spots develop, sometimes causing hose to burst.</p>	<p>Air or material pressure too great.</p> <p>Bending hose at connection.</p> <p>Cuts from being dragged across sharp edges.</p> <p>Hanging hose over a nail or hook when in storage will cause the cover to stretch on the top side weakening the hose in this spot.</p> <p>Hose sleeve not drawn up tight enough. This will permit air or material to leak past the connection body stem around to the end of the hose. From there the air or material will follow the braid in the hose, causing the cover to burst.</p>	<p>See Hose Sales Catalog for hose recommendations.</p> <p>Use a bent hose connection or bent adapter.</p> <p>Remove the sharp edges if possible or tape hose; renew tape when worn.</p> <p>Use a large radius hanger at least a foot in diameter.</p> <p>Remove connection. Cut hose back beyond injury. Replace connection drawing sleeve up tight on connection body.</p>
<p>Air leaking around connection.</p>	<p>Worn threads or damaged seats.</p> <p>Connection installed improperly.</p>	<p>Replace with new connection.</p> <p>Re-install. See "Installation".</p>
<p>Will not fit properly.</p>	<p>Wrong thread size and type.</p> <p>Material residue or dirt left on/or in connection.</p>	<p>Check thread size and type.</p> <p>Clean.</p>

Reusable Hose Connections - Standard for Air and Fluid Hose

Hose Size & Type			Thread Size	Straight Connection	Bent Connection	Straight Connection	Common Parts to Each Connection	
Hose I.D.	Size O.D.	Fits DeVilbiss Hose No.		Female Thread	Female Thread	Male Thread	Sleeve Number	Ring Number
				Complete Connection Number	Complete Connection Number	Complete Connection Number		
								
1/4"	1/2"	H-1975-1 H-1900 H-1957	1/4" NPS 3/8" NPS 3/8" NPS 1/4" NPS 3/8" NPS	P-HC-4523 P-HC-4543 P-HC-4543 P-HC-4702+ P-HC-4703+	P-HC-4503		HC-267-K3 HC-267-K3 HC-267-K3 HC-267-K3 HC-267-K3	HC-20-K10 HC-20-K10 HC-20-K10 HC-299 HC-299
5/16"	5/8"	H-1641-1 H-1901 H-1976-1 H-1921	1/4" NPS 3/8" NPS 1/4" NPT	P-HC-4527 P-HC-4547	P-HC-4507	P-HC-4599	HC-268 HC-268 HC-268	HC-12-K10 HC-12-K10 HC-12-K10
3/8"	11/16"	H-1973-1 H-1958 H-1995	1/4" NPS 3/8" NPS 3/8" NPS	P-HC-4528 P-HC-4548 P-HC-4561+			HC-269 HC-269 HC-269	HC-23-K10 HC-23-K10 HC-23-K10
1/2"	7/8"	H-1974-1 H-1961	3/8" NPS	P-HC-4551			HC-273-K3	HC-33

+ Stainless Steel insert.

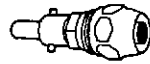





Hose Connections - Quick Detachable for Air Bayonet Lock Type

Hose Size & Type			Hose Connection Valve Complete Connection Number	Maximum Complete Working Pressure	Identification Material of Construction	Hose Connector Stem Complete Connection	Maximum Working Pressure	Material Of Construction	Common Parts	
Hose I.D.	Size O.D.	Fits DeVilbiss Hose No.							Sleeve Only	Ring Only
										
1/4"	1/2"	H-1900 H-1957	HC-418	250	Aluminum	NA	NA	NA	HC-267-K3	HC-20-K10
5/16"	5/8"	H-1901 H-1921	HC-419	250	Aluminum	HC-461	250	Brass, Plated	HC-268	HC-12-K10



Swivel Type Thread Attachment

						
Thread Size And Type	Threaded Connection Valve	Maximum Working Pressure	Material of Construction	Threaded Connector Stem	Maximum Working Pressure	Material of Construction
1/4" NPT(M) 1/4" NPT(F) 1/4" NPS(F)	P-H-4091 P-H-4090 NA	250 250 NA	Brass, Plated Brass, Plated NA	P-H-4069 P-H-4070 P-H-4072	250 250 250	Steel, Plated Steel, Plated Brass, Plated

**Replacement Parts Kit For Bayonet Lock Type Connections Shown Above.
Assemble parts in order shown below.**

						All parts shown included in Repair Kit KK-4283
*"U" Cup Seal	*Spacer for Hose Connection Valve	*Spacer for Threaded Connection Valve	*Washer	*Valve	*Spring	







Quick Detachable Hose Connections for Air - Ring and Ball Lock Type

Hose Size & Type			Hose Connection Valve Number	Ring Number	Stem Number Pressure	Maximum Working	Construction Material
Hose I.D.	Size O.D.	Fits DeVilbiss Hose No.					
							
1/4"	1/2"	H-1900 H-1957	HC-4508	HC-20-K10	HC-267-K3	250	Brass Plated
5/16"	5/8"	H-1901 H-1921	HC-4511	HC-12-K10	HC-268	250	Brass Plated
3/8"	1 1/16"	H-1958	HC-4512	HC-23-K10	HC-269	250	Brass Plated





Threaded Quick Detachable Hose Connections for Air

Thread Size & Type	Threaded Connection Valve Number	Maximum Working Pressure	Construction Material	Threaded Connector Stem Number	Maximum Working Pressure	Material Construction
1/4"NPT(M)	P-HC-4100	250	Aluminum	P-HC-201	250	Steel Plated
1/4"NPT(F)	P-HC-4120	250	Aluminum	P-HC-196	250	Steel Plated
3/8"NPT(M)	P-HC-4101	250	Aluminum	P-HC-235	250	Steel Plated
1/4"NPS(F)				P-HC-4416	250	Brass Plated



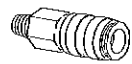

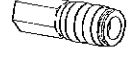

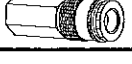
Replacement Parts Kit For Ring & Ball Lock Type Shown Above. Assemble parts in order shown below.

 * Steel Ball (4) Required	 *Ball Cage	 *Spring	 *Seat Holder	 *Valve Seat	 *Valve	 * Spring	*All parts shown included in Repair Kit KK-4284
---	---	--	---	--	---	---	---

High Flow Air Quick Detachable Connectors and Stems:

Thread Size	Q.D. Model No. Number	Stem Model No. Number	Maximum Working Pressure	Material Construction
1/4" NPT(M)	HC-4699 		230	Plated Aluminum - Solvent Resistant
1/4" NPT(M)		HC-1166 	230	Plated Steel
1/4" NPT(F)	HC-4700 		230	Plated Aluminum - Solvent Resistant
1/4" NPS(F)		HC-4419 	230	Plated Steel
1/4" NPT(M)	HC-4719 		230	Brass, Plated Nickol
1/4" NPT(F)	HC-4720 		230	Brass, Plated Nickol

Quick Detachable Fluid Hose Connections:

Thread Size	Connection Number	Maximum Working Pressure	Bayonet Lock Body	Seat Retainer	Stem Seat	Ball Seat Insert	Ball	Spring	Repair Kit	Material Construction
									KK-5061 NEW KIT	
3/8" NPS(M)	P-HC-4808	500	HC-370						KK-5023	Aluminum
3/8" NPS(M)	HC-513	500	...						KK-5023	Stainless Steel
3/8" NPS(M)	QDL-4808	500	QDL-1						KK-5023	Delrin, Stainless Steel

WORLDWIDE SALES AND SERVICE LISTING - www.devilbiss.com

DeVILBISS INDUSTRIAL SPRAY EQUIPMENT - DeVilbiss has authorized distributors throughout the world. **FOR TECHNICAL ASSISTANCE, CALL TOLL FREE 1-800-338-4448 (U.S.A. ONLY).**

DeVILBISS AUTOMOTIVE REFINISHING - DeVilbiss has authorized distributors throughout the world. For equipment, parts and service, check the Yellow Pages under "Automobile Body Shop Equipment and Supplies". **FOR TECHNICAL ASSISTANCE, CALL TOLL FREE 1-800-445-3988 (U.S.A. ONLY).**

