



Levelwind™ Series Retractable Air & Water Hose Reels Parts & Technical Service Guide

Model L8305	Model L8335FZ
Model L8305FZ	Model L8340FZ
Model L8306-EU	Model L8344
Model L8306FZ	Model L8345
Model L8310	Model L8346
Model L8310-EU	Model L8349
Model L8335	Model L8350
Model L8335-EU	



Mounting Options:

CAUTION: Maximum installation height is 15 ft. (4.5 meters) above ground. Maximum weight of hose end tools is 4 lb. (2 kg). Maximum working pressure is 350 PSI (24 bar). (140 PSI (9.65 bar) for Models L8346, L8349 & L8350). 300 PSI (20.68 bar) for Model L8335. Do not stand or step on top of reel!

Mounting to wall

Positioned up to 5 ft. (1.5 m) high. Use standard replacement part L8300-W Wall /Overhead bracket

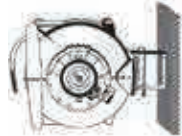

High Wall Mounting

Mount reel between 10 ft. and 15 ft. (3-4.5 m) high on wall. Use optional Bench / High Wall mounting bracket Model L8300-B

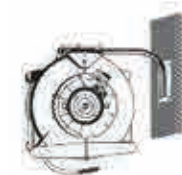

Mounting overhead

Up to 15 ft. (4.5 m) from floor. Use standard replacement part L8300-W Wall / Overhead bracket.



Mounting to a bench

Use optional Bench / High Wall mounting bracket model L8300-B



Installation:

LEVELWIND retractable hose reels are designed for minimum assembly.

- 1) Place bracket on a flat mounting surface. With a pencil trace bracket back holes onto surface. Use a leveling device to ensure that the bracket will be level once fastened. Fasten brackets to surface with screws (screws are not included).
- 2) Remove bracket rod (A) from bracket (B) (SEE FIGURE 1)
- 3) Place reel into bracket making sure the reel hole is aligned with bracket end holes.
- 4) Insert bracket rod through the aligned holes of reel and bracket. Insert hitch-pin clip through end of bracket rod.
- 5) Connect female end of lead-in hose to inlet connection on reel. Connect male end to air or water source (SEE FIGURE 2).

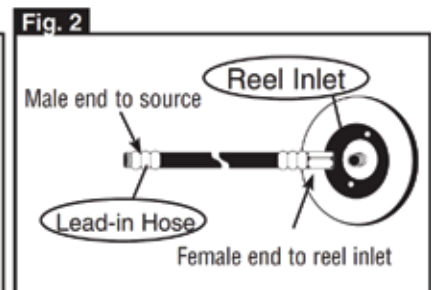
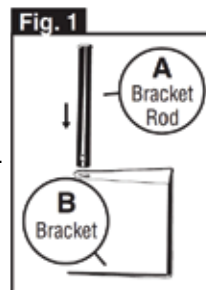

Operating Instructions:

LEVELWIND retractable hose reels can operate in FREERUN or can be latched every 3 ft. (91 cm) by switching to the LATCHING ZONE. Simply turn the mode switch to desired position! (SEE FIGURE 3)

THE "LATCHING ZONE": LEVELWIND reels have a single latching zone. The reel can be latched for every drum revolution approx. 3 ft. (91 cm) of hose. There are audible clicking sounds as the spring loaded latch passes over the latching zone. The latching zone flips the latch so that the latch goes into or by-passes the latching position. Pulling hose straight out off the reel "flips the latch" so it can go into the latching position. Retracting the hose into the reel keeps the latch "flipped" so that the latch by-passes the latching position.

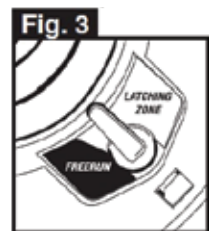

LATCHING - Pull out the desired length of hose. As you are pulling out hose from the reel, listen for a "click". STOP! Don't pull any further! If you keep pulling out hose (more than 14 in. (36 cm)) after hearing the "click", you will have pulled past the latching zone. Now, allow the hose to go back into the reel (less than 14 in. (36 cm)) and the latch will drop into the latching position. The reel is now latched!

RETRACTING - Assuming the latch is engaged in the latching position, pull out hose until you hear a "click" (approx. 14 in. (36 cm)). STOP! Don't pull any further! If you pull out more than 3 ft. (91 cm) of hose after hearing the "click", you will have gone a full drum revolution and back into the latching zone where the reel will once again be latched. Now, allow the hose to retract back into the reel.

The hose reel will continue retracting hose until it is fully retracted. If you decide to re-latch the reel while you are still retracting hose, simply listen for a click. STOP! Slowly pull out hose until you hear a second click. STOP! Don't pull any further. Now, slowly allow the hose back into the reel (less than 14 in. (36 cm)) and the latch will drop into the latching

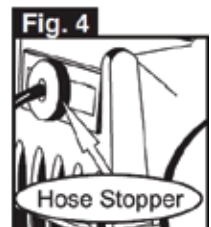

FREERUN MODE: The hose does not latch in this mode. Hose will automatically retract back into reel. The hose stopper position may be adjusted to desired length for application (SEE FIGURE 4) **CAUTION!** Do not release the end of the hose when rewinding as personal injury or damage could result!

The color CHARTREUSE as applied to the body of the air hose is a registered trademark owned by Weems Industries, Inc.
The color CHARTREUSE as applied to the body of the water hose is a trademark owned by Weems Industries, Inc.

SEVEN POSITION LOCKING BRACE

LEVELWIND retractable hose reels can swing freely on bracket or can be locked in one of seven positions, allowing for specific mounting requirements.

Standard bracket

- 1) Remove bracket rod from reel. (SEE FIGURE 5A)
- 2) Place seven position locking brace over bracket so that bracket rod holes are aligned. Replace bracket rod so that brace, reel & bracket are attached. Insert hitch-pin clip through end of bracket rod.(SEE FIGURE 5B)
- 3) Rotate bracket so that it is at desired angle & lock into place with fastener. (SEE FIGURE 5B)

Fig. 5a

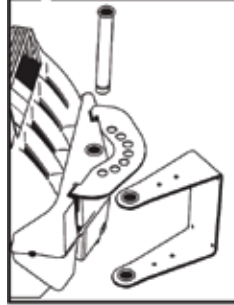

Fig. 5b

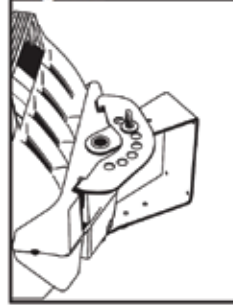
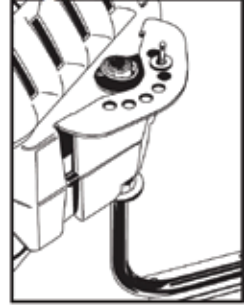

Fig. 6



Optional Bench/High Wall Mounting Bracket (see figure 6)

Maintenance Procedures

TENSION ADJUSTMENT:

This reel is preloaded with spring tension that is set at the factory. If the reel becomes completely un-tensioned, please identify your hose reel model number referenced in the Factory Preset Tensioning Table to find out how many turns are needed for proper tensioning. If a heavy air tool is attached to the end of the hose, you may need to add tension to overcome the weight of this tool. DO NOT EXCEED one full turn past the number of turns listed in the Factory Preset Tensioning Chart below.

TOOLS REQUIRED:

Phillips Screw Driver, 3/4 in. Socket Wrench

- 1) Lay reel on its side. (SEE FIGURE 7)
- 2) Place wrench on hub fitting plate nut. HOLD WRENCH FIRMLY.
- 3) Unscrew hub. DO NOT REMOVE SIDEPLATE.
- 4) Turn wrench either 1/2 turn or no more than one full turn. Turn clock wise to increase tension. Turn counterclockwise to decrease tension.
- 5) Replace hub plate screws and tighten. Return reel to mounting bracket.

Fig.7

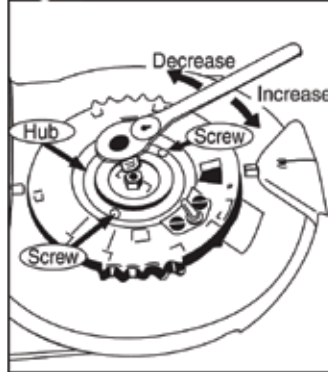

Factory Preset Tensioning Table

Levelwind™ Series Model #	# of Tension Turns
L8305 / L8305FZ	3
L8306 / L8306FZ / L8306-EU L8340FZ	5
L8310	4
L8335 / L8335FZ / L8335-EU	4
L8344 / L8345 / L8346 / L8349	4
L8350	11

HOSE REPLACEMENT:

To ensure proper performance, please consult the Hose Replacement Kit table for the appropriate part number to order. Call 1(800) 645-8258 to order kit.

Replacement Hose Kits

- 1) Pull entire length of hose out of reel. (SEE FIGURE 8)
- 2) While entire length of hose is out of the reel, place long screw driver (3/8 in. in diameter (9 mm)) all the way through the hole located at the back portion of reel. This eliminates any chance for the reel to retract while replacing hose.

Fig. 8

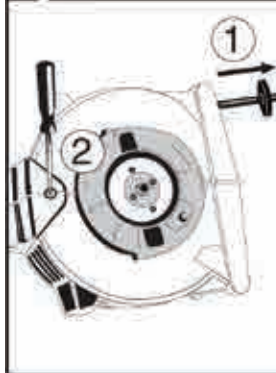

Replacement Hose Kits

Model #	Description
RP005005	Replacement Hose Assembly for L8305
RP005005-FZ	Replacement Hose Assembly for L8305FZ
RP005006	Replacement Hose Assembly for L8306
RP005006-EU	Replacement Hose Assembly for L8306-EU
RP005006-FZ	Replacement Hose Assembly for L8306FZ
RP005008	Replacement Hose Assembly for L8310
RP0050058-EU	Replacement Hose Assembly for L8310-EU
RP005035	Replacement Hose Assembly for L8335
RP005035-EU	Replacement Hose Assembly for L8335-EU
RP005023	Replacement Hose Assembly for L8344
RP005069	Replacement Hose Assembly for L8345
RP005049	Replacement Hose Assembly for L8349, L8346
RP005069	Replacement Hose Assembly for L8350
RP005040-FZ	Replacement Hose Assembly for L8340FZ

Sideplate removal

- 3) Locate inlet sideplate. Remove four fasteners (SEE FIGURE 9). While placing fingers on grooves located on the top and bottom of sideplate, depress locking tabs at the same time with thumbs (SEE FIGURE 10). Rotate side plate either way until sideplate unlocks. Remove sideplate.
- 4) Remove wear plate (SEE FIGURE 11). Unscrew two fasteners on wear ring and remove wear ring (SEE FIGURE 12).

Fig. 9

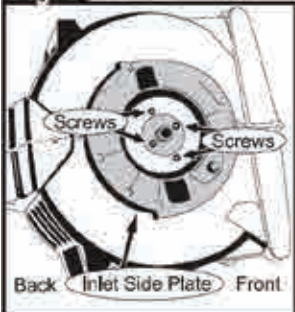

Fig. 10

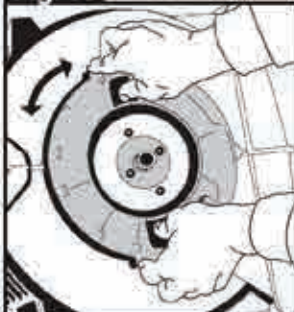

Fig. 11

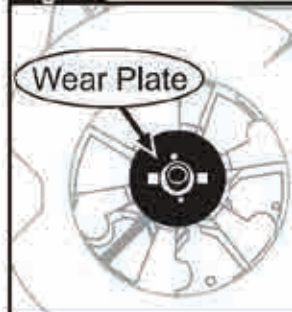

Fig. 12



- 5) Pull swivel assembly firmly from hose spool(SEE FIG. 13 and 14).
- 6) Unscrew Hose Clamp and pull hose off hose barb on swivel. (SEE FIGURE 15)
- 7) Pull remaining length of hose out reel opening located at the reel front.
- 8) Take replacement hose through opening located at the front of reel. Thread hose through hose leveling mechanism. (SEE FIGURE 16)
- 9) Insert hose through the center of the hose spool. Four openings are referenced with the following hose I.D. dimensions located at the center of hose spool: 3/8 in., 1/2 in., 5/8 in. & 3/4 in.. Locate the hose I.D. and pull through that opening. (SEE FIGURE 17) Pull enough hose to allow the hose to connect to hose barb on swivel.
- 10) Replace hose onto hose barb, tighten hose clamp onto hose & place swivel into hose spool housing.
- 11) Replace wear ring and fasten with wear ring screws. Replace wear plate so that the swivel drive tabs insert into wear plate tab receivers. (SEE FIGURE 18)
- 12) Replace sideplate so that the plate snaps flush to side of reel. Turn sideplate until locking tabs connect to sideplate.
- 13) Turn swivel so that fastener holes of swivel and sideplate align. Replace the four sideplate fasteners and tighten.
- 14) Remove screw driver.
- 15) Retract hose back into reel

Swivel Kits

Levelwind Series Model #	Replacement Swivel Body Part #	Replacement Hose Stopper Part #
L8305 - All Models/ L8306 - All Models/ L8310 - All Models	RP005007-38	RP005026
L8335 - All Models/ L8345 / L8350 / L8340FZ	RP005007-12	RP005027
L8344 / L8346 / L8349	RP005007-58	RP005028

- 1) Repeat steps 1- 6 in the HOSE REPLACEMENT procedure.
- 2) Place hose onto hose barb of new swivel body. Tighten hose clamp onto hose & place swivel into hose spool housing.
- 3) Replace wear ring and fasten with wear ring screws. Replace wear plate so that the swivel drive tabs insert into wear plate tab receivers. (SEE FIGURE 18)
- 4) Replace sideplate so that the plate snaps flush to side of reel. Turn sideplate until locking tabs connect to sideplate.
- 5) Turn swivel so that fastener holes of swivel and sideplate align. Replace the four sideplate fasteners and tighten.
- 6) Remove screw driver.
- 7) Retract hose back into reel.

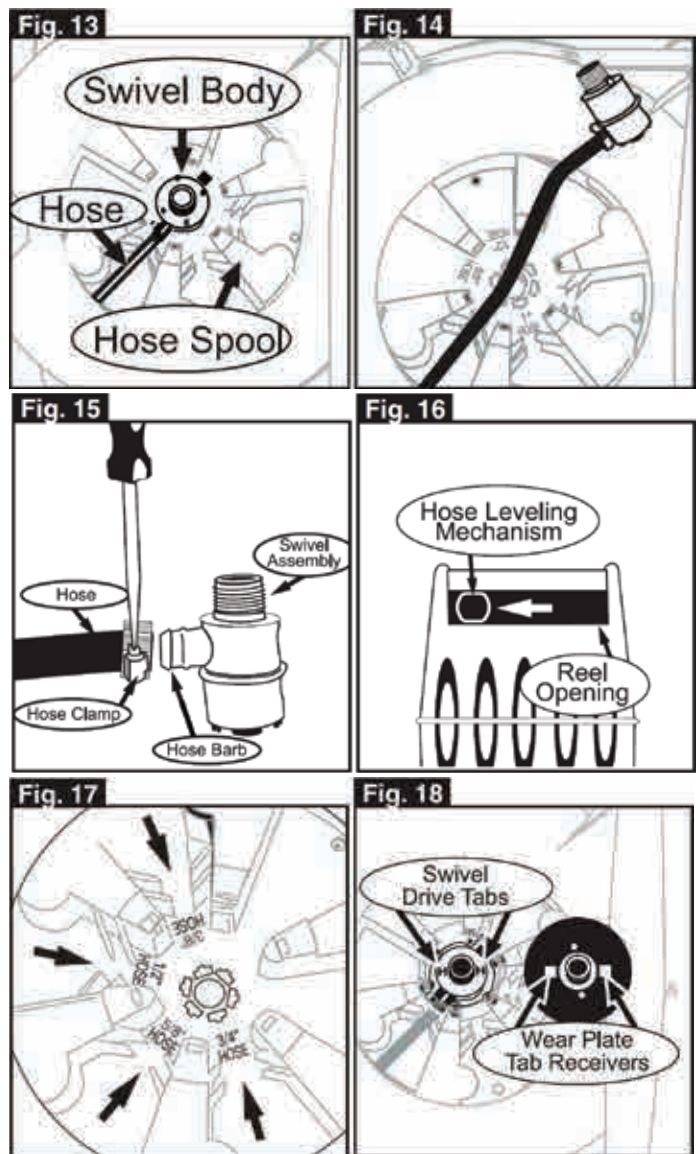

TECHNICAL ASSISTANCE:
 Call 800-645-8258 or email service@legacymfg.com if you have any questions regarding the installation or operation of this reel.

Levelwind™ Troubleshooting Guide

Troubleshooting Questions	Suggested Tips
1. Hose will not retract back into the unit.	1a. Ensure the Latch Spring & Pawl isn't engaged 1b. Follow the Tension Adjustment Procedure (See pg 2) 1c. Replace Internal Drum Assembly
2. Hose will not fully retract back into the unit.	2a. Follow the Tension Adjustment Procedure (See pg 2) 2b. Is the replacement hose too heavy? (Rubber?) 2c. If hose bunches, adjust the Layering Mechanism Timing
3. Hose will not lock in 3' intervals.	3a. Are you releasing the hose too quickly? 3b. Is the Latch Spring & Pawl engaged? 3c. Replace the Latch Spring & Pawl Mechanism
4. Internal leak.	4a. Replace the hose if it is damaged. 4b. Replace the Swivel Body (a-rings are not available separately)

Optional Bench & High Wall Mounting Bracket Model L8300-B

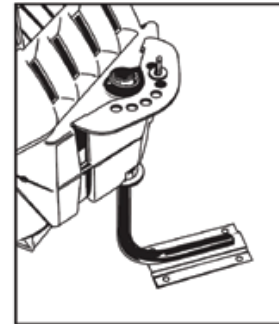
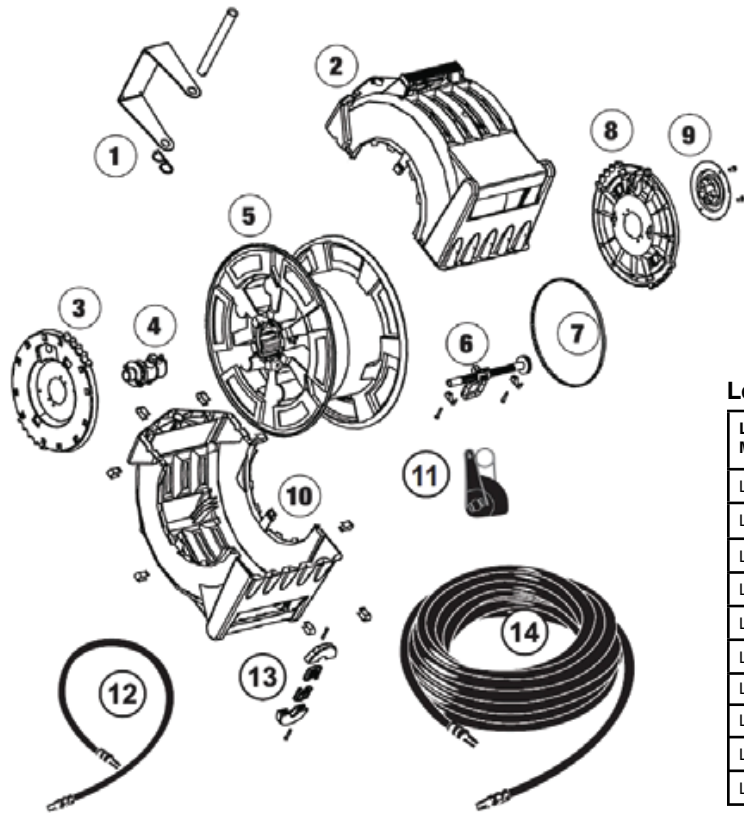

Levelwind™ Series Replacement Lead-In Hoses

Levelwind- Series Model #	Replacement Lead Hose Part #	Replacement Lead Hose Material, Size, & Type
L8305 / L8306 / L8310	L8305LI	PVC 3/8" x 3' Air Hose - Lead In
L8305 / L8306 / L8310	L8305LI-10	PVC 3/8" x 10' Air Hose - Lead In
L8305FZ / L8306FZ	L8305FZLI	Flexzilla® 3/8" x 5' Air Hose - Lead In
L8335	L8335LI	PVC 1/2" x 3' Air/Water Hose - Lead In
L8335	L8335LI-10	PVC 1/2" x 10' Air/Water Hose - Lead In
L8335FZ	L8335FZLI	Flexzilla® 1/2" x 5' Air/Water Hose - Lead In
L8340FZ	L8340FZLI	Flexzilla® 1/2" x 10' Water Hose - Lead In
L8344 / L8346 / L8349	L8349LI	PVC 5/8" x 5' Cold Water Hose - Lead In
L8344 / L8346 / L8349	L8349LI-10	PVC 5/8" x 10' Cold Water Hose - Lead In
L8345 / L8350	L8345LI-10	PVC 1/2" x 10' Potable Water Hose - Lead In

Levelwind™ Series Replacement Parts

Ref.#	Replacement Part#	Description	Needs to be replaced If...	Corresponding Levelwind™ Series Model #
1a	L8300-W	Wall / Overhead Mounting Bracket	New mounting hardware is needed	All Levelwind™ Models
1b	L8300-B	Bench / High Wall Mounting Bracket	An alternative mount is needed	All Levelwind™ Models
2	RP005000BK	Top Outer Housing Half w/ Trim Ring & Housing Clips - Black	The upper housing is damaged	All Levelwind™ Models
3	RP005002BK	Swivel Body Side Plate - Black	The side plate is damaged	All Levelwind™ Models
4	RP005007-xx	Swivel Body - Based on hose inner diameter	Internal leaking	See Rpmct Swivel & Hose Stop Chart
5a	RP005015	Internal Drum Assembly / Retraction Spring- 50' hose reels	The hose does not retract the hose at all	50' Levelwind™ Models
5b	RP005016	Internal Drum Assembly / Retraction Spring- 60', 70', 75', 100' hose reels	The hose does not retract the hose at all	60', 75', 100' Levelwind™ Models
6a	RP005010-14	Layering Device Assembly	The layering mechanism doesn't operate	L8335 - All Models / L8344 / L8346 / L8347 / L8349
6b	RP005010-20	Layering Device Assembly	The layering mechanism doesn't operate	L8305 - All Models / L8306 - All Models / L8310 All - Models / L8345 / L8350
6c	RP005010-18	Layering Device Assembly	The layering mechanism doesn't operate	L8340FZ
7a	RP005012-137	Layering Device Drive Belt	The layering mechanism doesn't operate	L8335- All Models / L8344 / L8346 / L8347 / L8349
7b	RP005012-140	Layering Device Drive Belt	The layering mechanism doesn't operate	L8305 -All Models / L8306 -All Models / L8310 - All Models L8345 L8350
7c	RP005012-138	Layering Device Drive Belt	The layering mechanism doesn't operate	L8340FZ
8a	RP005004BK	Latch Switch Side Plate w/ Latch Spring & Pawl Mechanism- Black	The hose does not lock the desired length	All Levelwind™ Models
8b	RP005004GRNT	Latch Switch Side Plate w/ Latch Spring & Pawl Mechanism- Granite	The hose does not lock the desired length	All Levelwind™ Models
9	RP005003	Tension Cover	The tension cover is cracked or damaged	All Levelwind™ Models
10	RP005001BK	Bottom Outer Housing Half w/ Housing Clips - Black	The bottom housing is damaged	All Levelwind™ Models
11	RP005018	Latch Spring & Pawl Mechanism	The hose does not lock the desired length	All Levelwind™ Models
12	Lead In Hoses	Lead In or Supply Hose	The hose is damaged or leaks	See Replacement Lead Hose Chart
13	Hose Stoppers	Hose Stop	The hose stopper is not stopping the hose	See Replacement Swivel & Hose Stop Chart
14	Hose Assembly	Hose Assembly w/ Hose Stopper	The hose is damaged or leaks	See Replacement Hose Assembly Chart
	RP005036	1/2" FNPT x 3/4"-11 1/2 Male GHT Brass Adaptor	A replacement water hose adaptor is needed	L8335, L8344, L8345, L8346

2 YEAR LIMITED WARRANTY -

LEGACY MANUFACTURING COMPANY ("LEGACY") warrants this product to the original purchaser will be free from defects in material and workmanship for 2 years from date of purchase, under normal use. This LIMITED WARRANTY does not cover products that are improperly used, abused, altered or repaired. To obtain a replacement, this product must be shipped to LEGACY Service Center, transportation charges prepaid, with proof of date of purchase and the original retail label must accompany the product. Include your name and address. Should you have any questions, email service@legacymfg.com.