

"CVA 3" EZ ISOCOLOR

VISUAL HEADLAMP ALIGNMENT SYSTEM

With:

*Visual Assist
Meter*

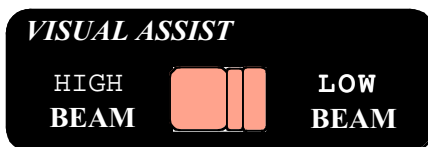

**ASSEMBLY
OPERATION
CALIBRATION**



524 S. E. Transport Drive
Lee's Summit, MO 64081

888-884-8182
816-525-9263 FAX: 816-525-9283
www.symtechcorp.net

INDEX

1. GENERAL *Pg. 3*

- 1.1 *CVA 3 EZ ISOColor* INTRODUCTION
- 1.2 SYSTEM COMPONENTS
- 1.3 LASER WARNING
- 1.4 VISUAL ASSIST METER & SWITCH
- 1.5 *ISOColor* LAMP PATTERN DEFINITION

2. ASSEMBLY *Pg. 4*

- 2.1 BASE / WHEEL ATTACHMENT
- 2.2 MAST / GLIDE PLATE / ROTATIONAL MAST MOUNT
- 2.3 OPTICAL ALIGNMENT HEAD
- 2.4 VEHICLE ALIGNMENT MIRROR
- 2.5 ALIGNMENT MIRROR *CALIBRATION*
- 2.6 FLOOR SLOPE LASER

3. OPERATION *Pg. 6*

- 3.1 ALIGNMENT BAY(s) PREPARATION
- 3.2 FLOOR SLOPE MEASUREMENT
- 3.3 VEHICLE PREPARATION, Prior to Alignment

4. HEADLAMP ALIGNMENT *PG. 7*

- 4.1 ALIGNMENT of OPTICAL HEAD TO VEHICLE
- 4.2 CENTERING on the HEADLAMP
- 4.3 SELECTING HEADLAMP PATTERN
- 4.4 ALIGNMENT of HEADLAMP PROCEDURE

5. LASER CALIBRATION / MAINTENANCE *Pg. 9*

- 5.1 LASER CALIBRATION
- 5.2 MAINTENANCE

6. FREQUENTLY ASKED QUESTIONS *Pg. 10*

WARRANTY *Pg. 11*

CUSTOMER SERVICE

888-884-8182

1. GENERAL

1.1 INTRODUCTION

The Model **CVA 3 EZ ISOColor** Visual Headlamp Alignment System is an economical optical alignment tool that functions under the same principle for accuracy and dependability of an aiming screen, with the added benefit of Color Defined Lamp Pattern and a Visual Assist meter, without the excessive use of valuable shop space and the confusion of vertical and horizontal lamp placement. System design and operation has been engineered with the technician in mind. The **CVA 3 EZ ISOColor** features Color Defined, Lamp Pattern Definition and a Visual Assist meter that facilitates headlamp alignment, with profitability and customer satisfaction the end result.

The Model **CVA 3 EZ** is designed, manufactured and serviced by **Symtech** Corporation, Olathe, Kansas, the industry leader in headlamp alignment technology to the service and body repair industries, the architect of the Model ELA 10, **ISOColor**, LCA 2 EZ Visual, HBA 5 and PLA 12 Electronic Headlamp Alignment systems and the AIM 200 Headlamp Intensity meter.

We are confident that the **CVA 3EZ ISOColor** will provide you with years of exceptional service. Thank you for selecting a **Symtech Safety by Design** product to address your headlamp alignment needs.

1.2 SYSTEM COMPONENTS



OPTICAL HEAD



FLOOR SLOPE LASER

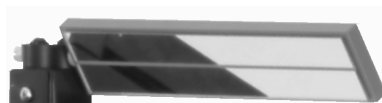

VEHICLE ALIGNMENT MIRROR

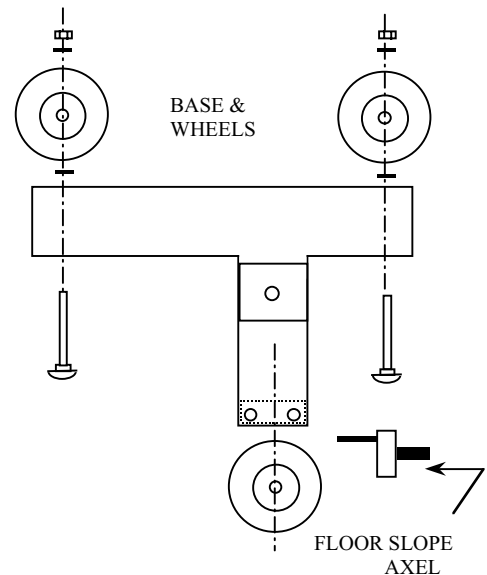

- Small Parts Package**
- 2 Large Nylon Washers
 - 2 $\frac{5}{16}$ Nylon Washers
 - 2 $\times \frac{1}{2}$ Nylon Spacers
 - 2 \times Nylon Spacers
 - 2 $\frac{5}{16}$ Self-Locking Nuts
 - 4 \times 20 Machine Screws
 - 1 Self Locking Nut
 - 1 Flat Washer
 - 2 Black, Flat Washer
 - 2 $\times 1.5$ Button head Cap Screws

- Large Parts Package**
- 2 $\frac{5}{16} \times 6$ Carriage Bolts
 - 1 Floor Slope Handle
 - 2 Wheels
 - 1 Wheel w/Floor Slope Eccentric
 - 1 Rotational Mast Bushing

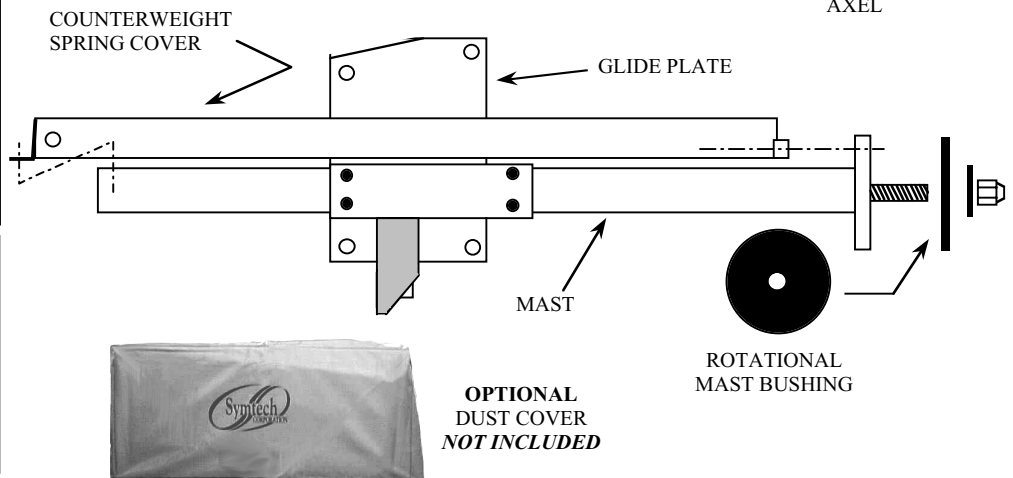

1.3 LASER WARNING

AVOID LOOKING DIRECTLY INTO LASER LIGHT — POSSIBLE EYE INJURY CAN OCCUR.



1.4 VISUAL ASSIST METER & SWITCH

The Visual Assist meter is an aide for positioning the headlamp pattern to its correctly designed position. While visually adjusting the headlamp into position, the Visual Assist meter will raise in numeric reading if adjustment is directed in the correct direction. Adversely, the meter reading will decrease if headlamp is adjusted in the incorrect direction. When the highest achievable reading is attained both vertically and horizontally, the headlamp will be positioned correctly.

The SELECTOR switch moves the Visual Assist meter function between High and Low Beam patterns. Make sure that the switch is in the correct location for the beam pattern to be aligned.



1.5 ISOColor LAMP PATTERN DEFINITION

ISOColor technology, unique to Symtech Products, colorizes the lamp pattern by designating a hue to the intensities of the headlamp. The headlamp pattern will appear on the screen with the highest intense portion of pattern being the most inner circle of color, with varying colors of intensity radiating outward.

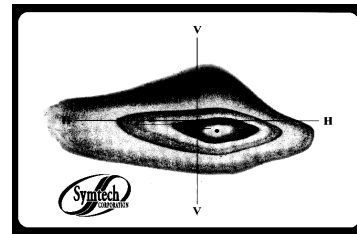

2. ASSEMBLY

Inspect all components of the CVA 3EZ system to assure that no damage has occurred during shipment, compare contents of package with that of the exploded view to make sure that no component has been inadvertently left out of packaging. If a component is missing, contact our customer service department at 888-884-8182 for an immediate replacement.

2.1 BASE / WHEEL ATTACHMENT

Place base of system on floor, or table with channel facing downward.

Insert a 5/16 x 6 carriage bolt into each of the holes noted, making sure that the square carriage bolt head seats securely into the square hole placement.

Complete wheel assembly by placing in order a large nylon washer, wheel, small nylon washer and self-locking 5/16 nut on carriage bolt.

Tighten self-locking nut snug against wheel, but not so tight as to hinder free wheel movement.

Insert floor slope eccentric and wheel into mounting block on base (rear wheel). Tighten friction bolt until floor slope eccentric can be moved, but not loose enough to move by itself.

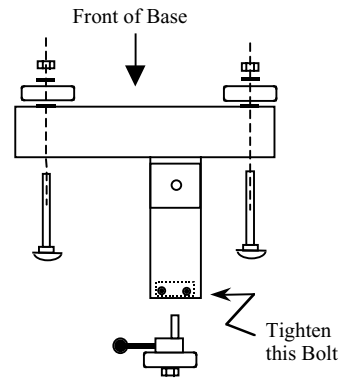

2.2 MAST / GLIDE PLATE / ROTATIONAL MAST MOUNT

The Mast, Counterweight Spring Cover and Spring are packaged as an assembly.

Remove attachment screw at top of mast spring cover.

Slide Glide Plate over end of mast, between mast and mast spring cover, ensuring that handle is pointed away from spring cover. Slide glide plate down over mast until the spring hook of the glide plate is even with the bottom of the spring inside of the mast spring cover. Place bottom of spring into spring hook, and reattach screw at top of mast spring cover.

Place rotation bearing over mast stud and insert rotational mast stud into base. Secure mast to base with 1/2 flat washer and self-locking nut. Tighten nut securely then back-off 1/2 turn, or until mast rotates freely with minor resistance.

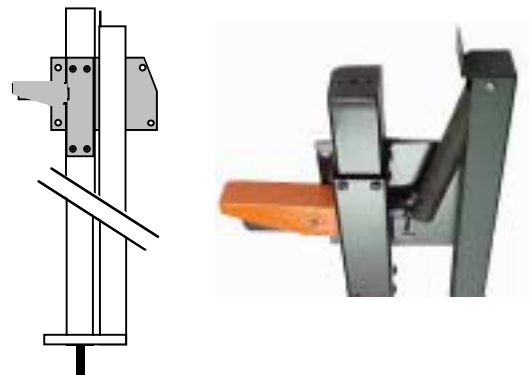

Move glide plate up and down the mast through its full motion, by depressing handle.

2.3 OPTICAL ALIGNMENT HEAD

Remove optical alignment head from shipping carton. Inspect for any damage that may have occurred during shipment i.e. lens, case, etc..

Attach optical alignment head to the mast glide plate by aligning mounting holes of glide plate with the holes in the optical head. Insert $_ \times 20 \times _$ allen head machine screws through glide plate, place a $_ \times _$ nylon spacers on each upper screws, place a $_ \times \frac{1}{2}$ nylon spacers on each lower screws, attach optical head and tighten securely.

Remove protective paper covering from viewing window on top of optical head.

Move optical head through the full range of movement to assure of smooth operation.

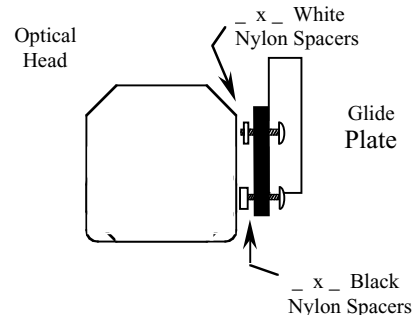
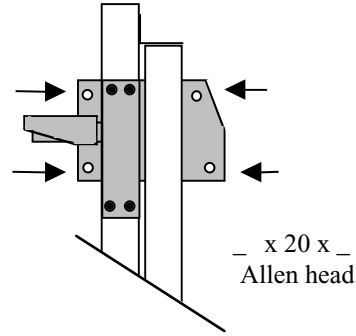

2.4 VEHICLE ALIGNMENT MIRROR

Vehicle alignment mirror assembly is enclosed in the accessories box.

NOTE: Mount mirror assembly so that unit is located directly over the optical head.

Insert 2, $_ \times 20 \times 1 \frac{1}{2}$ screws (Small Parts Package) into mirror calibration block and attach all to top of mast.

DO NOT TIGHTEN. Tighten to a tension that allows for sufficient movement during calibration. After calibration has been performed tighten securely.

NOTE: Sighting unit must be calibrated to the optical head prior to alignment of headlamps.



2.5 SIGHTING UNIT CALIBRATION

Calibration of sighting unit must be performed prior to alignment of headlamps.

Raise optical head of CVA 3EZ to the approximate center of travel of mast.

Turn the sighting unit until you can see the reflection of the front edge of the optical head. Line on mirror should line up with the front edge of the optical head.

If line does not line up with the front edge of optical head, rotate mirror assembly until line is parallel with front of optical head. Tighten screws.

It is important that periodical checking of calibration of the vehicle alignment mirror be performed, to assure customer satisfaction.

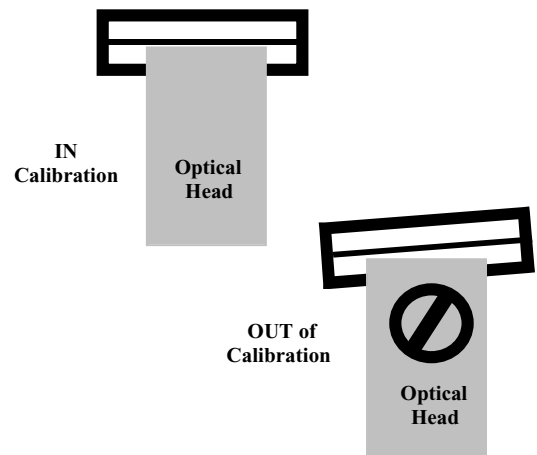

2.6 FLOOR SLOPE LASER

The floor slope laser assembly is factory calibrated, **DO NOT** turn the level adjustment set screw which is at the back of laser assembly.

The laser is used for floor slope measurement only. Remove laser after floor slope measurements have been recorded

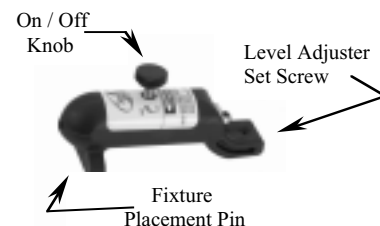

Remove floor slope laser from packaging and insert front fixture placement pin into hole on top and at rear of the optical head, also there is an indentation provided for the height adjustment screw to rest within.

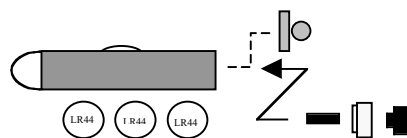

Activate the laser by turning front knob clockwise (CAUTION: Excessive turning may damage laser ON/OFF mechanism) to assure of functionality, turn off laser. No further adjustment is required.

NOTE: Should calibration of the laser become necessary in the future, Refer to LASER CALIBRATION . Calibration, Section 5.1, Pg. 9.

Laser Battery Replacement

Unscrew back of laser and replace batteries with three (3), LR 44 button batteries. Reverse process for assembly.

After battery replacement, CALIBRATION MAY BE REQUIRED.

3. OPERATION PROCEDURES

3.1 PREPARATION, ALIGNMENT BAY(S)

Prior to any headlamp alignment using the CVA 3EZ, the floor slope of the bay, or bays must be determined, this is done by using the floor slope laser assembly and noting the position of the rear floor slope wheel.

If the correct floor slope of the bay is not adjusted prior to any headlamp alignment, the technician will align the headlamps in a higher, or lower position than what is correct. The CVA 3EZ must be on the same plain as the vehicle that is to be aligned, if the vehicle is positioned on a floor that has an upward slope running from fore to aft of vehicle, then the CVA 3EZ must be adjusted to have the same slope.

3.2 FLOOR SLOPE MEASUREMENT

Tool Required: **Tape Measure or Ruler**

Move the CVA 3EZ to the service bay to be used for headlamp alignment and place the CVA 3EZ at the front of the vehicle, off to one side. If multiple bays are to be used, procedure for determining floor slope will need to be performed in each bay and recorded.

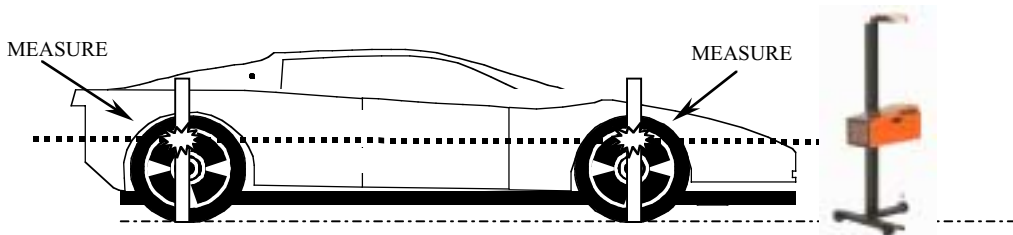

Lower the optical head to the bottom of the mast. Adjust optical head by rotating eccentric wheel at rear of base until level vial registers level. Turn the laser on.

At the center point of the front wheel of the vehicle measure the distance from the floor to the point where the laser strikes the tape measure, RECORD.

Move to the center point of the rear wheel of vehicle and measure the point where the laser strikes the tape measure, RECORD.

If the measurements at the front and rear wheels are not equal, the bay has a slope.

Rotate the floor slope handle on rear wheel until equal measurements are registered at the front and rear wheels.

NOTE: When rotating eccentric axle on CVA 3EZ, both measurements will change at front and rear vehicle



wheels, to achieve equal measurements, more than one eccentric axle change may be required.

Note the number on the floor slope gauge and record that number along with the bay designate on floor slope sticker provided. Repeat procedure for other bays and record.

NOTE: After measurements have been taken, remove laser and store in a secure place

3.3 VEHICLE PREPARATION

- Remove ice or mud from under the fenders.
- Set the tire inflation to the values recommended by the manufacturer.
- See that there is no load in the vehicle unusual to normal driving conditions.
- Check vehicle springs for sag or broken leaves.
- Check function of any automatic leveling systems and specific manufacturers instructions pertaining to vehicle preparation for headlamp alignment.
- Clean lenses, check for bulb burnout, broken mechanical aiming pads, moisture in lens and proper beam switching.
- Stabilize suspension by rocking vehicle sideways.

4. HEADLAMP ALIGNMENT

4.1 ALIGNMENT OF OPTICAL HEAD TO VEHICLE

Place the CVA 3EZ in front of the first headlamp to be aligned. Once the CVA 3EZ is in place, the lens of the optical head should be approximately 12 inches (+/- 6 inches) from the face of the headlamp.

Set the floor slope of the eccentric wheel for the bay in which the vehicle has been parked.

Rotate the vehicle alignment mirror so that the reflection of the front of the vehicle can be seen in the mirror. Locate two (2) common points on or under the hood to align the line in the mirror on.

NOTE: Points can be hood stops, radiator supports, points of fender, etc.

While looking at the mirror, align the line of the sighting unit on the two common points by rotating the optical head.

The CVA 3EZ is now aligned with the vehicle. Repeat the alignment process for each lamp.

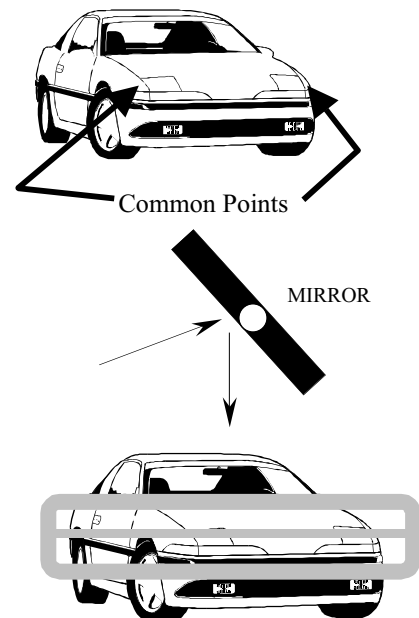

4.2 CENTERING on the HEADLAMP

Turn headlamps on. Move optical head up, or down to the center of the headlamp. Position of center of the headlamp is approximate; a ± 2 allowance is acceptable.

TRICK: A method to determining if position is greater than 2 is by observing the Visual Assist meter for highest reading while moving CVA 3EZ left/right and up/down in front of the headlamp to be aligned.

4.3 SELECTING HEADLAMP PATTERN

Not all headlamps are created alike and different vehicles may have different design patterns. To be certain of the lamp pattern, a designate is located on the lamp at the bottom of the lens. Patterns of lamps that may be aligned with the CVA 3EZ are;

- **SAE HIGH BEAM:** All high beam lamps. Highest intensity point is centered on the Horizontal / Vertical axis.
- **SAE LOW BEAM:** All low beam lamps manufactured prior to 1999. After 1999, some vehicles could have headlamp patterns that are VOR or VOL. The high intensity area is located in the lower right hand quadrant.
- **FOG LAMPS:** All fog lamps the top of the high intensity area is located 4 down and centered on the Vertical axis.
NOTE: DO NOT use Visual Assist Meter for alignment assistance for Fog Lamps
- **SAE LOW BEAM VOR (Visual Optical Right):** Low beam lamps manufactured after 1999, some vehicles. The high intensity area is located in the lower right hand quadrant and the beam pattern is aligned by placing the right upper portion of the beam pattern on the Horizontal axis.
NOTE: Visual Assist meter can be used when aligning this lamp type if the lamp is switched to HIGH beam and aligned as High beam procedure.
- **SAE LOW BEAM VOL (Visual Optical Left):** Low beam lamps manufactured after 1999, some vehicles. The high intensity area is located in the lower right hand quadrant and the beam pattern is aligned by placing the left upper portion of the beam pattern on the .4 Degree (2.096) Down Horizontal axis.
NOTE: Visual Assist meter can be used when aligning this lamp type if the lamp is switched to HIGH beam and aligned as High beam procedure.

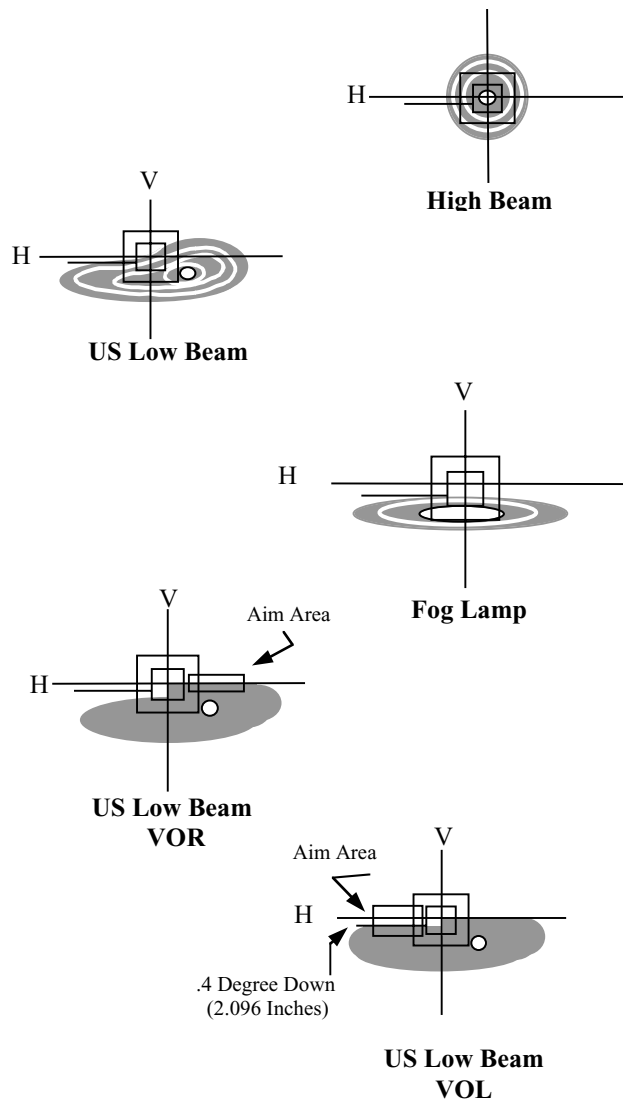

4.4 ALIGNMENT OF HEADLAMP PROCEDURE

- Locate CVA 3EZ approximately 12 inches from in front of the lamp to be aligned.
- Position CVA 3EZ in front of first lamp to be aligned.
- Align CVA 3EZ to vehicle by aligning two points under or above the hood with line in alignment mirror.
- Select headlamp pattern and press Visual Assist Switch to lamp type, **HIGH BEAM** or **LOW BEAM**.



- While viewing aim screen and Visual Assist meter, adjust headlamp to position that appears as graphic illustration of headlamp pattern selected and Visual Assist meter has reached its highest achievable reading for that lamp.

NOTE: Graphics on aiming screen denote position of lamp position in inches. Outer box

Headlamp Alignment Procedure

<ol style="list-style-type: none"> 1. Position CVA 3EZ in Front of first lamp to be Aligned. 2. Adjust Floor Slope to Recorded Bay Setting. 3. Square CVA 3 to Vehicle by Aligning Two Common Points with Line in Sighting Mirror. 4. Press <i>Visual Assist</i> Switch to Lamp Beam Type. 	<ol style="list-style-type: none"> 5. Adjust by Centering the Inner Most Colored Ring of Lamp Pattern over circle designated by selected Beam Type Arrow and the Visual Assist Meter to Highest Reading. 6. Move CVA 3 to Next Lamp and Repeat Steps 3 Through 5.
--	---

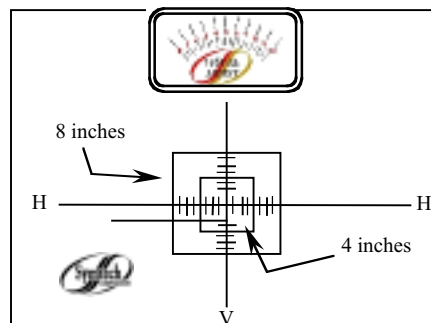

denotes 8 inches, inner box denotes 4 inches. Each hash mark denotes 1 inch increment.

- Repeat steps 2 through 4 for remaining lamps.

6. LASER CALIBRATION / MAINTENANCE

5.1 FLOOR SLOPE LASER CALIBRATION

LASER IS CALIBRATED AT THE FACTORY PRIOR TO SHIPMENT

Calibration Required ONLY if Rear- LASER Adjustment Set Screw has been tampered with

Tools Required: **Elevated Surface** (wheel alignment, frame machine)

Level (carpenters level or other means)

6 Straight Edge (board or other means)

5/64 Allen Wrench

Locate an elevated surface and lay the straight edge on surface facing away from optical head. Check straight edge for level, shim if necessary.

Move **CVA 3EZ** to end of straight edge, turn on the laser and adjust height of optical head so that the mounted laser will shoot down the straight edge.

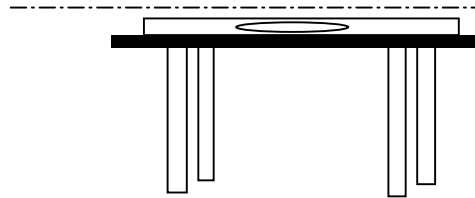

Adjust the rear floor slope wheel until the level in the optical head is centered. Readjustment of height of optical block may be necessary.

Adjust the rear height adjustment set screw of the laser assembly (Lock Tight has been installed on screw at factory, minor pressure should break seal) till laser is viewed at both ends of straight edge equally.

Laser is now calibrated, installing lock tight or other adhesive to adjustment screw is recommended.

5.2 MAINTENANCE

The **CVA 3EZ** will provide years of trouble free operation with minimum maintenance, however, care should be taken in the day-to-day usage of this service instrument. Following are areas that should be periodically checked and serviced;

- Check wheel axles nuts for tightness, minor lubrication is recommended.
- Check the optical head mounting bolts for tightness and tighten as required.
- Check all other mounting screws, bolts and nuts for tightness.
- Clean the mast area where the brake rides with a mild detergent to assure of secure holding.
- Clean the front lens, sighting unit and viewing window with a mild detergent being careful to use a non-abrasive soft cloth.

6. FREQUENTLY ASKED QUESTIONS

Question: Level in optical head is not centered during alignment procedure?

Answer: Level vial is used ONLY when checking the calibration of the floor slope laser.

Question: The high intensity (hot spot) area of the headlamp how is this determine?

Answer: All lamps are legislated to be created equal, but this has proven not to be the case. The **CVA 3EZ ISOColor** incorporates color definition technology that defines the high intensity zone for ease of alignment. The most inner circle of color is the high intensity zone, this area should be centered over the area that is designated by the arrow of the specific lamp pattern being aligned.

Question: Do I have to check for floor slope every time I perform a headlamp alignment?

Answer: Floor slope need only be performed one time in each bay that the **CVA 3EZ** is to be used. When determining the floor slope, record the reading of the rear eccentric wheel on the sticker provided, Each time you are in that bay, refer to the sticker and adjust the rear eccentric to that measurement.

Question: I cannot attain equal readings at the front wheel and the rear wheel areas when determining the floor slope.

Answer: The only time that this can occur is when the shop bay has an abnormally excessive angle of slope. The most frequent problem with determining floor slope is patience in adjusting until the measurements are equal. A TRICK to assist in making this measurement is to first measure the height of the laser at the optical head. Then turn the eccentric wheel until the laser reading matches the measurement of the optical head at the rear wheel area. Check readings at front and rear wheel areas and make, if any, minor adjustments to equal measurements. RECORD READING OF ECCENTRIC WHEEL FOR FUTURE REFERENCE.

Question: What do I use as reference when squaring the CVA 3EZ to the vehicle and do I need to square again when moving from one lamp to another?

Answer: It is always recommended to check the alignment of the sight unit to the vehicle for every lamp to be aligned. Some reference points that are prominent on most vehicles are the grill, hood line, radiator support, hood bumpers and common assembly point bolts. Always pick two points that are of equal proportion.

Question: Can the Visual Assist meter measure light intensity?

Answer: The Visual Assist meter DOES NOT MEASURE LIGHT INTENSITY . It assists in locating the highest value reading of that particular lamp. If a light intensity meter is an instrument your facility would like to procure, SYMTECH offers the AIM 200 , a hand held, self-contained precision instrument specifically designed for measuring automotive light intensities.

Question: Why does the Visual Assist meter have a higher reading on one side of the car than the other?

Answer: Most vehicles will have lamps of varying intensity and patterns. Just use the meter and adjust to the highest value reading for that particular lamp.

Question: Can I use the Visual Assist meter to help line up the optical head with the headlamp?

Answer: YES. While observing the meter, roll the **CVA 3EZ** back and forth horizontally and raise and lower the optical head vertically until you achieve the highest metered reading.

Question: How do I change the batteries in the Visual Assist meter?

Answer: The meter does not have batteries, power is provided by the light of the headlamp.

Question: Is there a calibration procedure for the Visual Assist meter?

Answer: NO calibration of meter is required.

WARRANTY

All **Symtech Corporation** products are warranted to be free from defects in material and workmanship under normal user service for a period of one year after the sale of the product. Exception to this policy will be individually evaluated and must be approved by **Symtech** Corporate. The sole obligation under this warranty shall be to repair, or replace any defective products or parts thereof, which upon examination are deemed to the seller's satisfaction to be defective.

The warranty shall not apply to any product, which has been subject to misuse, negligence, or accident. The seller shall not be responsible for any special or consequential damages and the warranty as set forth is in lieu of all other warranties, either expressed or implied. However, the seller makes no warranty of merchantability in respect to any products for any particular purpose other than that stated in literature and any applicable manufacturer shop or service manuals referred to therein, including any subsequent service bulletins.

The **CVA 3, ISOColor** Optical Headlamp Alignment System has been tested by an AMECA accredited independent laboratory and found to comply with the Society of Automotive Engineers (SAE) recommended practices prescribed in standards j599, j600, j1383 and j1735.

The seller makes no claims or warranties of any kind that the Symtech Corporation Optical Headlamp Alignment Systems will align headlamps that do not conform to Society of Automotive Engineers recommended practices described in j599, j600, j1383, and j1735.

