

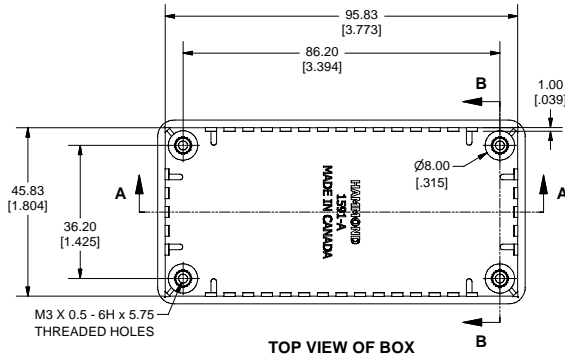

SIDE VIEW OF BOX

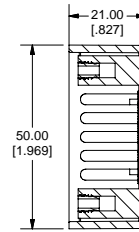

TOP VIEW OF BOX



SECTION B-B

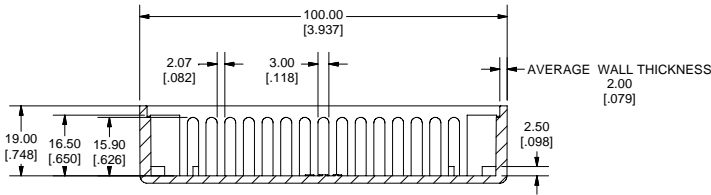
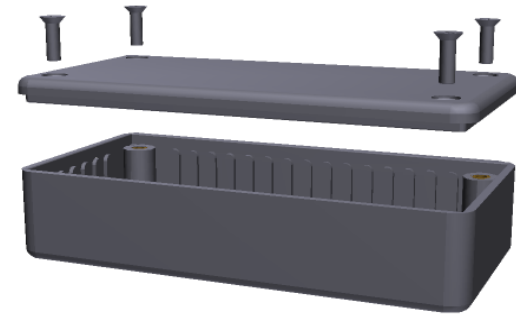

SECTION A-A

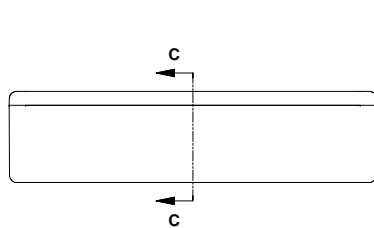

SIDE VIEW OF ASSEMBLY

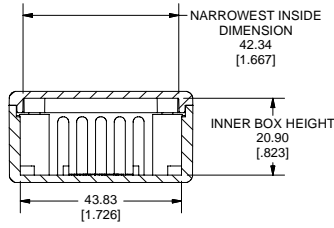

SECTION C-C

Note:  
Enclosures can be Factory Modified ( Milling, Drilling, Printing etc. )  
Contact Factory [mjm@hammondmfg.com](mailto:mjm@hammondmfg.com) for quotes  
Solid models of this enclosure available in STEP or IGES Format.

**PART NUMBERS**

1591A Enclosures		
Material	Colour	Part Number
FR ABS UL94 - V0	Beige	1591ABG
	Black	1591ABK
	Blue	1591ABU
	Grey	1591AGY
GP ABS	Black	1591ASBK
	Grey	1591ASGY
	Ice Blue	1591ATBU
Translucent Polycarbonate	IR Red	1591ATRD
	Crystal Clear	1591ATCL

**Accessories**

	Description	Part Number
Universal Use	PC Board Card Adapters	See Accessories Section
	Clear Lids - clear, flame retardant polycarbonate - Lid ONLY	1591AC
	Replacement Screws, Flat Head Phillips Nickel Plated Pkg of 100	1591MS100 1591MS100BK (Black)
GP ABS	Self Tapping Pkg of 100	1591TS100 1591TS100BK (Black)

**Recommended Torque on Fasteners (no lubrication)**

M3 - 0.5 x 10mm Screws	30-40 cN*m
#4 x 0.5 Screws	30-40 cN*m

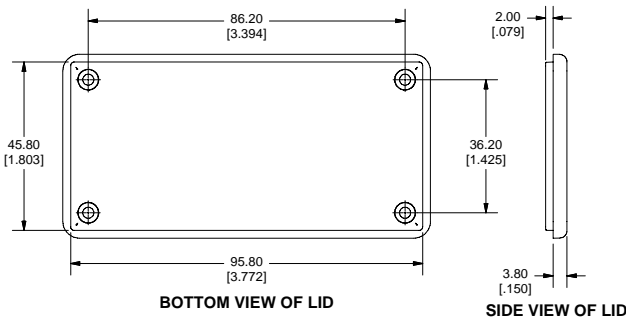

BOTTOM VIEW OF LID

SIDE VIEW OF LID

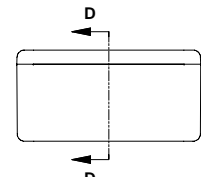

END VIEW OF ASSEMBLY

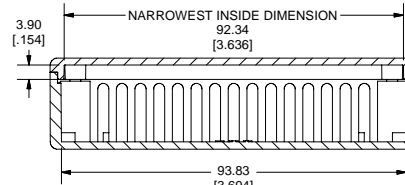

SECTION D-D

