

3-IN-1 POKER TABLE ASSEMBLY INSTRUCTIONS



**Please Do Not Hesitate to
Contact Our Consumer Hotline
at 800-759-0977
with Any Questions That May
Arise During Assembly or
Use of This Product!**

THANK YOU!

Thank you for purchasing this product. We work around the clock and around the globe to ensure that our products maintain the highest possible quality. However, in the rare case of issues during assembly or use of this product, please contact our Consumer Hotline at **800-759-0977** for immediate assistance before contacting your retailer. Please read the warranty information at the back of these assembly instructions for further details.

ASSEMBLY TIPS

IMPORTANT! PLEASE READ THESE ASSEMBLY INSTRUCTIONS IN ENTIRETY BEFORE ASSEMBLING YOUR PRODUCT.

1. Find a clean, level surface to begin the assembly of your game table. We recommend that two adults work together to assemble this bench. You may want to carefully cut or tear the four corners of the box so that the bottom of the box can be used as your work surface.
2. Remove all of the contents from box and verify that you have all of the parts shown on the Parts List before you begin assembly. **Note: Some parts may be pre-installed or pre-assembled.**
3. Some figures or drawings may not look exactly like product.
4. **When installing parts that have more than one screw or bolt, hand tighten all screws or bolts in place before final tightening with screwdriver or wrench.**
5. Electric screwdrivers may be helpful during assembly; however, please set a **low torque** and use extreme caution because screws may be stripped or overtightened, resulting in damaged parts, if the electric screwdriver's torque is set too high.

WARNINGS!

READ AND FOLLOW ALL ASSEMBLY, OPERATION AND SAFETY INSTRUCTIONS CAREFULLY.

**CHOKER HAZARD - THIS ITEM MAY CONTAIN SMALL BALLS AND PARTS
NOT SUITABLE FOR CHILDREN UNDER 3 YEARS OF AGE.**

CARE AND USE

1. This product is intended for **INDOOR** use only.
2. Do **NOT** drag the table when moving it, as this will damage the legs.

3-IN-1 DARK OAK POKER TABLE - NG2351T



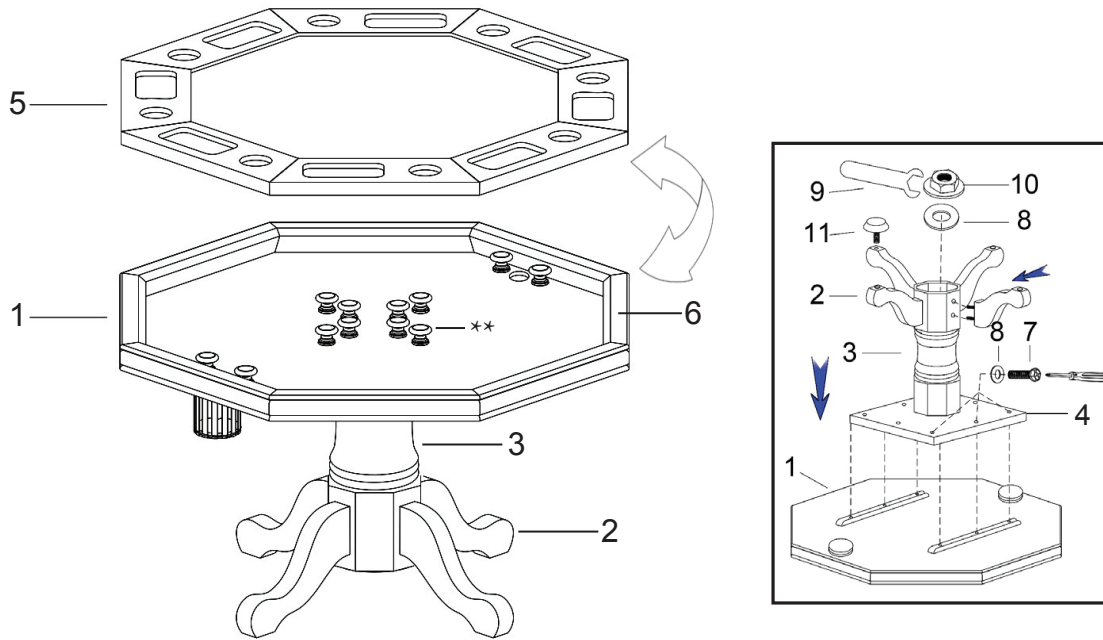







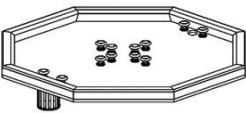

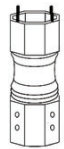
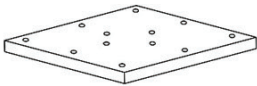
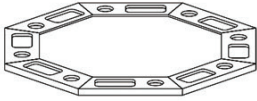
Parts List

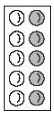

** Replacement bumper rings are available as NGP23221 for red, and NG23231 for white

Illustrations Not to Scale

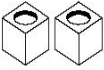
PARTS

<p>#1 NGP23001</p>  <p>TABLE BODY 1 pc</p>	<p>#2 NGP23011</p>  <p>LEG 4 pcs</p>	<p>#3 NGP23021</p>  <p>PEDESTAL 1 pc</p>	<p>#4 NGP23031</p>  <p>PLATE 1 pc</p>	<p>#5 NGP23041</p>  <p>TABLE TOP 1 pc</p>
<p>#6 NGP2305</p>  <p>TABLE PROTECTOR 8 pcs</p>	<p>#7 NGP23311*</p>  <p>BOLT 6 pcs</p>	<p>#8 NGP23311*</p>  <p>FLAT WASHER 18 pcs</p>	<p>#9 NGP23311*</p>  <p>WRENCH 1 pc</p>	<p>#10 NGP23311*</p>  <p>NUT 12 pcs</p>
<p>#11 NGP23191</p>  <p>LEG LEVELER 4 pcs</p>	<p>#12 NGP5698</p>  <p>BUMPER POOL BALLS 1 SET</p>	<p>#13 NGP5699</p>  <p>BUMPER POOL CUE STICK 2 pcs</p>	<p>#14 NGP5077</p>  <p>CHALK 2 pcs</p>	<p>#15 NGP5073</p>  <p>BRUSH 1 pc</p>

***HARDWARE PACK - NGP23311 includes parts 7, 8, 9 & 10**

3-IN-1 DARK OAK POKER CHAIR - NG2351C



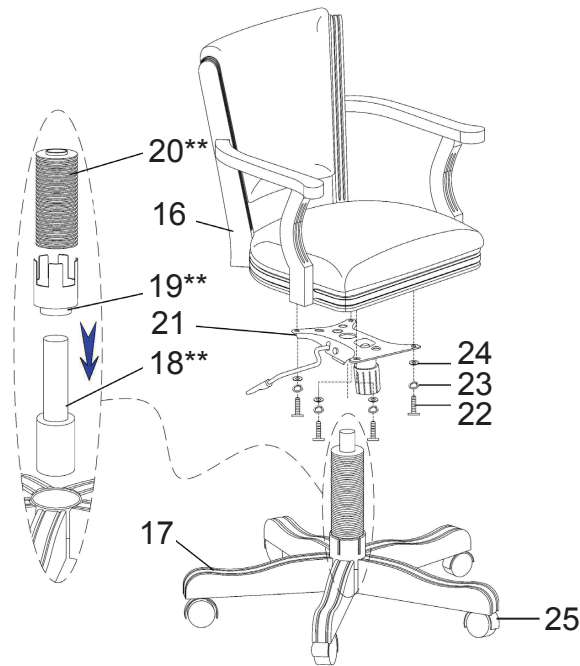





Parts List

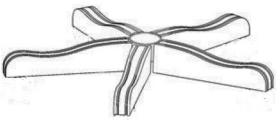

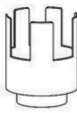
** Parts 18, 19 and 20 are packaged as set

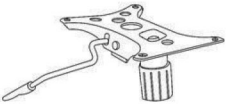
Illustrations Not to Scale

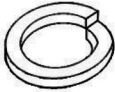
PARTS

<p>#16 NGP23441</p>  <p>SEAT 1 pc</p>	<p>#17 NGP23291</p>  <p>BASE 1 pc</p>	<p>#18 NGP2324</p>  <p>SEAT LIFT * 1 pc</p>	<p>#19 NGP2324</p>  <p>BASE CAP * 1 pc</p>	<p>#20 NGP2324</p>  <p>LIFT COVER * 1 pc</p>
<p>#21 NGP2327</p>  <p>SEAT ADJUSTER 1 pc</p>	<p>#22 NGP23451*</p>  <p>BOLT 4 pcs</p>	<p>#23 NGP23451*</p>  <p>LOCK WASHER 4 pcs</p>	<p>#24 NGP23451*</p>  <p>FLAT WASHER 4 pcs</p>	<p>#25 NGP2330</p>  <p>CASTER 5 pcs</p>

***HARDWARE PACK - NGP23451 includes parts 22, 23 & 24**

3-IN-1 WALNUT POKER TABLE - NG2366T



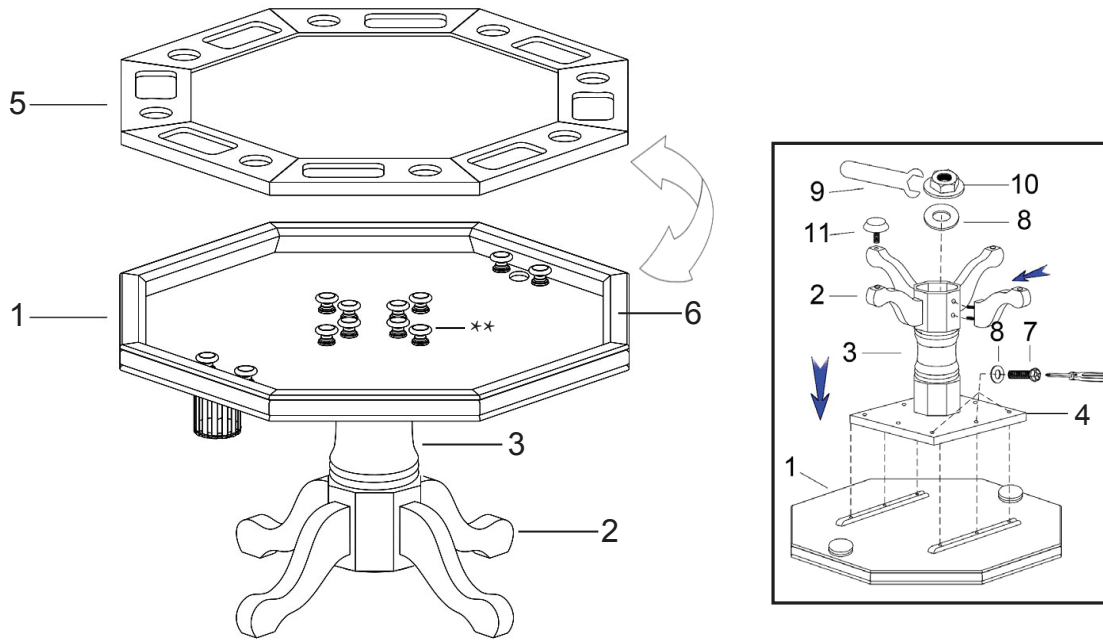







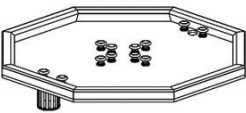

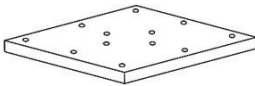
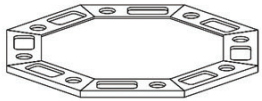
Parts List

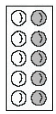

** Replacement bumper rings are available as NGP23221 for red, and NG23231 for white

Illustrations Not to Scale

PARTS

#1 NGP23071  TABLE BODY 1 pc	#2 NGP23081  LEG 4 pcs	#3 NGP23091  PEDESTAL 1 pc	#4 NGP23101  PLATE 1 pc	#5 NGP23111  TABLE TOP 1 pc
#6 NGP2305  TABLE PROTECTOR 8 pcs	#7 NGP23311*  BOLT 6 pcs	#8 NGP23311*  FLAT WASHER 18 pcs	#9 NGP23311*  WRENCH 1 pc	#10 NGP23311*  NUT 12 pcs
#11 NGP23191  LEG LEVELER 4 pcs	#12 NGP5698  BUMPER POOL BALLS 1 SET	#13 NGP5699  BUMPER POOL CUE STICK 2 pcs	#14 NGP5077  CHALK 2 pcs	#15 NGP5073  BRUSH 1 pc

***HARDWARE PACK - NGP23311 includes parts 7, 8, 9 & 10**

3-IN-1 WALNUT POKER CHAIR - NG2366C



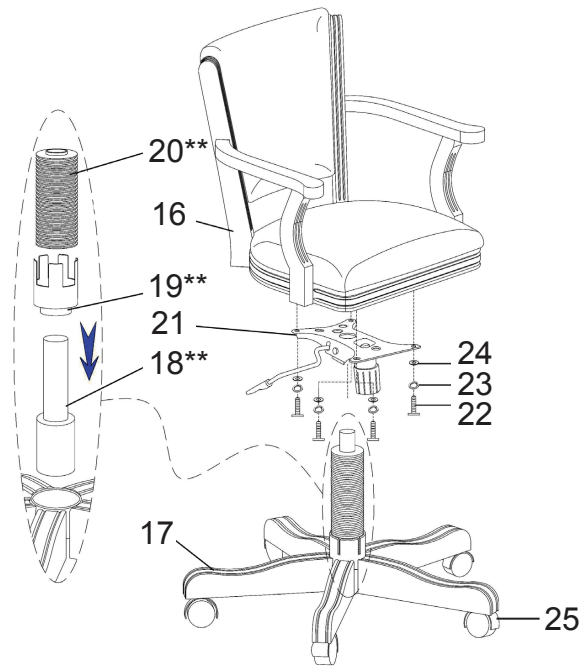





Parts List

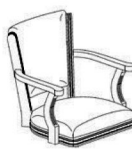
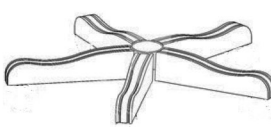

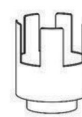
** Parts 18, 19 and 20 are packaged as set

Illustrations Not to Scale

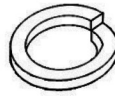
PARTS

<p>#16 NGP23461</p>  <p>SEAT 1 pc</p>	<p>#17 NGP23421</p>  <p>BASE 1 pc</p>	<p>#18 NGP2324**</p>  <p>SEAT LIFT 1 pc</p>	<p>#19 NGP2324**</p>  <p>BASE CAP 1 pc</p>	<p>#20 NGP2324**</p>  <p>LIFT COVER 1 pc</p>
<p>#21 NGP2327</p>  <p>SEAT ADJUSTER 1 pc</p>	<p>#22 NGP23451*</p>  <p>BOLT 4 pcs</p>	<p>#23 NGP23451*</p>  <p>LOCK WASHER 4 pcs</p>	<p>#24 NGP23451*</p>  <p>FLAT WASHER 4 pcs</p>	<p>#25 NGP2330</p>  <p>CASTER 5 pcs</p>

***HARDWARE PACK - NGP23451 includes parts 22, 23 & 24**

ASSEMBLY INSTRUCTIONS - TABLE

1. Attach PLATE #4 to PEDESTAL #3 with NUT #10 and FLAT WASHER #8.

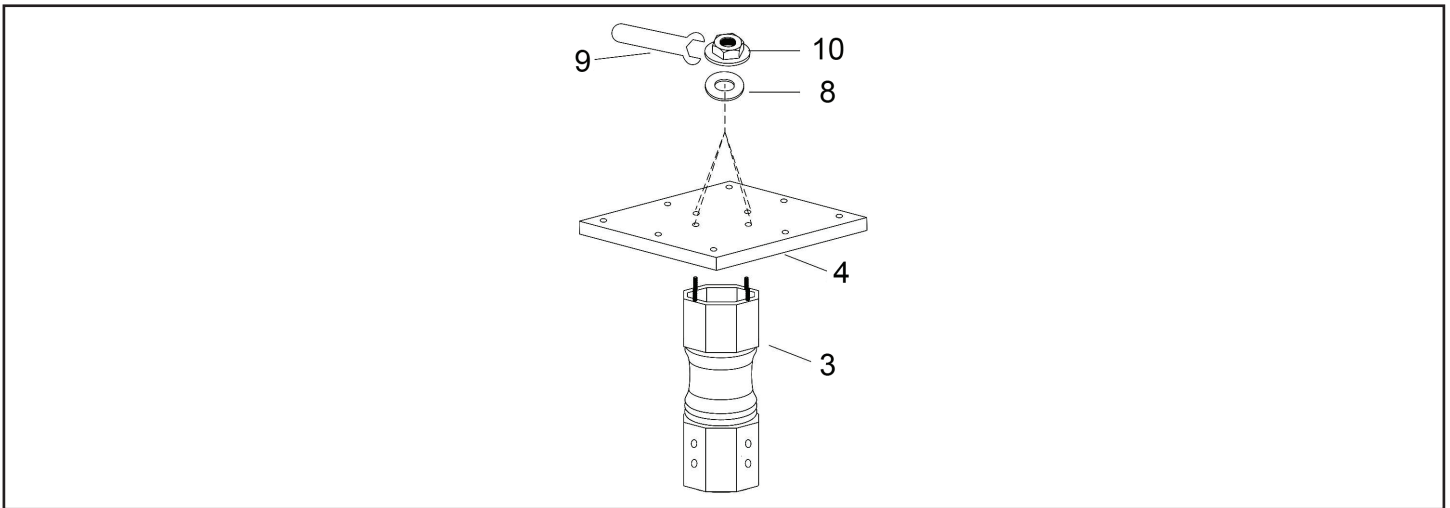

2. Attach assembled PEDESTAL to the bottom of the TABLE BODY #1 with BOLT #7 and FLAT WASHER #8.

3. Attach LEGS #2 to PEDESTAL with NUT #10 and FLAT WASHER #8. Thread one LEG LEVELER #11 onto each LEG.

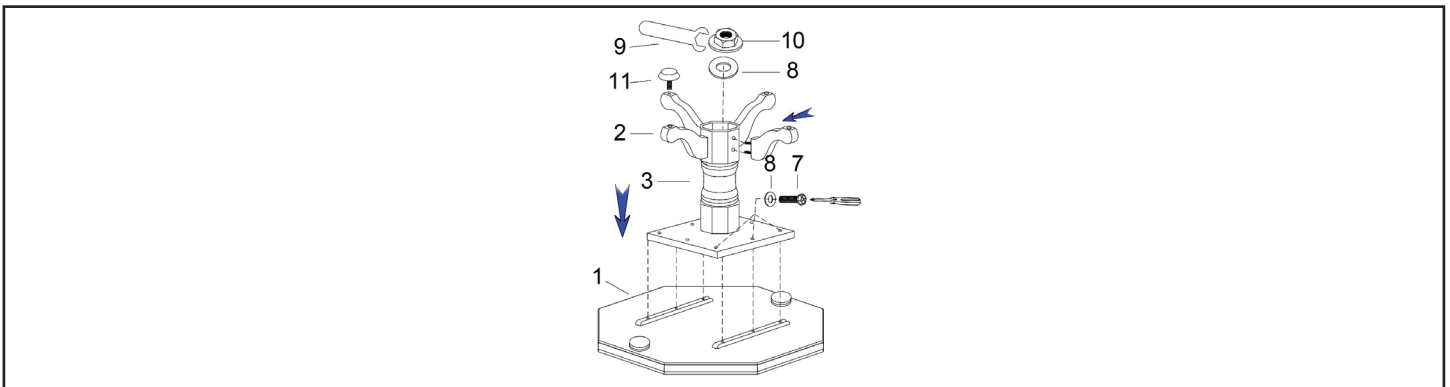

4. Carefully turn table over. Place TABLE TOP #5 on top of assembled TABLE.

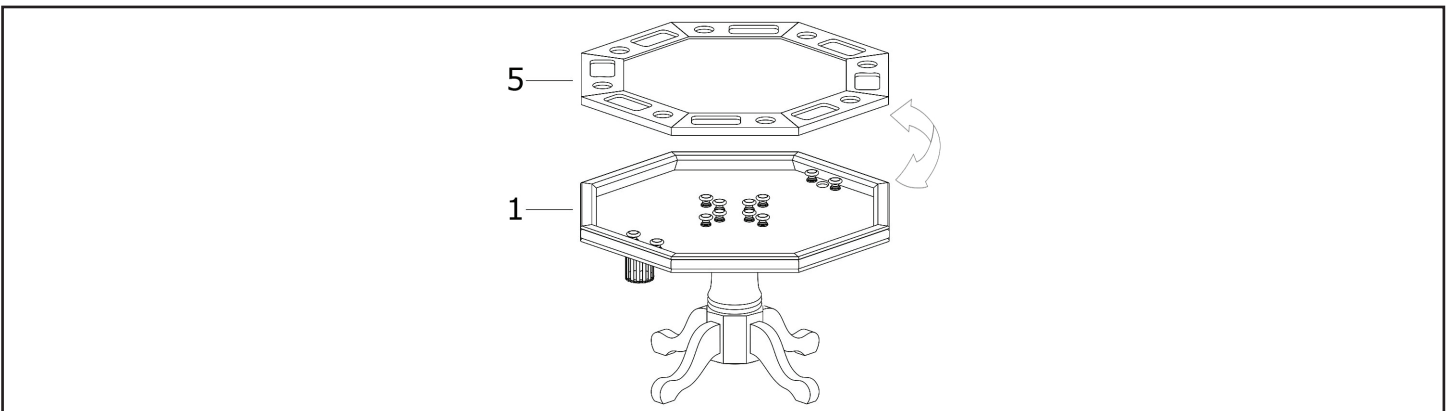

ASSEMBLY INSTRUCTIONS - CHAIR

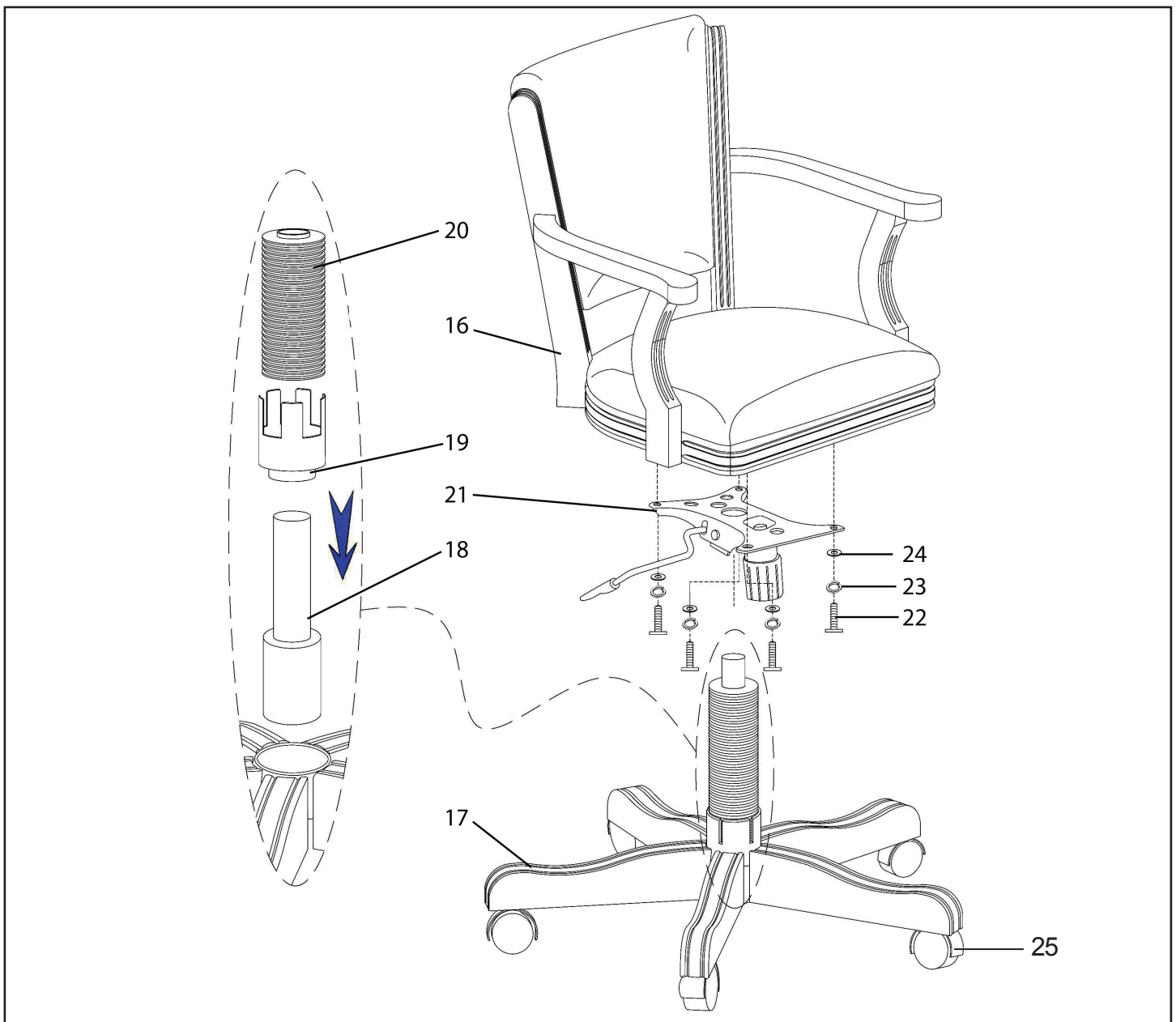

1. Insert CASTERS #25 into BASE #17. Attach SEAT LIFT #18, BASE CAP #19 and LIFT COVER #20 to BASE #17.

2. Attach SEAT ADJUSTER #21 to the bottom of SEAT #16 with BOLT #22, LOCK WASHER #23 and FLAT WASHER #24. Note: The tilt tension dial should face towards the front of the chair.

3. Attach assembled SEAT to assembled BASE - top of SEAT LIFT fits into corresponding hole in SEAT ADJUSTER.

180-DAY LIMITED WARRANTY

This product is warranted to the original purchaser to be free from defects in material or workmanship for a period of 180 days from the date of the original retail purchase.

This warranty does not cover defects or damage due to improper installation, alteration, accident or any other event beyond the control of the manufacturer. Defects or damage resulting from misuse, abuse or negligence will void this warranty. This warranty does not cover scratching or damage that may result from normal usage.

This product is not intended for institutional or commercial use; the manufacturer does not assume any liability for such use. Institutional or commercial use will void this warranty.

This warranty is nontransferable and is expressly limited to the repair or replacement of the defective product. During the warranty period, the manufacturer shall repair or replace defective parts at no cost to the purchaser. Shipping charges and insurance are not covered and are the responsibility of the purchaser. Labor charges and related expenses for removal, installation or replacement of the product or components are not covered under this warranty.

The manufacturer reserves the right to make substitutions to warranty claims if parts are unavailable or obsolete.

The manufacturer shall not be liable for loss of use of the product or other consequential or incidental costs, expenses or damages incurred by the consumer of any other use. The user assumes all risk of injury resulting from the use of this product.

This warranty is expressly in lieu of all other warranties, expressed or implied, including warranties of merchantability or fitness for use to the extent permitted by Federal or state law. Neither the manufacturer nor any of its representatives assumes any other liability in connection with this product.

All warranty claims must be made through the retailer where the product was originally purchased. A purchase receipt or other proof of date of purchase will be required to process all warranty claims. The model number and part numbers found within the assembly instructions will be required when submitting any parts requests or warranty claims.

For further warranty information or inquiries, please call 800-759-0977

TABLE DE POKER 3-en-1 INSTRUCTIONS D'ASSEMBLAGE



Contactez notre
service à la clientèle au
800-759-0977
avec des questions sur le montage
ou l'utilisation de ce produit.

MERCI!

Merci d'avoir acheté notre produit. Nous travaillons 24 heures sur 24, partout dans le monde, à garantir que nos produits sont de la meilleure qualité possible. Toutefois, dans les rares cas de problèmes lors du montage ou de l'utilisation de ce produit, se il vous plaît communiquer avec notre service à la clientèle au **800-759-0977** pour une aide immédiate avant de contacter votre revendeur. Pour obtenir de plus amples renseignements, veuillez lire l'information relative à la garantie au verso de ce guide d'instructions.

INSTRUCTIONS D'ASSEMBLAGE

IMPORTANT! VEUILLEZ LIRE, EN ENTIER, TOUTES LES INSTRUCTIONS AVANT D'ASSEMBLER VOTRE PRODUIT.

1. Trouver une surface propre et plane, pour commencer le montage de votre table de jeu. La table s'assemble à l'envers pour être ensuite retournée sur ses pieds, une fois l'assemblage complété. Cette table est lourde et nécessite au moins deux adultes forts pour la soulever et la retourner.
2. Retirez le contenu de la boîte, avant de commencer l'assemblage, assurez-vous d'avoir toutes les pièces telles que listées et illustrées au tableau d'identification. ***Avis : certaines pièces sont préassemblées ou préinstallées.***
3. Certaines illustrations ou dessins peuvent ne pas ressembler au produit que vous avez acheté.
4. ***Quand vous fixez en place une pièce avec plus d'une vis ou écrou, veuillez, en premier, les visser à la main et terminer la fixation avec un tournevis ou une clé.***
5. Un tournevis électrique peut être utile lors de l'assemblage, mais veuillez le régler à ***basse torque*** et l'utiliser avec prudence; si la torque est trop élevée, la vis peut se défaire ou être trop serrée.

AVERTISSEMENTS!

LIRE TOUTES LES INSTRUCTIONS D'ASSEMBLAGE ET LES CONSIGNES DE SÉCURITÉ ATTENTIVEMENT.

RISQUE D'ÉTOUFFEMENT – CERTAINS ÉLÉMENTS DU PRODUIT CONTIENNENT DE PETITES PIÈCES - NE CONVIENT PAS À UN ENFANT DE MOINS DE TROIS ANS.

ENTRETIEN ET USAGE

1. Ce produit doit être utilisé **À L'INTÉRIEUR** seulement.
2. **NE JAMAIS** déplacer la table en la traînant, cela pourrait endommager les pieds.

TABLE DE POKER 3-en-1 CHÊNE FONCÉ - NG2351T



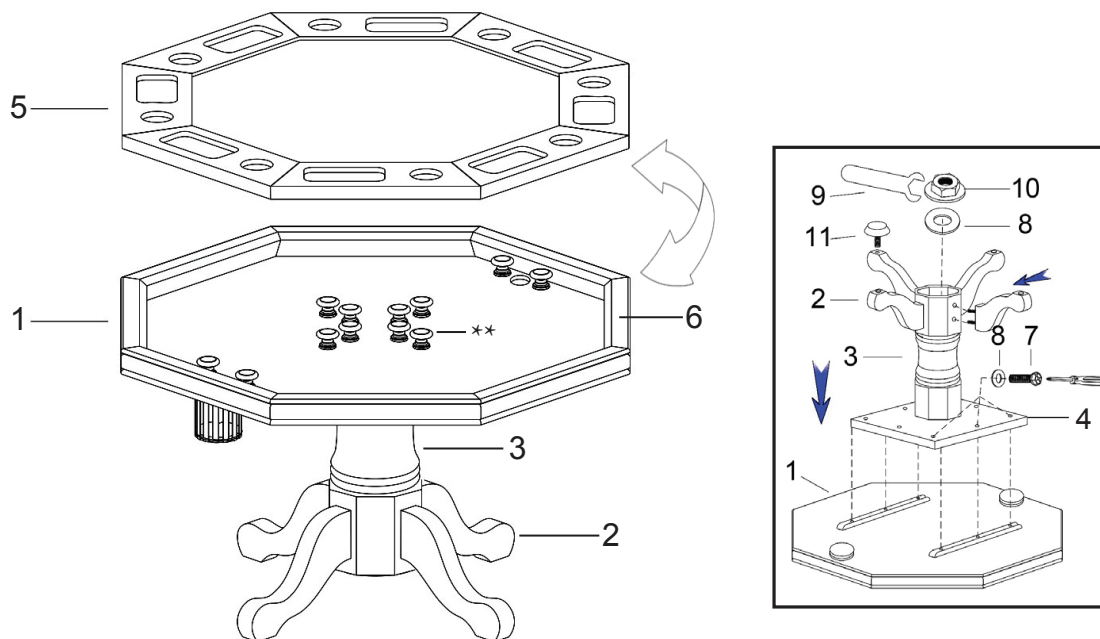







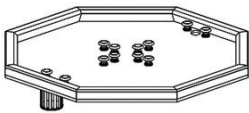

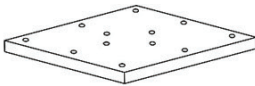
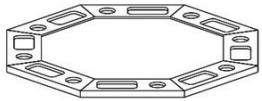
liste des pièces

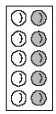

**Les butoirs (obstacles) de rechange rouges sont disponibles sous le NGP23221 et les butoirs blancs sous le NGP23231

PIÈCES

illustrations non à l'échelle

#1 NGP23001  STRUCTURE PRINCIPALE 1 pièce	#2 NGP23011  PIED 4 pièces	#3 NGP23021  PIÉDESTAL 1 pièce	#4 NGP23031  PLAQUE 1 pièce	#5 NGP23041  DESSUS DE TABLE 1 pièce
#6 NGP2305  PROTECTEUR DE TABLE 8 pièces	#7 NGP23311*  BOULON 6 pièces	#8 NGP23311*  RONDELLE PLATE 18 pièces	#9 NGP23311*  CLÉ 1 pièce	#10 NGP23311*  ÉCROU 12 pièces
#11 NGP23191  PIED DE NIVELEUR 4 pièces	#12 NGP5698  BOULES DE BILLARD À OBSTACLE 1 ensemble	#13 NGP5699  QUEUE DE BILLARD À OBSTACLE 2 pièces	#14 NGP5077  CRAIE 2 pièces	#15 NGP5073  BROSSE 1 pièce

***TROUSSE DE QUINCAILLERIE – NG23311 inclut les pièces 7, 8, 9 et 10**

CHAISE DE POKER 3-en-1 CHÊNE FONCÉ - NG2351C



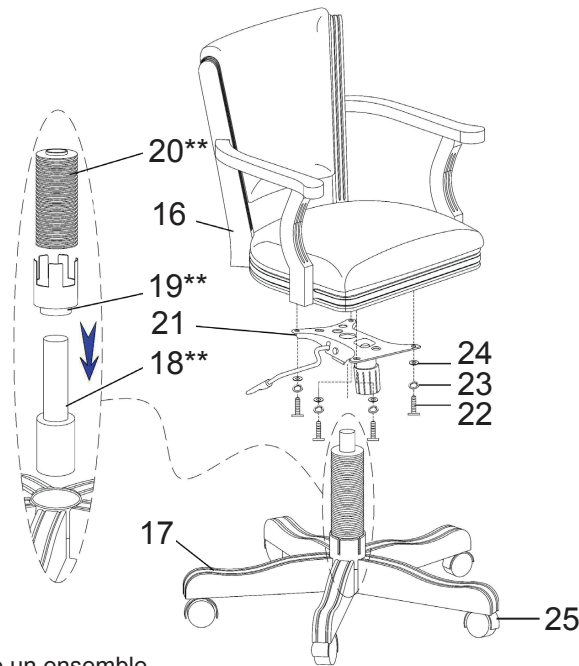





liste des pièces

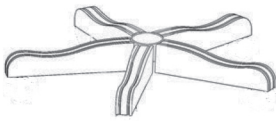

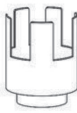
** Pièces 18, 19 et 20 sont emballés comme un ensemble

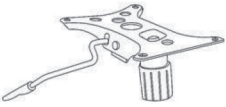
PIÈCES

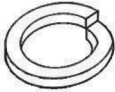
illustrations non à l'échelle

<p>#16 NGP23441</p>  <p>FAUTEUIL 1 pièce</p>	<p>#17 NGP23291</p>  <p>BASE DU FAUTEUIL 1 pièces</p>	<p>#18 NGP2324</p>  <p>CYLINDRE PNEUMATIQUE 1 pièce</p>	<p>#19 NGP2324</p>  <p>COUVERCLE DE LA BASE 1 pièce</p>	<p>#20 NGP2324</p>  <p>SOULEVEZ LE COUVERCLE 1 pièce</p>
<p>#21 NGP2327</p>  <p>LEVIER D'AJUSTEMENT 1 pièces</p>	<p>#22 NGP23451*</p>  <p>BOULON 4 pièces</p>	<p>#23 NGP23451*</p>  <p>RONDELLE DE BLOCAGE 4 pièces</p>	<p>#24 NGP23451*</p>  <p>RONDELLE PLATE 4 pièce</p>	<p>#25 NGP2330</p>  <p>ROULETTE 5 pièces</p>

*TROUSSE DE QUINCAILLERIE – NGP23451 includes parts 22, 23 & 24

TABLE DE POKER 3-en-1 NOYER - NG2366T



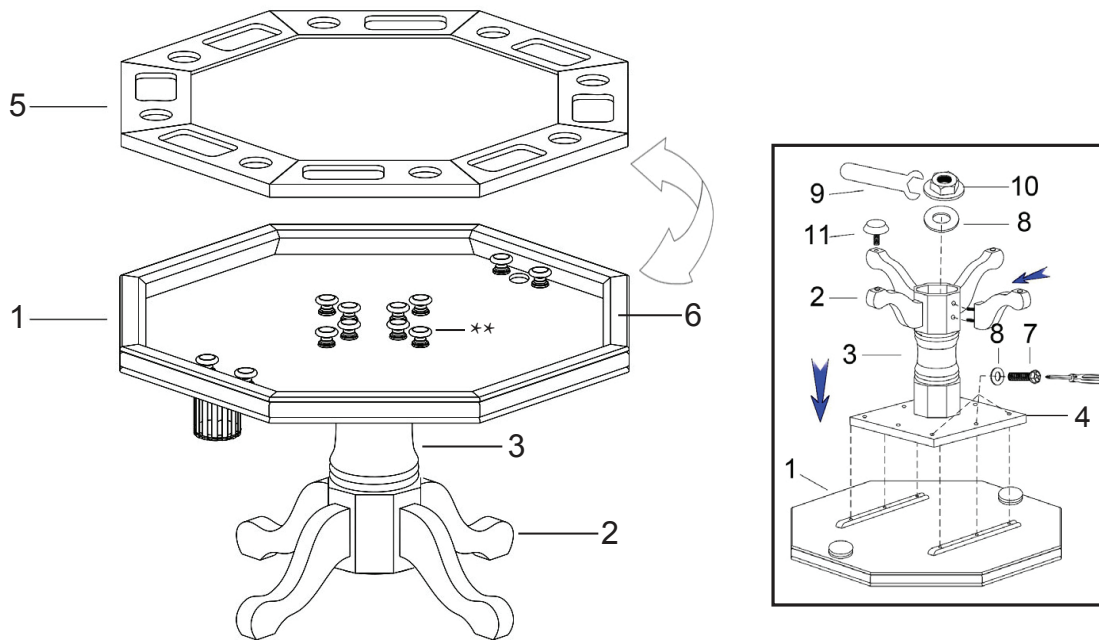







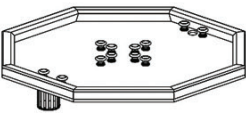

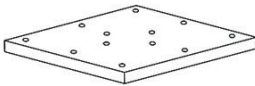
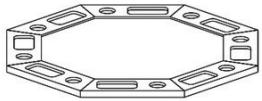
liste des pièces

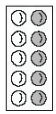

**Les butoirs (obstacles) de rechange rouges sont disponibles sous le NGP23221 et les butoirs blancs sous le NGP23231

PIÈCES

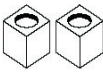
illustrations non à l'échelle

#1 NGP23071  STRUCTURE PRINCIPALE 1 pièce	#2 NGP23081  PIED 4 pièces	#3 NGP23091  PIÉDESTAL 1 pièce	#4 NGP23101  PLAQUE 1 pièce	#5 NGP23111  DESSUS DE TABLE 1 pièce
#6 NGP2305  PROTECTEUR DE TABLE 8 pièces	#7 NGP23311*  BOULON 6 pièces	#8 NGP23311*  RONDELLE PLATE 18 pièces	#9 NGP23311*  CLÉ 1 pièce	#10 NGP23311*  ÉCROU 12 pièces
#11 NGP23191  PIED DE NIVELEUR 4 pièces	#12 NGP5698  BOULES DE BILLARD À OBSTACLE 1 ensemble	#13 NGP5699  QUEUE DE BILLARD À OBSTACLE 2 pièces	#14 NGP5077  CRAIE 2 pièces	#15 NGP5073  BROSSE 1 pièce

***TROUSSE DE QUINCAILLERIE – NG23311 inclut les pièces 7, 8, 9 et 10**

CHAISE DE POKER 3-en-1 NOYER - NG2366T



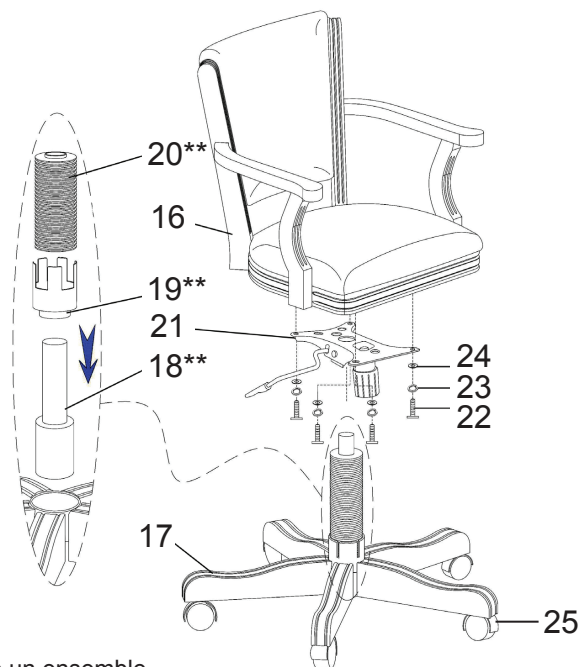





liste des pièces

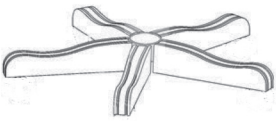

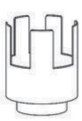
** Pièces 18, 19 et 20 sont emballés comme un ensemble

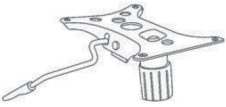
PIÈCES

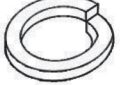
illustrations non à l'échelle

<p>#16 NGP23461</p>  <p>FAUTEUIL 1 pièce</p>	<p>#17 NGP23421</p>  <p>BASE DU FAUTEUIL 1 pièces</p>	<p>#18 NGP2324**</p>  <p>CYLINDRE PNEUMATIQUE 1 pièce</p>	<p>#19 NGP2324**</p>  <p>COUVERCLE DE LA BASE 1 pièce</p>	<p>#20 NGP2324**</p>  <p>SOULEVEZ LE COUVERCLE 1 pièce</p>
<p>#21 NGP2327</p>  <p>LEVIER D'AJUSTEMENT 1 pièces</p>	<p>#22 NGP23451*</p>  <p>BOULON 4 pièces</p>	<p>#23 NGP23451*</p>  <p>RONDELLE DE BLOCAGE 4 pièces</p>	<p>#24 NGP23451*</p>  <p>RONDELLE PLATE 4 pièce</p>	<p>#25 NGP2330</p>  <p>ROULETTE 5 pièces</p>

*TROUSSE DE QUINCAILLERIE – NGP23451 includes parts 22, 23 & 24

INSTRUCTIONS D'ASSEMBLAGE - TABLE

1. Fixez la PLAQUE (no 4) au PIÉDESTAL (no 3) à l'aide d'ÉCROUS (no 10) et de RONDELLES PLATES (no 8).

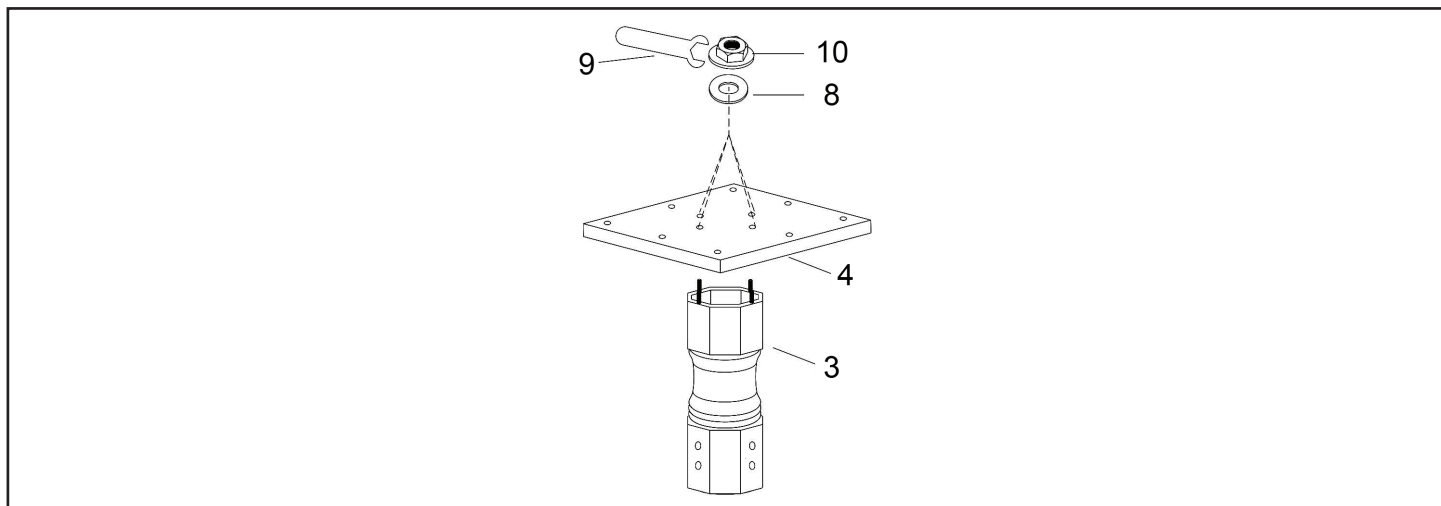

2. Fixez le PIÉDESTAL assemblé sous la STRUCTURE PRINCIPALE (no 1) à l'aide d'ÉCROUS et de RONDELLES PLATES (no 8).

3. Fixez les PIEDS (no 2) au PIÉDESTAL à l'aide d'ÉCROUS (no 10) et de RONDELLES PLATES (no 8).

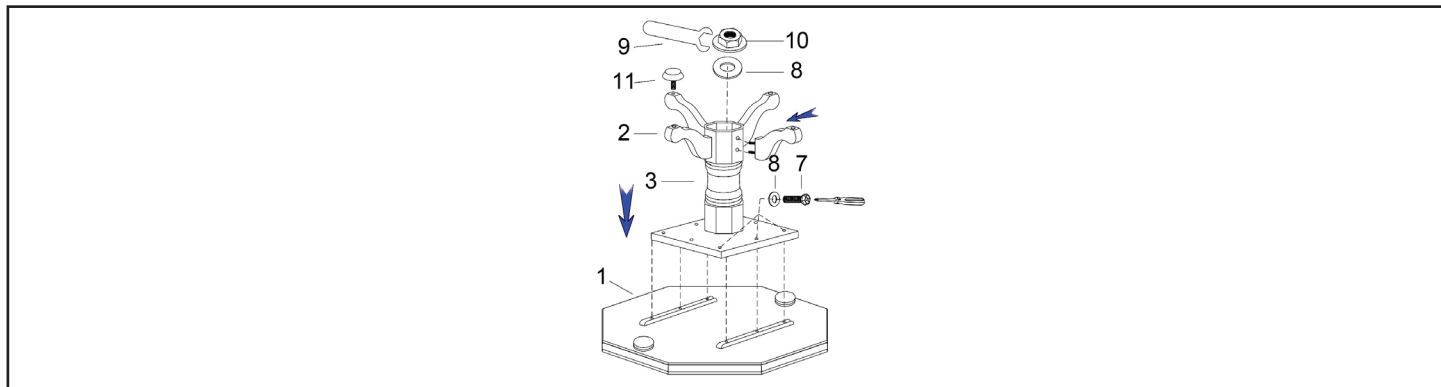

4. Retournez la table avec précaution. Installez le DESSUS DE TABLE (no 5) par-dessus la TABLE assemblée.

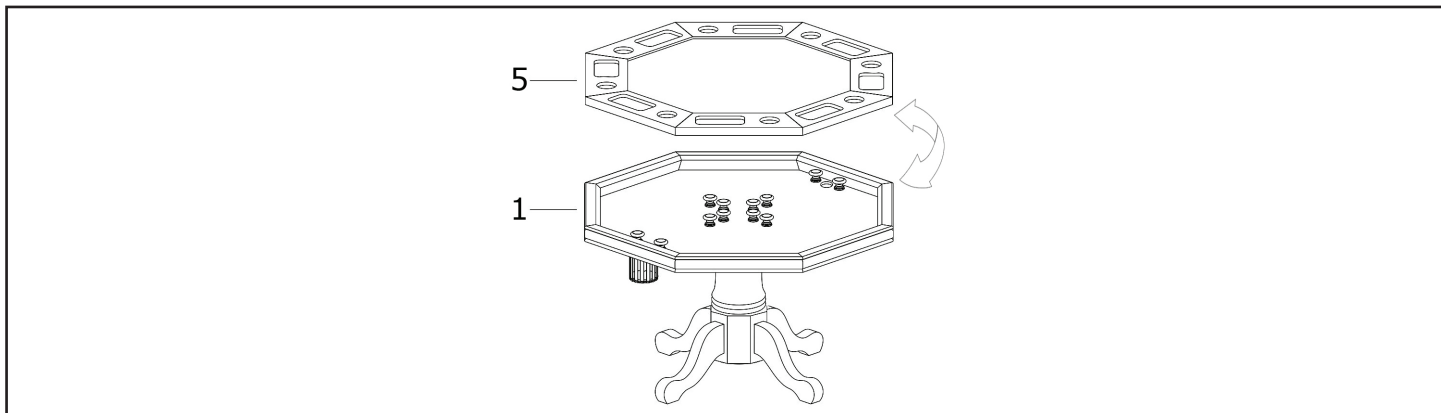

INSTRUCTIONS D'ASSEMBLAGE - FAUTEUIL

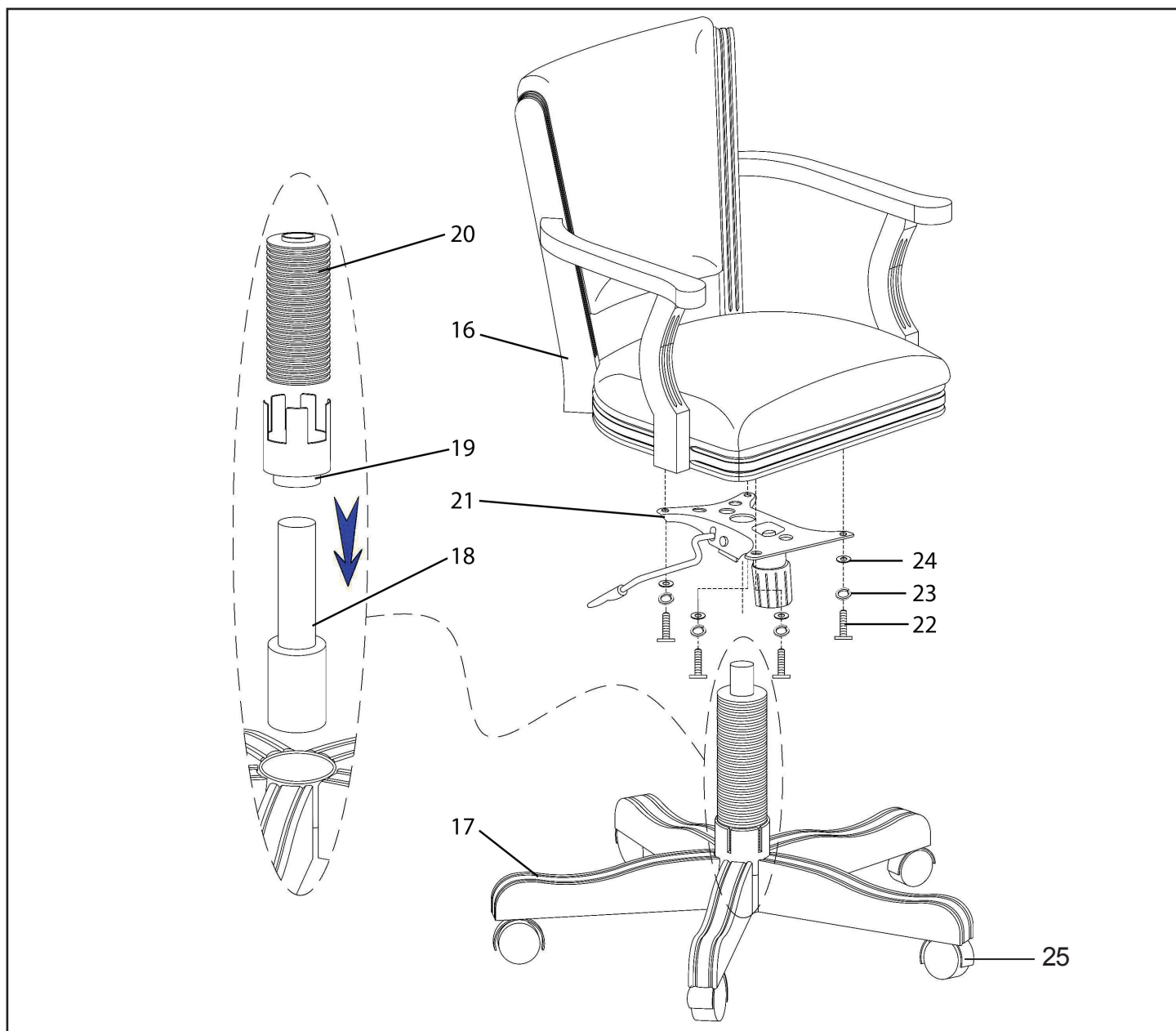

1. Insérez les ROULETTES (no 25) dans la BASE (no 17). Fixer CYLINDRE PNEUMATIQUE (no 18), COUVERCLE DE LA BASE (no 19) et SOULEVEZ LE COUVERCLE (no 20) à la BASE (no 17).
2. Fixer LEVIER D'AJUSTEMENT (no 21) au fond de FAUTEUIL (no 16) avec BOULON (no 22), RONDELLE DE BLOCAGE (no 23) et RONDELLE (no 24). Remarque: Le bouton de tension d'inclinaison doit faire face vers l'avant de la fauteuil.
3. Fixer FAUTEUIL assemblé à BASE assemblé - haut de CYLINDRE PNEUMATIQUE (no 18) entre dans le trou correspondant dans LEVIER D'AJUSTEMENT (NO 21).

GARANTIE LIMITÉE DE 180 JOURS

La garantie du produit est valide pour l'acheteur original en ce qui a trait aux pièces défectueuses ou à la main-d'œuvre pour une période de 180 jours de la date d'achat.

Cette garantie n'est couverte pas les dommages causés par accident, par modification, par une installation défectueuse ou tout autre événement hors du contrôle du fabricant. Tout défaut ou dommage résultant de la négligence ou d'une mauvaise utilisation annule cette garantie. La présente garantie ne couvre pas les égratignures ou les dommages attribuables à un usage normal.

Ce produit n'est pas destiné à un usage institutionnel ou commercial; le fabricant décline toute responsabilité pour une telle utilisation. Un usage institutionnel ou commercial annule cette garantie.

Cette garantie est non transférable et est expressément limitée à la réparation ou au remplacement du produit défectueux. Au cours de la période de garantie, le fabricant s'engage à remplacer et à réparer les pièces défectueuses sans frais pour l'acheteur. Les frais d'assurance et d'expédition ne sont pas couverts et sont à la charge de l'acheteur. Les frais de main-d'œuvre et les dépenses liées au déplacement, à l'installation ou au remplacement du produit ou de ses composantes ne sont pas couverts par cette garantie.

Le fabricant se réserve le droit de faire des substitutions de recours en garantie si la pièce n'est pas disponible ou obsolète.

Le fabricant décline toute responsabilité liée à la perte d'utilisation ainsi que tous les autres coûts directs ou indirects, frais ou dommages encourus par le consommateur qui aurait été causés par une autre utilisation. L'utilisateur assume tous les risques de dommage résultant de l'utilisation de ce produit.

Cette garantie tient lieu expressément de toute autre garantie, exprimée ou implicite, y compris les garanties de qualité marchande ou d'adaptation à un emploi particulier dans la mesure permise par les lois fédérales ou provinciales. Ni le fabricant, ni aucun de ses représentants n'assument aucune autre responsabilité en rapport avec ce produit.

Toute réclamation doit être faite par le détaillant où le produit a été acheté. Une facture ou autre preuve d'achat est nécessaire pour traiter toutes les réclamations de garantie. Le numéro de modèle et les numéros de référence figurant dans les instructions d'assemblage seront exigés lors de la soumission de demande de pièces ou de recours en garantie.

Pour plus d'information ou pour toute question, veuillez téléphoner au 1 800 759-0977.